

CATÁLOGO GENERAL
2025



INDEX[®]
A PERFECT FIXING

A
PERFECT
FIXING

 02
PRESENTACIÓN

 16
NOVEDADES

CATÁLOGO GENERAL 2025

 18
ÍNDICE

 132
ACCESORIOS DE
EMPARRADO

 226
TORNILLERÍA
NORMALIZADA

 302
SISTEMAS DE INSTALACIÓN
Y FIJACIONES PARA PLACAS
SOLARES

 36
FIJACIONES
METÁLICAS

 136
FIJACIONES Y ACCESORIOS
PARA PLACA DE YESO

 244
BROCAS, PUNTAS
Y ACCESORIOS

 320
SISTEMAS DE FIJACIÓN
RÁPIDA EN VIGA

 76
FIJACIONES
QUÍMICAS

 144
FIJACIÓN
DIRECTA

 252
ABRAZADERAS
METÁLICAS PESADAS

 324
VARILLA ROSCADA Y
ACCESORIOS DE FIJACIÓN

 92
FIJACIONES
PLÁSTICAS

 154
TORNILLOS PARA
CUBIERTAS Y FACHADAS

 264
ABRAZADERAS
METÁLICAS LIGERAS

 332
FIJACIÓN SANITARIOS
Y CLIMATIZACIÓN

 104
FIJACIONES Y ACCESORIOS
PARA SISTEMAS DE
AISLAMIENTO TÉRMICO (SATE)

 166
TORNILLOS BROCA,
ROSCA CHAPA Y PVC

 274
SISTEMAS PROTECCIÓN
CONTRA INCENDIOS

 338
**easy
kits**
EASYKITS

 108
FIJACIONES PARA
MATERIALES HUECOS

 184
TORNILLOS
PARA MADERA

 276
SOPORTES
DE CANALÓN

 344
INOX
GAMA
INOX

 114
REMACHES

 206
PUNTAS, ALCAYATAS
Y HEMBRILLAS

 279
ABRAZADERAS
PLÁSTICAS

 376
01
02
03
CARACTERÍSTICAS
TÉCNICAS

 120
ACCESORIOS PARA CABLE
CADENA Y CERCADOS

 218
CONECTORES
DE MADERA

 290
PERFILERÍA
Y SOPORTACIÓN

 440
ÍNDICE
POR REFERENCIAS



Una fijación perfecta para tu negocio

En INDEX® ofrecemos soluciones globales de fijación adaptadas a las necesidades de tu actividad, sin importar el tamaño de tu negocio.

Nuestra experiencia como fabricantes y proveedores industriales de sistemas de fijación nos permite garantizar la calidad y la personalización de nuestros productos.

Pero somos mucho más que eso. Somos un numeroso equipo humano en continua investigación, desarrollo e innovación.

Nuestro objetivo:

CONSEGUIR UNA FIJACIÓN PERFECTA.





¿Por qué INDEX® es una **fijación perfecta** para tu negocio?

En INDEX® creemos que no hay imposibles cuando se trata de perseguir la perfección. Por eso realizamos continuas inversiones en nuevos productos, homologaciones, procesos productivos y medios tecnológicos para responder a todas las demandas del mercado.



Estas son sólo algunas de las razones por las que INDEX® marca la diferencia:



DISPONIBILIDAD Y AMPLIA GAMA DE PRODUCTO

Más de 10.000 referencias con stock garantizado.



SOMOS EXPERTOS FABRICANTES

Más de 40 años fabricando sistemas de fijación nos permite garantizar la máxima calidad en nuestros productos, el mejor servicio y un coste global competitivo.



PRESENCIA INTERNACIONAL

Somos una empresa global, con ventas en más de 90 países en los 5 continentes y con instalaciones en España, China y México.



SERVICIO DE CALIDAD AL CLIENTE

Nuestros clientes son el centro de todo lo que hacemos. Disponemos de un equipo de más de 350 personas a su servicio.



TRABAJAMOS CON EL CANAL DISTRIBUIDOR

Vendemos a través del canal distribuidor, lo que nos permite conocer el mercado de primera mano.



CALIDAD CERTIFICADA

Contamos con los certificados y homologaciones más importantes, verificando que todos nuestros productos cumplan los más altos estándares de calidad.



SERVICIOS DIGITALES

Ayudamos a nuestros clientes en el proceso de digitalización de su negocio.



ASESORAMIENTO TÉCNICO Y SERVICIOS DE INGENIERÍA

Apoyamos a nuestros clientes y a sus clientes en el diseño y cálculo de fijaciones, visitas a obra conjunta y formaciones técnicas sobre temas relacionados con el mundo de la fijación.



INDEX SPACE STUDIO

Trabajamos en el diseño e implantación de expositores en el punto de venta de nuestros clientes.



Disponibilidad y amplia gama de producto

Ponemos a tu disposición más de 10.000 referencias en anclajes, tornillos, abrazaderas y sistemas de instalación, con un stock permanente garantizado en nuestros más de 45.000m² de instalaciones en España, China y México.



Más info:



Somos expertos fabricantes

Más de 40 años de experiencia que, junto con el control total del proceso productivo, nos permiten garantizarte la máxima calidad en nuestros productos, el mejor servicio y un coste global competitivo.



Más info:



Presencia internacional

Tenemos clientes en más de 90 países en los 5 continentes y contamos con instalaciones en España, China y México. Nuestros productos están presentes en los proyectos de construcción más importantes a nivel internacional.



Más info:





Servicio de calidad al cliente

Para garantizarte una fijación perfecta, contamos con un equipo de más de 350 personas a tu servicio y unas instalaciones de más de 45.000 m² y 22.000 pallets de capacidad, garantizando un plazo de entrega de 24-48 horas y una respuesta rápida a cualquier tipo de necesidad que puedas tener.



Más info:



Trabajamos con el canal distribuidor

Vendemos a través del canal distribuidor, lo que nos permite estar cerca de nuestros clientes y conocer el mercado de primera mano.

Para darte el mejor servicio, estamos presente en los canales más importantes, con gamas de productos adecuadas a cada uno de ellos y profesionales altamente cualificados para brindarte el mejor servicio.



Más info:





Calidad Certificada

La calidad en INDEX® es un compromiso con todos y cada uno de nuestros clientes. Un sello de calidad certifica, por un lado, que el camino recorrido es el adecuado, pero por otro sella una alianza con nuestros clientes debido a nuestra firme intención de seguir avanzando en ese camino.

Avalados por la certificación ISO 9001, mantenemos el compromiso de calidad con nuestros clientes. Además, nuestras certificaciones y homologaciones proceden de los principales organismos oficiales y de instituciones con el mayor prestigio mundial.

Más info:



Contamos con las siguientes homologaciones en nuestros productos:



Evaluación Técnica Europea



Conformidad Europea



Homologación Sísmica



ICC-ES®



Resistencia al fuego



Evaluación Técnica Europea



Homologación FM



Leadership in Energy and Environmental Design



Emisiones VOC reducidas



Water Regulations Advisory Scheme



Vds



Conformidad Reino unido



GEV - EMICODE®

PAHs

PAHs



REACH

RoHS

RoHS

Nuestro compromiso de calidad a través de la certificación TÜV CERT garantiza que INDEX® ha implementado un sistema de gestión según la norma ISO 9001:2015





Servicios Digitales

OPTIMIZAMOS PROCESOS, POTENCIAMOS TU NEGOCIO

En INDEX® entendemos la importancia que tiene la digitalización en el éxito de tu negocio.

Por ello, ponemos a tu disposición nuestros servicios digitales desarrollados para potenciar tu presencia online y ayudarte a liberar tu tiempo, reducir errores y sacar provecho de la información que tienes disponible.

Más info:



1 INTEGRACIÓN DE SISTEMAS

Integra tu ERP con INDEX® y automatiza la gestión de pedidos, facturas y albaranes.



4 RETAIL MEDIA MARKETING

Ofrecemos contenido multimedia y servicios de acompañamiento de marketing diseñados para fortalecer no solo tu presencia en línea, sino también el rendimiento general de tu negocio en el entorno digital.



2 E-COMMERCE

Tienda online disponible las 24 horas del día, durante todo el año, para comprar con autonomía y sin esperas. Adquiere productos a tu propio ritmo y accede fácilmente a toda la información actualizada sobre pedidos, inventario y productos.



5 BASES DE DATOS SECTORIALES

A través de nuestra presencia en BBDD sectoriales, ofrecemos el acceso a información actualizada sobre nuestros productos y facilitamos su integración con tus sistemas para que puedas utilizarlos de manera efectiva en todos tus canales.



3 RETAIL CONNECT

Conectamos nuestra página web con el e-commerce o las tiendas físicas de nuestros clientes para potenciar sus ventas. De esta manera, el cliente final puede consultar el listado de distribuidores con stock disponible en nuestra web y adquirir el producto en una tienda online o física.





Asesoramiento técnico y servicios de ingeniería

Te ofrecemos un completo asesoramiento técnico a través de un equipo de ingenieros especializados. Disponemos de un servicio S.A.T, software propio especializado y la más completa documentación técnica.

Cuenta con nosotros para el diseño y cálculo de fijaciones, visitas a obras y formaciones técnicas sobre todo lo relacionado con el mundo de la fijación.



Más info:



1 SERVICIOS DE INGENIERÍA Y REALIZACIÓN DE CÁLCULOS

Desde INDEX® queremos ofrecer el servicio más integral a nuestros clientes. Además de proporcionarles las mejores soluciones en fijaciones y anclajes, nuestro equipo de ingenieros especializados, asesora técnicamente a todos nuestros clientes. Además, disponemos de potentes herramientas de software para realizar los cálculos necesarios con total exactitud.

2 FORMACIÓN TÉCNICA

Nuestro departamento de ingeniería pone a tu disposición formaciones específicas y personalizadas en los diferentes temas relacionados con el mundo de la fijación: fijaciones metálicas o químicas, sistemas de instalación, normativas, realización de cálculos...

3 AMPLIA DOCUMENTACIÓN TÉCNICA DISPONIBLE

En ocasiones se requiere de una información técnica completa de los productos, donde se especifiquen conceptos técnicos con cierta complejidad. Por ello, ponemos a tu disposición un amplio portfolio de documentación técnica de todos los productos INDEX®: fichas técnicas, fichas de seguridad, DoP, homologaciones, certificaciones, vídeos de instalación... Y todo ello, en nuestra web y a un simple clic.

4 DOCUMENTOS CAD Y RECURSOS CYPE

En INDEX queremos facilitar el proceso a la hora de realizar un proyecto y de proponer las mejores soluciones. Disponemos de una biblioteca donde se reúnen los archivos CAD de nuestros productos.

5 SOFTWARE ESPECIALIZADO

Los softwares de diseño y cálculo de INDEX® son una excelente herramienta para completar los proyectos. De gran ayuda para ingenieros, estructuristas o instaladores profesionales.

Ofrecen infinidad de parámetros para poder medir y calcular cualquier proyecto y siempre con la garantía de estar cumpliendo con los estándares que exigen las homologaciones y certificaciones



INDEXcal

SOFTWARE DE CÁLCULO DE ANCLAJES

Adecuado para que los diseñadores de soluciones estructurales cumplan con los requisitos del Eurocódigo 2, parte 4. Comprueba de forma rápida y detallada todos los anclajes de nuestro catálogo en base a parámetros de entrada del usuario, indicando su adecuación o no a las mismas.



INDEXwood

SOFTWARE DE DISEÑO PARA EL CÁLCULO DE ESTRUCTURAS DE MADERA

Permite realizar cálculos de fijaciones estructurales en madera con tirafondos de manera sencilla, de acuerdo con el Eurocódigo 5 (norma EN 1995-1-Incluye todos los artículos de nuestro catálogo con marcado CE).

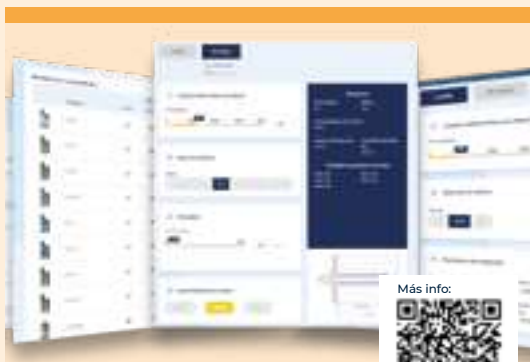

INDEXmor

SOFTWARE ONLINE PARA CÁLCULO DE MORTEROS QUÍMICOS

Aplicación web para calcular el número de cartuchos químicos necesarios en función de diferentes parámetros, tanto en ladrillo como en hormigón (varilla métrica y barra corrugada).



INDEX Solar Fixing

APLICACIÓN ONLINE PARA LA INSTALACIÓN DE PLACAS SOLARES

Aplicación web para conocer qué fijaciones y sistemas de instalación son necesarios para la correcta instalación de paneles solares en función de diferentes parámetros.



INDEX Space Studio

Servicio dedicado al diseño personalizado de expositores y su implantación en el punto de venta del cliente.

Se trata de un servicio único en el mercado, 100% personalizable según las necesidades específicas del cliente (producto, formato de packaging, rotación y/o tipología de negocio), con el objetivo de rentabilizar al máximo el espacio de venta.



Más info:



MUCHAS VENTAJAS PARA TU NEGOCIO

- **PERSONALIZABLE:** adaptamos la implantación a las necesidades de tu negocio.
- **IMPLANTACIONES 100% OPTIMIZADAS:** obtenemos el máximo aprovechamiento del espacio en el punto de venta.
- **MÚLTIPLES SOLUCIONES EXPOSITIVAS:** cuenta con una amplia gama de soluciones expositivas, como góndolas, murales, cabeceras, islas y expositores promocionales.
- **CALIDAD Y SEGURIDAD:** trabajamos con mobiliario de alta calidad que garantiza robustez y una máxima seguridad.
- **VERSATILIDAD:** expositores compatibles con todos los productos y empaquetados de INDEX®.
- **PROCESO DE REPOSICIÓN OPTIMIZADO:** el mobiliario y los packaging garantizan la máxima ergonomía y practicidad para facilitar la reposición y el mantenimiento del lineal.
- **MÁXIMA VISIBILIDAD DEL PRODUCTO:** expositores diseñados para mejorar la decisión de compra del cliente final.

INDEX SPACE STUDIO EN 3 PASOS

1

ANÁLISIS

El equipo comercial de INDEX® analiza junto al cliente sus necesidades, según el espacio disponible, productos a incorporar, tipo de packaging, entre otras opciones.

2

DISEÑO y PRESENTACIÓN

Con la información obtenida, nuestro equipo realiza una simulación 3D del lineal y un planograma, reflejando la colocación óptima del surtido seleccionado.

3

MONTAJE

El equipo especializado de montadores INDEX® se ocupa del montaje inicial íntegramente, que contempla la instalación del mobiliario, la ubicación del producto y la instalación del merchandising.

NUESTRO SERVICIO VA MÁS ALLÁ

Una vez realizada la implantación, aseguramos una revisión regular de cada lineal implantado, proponiendo posibles mejoras, manteniéndolo de forma óptima y actualizada y facilitando el trabajo de los reponedores.

Lineales

GÓNDOLA



BALDAS INCLINADAS

Mejora la visualización de todos los productos. Recomendables para formatos de venta en caja ventana y venta INDEXmix.



GAVETAS GRANEL

Disponibles en metal y en plástico reciclado. Ideales para la presentación de productos a granel.



GANCHOS

Disponibles en 30, 40 y 50 cm. Recomendables para la colocación de blisters y productos EASYkits.



BALDAS RECTAS

Indicadas para la presentación de productos pesados como cajas profesionales, botes. Combinadas con separadores es perfecto para productos químicos, siliconas o espumas de poliuretano.

EXPOSITORES PROMOCIONALES Y OTROS

ISLA



Posibles combinaciones. Medidas por módulo:
100 x 50 x 150 cm (A x F x H)

3 módulos
100 x 150 x 150 cm

4 módulos
100 x 200 x 150 cm

6 módulos
100 x 300 x 150 cm

8 módulos
100 x 400 x 150 cm

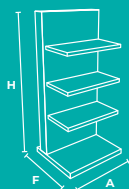

MEDIDAS DISPONIBLES EN STOCK

para expositores góndola/mural, cabeceras e islas:

- A: 100 cm.
- H: 165, 195 and 240 cm.

Otras medidas disponibles **bajo pedido**.

(Plazo de entrega de 4 semanas):

- A: 50, 70, 85 and 130 cm.
- H: 135, 150, 225 and 255 cm.
- F: 50 cm.

Packaging

Conocedores de que cada usuario requiere unas necesidades concretas a nivel de cantidad y embalaje, en INDEX® hemos desarrollado diferentes alternativas para poder satisfacer a cada uno de ellos.

Todos nuestros embalajes están fabricados con materiales reciclables, sostenibles y respetuosos con el medioambiente.

Facilitamos la identificación y selección de los productos gracias a la codificación de color en las etiquetas.



CAJA PROFESIONAL

Preparada para los trabajos más exigentes gracias a su cartón reciclado de alta resistencia.



CAJA CON VENTANA

Visual, atractiva. Recomendado para implantar en lineales con autoventa.



BLÍSTER & EASYKits

La mejor solución para cuando el cliente requiere comprar pocas cantidades.



BOTES DE PLÁSTICO

Son la solución perfecta para los grandes instaladores. Facilitan el manipulado en obra y cuentan con un atractivo diseño.



GRANEL

Disponible para anclajes, tornillos, abrazaderas y bridas. Una buena solución para implantaciones con espacio de autoventa.

Visual merchandising































En INDEX ponemos a disposición de nuestros distribuidores una amplia gama de soportes para promocionar y comunicar nuestros productos en el punto de venta, como cabeceras de lineales, pósters, tótems, stickers, y ¡mucho más!

Más info:



AMPLIAMOS GAMA

SISTEMAS DE INSTALACIÓN Y FIJACIONES PARA PANELES SOLARES

	CL-CCS Clip para conducción de cables. Simple		KFS-RV Varilla roscada para instalación con anclaje químico. Inox A2
	CL-EX Herramienta de extracción para clips de fijación solar CL		KT-PSC Kit para instalaciones solares. Triangular con perfil de aluminio PSE-C. Fijación ensamblada
	CL-GS Grapa para fijación de paneles solares por clipado		BBI-SDS Broca SDS-Plus de bajo impacto
	CL-PG Goma de separación entre paneles para clip CL-GS		GM-N Galga de aluminio para marco. Negra
	CL-SC Clip para la sujeción de conexiones entre cables		MS-IS Membrana impermeabilizante híbrida
	CL-TT Clip para cable de toma tierra sin tornillos		PGS-N Perfil grapa. Negro
	GS-PI Gancho salvateja para teja de pizarra. Inox A2		PMO Placa para tornillo doble rosca. Inox A2
	GS-TC Gancho salvateja ajustable para teja curva. Inox A2		PSA-A Perfil de aluminio con alas
	GS-TP Gancho salvateja para teja plana. Inox A2		PSE-A Perfil de aluminio para fijación ensamblada
	GS-TU Gancho salvateja ajustable para teja universal. Inox A2		PSE-C Perfil de aluminio para fijación ensamblada lateral
	KFR-SCN Grapa fijación rápida. Negra		PST 3 + ARVUL A2 Tornillo con punta broca estándar #3 con recubrimiento ATLANTIS C4-M y arandela inox A2
	KFR-SS Grapa fijación simple		PST 5 + ARVUL A2 Tornillo con punta broca extra larga #5 con recubrimiento ATLANTIS C4-M y arandela inox A2
	KFS-FC Conector cruzado para fijación lateral. Perfil PSE-C		TPA-A Triángulo abierto de aluminio premontado. Válido para guías PSE-C y PSE-A
	KFS-FI Conector cruzado para fijación inferior. Inox A2		TPA-C Triángulo cerrado de aluminio premontado. Válido para guías PSE-C y PSE-A
	KFS-MA Espárrago doble rosca. Inox A2		TP-PS Tapa lateral para perfil solar

NUEVOS PRODUCTOS | NUEVAS MEDIDAS

T-FUX E

Taco de nylon universal de alto rendimiento. Taco cabeza cilíndrica. Tornillo cabeza hexagonal. Huella TX. Zincado. Homologado ETE



PAGE 94

ISO-7380

Tornillo allen con cabeza redonda de acero calidad 10.9. Zincado



PAGE 242

SL-PE

Anclaje para grandes cargas en hormigón. Homologado ETE Opt.1. Espárrago



PAGE 65

ABE A4 BIMETAL

Tornillo autotaladrante inoxidable bimetálico A4 con cabeza hexagonal



PAGE 158

AMPLIAMOS GAMA

ANCLAJE DE FIJACIÓN DIRECTA EN HORMIGÓN

	TXA NEW Bimetal (cuerpo inoxidable A4 y punta de acero al carbono). Cabeza avellanada
	TXP NEW Bimetal (cuerpo inoxidable A4 y punta de acero al carbono). Cabeza alomada
	TXT NEW Bimetal (cuerpo inoxidable A4 y punta de acero al carbono). Cabeza Truss
	THE NUEVAS MEDIDAS Recubrimiento ATLANTIS C3-H. Cabeza hexagonal
	TFA NUEVAS MEDIDAS Recubrimiento zincado. Cabeza avellanada
	TFE NUEVAS MEDIDAS Recubrimiento zincado. Cabeza hexagonal
	TFF NEW Recubrimiento zincado. Rosca hembra métrica
	TFP NEW Recubrimiento zincado. Cabeza alomada
	TFT NEW Recubrimiento zincado. Cabeza Truss
	TFY NEW Recubrimiento zincado. Argolla
	DO-TFY NEW Útil de colocación para TFY



NUEVA GAMA ANCLAJE METÁLICO DE GOLPE | NA

NA-C Cabeza plana	NA-E Espárrago	NA-F Rosca hembra	NA-G Gancho	NA-R Argolla
				







































NUEVA GAMA ACCESORIOS DE EMPARRADO











GO-AN Goma ancla de caucho 100% sintético	MC-OV Macarrón. Hilo de plástico tubular flexible para atado manual. Ovillo de 1kg	MC-MA Macarrón. Hilo de plástico tubular flexible para atado manual. Madeja de 2kg	MC-PR Macarrón. Hilo de plástico tubular flexible para atado manual. Precortado	TA-TU Tensor Universal 2 canales para todo tipo de alambres	TA-TF Tensor final de línea 1 canal para la terminación de los alambres a los postes
					

ÍNDICE



Fijaciones metálicas

MTP		37				HP	53	
MTP-A4		37				HPZ	53	
MTP-AT		38				HP TP	53	
MTP-X		38				HR	54	
MTP-G		39				HEA	54	
MTH		40				HEA + ARVUL	54	
MTH-AT		41				NEW SL-PE	55	
MTH-A2		42				SL-PT	55	
MTH-A4		42				SL-PC	55	
MTA		43				CH-TO	57	
DO-MT		45				CH-A2	57	
TP-MT BL		45				CH-8.8	58	
TP-MT NE		45				CH-8.8 E	58	
TWA		45				CH-PL	58	
TXE		47				CH-PI	58	
NEW TXA		47				CH-INB	59	
NEW TXP		47				CH-INN	59	
NEW TXT		47				CH-ES	59	
THE		48				CH-GA	60	
THA		49				CH-GE	60	
THP		49				CH-GF	60	
THT		49				CH-GF A2	60	
TFE		50				CH-AR	61	
NEW TFA		51				CH-AF	61	
NEW TFP		51				CH-AF A2	61	
NEW TFT		51				HE-HO	63	
NEW TFY		51				HE-A4	63	
NEW DO-TFY		52				HE-CL	63	
TFN		52				HE-C4	63	
TFS		52				HE-HC	64	
TFF		52				HE-NO	64	
TFM		53				HE-NS	64	
						HE-HO SDS	64	

HE-HC SDS	64		
EXP	65		
EXP-C	65		
NEW EXP-SDS	65		
NEW EXP-SDS C	65		
HC 	65		
TALA 	66		
TA-ME	66		
AN-CU 	66		
TC-MA	66		
NEW NA-C	67		
NEW NA-E	67		
NEW NA-F	67		
NEW NA-G	67		
NEW NA-R	67		
AC-CA	68		
AC-CI	68		
AC-TO	68		
AC-ES	68		
AC-GA	68		
AC-AR	68		
ZA-CA	69		
ZA-TO	69		
ZA-ES	69		
ZA-GA	69		
ZA-GF	69		
ZA-AR	70		
ZA-AF	70		
HI-CA	70		
HI-CI	70		
HI-TO	70		
HI-GA	71		
HI-AR	71		

EPS	71	
TRA	71	
AVR	72	
AVC	72	
AN-23	72	
AN-51	72	
AN-50 CT	72	
TC-SO 2	73	
TC-SO 8	73	
AN-TA	73	











Fijaciones químicas

NEW MO-PU 	77			
NEW MO-PUP 	77			
NEW MO-PSU	77			
MO-P+ 	77			
MO-PS+ 	78			
MO-PSP+ 	78			
MO-V 	78			
NEW MO-VSF	78			
NEW MO-VH	79			
NEW MO-VHW	79			
MOPURE 	79			
MOPUR3 	79			
MOPISTO	80			
MOPISPR	80			
MOPISSI	80			
MOPISPUR6	80			
MOPISNEU	80			
MOPISP3	80			
MOBOMBA	80			
MORCANU	80			
MORCAPU	80			
MORCEPKIT	80			















ÍNDICE

MO-TN	80			
MO-ES	80			
MO-TR	80			
MO-TM	80			
MO-TL	80			
MO-PC	80			
CA-QU	81			
EQ-AC	81			
EQ-8.8	81			
EQ-A2	81			
EQ-A4	81			
MS-PR	83			
MS-TR	83			
MS-SF	83			
NEW MS-IS	83			
SI-PR	85			
SI-PRS	85			
SI-UNI	85			
SI-UNS	86			
SE-ACR	86			
MS-CA	86			
PU-SP	87			
PU-SC	87			
PU-TP	87			
PU-TPR	88			
PU-FP	88			
PU-FC	88			
PU-EP	89			
PU-CL	89			
PU-PI	90			
PU-PI 2	90			
PU-CA	90			
Fijaciones plásticas				
T-NUX A	93			
T-NUX A A4	93			
T-NUX E	93			
T-NUX E A4	94			
T-NUX T	94			
T-FUX E	94			
T-NUX	94			
TC-6A	95			
TC-6E	95			
TC-2A	95			
TC-SP	96			
TC-SP EP	96			
TC-A2	96			
TC-CC	96			
TC-CA	97			
TC-CA EP	97			
TN4S	98			
TN4S EP	98			
TN4S + AL-HA	99			
TN4S + AL-HC	99			
TN4S + AL-RO	99			
TN4S + DIN-571	99			
TN4S + TP-PO	99			
NEW TN4S + TP-PO Z	100			
TN4S + TP-PO EP	100			
TN4S-L	100			
TN4S-A	100			
TN4S-A EP	100			
MEDU	101			
TACON	101			
TACOL	101			
TACOL-A	101			





Fijaciones y accesorios para sistemas de aislamiento térmico (SATE)









AIS-C		104	
AIS-S		104	
AIS		104	
AIS-R		104	
AIS-W		105	
AIS-M		105	
AIS-AM		105	
TE		105	

Fijaciones para materiales huecos

























BA-ES		108	
NEW BA-NY		108	
BA-GA		108	
CA-BA		108	
PA-ES		109	
PA-GA		109	
CA-PA		109	
IN-CO		110	
IN-HE		110	
IN-SI		110	
INPIN		111	
INPIS		111	
KITINPIN		111	
ANCLA		112	
TAPLA NY		112	
TAPLA ME		112	
TAPLA ZK		112	

Remaches











RE-NO		114	
RE-IN		115	
RE-CA		115	
RE-BL		115	

RE-NE		116	
RE-FL		116	
TR-AV		117	
TR-CA		117	
TR-CR		117	
RM-MA		118	
RM-PA		118	
RM-EX		118	







Accesorios para cable, cadena y cercados

SJ-Z		120	
SJ-A4		120	
SJ-O		120	
SJ-PS		121	
SJ-PS A4		121	
SJ-PD		121	
SJ-PD A4		121	
TS-GA A4		122	
TS-GA A4		122	
TS-AA		122	
TS-AA A4		122	
TS-GG		123	
TS-GG A4		123	
TS-VS		123	
EV-H		124	
EV-H A4		124	
EV-M		124	
EV-M A4		124	
GR-Z		125	
GR-A4		125	
GD-Z		126	
GD-A4		126	
GI-A4		127	
GS-Z		127	















ÍNDICE







MQ-BS	127	
MQ-B	127	
CM-BP	128	
CM-BT	128	
CM-TA	128	
CM-TP	128	
CM-UN	128	
CM-TENSO	129	
CM-TENSOVE	129	
CM-TT	129	

Accesorios de emparrado





















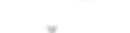





NEW TA-TF	132	
NEW TA-TU	132	
NEW TA-TU	132	
NEW MC-MA	133	
NEW MC-OV	133	
NEW MC-PR	133	

Fijaciones y accesorios para placa de yeso

PL-F	136	
PL-EP	136	
PL-CA	137	
PL-RA	137	
PL-TR	137	
CP-PA	138	
CP-GV	138	
CP-AC	138	
CP-MV	138	
OME	139	
MAB	139	
HO-CU	139	
HO-CR	139	
EMP	140	
CAB	140	



















ADU	140	
PCU	140	
SUS	141	
TR-BL	141	
TR-13	141	
TR-15	141	













Fijación directa

FP08GUN	144	
FP12GUN	144	
FP-IP	144	
FP-CG 08	145	
FP-CL 08	145	
FP-AP 08	145	
FP-C30	145	
FP-AM 08	145	
FP-CR 08 M6	146	
FP-CR 08 M8	146	
FP-PI 08	146	
FP-CG 12	146	
FP-CGD 12	146	
FP-CL 12	146	
FP-CLD 12	147	
FP-CT 12	147	
FP-PISCL08	147	
FP-PISPL08	147	
FP-PISCL12	147	
FP-PISCM12	147	
FP-PISCT12	147	
FG-GUN	148	
FG-GUNEL	148	
FG-CL	149	
FG-CLH	149	
OME	149	
FG-ARAM	149	



















FG-ARAM EP	150	
FG-PLET	150	
AB-PID	150	
FG-ABRA	150	
FG-ABRA	150	
FG-CAEL	151	
FG-CLCAR	151	
FG-IMAN	151	
FG-BAT	151	
FG-CAR	151	
FG-GAS	151	

Tornillos para cubiertas y fachadas



















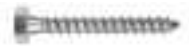

























DIN-7504-K	154	
DIN-7504-K A2	154	
DIN-7504-K + ARVUL	155	
DIN-7504-K CP + ARVUL	155	
DIN-7504-K RE	156	
DIN-7504-K RE + ARVUL	156	
DIN-7504-K RE NI + ARVUL	156	
AUTO	157	
AUTO + ARVUL	157	
ABE BIMETAL	157	
ABE BIMETAL + ARVUL	157	
NEW ABE A4 BIMETAL	158	
AUTO BIMETAL	158	
AUTO BIMETAL + ARVUL	158	
AUE	159	
AUE + ARVUL	159	
AUE NI + ARVUL	159	
PS 3	160	
PS 3 + ARVUL	160	

PS 3 + ARVUL A2	160	
PS 5	161	
PS 5 + ARVUL	161	
PS 5 + ARVUL A2	161	
NEW PST 3 + ARVUL A2	160	
NEW PST 5 + ARVUL A2	161	
FIBR	162	
TDR	163	
ARVUL	163	
ARVUL A2	163	
ARPAR	163	
ARPAR A2	163	
ATAP	163	











Tornillos broca, rosca chapa y PVC

DIN-7504-N HP Z	166	
DIN-7504-N HP A2	167	
DIN-7504-N HP N	167	
DIN-7504-N HP B	167	
DIN-7504-N HT	168	
DIN-7504-N HC	168	
DIN-7504-P HP Z	169	
DIN-7504-P HP N	170	
DIN-7504-P HT Z	170	
ABA	170	
ATA	171	
RS	171	
RS-A2	171	
BCP Z	172	
BCP A2	172	
BCP N	172	
BCP B	172	
BCP CB	172	
TAEZ	173	
TAEN	173	









ÍNDICE









DIN-7981 HP B	173		TP-A2	197	
DIN-7981 HP N	173		TR-PO	197	
DIN-7981 HP Z	174		DIN-571	198	
DIN-7982 HP Z	175		DIN-571 A2	199	
CP-Z	178		571 TR	199	
CP-A2	178		INV Z	199	
CP-B	178		INV A2	200	
CP-N	178		INV N	200	
PVC-10 Z	179		ESTRINV Z	200	
PVC-20 B	179		ESTRINV N	200	
PVC-20 Z	179		TRE-Z	201	
PVC-30	179		TRE-PV	201	
PVC-40 B	179		FS Z	201	
PVC-40 Z	180		FS 3009	201	
PVC-50 B	180		FS 3011	202	
PVC-50 Z	180		FS 5010	202	
PVC-70	180		FS 6005	202	
PVC-70 TP	180		FS 8004	202	
PVC-90	181		FS 8017	202	
PVC-VEK	181		FS 8019	203	
PVC-VEK 13	181		FS 9006	203	
PVC-VEK 10	181		FS 9010	203	
PVC-KOM 10	181		FS 9011	203	

Tornillos para madera

























TEX-BP	184	
TEX-ZP	185	
TEX-ZP	185	
TEX-ZT	187	
TEX-A2	187	
TEC-BT	189	
TEX-AB	189	
TP-PO B	192	
TP-PO Z	194	
TP-TO	196	













Puntas, alcayatas y hembrillas

AL-RE	206	
AL-PL	206	
AL-RO	207	
AL-RO B	207	
AL-HC	208	
AL-HC B	208	
AL-HA	209	
AL-HA B	209	
HC-RM	210	





















HA-RM	210	
PA-CP	211	
PA-CC	211	
GM-Z	212	
CF-B	212	
CF-B	212	
CF-B	212	
SV-C	212	

Conectores para madera









SO-UO	218	
SO-UR	218	
SC-EI	218	
SC-ED	218	
SC-LD	218	
SC-GA	219	
SC-RF	219	
SC-RG	219	
SC-AS	219	
SC-CE	219	
SC-OB	220	
SC-CD Z	220	
SC-CI	220	
SC-EM	220	
SC-ER	220	
SC-GE Z	221	
SC-MZ	221	
SC-PD	221	
SC-RE Z	221	
SC-LC Z	221	
PT-BR	222	
PT-EM	222	
PT-ET	222	
PT-OB	222	
PT-TT	222	

PT-UN	222	
AP-AR	223	
AP-AT	223	
AP-FL	223	
AP-FU Z	223	
AP-PD	223	
AP-PG	223	
AP-PT	224	
AP-UE Z	224	
AP-SB	224	
AP-EN	224	
VM-PF	224	













Tornillería normalizada

DIN-933	226	
DIN-933 A2	228	
DIN-931	229	
DIN-6921	230	
DIN-6921 A2	230	
DIN-912	231	
DIN-603/934	232	
DIN-603 A2	233	
DIN-608	233	
DIN-84	233	
DIN-7985	234	
DIN-963	235	
DIN-965	235	
DIN-934	236	
DIN-934 A2	236	
DIN-985	237	
DIN-985 A2	237	
DIN-6923	238	
DIN-6923 A2	238	
DIN-1587	238	
DIN-125	239	











ÍNDICE

DIN-125 A2	239	
DIN-9021	240	
DIN-9021 A2	240	
DIN-127	241	
DIN-127 A2	241	
TU-MA	241	
DIN-6798 A	242	
NEW ISO 7380	242	

Brocas, puntas y accesorios

















PU-PH	244	
PU-TO	244	
PU-OX	244	
PU-PO	245	
PU-CU	245	
BOCA	245	
PU-PM	246	
NEW PU-PMI	246	
ATAP	246	
TP-CR B	247	
TP-CR N	247	
TP-TP	247	















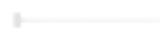







Abrazaderas metálicas pesadas

AB-RA	252	
AB-IA	252	
AB-IR	252	
AB-RE	253	
AB-RE V	253	
AB-RE A2	253	
AB-RE A4	254	
AB-RI	254	
AB-RI V	255	
AB-RI A2	255	
AB-RI A4	255	









AB-RI DES	256	
PA-EX	256	
CO-AR	256	
AB-ICP	256	
AB-AIS 13	257	
AB-AIS 19	257	
AB-AIS 30	257	
AB-AIS 40	257	
AB-GA	258	
AB-M8	258	
AB-ZI	258	
AB-ZI A2	259	
AB-SA	259	
AB-GP	259	

Abrazaderas metálicas ligeras

AB-M6	264	
AB-M6 Z	264	
AB-M6 A2	264	
AB-D6	265	
AB-D6 Z	265	
AB-6I	265	
AB-DI	265	
AB-M7 Z	266	
AB-D7 Z	266	
AB-7I Z	266	
AB-7ID Z	267	
AB-PI	267	
AB-PU	267	
AB-IP	268	
AB-SI	268	
AB-TO	268	
AB-SF	269	
AB-SF A2	269	

AB-SF IR	270		TACOBRI B	280	
AB-SF IRC	270		TACOBRI G	280	
AB-SF IRR	270		BN-DT	280	
CI-PE	270		BN-ID	282	
CI-PE A2	270		BN-PL	282	
CI-PE A2	270		BN-BA	282	
AB-CR	271		AB-IN	282	
AB-ITS	271		AB-ID	283	
AB-ITD	271		AB-GU	283	
AB-BU	271		AB-MUG	283	
AB-GM	272		AB-PR	284	
AB-GS	272		AB-MS	284	
AB-GD	272		AB-MD	284	



















Sistemas de protección contra incendios

AB-PE	274		AB-TS	285	
AB-CH	274		AB-TD	285	
AB-CI	274		AB-TC	285	
AN-CU	274		FI-CA AB	286	































































Soportes para canalones

TE-MO	276		FI-CA PS	286	
TE-GA	276		FI-CA PD	286	
TE-GR	276		FI-CA CL	286	
TE-PE	276		GR-NY BL	286	
			GR-NY N	286	
			GR-NY NT	286	

Abrazaderas plásticas

BN-N	279		GP-Z	292	
BN-B	279		GP-G	292	
BN-GR	280		GP-A2	292	
BN-VE	280		GP-PL	292	
BN-MA	280		GP-PVC	292	
BN-AM	280		GL-O	293	
BN-AZ	280		GL-O	293	
BN-RO	280		SP-Z	293	
TACOBRI N	280		SP-V	293	



























ÍNDICE

SP-H	293		PG-X	300	
SP-HX	294		AB-GX	300	
TO-GU	294		UN-CO	300	
TO-GR	294		SO-PG	300	
TU-GU	294		Sistemas de instalación y fijaciones para paneles solares		
TU-GRA	294		KFR-SC	302	
EG-Z	295		NEW KFR-SCN	302	
EG-A2	295		NEW KFR-SS	302	
PU-Z	295		NEW CL-GS	302	
PG-Z	295		PGS-A	302	
PG-A2	295		NEW PGS-N	303	
SO-TP	295		PGS-N	303	
GP-X 21	296		NEW GM-N	303	
GP-X 41	296		GP-XS	303	
SP-X	296		NEW GP-XSB	303	
SP-RX	296		EMP-XS	304	
SP-UX	296		NEW EMP-XSD	304	
PR-X	297		GP-VD	304	
RE-SX	297		PSA-A	304	
SO-TP	297		PSA-UN	304	
TG-X	297		NEW PSA-UNT	305	
TO-GRX	297		PSA-AV	305	
TU-GX	298		PSE-A	305	
TU-MU	298		PSE-UN	305	
TU-RX	298		NEW PSE-UNT	305	
TU-RXA	298		PSE-C	306	
EG-X	298		NEW PSE-CB	306	
SC-RX	299		PSE-CUN	306	
EMP-X	299		NEW PSE-CUNT	306	
RT-X	299		DIN-6921 A2	307	
UN-PX	299		DIN-603 A2	307	
UN-EX	299				
UN-TX	300				





DIN-6923 A2	307		PMO-LK	313	
DIN-127 A2	307		MO-TL	314	
TP-PS	307		MO-PC	314	
KFS-FI	308		DIN-7504-K RE NI + ARVUL	314	
KFS-FL	308		NEW PST 3 + ARVUL A2	314	
KFS-FL	308		NEW PST 5 + ARVUL A2	314	
TU-RX A2	308		TAC + ARVUL	315	
NEW CL-CCS	308		TAC BIMETAL + ARVUL A2	315	
NEW CL-SC	308		RE-TE	315	
NEW CL-TT	309		AUE NI + ARVUL	315	
NEW CL-EX	309		ARS-P	316	
NEW CL-PG	309		ARS-S	316	
NEW BBI-SDS	309		CS-B	316	
NEW BOCA-L	309		NEW MS-IS	316	
TPA-R	310		KC-PSA	317	
TPA-P	310		KC-PSD	317	
TRP-XS	310		KC-PSC	317	
NEW BOCA-L	310		KC-GPX	317	
NEW BOCA-L	310		KC-GPD	318	
NU-XS	311		KT-PSE	318	
KFS-MA	311		NEW KT-PSC	318	
KFS-AU	311		KT-GPX	318	
KFS-RV	311		Sistemas de fijación rápida en viga		
GS-TC	312		SU-CL	320	
GS-TU	312		SU-CL	320	
NEW GS-TP	312		SU-VA	320	
NEW GS-PI	312		SU-CU	321	
STR	312		SU-AB	321	
PMO	313		SU-CA	321	
PMO-D	313				
PMO-K	313				
PMO-L	313				

















ÍNDICE

Varilla roscada y accesorios de fijación

RV-ZN	324	
RV-ZN 8.8	324	
RV-A2	324	
RV-2M	325	
VR-SE	325	
MA-HE	325	
MA-HE	325	
MA-RI	326	
MA-MH	326	
AR-FO	326	
GA-FO	326	
AB-TA	327	
AB-TA B	327	
AB-TA A2	327	
AB-TR	327	
AB-PM7	328	
AB-TG	328	
TM-VR	328	
ES-DR	329	
ES-DA2	329	
AB-FP	329	
AB-FC	329	
PF-ZN	330	
PF-A4	330	
ABE-RM	330	
ABE-BO	330	

Fijación para sanitarios y climatización

RA-TRG	332	
RA-TRI	332	
RA-FRE	332	
RA-FIN	332	

RA-RO	333	
RA-FEM	333	
RA-RAY	333	
RA-PES	333	
SA-LN	334	
SA-LH	334	
SA-IL	334	
SA-WZ	334	
SA-WL	334	
SA-CI	335	
SA-WH	335	
SA-WHM	335	
SA-TE TB	335	
SA-TE AL	335	
CO-SO	336	
CO-KS	336	
EasyKits	337	



Gama Inox

MTP-A4		344				EV-M A4	352	
MTH-A2		344				GR-A4	352	
MTH-A4		345				GD-A4	352	
TXE		345				GI-A4	352	
NEW TXA		345				DIN-7504-K A2	353	
NEW TXP		346				ABE BIMETAL	353	
NEW TXT		346				ABE BIMETAL + ARVUL	353	
CH-A2		346				NEW ABE A4 BIMETAL	353	
CH-PI		347				AUTO BIMETAL	354	
CH-GF A2		347				AUTO BIMETAL + ARVUL	354	
CH-AF A2		347				PS 3 + ARVUL A2	354	
HE-A4		347				PS 5 + ARVUL A2	354	
HE-C4		347				NEW PST 3 + ARVUL A2	354	
AC-CI		348				NEW PST 5 + ARVUL A2	354	
HI-CI		348				ARVUL A2	355	
AVR		348				ARPAR A2	355	
AVC		348				DIN-7504-N HP A2	355	
EQ-A2		349				RS-A2	355	
EQ-A4		349				BCP A2	356	
T-NUX A A4		349				CP-A2	356	
T-NUX E A4		349				TEX-A2	356	
TC-A2		349				TP-A2	356	
RE-IN		350				DIN-571 A2	357	
SJ-A4		350				INV A2	357	
SJ-PS A4		350				DIN-933 A2	358	
SJ-PD A4		350				DIN-6921 A2	359	
TS-GA A4		350				DIN-603 A2	359	
TS-AA A4		351				DIN-934 A2	359	
TS-GG A4		351				DIN-985 A2	360	
EV-H A4		351				DIN-6923 A2	360	
						DIN-125 A2	360	





















































ÍNDICE

DIN-9021 A2	361		TU-RX A2	368	
DIN-127 A2	361		KFS-MA	368	
NEW PU-PMI	361		KFS-AU	368	
AB-RE A2	362		KFS-RV	368	
AB-RE A4	362		GS-TC	368	
AB-RI A2	362		GS-TU	369	
AB-RI A4	363		NEW GS-TP	369	
AB-ZI A2	363		NEW GS-PI	369	
AB-M6 A2	363		STR	369	
AB-SF A2	364		PMO	369	
AB-SF IR	364		NEW PMO-D	370	
AB-SF IRC	364		NEW PMO-K	370	
AB-SF IRR	364		NEW PMO-LK	370	
CI-PE A2	365		NEW PST 3 + ARVUL A2	370	
AB-ITS	365		NEW PST 5 + ARVUL A2	371	
AB-ITD	365		TAC BIMETAL + ARVUL A2	371	
GP-A2	365		ARS-P	371	
EG-A2	366		KT-PSE	371	
PG-A2	366		NEW KT-PSC	372	
KFR-SC	366		RV-A2	372	
NEW KFR-SCN	366		MA-RI	372	
NEW KFR-SS	366		AB-TA A2	372	
NEW EMP-XSD	366		ES-DA2	373	
NEW PSA-UNT	366		PF-A4	373	
NEW PSE-UNT	366		SA-IL	373	
NEW PSE-CUNT	367		SA-CI	373	
DIN-6921 A2	367				
DIN-603 A2	367				
DIN-6923 A2	367				
DIN-127 A2	368				
KFS-FI	368				

MATERIALES Y RECUBRIMIENTOS DE PRODUCTO

 Inoxidable A2	 Inoxidable A4	 Inoxidable AISI 430	 Bimetal	 Atlantis C4-M
 Atlantis C3-H	 Atlantis C3-M	 Atlantis C3-L	 Atlantis C2-H	 Atlantis C2-M
 Atlantis C2-L	 Bicromatado	 Cincado	 Cincado negro	 Cincado blanco
 Fosfatado	 Galvanizado azul	 Zamak	 Latón	 Cobre
 Pavonado	 Aluminio	 Polietileno	 Nylon	 PVC
 Plastificado negro	 Plastificado blanco	 Plastificado amarillo	 Polipropileno	 Butileno
 EPDM				

MATERIALES DE USO

 Carpintería aluminio	 Carpintería PVC	 Canalón	 Viga IPN	 Tubo ventilación
 Cartón yeso	 Cable	 Cadena	 Cuerda	 Tubo cromado
 Chapa - perfil pesado	 Ensamblaje Chapa	 Chapa - madera	 Fibrocemento	 Tubo butano
 Madera - metal	 Escayola	 Hormigón armado	 Hormigón fisurado	 Tubo fundición
 Hormigón	 Hormigón hueco	 Ladrillo macizo	 Tubo cobre	 Tubo gas
 Termoarcilla	 Piedra	 Ladrillo de adobe	 Tubo pvc	 Cable
 Madera noble	 Madera pino	 Hormigón celular	 Tubo plástico	 Tubo PPR
 Madera fina	 Panel de madera	 Ladrillo hueco	 Tubo inoxidable	 Tubo acero
 Placa alveolar	 Teja	 Instalación perfiles de aluminio	 Tubo incendios	 Tubo flexible
 SATE alta densidad	 SATE baja densidad	 Cerámico	 Azulejo	 Porcelanato
 Aluminio	 Vidrio	 Bloque de ladrillo		

HUELLAS







 Hexagonal	 Cuadrada	 Hexagonal con ranura	 Hexagonal con arandela estampada	 PH
 Ranura	 Allen	 TX	 PZ	

CARGAS









 Cargas ligeras	 Cargas medias	 Cargas altas	 Cargas muy altas
---	---	--	--

PROTECCIÓN FRENTE A LA CORROSIÓN

CATEGORÍAS DE CORROSIÓN

CATEGORÍAS DE CORROSIÓN	NIVEL DE CORROSIÓN	AMBIENTES TÍPICOS: EJEMPLOS DE ISO9223		RECUBRIMIENTOS DISPONIBLES INDEX®
		INTERIOR	EXTERIOR	
C1	MUY BAJO	Espacios calefactados con baja humedad relativa y contaminación insignificante, por ejemplo, oficinas, escuelas, museos.	Zona seca o fría, ambiente atmosférico con muy baja contaminación y tiempo de humedad, por ejemplo, ciertos desiertos, ártico central/antártico.	    
C2	BAJO	Espacios sin calefacción con temperatura variable y humedad relativa. Baja frecuencia de condensación y baja contaminación, por ejemplo, almacenamiento, pabellones deportivos.	Zona templada, ambiente atmosférico con baja contaminación (SO ₂ : <5 g/m ³), por ejemplo, zonas rurales, pequeñas ciudades. Zona seca o fría, ambiente atmosférico con poco tiempo de humedad, por ejemplo desiertos, zonas subárticas.	    
C3	MEDIO	Espacios con frecuencia moderada de condensación y contaminación moderada por el proceso de producción, por ejemplo, plantas de procesamiento de alimentos, lavanderías, cervecerías, lecherías.	Zona templada, ambiente atmosférico con contaminación media (SO ₂ : 5µ g/m ³ a 30µ g/m ³) o algún efecto de cloruros, por ejemplo, zonas urbanas, zonas costeras con baja deposición de cloruros. Zona tropical y subtropical, atmósfera con baja contaminación.	   
C4	ALTO	Espacios con alta frecuencia de condensación y alta contaminación por proceso de producción, por ejemplo, plantas de procesamiento industrial.	Zona templada, ambiente atmosférico con alta contaminación (SO ₂ : 30 g/m ³ a 90 g/m ³) o efecto sustancial de cloruros, por ejemplo, zonas urbanas contaminadas, zonas industriales, zonas costeras sin pulverización de agua salada (1-10 km) o, exposición a fuertes efectos de salinidad. Zona subtropical y tropical, atmósfera con contaminación media.	 
C5	MUY ALTO	Espacios con muy alta frecuencia de condensación y/o con alta contaminación por proceso de producción, por ejemplo, minas, cavernas con fines industriales, espacios sin ventilación en zonas subtropicales y tropicales.	Zona templada y subtropical, ambiente atmosférico con contaminación muy alta (SO ₂ : 90 g/m ³ a 250 g/m ³) y/o efecto significativo de cloruros, por ejemplo, zonas industriales, zonas costeras (0-1 km), instalaciones protegidas en la costa.	

GUÍA RÁPIDA DE SELECCIÓN

		CATEGORÍAS DE CORROSIÓN				
		C1	C2	C3	C4	C5
CONDICIONES MEDIOAMBIENTALES Y/O ATMOSFÉRICAS	 INTERIORES SIN CONDENSACIÓN	✓				
	 INTERIORES CON CONDENSACIÓN TEMPORAL		✓			
	 EXTERIORES EN ZONAS RURALES CON MUY BAJA CONTAMINACIÓN		✓			
	 EXTERIORES CON BAJA CONTAMINACIÓN			✓		
	 EXTERIORES CON CONCENTRACIÓN MODERADA DE CONTAMINACIÓN				✓	
	 ÁREAS COSTERAS					✓
	 EXTERIORES CON FUERTE CONTAMINACIÓN INDUSTRIAL					✓
	 ZONAS CERCANAS A CARRETERAS					✓

* La selección indicada en la tabla es para exposiciones esperadas de 25 años y siempre que cumplan con un mantenimiento adecuado.

* En el caso de instalaciones con productos homologados, el uso en esos ambientes no está cubierto por la Aprobación Técnica Europea (ETA) de anclajes, donde se establece que solo los anclajes de acero inoxidable se pueden instalar en exteriores y garantizando una vida útil del anclaje de 50 años.



FIJACIONES METÁLICAS

Los anclajes macho son una solución profesional y efectiva para la instalación de elementos con garantías de alto rendimiento en hormigón fisurado y no fisurado.

Disponibles en una amplia gama que incluye, entre otros, anclajes con homologación europea ETA 12/0397 para uso en hormigón fisurado y no fisurado, así como homologación sísmica C1&C2 y para resistencia a fuego, y homologación europea ETA 05/0242 para uso en hormigón no fisurado. Aptos para su instalación en aplicaciones interiores como exteriores gracias a las opciones de recubrimientos (ATLANTIS C3-L y cincado) y materiales disponibles (inoxidable A2, inoxidable A4 y acero).



DISEÑO Y GEOMETRÍA



Rebaje del eje como protección de la rosca durante la instalación del anclaje.



Tuerca. La rosca interna permite acoplar el tornillo, facilitando la sujeción y la unión de elementos desmontables. Se suministra premontada.



Arandela. Asegura una óptima presión del elemento a instalar. Se suministra con arandela DIN 125 premontada. Opcionalmente se puede suministrar con arandelas DIN 9021 (serie ancha) o DIN 440 (para madera).



La letra del eje indica la longitud el mismo, permitiendo conocer la longitud del anclaje una vez instalado. Es importante comprobar el espesor a fijar para elegir adecuadamente la longitud del anclaje necesaria.



Marca de profundidad de instalación. La línea pintada en el eje, establece la profundidad recomendada por la homologación para introducir el anclaje en el taladro.



Borde del eje. Permite que el clip se mantenga en su posición durante la instalación.



Clip de expansión y cono. El cono se retrae, expandiendo el clip, ejerciendo presión sobre el material base que, permite la fijación.



Identificación. Modelo y medida del mismo indicado en la clip.

APLICACIONES



- Aplicaciones estructurales
- Vigas y pilares estructurales
- Asientos en estadios
- Estructuras de madera a hormigón
- Barandillas y vallados
- Estanterías y racks
- Vigas y pilares estructurales
- Fijación de elementos no estructurales como carteles, maquinaria, calderas, señales, vallas publicitarias, etc.
- Otras instalaciones

CUALIDADES Y VENTAJAS



MÁXIMA VERSATILIDAD. PROFUNDIDAD DE ANCLAJE VARIABLE.

Permite la instalación hasta dos profundidades de atornillado distintas en M8, M10, M12, M16* y M20*

* En la versión MTH zincado

MÁXIMAS GARANTÍAS. PRODUCTOS HOMOLOGADOS ACORDE A LOS MÁS ALTOS ESTÁNDARES DE CALIDAD.

- Homologación ETA 12/0397 en opción 1 para la instalación en hormigón fisurado y no fisurado (C20/25-C50/60).
- Homologación ETA 05/0242 en opción 7 para la instalación en no fisurado (C20/25-C50/60).
- Homologación sísmica C1&C2.
- Homologado a resistencia a fuego R30-R120 en hormigón.
- Confirmada idoneidad para la instalación de sistemas de rociadores según la norma Vds CEA 4001.



GAMA



PRODUCTO	MTP	MTP-A4	MTP-X	MTP-AT	MTP-G	MTH	MTH-AT	MTH-A4	MTH-A2	MTA
EJE	Zincado	A4 Inox	Zincado	A4 Inox	A4 Inox	Zincado	A4 Inox	A4 Inox	A2 Inox	Zincado
CLIP	A4 Inox	A4 Inox	A4 Inox	A4 Inox	A4 Inox	Zincado	A4 Inox	A4 Inox	A2 Inox	Zincado
ETA 12/0397	✓	✓	✓	✓	✓		✓			
ETA 05/0242						✓		✓	✓	
R30-R120	✓	✓	✓	✓	✓					
Fire	✓	✓	✓	✓	✓	✓		✓	✓	
CEA 4001	✓	✓	✓	✓	✓					

EL RECUBRIMIENTO PERFECTO SEGÚN EL NIVEL DE CORROSIÓN



Recubrimiento Atlantis C3-L: válido para condiciones interiores secas (50 años) o en ambientes exteriores tipo C3 según la norma ISO 9223, por un periodo de 25 años.



Recubrimiento Zincado: apto para uso en condiciones interiores secas (categoría C1 según la norma ISO 9223), por un periodo de 50 años.



Material Inoxidable A4: válido para interior y exterior, en zonas costeras o industriales, zonas expuestas a alta contaminación o zonas cercanas a carreteras.



Material Inoxidable A2: válido para espacios interiores con alta frecuencia de condensación o ambientes exteriores que no estén situados próximas a zonas costeras o de elevada contaminación.

Anclaje macho para cargas altas en hormigón fisurado y no fisurado

MTP

02 Info Técnica
P. 377

MACIZOS



CÓDIGO	HOMOLOGACIÓN SÍSMICA	MEDIDA	€/100	ESPESOR MÁX. A FIJAR (MM)	LETRA EJE (LONGITUD)		
• AP08050	-	M8 x 50 Ø8	78,533	2	A	100	800
AP08075	-	M8 x 75 Ø8	83,180	9	C	100	600
AP08095	-	M8 x 95 Ø8	87,717	29	E	100	600
AP08115	-	M8 x 115 Ø8	107,627	49	G	100	400
AP10090	C1	M10 x 90 Ø10	113,737	10	E	100	400
AP10105	C1	M10 x 105 Ø10	134,973	25	F	50	300
AP10115	C1	M10 x 115 Ø10	142,823	35	G	50	200
AP10135	C1	M10 x 135 Ø10	164,140	55	H	50	200
AP10165	C1	M10 x 165 Ø10	197,513	85	K	50	200
AP10185	C1	M10 x 185 Ø10	209,240	105	L	50	150
• AP12080	-	M12 x 80 Ø12	162,687	4	D	50	300
AP12100	C1 & C2	M12 x 100 Ø12	178,457	4	E	50	200
AP12110	C1 & C2	M12 x 110 Ø12	174,193	14	F	50	200
AP12120	C1 & C2	M12 x 120 Ø12	212,740	24	G	50	200
AP12130	C1 & C2	M12 x 130 Ø12	220,217	34	H	50	200
AP12150	C1 & C2	M12 x 150 Ø12	260,017	54	I	50	100
AP12180	C1 & C2	M12 x 180 Ø12	310,160	84	L	50	150
AP12200	C1 & C2	M12 x 200 Ø12	362,880	104	M	50	150
AP16145	C1 & C2	M16 x 145 Ø16	402,807	28	I	25	100
AP16175	C1 & C2	M16 x 175 Ø16	520,167	58	K	25	50
AP16220	C1 & C2	M16 x 220 Ø16	610,700	103	O	25	50
AP16250	C1 & C2	M16 x 250 Ø16	791,973	133	Q	25	50
AP20170	-	M20 x 170 Ø20	785,987	32	K	20	40
AP20200	-	M20 x 200 Ø20	934,603	62	N	20	40
AP24205	-	M24 x 205 Ø24	1.808,703	35	N	10	30
AP24235	-	M24 x 235 Ø24	2.001,500	65	P	10	20

• Medidas sin homologar
• Medida sin homologar para fuego

Homologado ETE Opt.1. Eje zincado. Clip inoxidable A4



Disponibles con arandela DIN 9021. Consultar precio y plazo



Útil de colocación

02 Info Técnica
P. 377

INOXIDABLE



CÓDIGO	HOMOLOGACIÓN SÍSMICA	MEDIDA	€/100	ESPESOR MÁX. A FIJAR (MM)	LETRA EJE (LONGITUD)		
APA408075	-	M8 x 75 Ø8	317,357	9	C	100	600
APA408095	-	M8 x 95 Ø8	393,693	29	E	100	600
APA408115	-	M8 x 115 Ø8	445,823	49	G	100	400
APA408135	-	M8 x 135 Ø8	515,787	69	H	50	300
APA410090	C1 & C2	M10 x 90 Ø10	529,970	10	E	100	400
APA410105	C1 & C2	M10 x 105 Ø10	566,727	25	F	50	300
APA410115	C1 & C2	M10 x 115 Ø10	624,313	35	G	50	300
APA410135	C1 & C2	M10 x 135 Ø10	748,930	55	H	50	300
APA410165	C1 & C2	M10 x 165 Ø10	893,657	85	K	50	100
APA410185	C1 & C2	M10 x 185 Ø10	956,417	105	L	50	100
APA412110	C1 & C2	M12 x 110 Ø12	769,477	14	F	50	200
APA412120	C1 & C2	M12 x 120 Ø12	825,520	24	G	50	200
APA412130	C1 & C2	M12 x 130 Ø12	896,413	34	H	50	200
APA412150	C1 & C2	M12 x 150 Ø12	1.047,557	54	I	50	100
APA412180	C1 & C2	M12 x 180 Ø12	1.221,933	84	L	50	150
APA412200	C1 & C2	M12 x 200 Ø12	1.247,603	104	M	50	100
APA416125	C1 & C2	M16 x 125 Ø16	1.704,563	8	G	50	100
APA416145	C1 & C2	M16 x 145 Ø16	1.967,780	28	I	25	100
APA416175	C1 & C2	M16 x 175 Ø16	2.577,187	58	K	25	50
APA416190	C1 & C2	M16 x 190 Ø16	2.668,900	73	L	25	50
APA416220	C1 & C2	M16 x 220 Ø16	2.842,630	103	O	20	40
APA420200	C1 & C2	M20 x 200 Ø20	4.386,093	62	M	20	40
APA420240	C1 & C2	M20 x 240 Ø20	5.034,167	102	P	15	30
APA420285	C1 & C2	M20 x 285 Ø20	5.922,157	147	S	10	20

Homologado ETE Opt.1. Eje Inoxidable A4. Clip inoxidable A4



Útil de colocación

MTP

Anclaje macho para cargas altas en hormigón fisurado y no fisurado

MTP-AT

Homologado ETE Opt.1. Eje ATLANTIS C4-M. Clip inoxidable



Útil de colocación

02 Info. Técnica P. 378

MACIZOS

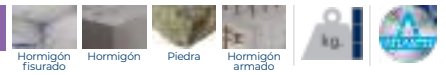

CÓDIGO	HOMOLOGACIÓN SÍSMICA	MEDIDA	€/100	ESPESOR MÁX. A FIJAR (MM)	LETRA EJE (LONGITUD)		
APAT08075	-	M8 x 75 Ø8	124,770	9	C	100	600
APAT08095	-	M8 x 95 Ø8	131,580	29	E	100	600
APAT08115	-	M8 x 115 Ø8	161,447	49	G	100	400
APAT10090	C1	M10 x 90 Ø10	176,287	10	E	100	400
APAT10105	C1	M10 x 105 Ø10	209,213	25	F	50	300
APAT10115	C1	M10 x 115 Ø10	221,377	35	G	50	200
APAT10135	C1	M10 x 135 Ø10	262,623	55	H	50	200
APAT10165	C1	M10 x 165 Ø10	306,147	85	K	50	200
APAT10185	C1	M10 x 185 Ø10	324,327	105	L	50	150
APAT12100	C1 & C2	M12 x 100 Ø12	260,300	4	E	50	200
APAT12110	C1 & C2	M12 x 110 Ø12	294,457	14	F	50	200
APAT12120	C1 & C2	M12 x 120 Ø12	296,130	24	G	50	200
APAT12130	C1 & C2	M12 x 130 Ø12	340,380	34	H	50	200
APAT12150	C1 & C2	M12 x 150 Ø12	390,023	54	I	50	100
APAT12180	C1 & C2	M12 x 180 Ø12	465,243	84	L	50	150
APAT12200	C1 & C2	M12 x 200 Ø12	544,320	104	M	50	150
APAT16145	C1 & C2	M16 x 145 Ø16	616,893	28	I	25	100
APAT16175	C1 & C2	M16 x 175 Ø16	644,490	58	K	25	50
APAT16220	C1 & C2	M16 x 220 Ø16	884,287	103	O	25	50
APAT20170	-	M20 x 170 Ø20	1.068,730	32	K	20	40
APAT20200	-	M20 x 200 Ø20	1.401,910	62	N	20	40

MTP-X

Homologado ETE Opt.1. Eje zincado. Clip ATLANTIS C3-L



Disponibles con arandela DIN 9021. Consultar precio y plazo

Útil de colocación

02 Info. Técnica P. 378

MACIZOS

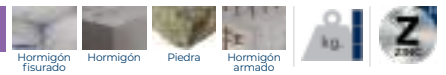

CÓDIGO	HOMOLOGACIÓN SÍSMICA	MEDIDA	€/100	ESPESOR MÁX. A FIJAR (MM)	LETRA EJE (LONGITUD)		
•• APX08050	-	M8 x 50 Ø8	67,273	2	A	100	800
APX08075	C1	M8 x 75 Ø8	71,233	9	C	100	600
APX08080	C1	M8 x 80 Ø8	73,367	14	D	100	600
APX08095	C1	M8 x 95 Ø8	77,203	29	E	100	600
APX08115	C1	M8 x 115 Ø8	94,753	49	G	100	400
APX10090	C1 & C2	M10 x 90 Ø10	100,117	10	E	100	400
APX10105	C1 & C2	M10 x 105 Ø10	113,437	25	F	50	300
APX10115	C1 & C2	M10 x 115 Ø10	119,013	35	G	50	200
APX10135	C1 & C2	M10 x 135 Ø10	148,273	55	H	50	200
APX10165	C1 & C2	M10 x 165 Ø10	173,110	85	K	50	200
APX10185	C1 & C2	M10 x 185 Ø10	191,160	105	L	50	150
•• APX12080	-	M12 x 80 Ø12	135,280	4	D	50	300
APX12100	C1 & C2	M12 x 100 Ø12	149,193	4	E	50	200
APX12110	C1 & C2	M12 x 110 Ø12	152,563	14	F	50	200
APX12120	C1 & C2	M12 x 120 Ø12	191,160	24	G	50	200
APX12130	C1 & C2	M12 x 130 Ø12	199,733	34	H	50	200
APX12150	C1 & C2	M12 x 150 Ø12	218,117	54	I	50	100
APX12180	C1 & C2	M12 x 180 Ø12	273,263	84	L	50	150
APX12200	C1 & C2	M12 x 200 Ø12	318,600	104	M	50	150
APX12220	C1 & C2	M12 x 220 Ø12	334,530	124	O	25	50
APX12255	C1 & C2	M12 x 255 Ø12	367,983	159	R	25	50
APX16145	C1	M16 x 145 Ø16	387,220	28	I	25	100
APX16175	C1	M16 x 175 Ø16	453,390	58	K	25	50
APX16220	C1	M16 x 220 Ø16	533,047	103	O	25	50
APX16250	C1	M16 x 250 Ø16	686,217	133	Q	25	50
APX20170	C1 & C2	M20 x 170 Ø20	692,343	32	K	20	40
APX20200	C1 & C2	M20 x 200 Ø20	790,370	62	M	20	40

• Medidas sin homologar
• Medida sin homologar para fuego

Anclaje macho para cargas altas en hormigón fisurado y no fisurado

MTP



MACIZOS

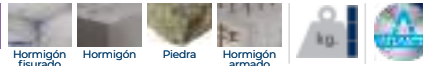

MTP-G

Homologado ETE Opt.1. Eje ATLANTIS C3-L. Clip inoxidable A4

CÓDIGO	HOMOLOGACIÓN SÍSMICA	MEDIDA	€/100	ESPESOR MÁX. A FIJAR (MM)	LETRA EJE (LONGITUD)		
• APG06060	-	M6 x 60 Ø6	61,603	10	B	200	1.200
• APG06070	-	M6 x 70 Ø6	63,497	20	C	200	1.200
• APG06100	-	M6 x 100 Ø6	69,650	50	E	200	800
• APG08050	-	M8 x 50 Ø8	81,383	2	A	100	800
• APG08060	-	M8 x 60 Ø8	82,120	12	B	100	800
APG08075	C1	M8 x 75 Ø8	95,640	9	C	100	600
APG08095	C1	M8 x 95 Ø8	103,383	29	E	100	600
APG08115	C1	M8 x 115 Ø8	119,547	49	G	100	400
• APG10070	-	M10 x 70 Ø10	125,033	5	C	100	400
APG10090	C1	M10 x 90 Ø10	144,037	10	E	100	400
APG10105	C1	M10 x 105 Ø10	155,650	25	F	50	300
APG10115	C1	M10 x 115 Ø10	163,620	35	G	50	200
APG10135	C1	M10 x 135 Ø10	179,933	55	H	50	200
APG10165	C1	M10 x 165 Ø10	221,110	85	K	50	200
APG10185	C1	M10 x 185 Ø10	239,083	105	L	50	150
• APG12080	-	M12 x 80 Ø12	217,197	4	D	50	300
APG12110	C1 & C2	M12 x 110 Ø12	250,093	14	F	50	200
APG12130	C1 & C2	M12 x 130 Ø12	296,593	34	H	50	200
APG12150	C1 & C2	M12 x 150 Ø12	317,150	54	I	50	100
APG12180	C1 & C2	M12 x 180 Ø12	349,280	84	L	50	150
APG12200	C1 & C2	M12 x 200 Ø12	352,313	104	M	50	150
APG16125	C1 & C2	M16 x 125 Ø16	484,267	8	G	25	100
APG16145	C1 & C2	M16 x 145 Ø16	512,160	28	I	25	100
APG16175	C1 & C2	M16 x 175 Ø16	563,187	58	K	25	50
APG16220	C1 & C2	M16 x 220 Ø16	700,297	103	O	25	50
APG20170	C1 & C2	M20 x 170 Ø20	870,987	32	K	20	40
APG20200	C1 & C2	M20 x 200 Ø20	879,347	62	M	20	40



Útil de colocación

- Medidas sin homologar
- Medida sin homologar para fuego



MÁS INFORMACIÓN DISPONIBLE
EN NUESTRA NUEVA PÁGINA WEB
WWW.INDEXFIX.COM

MTH

Anclaje macho para cargas altas en hormigón no fisurado

MTH

Homologado ETE Opt.7. Eje zincado.
Clip zincado

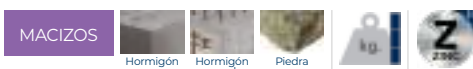

Disponible con arandela DIN 9021.
Consultar precio y plazo

Útil de colocación

CÓDIGO	MEDIDA	€/100	ESPESOR MÁX. A FIJAR (MM)	LETRA EJE (LONGITUD)		
AH06060	M6 x 60 Ø6	44,637	2	B	200	1.200
AH06070	M6 x 70 Ø6	46,340	12	C	200	1.200
AH06080	M6 x 80 Ø6	48,037	22	D	200	1.200
AH06090	M6 x 90 Ø6	49,503	32	E	200	1.200
AH06100	M6 x 100 Ø6	51,567	42	E	200	800
AH06110	M6 x 110 Ø6	64,507	52	F	200	800
AH06120	M6 x 120 Ø6	67,727	62	G	100	600
AH06130	M6 x 130 Ø6	72,270	72	H	100	600
AH06140	M6 x 140 Ø6	74,970	82	I	100	400
AH06150	M6 x 150 Ø6	82,757	92	I	100	400
AH06160	M6 x 160 Ø6	87,223	102	J	100	400
AH06170	M6 x 170 Ø6	98,900	112	K	100	400
AH06180	M6 x 180 Ø6	108,660	122	L	100	200
AH08060	M8 x 60 Ø8	52,520	3	B	100	600
AH08075	M8 x 75 Ø8	54,823	5	C	100	600
AH08090	M8 x 90 Ø8	59,431	20	E	100	600
AH08100	M8 x 100 Ø8	63,414	30	E	100	400
AH08115	M8 x 115 Ø8	77,560	45	G	100	400
AH08120	M8 x 120 Ø8	84,877	50	G	100	400
AH08130	M8 x 130 Ø8	93,272	60	H	100	400
AH08155	M8 x 155 Ø8	135,464	85	J	100	200
AH10070	M10 x 70 Ø10	71,450	3	C	100	400
AH10080	M10 x 80 Ø10	79,396	13	D	100	400
AH10090	M10 x 90 Ø10	82,781	10	E	100	400
AH10100	M10 x 100 Ø10	95,450	20	E	100	400
AH10120	M10 x 120 Ø10	100,150	40	G	50	300
AH10140	M10 x 140 Ø10	121,248	60	H	50	200
AH10150	M10 x 150 Ø10	127,346	70	I	50	200
AH10160	M10 x 160 Ø10	157,453	80	J	50	200
AH10170	M10 x 170 Ø10	172,206	90	K	50	200
AH10210	M10 x 210 Ø10	212,414	130	N	50	150
AH10230	M10 x 230 Ø10	225,310	150	P	50	100
AH12090	M12 x 90 Ø12	118,633	13	E	50	200
AH12100	M12 x 100 Ø12	128,223	8	E	50	200
AH12110	M12 x 110 Ø12	131,394	18	F	50	200
AH12120	M12 x 120 Ø12	155,938	28	G	50	200
AH12130	M12 x 130 Ø12	161,027	38	H	50	200
AH12140	M12 x 140 Ø12	161,394	48	H	50	200
AH12160	M12 x 160 Ø12	191,492	68	J	50	100
AH12180	M12 x 180 Ø12	229,897	88	L	50	150
AH12200	M12 x 200 Ø12	274,433	108	M	50	100
AH12220	M12 x 220 Ø12	291,367	128	O	50	100
AH12250	M12 x 250 Ø12	349,330	158	Q	25	50
AH14120	M14 x 120 Ø14	267,374	12	G	25	100
AH14145	M14 x 145 Ø14	320,007	37	I	25	100
AH14170	M14 x 170 Ø14	341,877	62	K	25	100
AH14220	M14 x 220 Ø14	465,098	112	O	25	75
AH14250	M14 x 250 Ø14	519,511	142	Q	25	50
AH16125	M16 x 125 Ø16	277,008	3	G	25	100
AH16145	M16 x 145 Ø16	298,501	23	I	25	100
AH16170	M16 x 170 Ø16	369,138	48	K	25	50
AH16220	M16 x 220 Ø16	444,146	98	O	25	50
AH16250	M16 x 250 Ø16	575,949	128	Q	25	50
AH16280	M16 x 280 Ø16	639,027	158	S	25	50
AH20170	M20 x 170 Ø20	545,148	23	K	20	40
AH20220	M20 x 220 Ø20	678,784	73	O	20	40
AH20270	M20 x 270 Ø20	927,666	123	S	20	40

• Medida sin homologar para fuego

Anclaje macho para cargas altas en hormigón no fisurado

MTH

02 Info
P. 380 Técnica

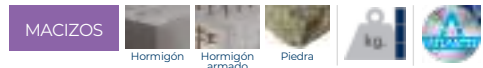

MTH-AT

Homologado ETE Opt.7. Eje ATLANTIS C4-M. Clip ATLANTIS C4-M

CÓDIGO	MEDIDA	€/100	ESPESOR MÁX. A FIJAR (MM)	LETRA EJE (LONGITUD)		
AHAT06060	M6 x 60 Ø6	70,037	2	B	200	1.200
AHAT06080	M6 x 80 Ø6	75,363	22	D	200	1.200
AHAT06100	M6 x 100 Ø6	83,280	42	E	200	800
AHAT08060	M8 x 60 Ø8	89,237	3	B	100	600
AHAT08075	M8 x 75 Ø8	97,983	5	C	100	600
AHAT08090	M8 x 90 Ø8	109,167	20	E	100	600
AHAT08115	M8 x 115 Ø8	135,367	45	G	100	400
AHAT08130	M8 x 130 Ø8	144,707	60	H	100	400
AHAT08155	M8 x 155 Ø8	213,230	85	J	100	200
AHAT10070	M10 x 70 Ø10	141,557	3	C	100	400
AHAT10080	M10 x 80 Ø10	169,580	13	D	100	400
AHAT10090	M10 x 90 Ø10	176,813	10	E	100	400
AHAT10100	M10 x 100 Ø10	194,607	20	E	100	400
AHAT10120	M10 x 120 Ø10	218,777	40	G	50	300
AHAT10140	M10 x 140 Ø10	252,827	60	H	50	200
AHAT10150	M10 x 150 Ø10	265,540	70	I	50	200
AHAT10160	M10 x 160 Ø10	285,240	80	J	50	200
AHAT10170	M10 x 170 Ø10	304,170	90	K	50	200
AHAT10210	M10 x 210 Ø10	365,567	130	N	50	150
AHAT12090	M12 x 90 Ø12	254,210	13	E	50	200
AHAT12100	M12 x 100 Ø12	274,763	8	E	50	200
AHAT12110	M12 x 110 Ø12	284,267	18	F	50	200
AHAT12130	M12 x 130 Ø12	348,377	38	H	50	200
AHAT12140	M12 x 140 Ø12	333,303	48	H	50	200
AHAT12160	M12 x 160 Ø12	395,457	68	J	50	100
AHAT12180	M12 x 180 Ø12	455,450	88	L	50	150
AHAT12200	M12 x 200 Ø12	531,870	108	M	50	100
AHAT12220	M12 x 220 Ø12	563,487	128	O	50	100
AHAT12250	M12 x 250 Ø12	626,157	158	Q	25	50
AHAT16125	M16 x 125 Ø16	564,777	3	G	25	100
AHAT16145	M16 x 145 Ø16	637,577	23	I	25	100
AHAT16170	M16 x 170 Ø16	770,530	48	K	25	50
AHAT16220	M16 x 220 Ø16	960,890	98	O	25	50
AHAT16250	M16 x 250 Ø16	1.079,903	128	Q	25	50
AHAT16280	M16 x 280 Ø16	1.175,567	158	S	25	50
AHAT20170	M20 x 170 Ø20	1.190,857	23	K	20	40
AHAT20220	M20 x 220 Ø20	1.515,730	73	O	20	40
AHAT20270	M20 x 270 Ø20	1.756,257	123	S	20	40



Útil de colocación

MTH

Anclaje macho para cargas altas en hormigón no fisurado

MTH-A2

Homologado ETE Opt.7. Eje inoxidable A2. Clip inoxidable A2

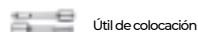

02 Info. Técnica
P. 381

INOXIDABLE

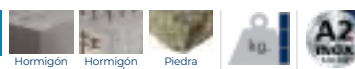

CÓDIGO	MEDIDA	€/100	ESPESOR MÁX. A FIJAR (MM)	LETRA EJE (LONGITUD)		
• MIO6045	M6 x 45 Ø6	118,327	1	A	200	1.200
• MIO6060	M6 x 60 Ø6	132,697	2	B	200	1.200
• MIO6080	M6 x 80 Ø6	138,793	22	D	200	1.200
• MIO6120	M6 x 120 Ø6	175,317	62	G	100	600
• MIO6140	M6 x 140 Ø6	216,960	82	I	100	600
• MIO6160	M6 x 160 Ø6	235,343	102	J	100	400
• MIO6170	M6 x 170 Ø6	253,434	112	K	100	400
• MIO6180	M6 x 180 Ø6	293,136	122	L	100	300
• MIO8050	M8 x 50 Ø8	140,943	4	A	100	800
MIO8075	M8 x 75 Ø8	154,380	5	C	100	600
MIO8090	M8 x 90 Ø8	175,687	20	E	100	600
MIO8115	M8 x 115 Ø8	227,260	45	G	100	400
MI10070	M10 x 70 Ø10	238,873	3	C	100	400
MI10090	M10 x 90 Ø10	267,387	10	E	100	400
MI10120	M10 x 120 Ø10	320,529	40	G	50	300
MI10150	M10 x 150 Ø10	446,763	70	I	50	200
• MI12075	M12 x 75 Ø12	362,203	5	C	50	300
MI12090	M12 x 90 Ø12	384,384	13	D	50	200
MI12110	M12 x 110 Ø12	423,588	18	F	50	200
MI12140	M12 x 140 Ø12	530,916	48	I	50	200
• MI16090	M16 x 90 Ø16	1.000,270	4	D	25	150
MI16145	M16 x 145 Ø16	1.392,707	23	I	25	100
MI16170	M16 x 170 Ø16	1.576,917	48	K	25	75
• MI20120	M20 x 120 Ø20	1.807,833	5	G	20	40
MI20170	M20 x 170 Ø20	2.444,500	23	K	20	40
MI20220	M20 x 220 Ø20	3.062,987	73	O	20	40

• Medidas sin homologar
• Medida sin homologar para fuego

Caja ventana

CÓDIGO	MEDIDA	€/CAJA	PCS	CAJAS
VMI08075	M8 x 75 Ø8	22,100	10	8
VMI08090	M8 x 90 Ø8	23,629	10	8
VMI10070	M10 x 70 Ø10	24,417	8	8
VMI10090	M10 x 90 Ø10	27,331	8	8
VMI10120	M10 x 120 Ø10	24,026	6	8
VMI12110	M12 x 110 Ø12	29,808	6	8

MTH-A4

Homologado ETE Opt.7. Eje inoxidable A4. Clip inoxidable A4



Disponible con arandela DIN 9021. Consultar precio y plazo

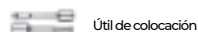

02 Info. Técnica
P. 380

INOXIDABLE

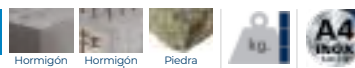

CÓDIGO	MEDIDA	€/100	ESPESOR MÁX. A FIJAR (MM)	LETRA EJE (LONGITUD)		
• MIA406045	M6 x 45 Ø6	146,353	1	A	200	1.200
• MIA406060	M6 x 60 Ø6	159,443	2	B	200	1.200
• MIA406080	M6 x 80 Ø6	178,310	22	D	200	1.200
• MIA408050	M8 x 50 Ø8	187,323	4	A	100	800
MIA408075	M8 x 75 Ø8	207,767	5	C	100	600
MIA408090	M8 x 90 Ø8	226,910	20	E	100	600
MIA408115	M8 x 115 Ø8	285,133	45	G	100	400
MIA410070	M10 x 70 Ø10	325,793	3	C	100	400
MIA410090	M10 x 90 Ø10	369,267	10	E	100	400
MIA410120	M10 x 120 Ø10	448,880	40	G	50	300
MIA410150	M10 x 150 Ø10	657,360	70	I	50	200
• MIA412075	M12 x 75 Ø12	498,023	5	C	50	300
MIA412090	M12 x 90 Ø12	529,160	13	D	50	200
MIA412110	M12 x 110 Ø12	596,347	18	F	50	200
MIA412140	M12 x 140 Ø12	715,110	48	I	50	200
• MIA416090	M16 x 90 Ø16	1.321,547	4	D	25	150
MIA416145	M16 x 145 Ø16	1.736,247	23	I	25	100
MIA416170	M16 x 170 Ø16	2.004,967	48	K	25	75
• MIA420120	M20 x 120 Ø20	2.330,647	5	G	20	40
MIA420170	M20 x 170 Ø20	3.185,910	23	K	20	40
MIA420220	M20 x 220 Ø20	3.966,147	73	O	20	40

• Medidas sin homologar
• Medida sin homologar para fuego

Caja ventana

CÓDIGO	MEDIDA	€/CAJA	PCS	CAJAS
VMI408075	M8 x 75 Ø8	28,783	10	8
VMI410090	M10 x 90 Ø10	39,392	8	8
VMI412110	M12 x 110 Ø12	45,068	6	8

Anclaje macho para cargas altas

MTA

Info
Técnica
P. 381

MACIZOS

CÓDIGO	MEDIDA	€/100	ESPESOR MÁX. A FIJAR (MM)		
AM06045	M6 x 45 Ø6	34,902	1	200	1.200
AM06055	M6 x 55 Ø6	36,458	11	200	1.200
AM06060	M6 x 60 Ø6	36,122	2	200	1.200
AM06065	M6 x 65 Ø6	37,640	7	200	1.200
AM06070	M6 x 70 Ø6	38,613	12	200	1.200
AM06080	M6 x 80 Ø6	39,660	22	200	1.200
AM06085	M6 x 85 Ø6	41,350	27	200	1.200
AM06090	M6 x 90 Ø6	41,830	32	200	1.200
AM06100	M6 x 100 Ø6	44,937	42	200	800
AM06110	M6 x 110 Ø6	47,550	52	200	800
AM06120	M6 x 120 Ø6	49,080	62	100	600
AM06130	M6 x 130 Ø6	49,959	72	100	600
AM06140	M6 x 140 Ø6	63,773	82	100	600
AM06150	M6 x 150 Ø6	73,730	92	100	600
AM06160	M6 x 160 Ø6	77,560	102	100	400
AM06170	M6 x 170 Ø6	91,324	112	100	400
AM06180	M6 x 180 Ø6	99,587	122	100	300
AM08050	M8 x 50 Ø8	44,307	4	100	800
AM08060	M8 x 60 Ø8	43,659	3	100	800
AM08065	M8 x 65 Ø8	45,519	8	100	600
AM08075	M8 x 75 Ø8	45,938	5	100	600
AM08090	M8 x 90 Ø8	49,402	20	100	600
AM08115	M8 x 115 Ø8	62,512	45	100	400
AM08120	M8 x 120 Ø8	63,709	50	100	400
AM08130	M8 x 130 Ø8	73,304	60	100	400
AM08155	M8 x 155 Ø8	129,002	85	100	200
AM10065	M10 x 65 Ø10	71,117	1	100	400
AM10070	M10 x 70 Ø10	64,800	3	100	400
AM10080	M10 x 80 Ø10	67,657	13	100	400
AM10090	M10 x 90 Ø10	72,259	10	100	400
AM10100	M10 x 100 Ø10	79,730	20	100	400
AM10120	M10 x 120 Ø10	86,587	40	50	300
AM10140	M10 x 140 Ø10	98,273	60	50	200
AM10150	M10 x 150 Ø10	109,498	70	50	200
AM10160	M10 x 160 Ø10	137,186	80	50	200

CÓDIGO	MEDIDA	€/100	ESPESOR MÁX. A FIJAR (MM)		
AM10170	M10 x 170 Ø10	143,487	90	50	200
AM10210	M10 x 210 Ø10	198,811	130	50	150
AM10230	M10 x 230 Ø10	222,180	150	50	100
AM12075	M12 x 75 Ø12	103,269	5	50	300
AM12080	M12 x 80 Ø12	101,868	3	50	300
AM12090	M12 x 90 Ø12	106,943	13	50	200
AM12100	M12 x 100 Ø12	108,207	8	50	200
AM12110	M12 x 110 Ø12	111,417	18	50	200
AM12120	M12 x 120 Ø12	126,957	28	50	200
AM12140	M12 x 140 Ø12	140,449	48	50	200
AM12160	M12 x 160 Ø12	167,001	68	50	100
AM12180	M12 x 180 Ø12	199,279	88	50	150
AM12220	M12 x 220 Ø12	261,443	128	50	100
AM12250	M12 x 250 Ø12	317,562	158	25	50
AM14080	M14 x 80 Ø14	188,054	5	50	200
AM14100	M14 x 100 Ø14	208,771	5	50	100
AM14120	M14 x 120 Ø14	234,129	12	25	100
AM14145	M14 x 145 Ø14	285,217	37	25	100
AM14170	M14 x 170 Ø14	314,690	62	25	100
AM14220	M14 x 220 Ø14	419,582	112	25	75
AM14250	M14 x 250 Ø14	453,863	142	25	50
AM16090	M16 x 90 Ø16	228,391	4	25	150
AM16110	M16 x 110 Ø16	233,103	7	25	100
AM16125	M16 x 125 Ø16	236,013	3	25	100
AM16145	M16 x 145 Ø16	250,647	23	25	100
AM16170	M16 x 170 Ø16	310,447	48	25	50
AM16220	M16 x 220 Ø16	387,720	98	25	50
AM16250	M16 x 250 Ø16	513,125	128	25	50
AM16280	M16 x 280 Ø16	553,280	158	25	50
AM20120	M20 x 120 Ø20	410,153	5	20	40
AM20170	M20 x 170 Ø20	486,169	23	20	40
AM20220	M20 x 220 Ø20	611,840	73	20	40
AM20270	M20 x 270 Ø20	819,493	123	20	40
AM24180	M24 x 180 Ø24	1.435,687	10	10	20
AM24260	M24 x 260 Ø24	1.976,533	80	10	20



Disponibles con arandela DIN 9021.
Consultar precio y plazo



Útil de colocación

Blíster

CÓDIGO	MEDIDA	€/BOLSA	PCS BOLSA	BOLSAS
BZAM06060	M6 x 60 Ø6	3,377	2	20
BZAM06080	M6 x 80 Ø6	3,377	2	20
BZAM08050	M8 x 50 Ø8	3,377	2	15
BZAM08075	M8 x 75 Ø8	3,377	2	15
BZAM08090	M8 x 90 Ø8	3,377	2	15
BZAM10070	M10 x 70 Ø10	3,377	2	12
BZAM10090	M10 x 90 Ø10	3,377	2	12
BZAM10120	M10 x 120 Ø10	3,377	2	12
BZAM12090	M12 x 90 Ø12	3,377	2	10
BZAM12110	M12 x 110 Ø12	3,377	2	10
BZAM12140	M12 x 140 Ø12	3,377	2	10

Caja ventana

CÓDIGO	MEDIDA	€/CAJA	PCS CAJAS
VAM06060	M6 x 60 Ø6	8,734	20
VAM08075	M8 x 75 Ø8	7,307	12
VAM08090	M8 x 90 Ø8	7,768	12
VAM10070	M10 x 70 Ø10	4,899	6
VAM10090	M10 x 90 Ø10	5,431	6
VAM10120	M10 x 120 Ø10	6,454	6
VAM12090	M12 x 90 Ø12	7,919	6
VAM12110	M12 x 110 Ø12	8,276	6



INDEXcal V4

SOFTWARE DE CÁLCULO DE ANCLAJES

El programa de cálculo de anclajes INDEXcal es la herramienta adecuada para que los diseñadores de soluciones estructurales cumplan con los requisitos del Eurocódigo 2, parte 4. Comprueba de forma rápida y detallada todos los anclajes de nuestro catálogo en base a parámetros de entrada del usuario, indicando su adecuación o no a las mismas.

Prestaciones:

- Válido para hormigón fisurado y no fisurado de distintas resistencias.
 - Cálculo para condiciones de fuego y/o sísmico.
- Indica la razón de rechazo de aquellos anclajes que no cumplan los requisitos estructurales.
- Personalización de placas de anclajes, incluyendo rectangulares, circulares, hexagonales, octogonales e irregulares.
 - Permite incluir en el diseño perfiles normalizados o personalizados.
 - Opción filtrado anclajes.
- Multilingüe: disponible en castellano, inglés, francés, alemán y holandés.
- Acceso directo a fichas técnicas y homologaciones desde el propio software.
 - Informe completo en pdf, personalizable.
 - Actualizable on-line.
 - Interface usuario 3D.
- Disponible para un uso gratuito, pudiéndose descargar en la página web.
- Permite incluir cálculo con varias hipótesis de cargas de forma simultánea.

CALIDAD CERTIFICADA

Nuestra obsesión por la perfección lleva a ampliar continuamente nuestras certificaciones y homologaciones de laboratorios independientes y de los principales organismos oficiales que garantizan la máxima calidad tanto en productos como en sistemas de gestión.



Conformidad Europea



Evaluación Técnica Europea



Homologación Sísmica



Underwriters Laboratories



ICC-ES®



Resistencia al fuego



Emisiones VOC reducidas



Leadership in Energy and Environmental Design



Homologación FM



Accesorios para anclaje macho para cargas altas MT

MT-AC

MACIZOS



CÓDIGO	MEDIDA	€/PC		
DOMTA10	M6 - M8 - M10	10,302	5	225
DOMTA20	M12 - M14 - M16 - M20	17,171	5	225

DO-MT

Útil de colocación para Familia MT



METAL



CÓDIGO	MEDIDA	€/100		
TPMTBL06	M6	19,630	500	3.000
TPMTBL08	M8	23,167	250	3.000
TPMTBL10	M10	25,660	250	1.000
TPMTBL12	M12	36,850	250	1.000
TPMTBL16	M16	53,340	100	400

TP-MT BL

Blanco



METAL



CÓDIGO	MEDIDA	€/100		
TPMTNE06	M6	19,630	500	3.000
TPMTNE08	M8	23,167	250	3.000
TPMTNE10	M10	25,660	250	1.000
TPMTNE12	M12	36,850	250	1.000
TPMTNE16	M16	53,340	100	400

TP-MT NE

Negro



Anclaje macho de suspensión

TWA

MACIZOS



CÓDIGO	MEDIDA	€/100		
TWA06060	6 x 60 Ø6	31,023	100	2.400



TH | TX | TF

Los anclajes homologados de alto rendimiento de fijación directa en hormigón fisurado y no fisurado son la solución más profesional y efectiva. Su diseño permite una instalación rápida y sencilla garantizando las máximas prestaciones y unos mayores valores de cargas respecto a la versión anterior. El surtido de anclajes TH/TF consta de diferentes modelos de cabezas, aptos para la instalación en elementos estructurales y no estructurales como barandillas, estanterías o elementos que deban desinstalarse o ajustarse.



DISEÑO Y GEOMETRÍA



Rosca doble patentada, diseñada para incrustarse profundamente en el hormigón y garantizar las máximas cargas.



Cabeza THE/TFE: **Arandela estriada estampada en versiones hexagonales**, que asegura un apriete contra el material base, impidiendo que la fijación se afloje.



Cabeza: **Medida estampada en la cabeza** (excepto en Ø5). Permite identificar qué medida se ha instalado.



La **punta templada** garantiza una mayor dureza, durabilidad y facilidad durante la instalación.



Cuerpo de acero al carbono estampado de alta resistencia.

CUALIDADES Y VENTAJAS

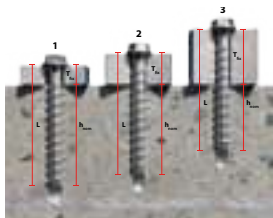

+ VERSATILIDAD

Permite la **instalación con hasta tres profundidades** de atornillado distintas (en versión Ø10).

Adicionalmente **permite desatornillarse** para nivelar o hacer un correcto ajuste del elemento instalado.



+ PRODUCTIVIDAD

- Genera bajas cargas sobre el hormigón, permitiendo **usar métricas más pequeñas** y, por consiguiente, hacer instalaciones con reducidas distancias entre anclajes y al borde del elemento de hormigón.
- **No necesita par de apriete**. Permite asegurarnos de que siempre está perfectamente instalado.
- **Instalación EXPRES**. Únicamente requiere un taladro y una máquina de impacto.

NEWNEWNEW MODELO TX BIMETAL



Fabricado con la innovadora tecnología BIMETAL, ofrece una alta resistencia tanto a la corrosión como al desgaste durante la instalación. Por un lado, el cuerpo del anclaje está fabricado con acero inoxidable A4, dotándole de prestaciones anticorrosivas, hasta niveles de corrosión C5. La punta del anclaje, en cambio, está fabricada en acero al carbono endurecido, de mayor dureza y que facilita la instalación y el agarre en el material base. El innovador proceso productivo, permite la soldadura por fricción de los dos materiales.

MÁXIMAS GARANTÍAS

- Homologado (ETA 20/0046) en opción 1 para la instalación en hormigón fisurado y no fisurado (C20/25-C50/60).
- Homologado (ETA 20/0494) para sistemas redundantes no estructurales en hormigón (C20/25) y losas alveolares (≥ C30/37).
- Homologado a resistencia a fuego R30-R120 en hormigón.
- Homologación Sísmica C1&C2.
- Confirmada idoneidad para la instalación de sistemas de rociadores según la norma Vds CEA 4001.



APLICACIONES



Aplicaciones para versión homologada ETA 20/0046 (instalaciones en hormigón fisurado y no fisurado):

- Aplicaciones estructurales.
- Toldos o señalizaciones provisionales.
- Asientos en estadios.
- Estructuras de madera a hormigón.
- Barandillas y vallados.
- Estanterías y racks.
- Vigas y pilares estructurales.



Aplicaciones para versión homologada ETA 20/0494 (instalaciones no estructurales):

- Fijación de tuberías.
- Conductos de aire acondicionado.
- Bandejas eléctricas o sistemas de cableado.
- Instalaciones en techos de hormigón hueco.
- Instalaciones en techos de losas alveolares.

FABRICACIÓN 100% INDEX

Esto nos permite asegurar un riguroso control de los procesos, garantizar la máxima calidad en nuestros productos, brindar el mejor servicio y obtener un coste global competitivo.

GAMA



PRODUCTO	THE	THA	THP	THT	TXE	TXA	TXP	TXT	TFE	TFA	TFN	TFS	TFP	TFT	TFM	TFH	TFY
TIPO DE CABEZA	Hexagonal	Avellanada	Alomada	Truss	Hexagonal	Avellanada	Alomada	Truss	Hexagonal	Avellanada	Hexagonal sin arandela	Espárrago	Alomada	Truss	Rosca macho	Rosca hembra	Argolla
RECUBRIMIENTO																	
BIMTEAL TECHNOLOGY					✓	✓	✓	✓									
	✓	✓	✓	✓	✓	✓	✓	✓	✓	✓	✓	✓	✓	✓	✓	✓	✓
	✓	✓	✓	✓					✓	✓	✓	✓	✓	✓	✓	✓	✓
	✓	✓	✓	✓	✓	✓	✓	✓	✓	✓	✓	✓	✓	✓	✓	✓	✓
	✓	✓	✓	✓	✓	✓	✓	✓	✓	✓	✓	✓	✓	✓	✓	✓	✓

Anclaje de fijación directa en hormigón Bimetal (cuerpo inoxidable A4 y punta de acero al carbono). Homologado ETE Opt.1

TX

Info Técnica
p. 335

MACIZOS



CÓDIGO	MEDIDA	€/100		ESPESOR MÁX. A FIJAR (MM)	
TXE06040	Ø6 x 40	224,863	10	5	100
TXE06060	Ø6 x 60	251,333	10	5	100
TXE08070	Ø8 x 70	362,343	13	5	50
TXE08080	Ø8 x 80	400,000	13	15	25
TXE08090	Ø8 x 90	450,000	13	25	25
TXE08105	Ø8 x 105	525,027	13	40	25
TXE10070	Ø10 x 70	441,697	15	15	50
TXE10090	Ø10 x 90	567,897	15	5	25
TXE10100	Ø10 x 100	609,187	15	15	25
TXE10120	Ø10 x 120	693,627	15	35	25
TXE12080	Ø12 x 80	659,273	18	5	25
TXE12110	Ø12 x 110	906,500	18	5	25

Info Técnica
p. 335

MACIZOS

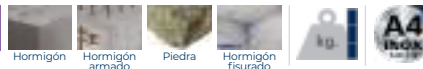

CÓDIGO	MEDIDA	€/100		ESPESOR MÁX. A FIJAR (MM)	
TXA08060	Ø8 x 60	372,600	TX45	10	50
TXA08080	Ø8 x 80	445,003	TX45	15	25
TXA08120	Ø8 x 120	588,647	TX45	55	25
TXA10070	Ø10 x 70	535,117	TX50	15	50
TXA10090	Ø10 x 90	661,480	TX50	5	25
TXA10120	Ø10 x 120	829,027	TX50	35	25

METAL



CÓDIGO	MEDIDA	€/100			
TXP06050	Ø6 x 50	294,162		50	800
TXP06060	Ø6 x 60	311,603		50	600
TXP06080	Ø6 x 80	347,320		50	400
TXP06100	Ø6 x 100	382,173		50	400
TXP08060	Ø8 x 60	358,864		25	400
TXP08080	Ø8 x 80	414,539		25	400

METAL

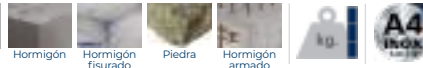

CÓDIGO	MEDIDA	€/100			
TXT06040	Ø6 x 40	270,765		50	1.200
TXT06050	Ø6 x 50	287,504		50	1.200
TXT06060	Ø6 x 60	303,541		50	800

TXE

Homologado ETE Opt.1. Cabeza hexagonal



TXA **NEW**

Homologado ETE Opt.1. Cabeza avellanada



TXP **NEW**

Homologado ETE Opt.1. Cabeza alomada



TXT **NEW**

Homologado ETE Opt.1. Cabeza Truss



TH

Anclaje de fijación directa en hormigón con recubrimiento ATLANTIS C3-H. Homologado ETE Opt.1

THE

Homologado ETE Opt.1. Cabeza hexagonal



02 Info Técnica P. 382

MACIZOS

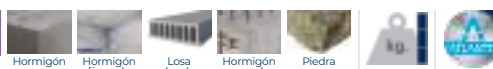

CÓDIGO	HOMOLOGACIÓN SÍSMICA	ØBROCA X LONGITUD	€/100		ESPESOR MÁX. A FIJAR (MM)		
THE05040	-	Ø5 x 40	48,831	8	5	100	2.400
THE05050	-	Ø5 x 50	56,632	8	5	100	1.600
THE05060	-	Ø5 x 60	60,484	8	15	100	1.600
THE05080	-	Ø5 x 80	79,334	8	35	50	800
THE05100	-	Ø5 x 100	92,231	8	55	50	800
THE06035	NEW	Ø6 x 35	60,968	10	-	100	1.600
THE06040	-	Ø6 x 40	61,971	10	5	100	1.600
THE06045	NEW	Ø6 x 45	66,370	10	10	100	1.200
THE06050	-	Ø6 x 50	66,957	10	15	100	1.200
THE06060	C1	Ø6 x 60	74,557	10	5	100	1.200
THE06070	C1	Ø6 x 70	82,631	10	15	50	600
THE06080	C1	Ø6 x 80	92,913	10	25	50	800
THE06100	C1	Ø6 x 100	116,770	10	45	25	400
THE06120	C1	Ø6 x 120	133,118	10	65	25	400
THE08055	C1 & C2	Ø8 x 55	124,734	13	5	50	600
THE08060	C1 & C2	Ø8 x 60	127,211	13	10	50	600
THE08070	C1 & C2	Ø8 x 70	140,333	13	5	50	200
THE08075	NEW	Ø8 x 75	148,795	13	10	25	400
THE08080	C1 & C2	Ø8 x 80	157,177	13	15	25	400
THE08090	C1 & C2	Ø8 x 90	169,660	13	25	25	400
THE08100	C1 & C2	Ø8 x 100	179,080	13	35	25	400
THE08110	C1 & C2	Ø8 x 110	187,161	13	45	25	400
THE08120	C1 & C2	Ø8 x 120	257,114	13	55	25	400
THE08140	C1 & C2	Ø8 x 140	264,608	13	75	25	300
THE10060	-	Ø10 x 60	235,645	15	5	50	200
THE10070	-	Ø10 x 70	255,750	15	15	50	200
THE10080	-	Ø10 x 80	275,162	15	25	50	300
THE10090	C1 & C2	Ø10 x 90	284,787	15	5	25	300
THE10100	C1 & C2	Ø10 x 100	293,892	15	15	25	300
THE10120	C1 & C2	Ø10 x 120	337,762	15	35	25	200
THE10140	C1 & C2	Ø10 x 140	374,703	15	55	25	100
THE10160	NEW	Ø10 x 160	379,691	15	75	25	100
THE10180	NEW	Ø10 x 180	387,700	15	95	25	100
THE12080	-	Ø12 x 80	354,927	18	5	25	100
THE12090	-	Ø12 x 90	379,204	18	15	25	100
THE12100	NEW	Ø12 x 100	395,729	18	25	25	100
THE12110	C1 & C2	Ø12 x 110	433,229	18	5	25	100
THE12130	C1 & C2	Ø12 x 130	498,140	18	25	25	150
THE12150	C1 & C2	Ø12 x 150	551,857	18	45	25	100
THE14080	-	Ø14 x 80	543,868	21	5	25	150
THE14100	-	Ø14 x 100	645,847	21	25	25	150
THE14110	NEW	Ø14 x 110	666,040	21	35	25	100
THE14120	C1 & C2	Ø14 x 120	752,628	21	5	25	100
THE14130	C1 & C2	Ø14 x 130	853,841	21	15	25	100
THE14140	C1 & C2	Ø14 x 140	919,522	21	25	25	100
THE14160	C1 & C2	Ø14 x 160	1.000,393	21	45	25	50
THE16100	-	Ø16 x 100	876,288	-	20	25	100
THE16150	-	Ø16 x 150	1.219,746	-	30	25	75
THE18100	-	Ø18 x 100	1.084,147	24	10	20	80
THE18130	-	Ø18 x 130	1.265,322	24	40	20	40
THE18160	C1 & C2	Ø18 x 160	1.474,997	24	20	15	30
THE18180	C1 & C2	Ø18 x 180	1.595,770	24	40	15	30
THE18200	C1 & C2	Ø18 x 200	1.750,145	24	60	10	20

• Medida sin homologar para fuego

Anclaje de fijación directa en hormigón con recubrimiento ATLANTIS C3-H. Homologado ETE Opt.1

TH

02 Info. Técnica
P. 383

MACIZOS



CÓDIGO	HOMOLOGACIÓN SÍSMICA	ØBROCA X LONGITUD	€/100		ESPESOR MÁX. A FIJAR (MM)		
•THA05040	-	Ø5 x 40	57,643	TX25	5	100	2.400
•THA05060	-	Ø5 x 60	67,897	TX25	15	100	1.200
•THA05080	-	Ø5 x 80	86,051	TX25	35	50	800
•THA05100	-	Ø5 x 100	97,004	TX25	55	50	800
THA06045	C1	Ø6 x 45	80,412	TX30	10	100	1.600
THA06050	C1	Ø6 x 50	83,846	TX30	15	100	1.200
THA06060	C1	Ø6 x 60	98,584	TX30	5	100	1.200
THA06080	C1	Ø6 x 80	118,741	TX30	25	100	600
THA06100	NEW C1	Ø6 x 100	127,242	TX30	45	100	600
THA06120	C1	Ø6 x 120	133,383	TX30	65	100	400
THA06140	C1	Ø6 x 140	171,003	TX30	85	100	600
THA08060	C1 & C2	Ø8 x 60	162,403	TX45	10	50	200
THA08080	C1 & C2	Ø8 x 80	197,347	TX45	15	25	400
THA08100	C1 & C2	Ø8 x 100	237,355	TX45	35	25	400
THA08120	C1 & C2	Ø8 x 120	266,360	TX45	55	25	400
THA10100	C1 & C2	Ø10 x 100	359,559	TX50	15	25	300
THA10120	C1 & C2	Ø10 x 120	417,389	TX50	35	25	200

• Medida sin homologar para fuego

THA

Homologado ETE Opt.1. Cabeza avellanada



02 Info. Técnica
P. 383

MACIZOS



CÓDIGO	HOMOLOGACIÓN SÍSMICA	ØBROCA X LONGITUD	€/100		ESPESOR MÁX. A FIJAR (MM)		
•THP05040	-	Ø5 x 40	56,795	TX30	5	100	2.400
•THP05060	-	Ø5 x 60	65,338	TX30	15	100	1.200
THP06040	-	Ø6 x 40	68,289	TX40	5	100	1.200
THP06050	C1	Ø6 x 50	80,525	TX40	15	100	1.200
THP06060	C1	Ø6 x 60	91,796	TX40	5	100	1.200
THP06080	C1	Ø6 x 80	113,833	TX40	25	50	600
THP06100	C1	Ø6 x 100	135,171	TX40	45	50	200
THP08060	C1 & C2	Ø8 x 60	161,300	TX45	10	25	400
THP08080	C1 & C2	Ø8 x 80	187,412	TX45	15	25	300

• Medida sin homologar para fuego

THP

Homologado ETE Opt.1. Cabeza alomada



02 Info. Técnica
P. 383

MACIZOS

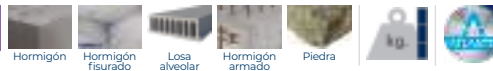

CÓDIGO	HOMOLOGACIÓN SÍSMICA	ØBROCA X LONGITUD	€/100		ESPESOR MÁX. A FIJAR (MM)		
THTO6040	-	Ø6 x 40	88,828	TX30	5	100	1.600
THTO6050	C1	Ø6 x 50	105,746	TX30	15	100	1.200
THTO6060	C1	Ø6 x 60	120,550	TX30	5	100	400

THT

Homologado ETE Opt.1. Cabeza Truss



TF

Anclaje de fijación directa en hormigón con recubrimiento zincado

TFE

Homologado ETE Opt.1. Cabeza hexagonal



02 Info Técnica P. 384

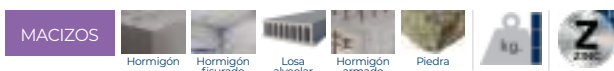

CÓDIGO	HOMOLOGACIÓN SÍSMICA	ØBROCA X LONGITUD	€/100		ESPESOR MÁX. A FIJAR (MM)		
TFE05040	-	Ø5 x 40	41,609	8	5	100	2.400
TFE05050	-	Ø5 x 50	48,262	8	5	100	1.600
TFE05060	-	Ø5 x 60	51,548	8	15	100	1.600
TFE05080	-	Ø5 x 80	67,607	8	35	50	800
TFE05100	-	Ø5 x 100	78,595	8	55	50	800
TFE06035	NEW	Ø6 x 35	52,010	10	-	100	1.600
TFE06040	-	Ø6 x 40	52,809	10	5	100	1.600
TFE06045	NEW	Ø6 x 45	55,737	10	10	100	1.200
TFE06050	-	Ø6 x 50	57,056	10	15	100	1.200
TFE06060	C1	Ø6 x 60	63,536	10	5	100	1.200
TFE06070	C1	Ø6 x 70	70,419	10	15	50	600
TFE06080	C1	Ø6 x 80	79,175	10	25	50	800
TFE06100	C1	Ø6 x 100	99,513	10	45	25	400
TFE06120	C1	Ø6 x 120	113,441	10	65	25	400
TFE08055	C1 & C2	Ø8 x 55	101,682	13	5	50	600
TFE08060	C1 & C2	Ø8 x 60	103,703	13	10	50	600
TFE08070	C1 & C2	Ø8 x 70	114,399	13	5	50	200
TFE08075	NEW	Ø8 x 75	115,675	13	10	25	400
TFE08080	C1 & C2	Ø8 x 80	128,122	13	15	25	400
TFE08090	C1 & C2	Ø8 x 90	138,298	13	25	25	400
TFE08100	C1 & C2	Ø8 x 100	145,980	13	35	25	400
TFE08110	C1 & C2	Ø8 x 110	152,559	13	45	25	400
TFE08120	C1 & C2	Ø8 x 120	209,587	13	55	25	400
TFE08140	C1 & C2	Ø8 x 140	215,699	13	75	25	300
TFE10060	-	Ø10 x 60	183,355	15	5	50	200
TFE10070	-	Ø10 x 70	199,004	15	15	50	200
TFE10080	-	Ø10 x 80	214,106	15	25	50	300
TFE10090	C1 & C2	Ø10 x 90	221,604	15	5	25	300
TFE10100	C1 & C2	Ø10 x 100	228,677	15	15	25	300
TFE10120	C1 & C2	Ø10 x 120	262,820	15	35	25	200
TFE10140	C1 & C2	Ø10 x 140	291,560	15	55	25	100
TFE10160	NEW	Ø10 x 160	308,550	15	75	25	100
TFE10180	NEW	Ø10 x 180	338,096	15	95	25	100
TFE12080	-	Ø12 x 80	263,018	18	5	25	100
TFE12090	-	Ø12 x 90	281,013	18	15	25	100
TFE12100	NEW	Ø12 x 100	289,367	18	25	25	100
TFE12110	C1 & C2	Ø12 x 110	321,042	18	5	25	100
TFE12130	C1 & C2	Ø12 x 130	369,149	18	25	25	150
TFE12150	C1 & C2	Ø12 x 150	408,959	18	45	25	100
TFE14080	-	Ø14 x 80	377,848	21	5	25	150
TFE14100	-	Ø14 x 100	448,694	21	25	25	150
TFE14110	NEW	Ø14 x 110	468,261	21	35	25	100
TFE14120	C1 & C2	Ø14 x 120	522,877	21	5	25	100
TFE14130	C1 & C2	Ø14 x 130	593,197	21	15	25	100
TFE14140	C1 & C2	Ø14 x 140	638,830	21	25	25	100
TFE14160	C1 & C2	Ø14 x 160	695,007	21	45	25	50
TFE16100	-	Ø16 x 100	654,868	-	20	25	100
TFE16150	-	Ø16 x 150	904,325	-	30	25	75
TFE18100	-	Ø18 x 100	753,197	24	10	20	80
TFE18130	-	Ø18 x 130	879,065	24	40	20	40
TFE18160	C1 & C2	Ø18 x 160	1.024,737	24	20	15	30
TFE18180	C1 & C2	Ø18 x 180	1.108,643	24	40	15	30
TFE18200	C1 & C2	Ø18 x 200	1.215,891	24	60	10	20

• Medida sin homologar para fuego

Anclaje de fijación directa en hormigón con recubrimiento zincado

TF



CÓDIGO	MEDIDA	€/100		
•TFA05040	Ø5 x 40	48,996	100	2.400
•TFA05060	Ø5 x 60	57,712	100	1.200
•TFA05080	Ø5 x 80	73,143	50	800
•TFA05100	Ø5 x 100	82,454	50	800
TFA06045	Ø6 x 45	68,350	100	1.600
TFA06050	Ø6 x 50	71,269	100	1.200
TFA06060	Ø6 x 60	81,824	100	1.200
TFA06080	Ø6 x 80	98,555	100	600
TFA06100	Ø6 x 80	105,611	100	600
TFA06120	Ø6 x 120	110,708	100	400
TFA06140	Ø6 x 140	141,932	100	600
TFA08060	Ø8 x 60	131,546	50	200
TFA08080	Ø8 x 80	159,851	25	400
TFA08100	Ø8 x 100	189,884	25	400
TFA08120	Ø8 x 120	213,088	25	400
TFA10100	Ø10 x 100	287,647	25	300
TFA10120	Ø10 x 120	333,911	25	200

• Medida sin homologar para fuego



CÓDIGO	MEDIDA	€/100		
•TFP05040	Ø5 x 40	49,979	25	300
•TFP05060	Ø5 x 60	57,498	100	1.200
TFP06040	Ø6 x 40	60,094	100	1.200
TFP06050	Ø6 x 50	70,862	100	1.200
TFP06060	Ø6 x 60	78,945	100	1.200
TFP06080	Ø6 x 80	96,758	50	600
TFP06100	Ø6 x 100	114,896	50	200
TFP08060	Ø8 x 60	135,492	25	400
TFP08080	Ø8 x 80	157,426	25	300

• Medida sin homologar para fuego



CÓDIGO	MEDIDA	€/100		
TFT06040	Ø6 x 40	75,504	100	1.600
TFT06050	Ø6 x 50	88,826	100	1.200
TFT06060	Ø6 x 60	101,262	100	400



CÓDIGO	MEDIDA	€/100		
TFY08055	Ø8 x 55	326,752	50	300
TFY08075	Ø8 x 75	346,752	50	300
TFY12075	Ø12 x 75	659,955	20	120

TFA **NEW**

Homologado ETE Opt.1. Cabeza avellanada



TFP **NEW**

Homologado ETE Opt.1. Cabeza alomada



TFT **NEW**

Homologado ETE Opt.1. Cabeza Truss



TFY **NEW**

Cabeza argolla



TF

Anclaje de fijación directa en hormigón con recubrimiento zincado

NEW DO-TFY

Útil de colocación para TFY



METAL

CÓDIGO	MEDIDA	€/100	
DOTFY0812	12 x 75	294,222	1

TFN

Homologado ETE Opt.1. Cabeza hexagonal sin arandela



02 Info. Técnica P. 384

MACIZOS



CÓDIGO	ØBROCA X LONGITUD	€/100		ESPOSOR MÁX. A FIJAR (MM)		
TFN14080	Ø14 x 80	543,868	24	5	25	150



TFS

Homologado ETE Opt.1. Espárrago



02 Info. Técnica P. 385

MACIZOS

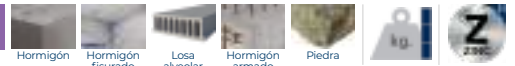

CÓDIGO	HOMOLOGACIÓN SÍSMICA	ØBROCA X LONGITUD	€/100	Nº HUELLA	ESPOSOR MÁX. A FIJAR (MM)		
TFS06100	C1	Ø6 x 100 (M8)	184,744	5	31	50	800
TFS06120	C1	Ø6 x 120 (M8)	204,816	5	51	50	600
TFS08110	C1 & C2	Ø8 x 110 (M10)	273,856	7	29	50	400
TFS08130	C1 & C2	Ø8 x 130 (M10)	304,532	7	49	50	400
TFS10120	C1 & C2	Ø10 x 120 (M12)	398,860	8	26	25	200
TFS10140	C1 & C2	Ø10 x 140 (M12)	444,620	8	47	25	200



TFF

Homologado ETE Opt.1. Rosca hembra métrica



02 Info. Técnica P. 385

MACIZOS

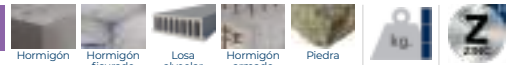

CÓDIGO	ØBROCA X LONGITUD	€/100			
TFF05035S NEW	Ø5 x 35 (M6)	107,097	10	50	1.200
TFF06035	Ø6 x 35 (M8-M10)	140,856	13	50	200
TFF06040 NEW	Ø6 x 40 (M8-M10)	141,546	13	50	200
TFF06055	Ø6 x 55 (M8-M10)	152,085	13	50	200
TFF08050T NEW	Ø8 x 50 (M10)	154,874	13	50	600
TFF08050W NEW	Ø8 x 50 (M12)	181,169	17	50	600

• Medida sin homologar para fuego



Anclaje de fijación directa en hormigón con recubrimiento zincado

TF

02 Info
Técnica
p. 335

MACIZOS



CÓDIGO	Ø BROCA X LONGITUD	€/100	Nº HUELLA		
TFM06035	Ø6 x 35 (M8)	116,169	13	100	400
TFM06055	Ø6 x 55 (M10)	136,436	13	100	600

TFM

Homologado ETE Opt.1. Rosca macho métrica



Tornillo para fijación directa

HO

02 Info
Técnica
p. 336

MACIZOS



CÓDIGO	MEDIDA	€/100	LLAVE DE INSTALACIÓN	Ø BROCA		
• HP75072	7,5 x 72 Ø6	33,757	TX30	6	100	1.200
• HP75092	7,5 x 92 Ø6	41,577	TX30	6	100	1.200
• HP75112	7,5 x 112 Ø6	53,317	TX30	6	100	800
• HP75132	7,5 x 132 Ø6	61,133	TX30	6	100	600
• HP75152	7,5 x 152 Ø6	79,590	TX30	6	100	600
• HP75182	7,5 x 182 Ø6	116,897	TX30	6	100	300

HP

Cabeza plana, TX. Bicromatado



• Hasta fin de existencias

02 Info
Técnica
p. 336

MACIZOS



CÓDIGO	MEDIDA	€/100	LLAVE DE INSTALACIÓN	Ø BROCA		
HPZ75052	NEW 7,5 x 52 Ø6	23,114	TX30	6	100	1.200
HPZ75062	NEW 7,5 x 62	25,622	TX30	6	100	1.200
HPZ75072	7,5 x 72 Ø6	33,757	TX30	6	100	1.200
HPZ75082	NEW 7,5 x 82 Ø6	34,049	TX30	6	100	120
HPZ75092	7,5 x 92 Ø6	41,577	TX30	6	100	1.200
HPZ75102	NEW 7,5 x 102 Ø6	46,539	TX30	6	100	1.200
HPZ75112	7,5 x 112 Ø6	53,317	TX30	6	100	800
HPZ75122	NEW 7,5 x 122 Ø6	56,200	TX30	6	100	600
HPZ75132	7,5 x 132 Ø6	61,133	TX30	6	100	600
HPZ75152	7,5 x 152 Ø6	79,590	TX30	6	100	600
HPZ75182	7,5 x 182 Ø6	116,897	TX30	6	100	300
HPZ75212	7,5 x 212 Ø6	164,213	TX30	6	100	300
HPZ75252	NEW 7,5 x 252 Ø6	462,004	TX30	6	100	200

HPZ

Cabeza plana, TX. Zincado



MACIZOS

PVC

CÓDIGO	COLOR	€/100	LLAVE DE INSTALACIÓN		
TPBLANC	BLANCO	5,097	TX30	2.000	24.000
TPMARRO	MARRÓN	5,097	TX30	2.000	24.000

HP TP

Tapón para tornillo HP



HO

Tornillo para fijación directa

HR

Cabeza cilíndrica, TX



CÓDIGO	MEDIDA	€/100	LLAVE DE INSTALACIÓN	Ø BROCA		
HR75072	7,5 x 72 Ø6	36,293	TX30	6	100	1.200
HR75092	7,5 x 92 Ø6	43,033	TX30	6	100	1.200
HR75112	7,5 x 112 Ø6	60,210	TX30	6	100	800
HR75132	7,5 x 132 Ø6	67,557	TX30	6	100	600

HEA

Tornillo con cabeza hexagonal

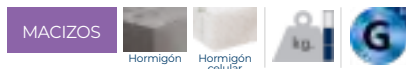

CÓDIGO	MEDIDA	€/100	LLAVE DE INSTALACIÓN	Ø BROCA		
HE65032	6,5 x 32 Ø5	16,187	8+ ranura	5	1.000	3.000
HE65045	6,5 x 45 Ø5	19,890	8+ ranura	5	500	2.000
HE65057	6,5 x 57 Ø5	25,653	8+ ranura	5	500	2.000
HE65070	6,5 x 70 Ø5	32,773	8+ ranura	5	500	1.500
HE65080	6,5 x 80 Ø5	39,043	8+ ranura	5	250	1.000
HE65100	6,5 x 100 Ø5	47,730	8+ ranura	5	250	750
HE65115	6,5 x 115 Ø5	54,050	8+ ranura	5	250	1.000
HE65125	6,5 x 125 Ø5	63,117	8+ ranura	5	250	1.000
HE65150	6,5 x 150 Ø5	74,237	8+ ranura	5	250	750
HE65180	6,5 x 180 Ø5	119,437	8+ ranura	5	100	400
HE65200	6,5 x 200 Ø5	153,033	8+ ranura	5	100	300

HEA + ARVUL

Tornillo montado con arandela vulcanizada de acero-EPDM



CÓDIGO	MEDIDA	€/100	LLAVE DE INSTALACIÓN	Ø BROCA		
HE1665032	6,5 x 32 P16 Ø5	24,810	8+ ranura	5	1.000	2.000
HE1665045	6,5 x 45 P16 Ø5	29,217	8+ ranura	5	500	1.500
HE1665057	6,5 x 57 P16 Ø5	35,637	8+ ranura	5	500	1.500
HE1665070	6,5 x 70 P16 Ø5	40,337	8+ ranura	5	500	1.000
HE1665080	6,5 x 80 P16 Ø5	48,537	8+ ranura	5	250	750
HE1665100	6,5 x 100 P16 Ø5	56,797	8+ ranura	5	250	750
HE1665115	6,5 x 115 P16 Ø5	66,160	8+ ranura	5	250	750
HE1665125	6,5 x 125 P16 Ø5	72,070	8+ ranura	5	250	500
HE1665150	6,5 x 150 P16 Ø5	85,446	8+ ranura	5	250	500
HE1665180	6,5 x 180 P16 Ø5	135,178	8+ ranura	5	100	300
HE1665200	6,5 X 200 P16 Ø5	173,202	8+ ranura	5	100	300

Anclaje para grandes cargas en hormigón

SL

02
P. 388
Info
Técnica

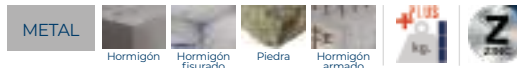

CÓDIGO	MEDIDA	€/100	ESPESOR MÁX. A FIJAR (MM)		
SLPE12095	M8 x 95 Ø12	483,730	20	50	200
SLPE12155	M8 x 155 Ø12	672,878	80	25	100
SLPE16125	M10 x 125 Ø16	733,921	40	25	100
SLPE16160	M10 x 160 Ø16	865,684	75	20	60
SLPE16245	M10 x 245 Ø16	1.259,677	160	10	20
SLPE18150	M12 x 150 Ø18	1.023,624	50	20	40
SLPE18170	M12 x 170 Ø18	1.118,076	70	15	45
SLPE18260	M12 x 260 Ø18	1.442,287	160	5	10
SLPE24145	M16 x 145 Ø24	1.671,791	25	10	40
SLPE24170	M16 x 170 Ø24	1.842,453	50	10	30
SLPE24200	M16 x 200 Ø24	2.068,678	80	10	20
SLPE24280	M16 x 280 Ø24	2.747,179	160	5	10
SLPE28210	M20 x 210 Ø28	3.263,075	60	5	10
SLPE28230	M20 x 230 Ø28	3.590,872	80	5	10
SLPE28310	M20 x 310 Ø28	4.393,954	160	5	10

SL-PE **NEW**

Homologado ETE Opt.1. Espárrago



02
P. 387
Info
Técnica

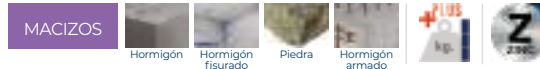

CÓDIGO	MEDIDA	€/100	ESPESOR MÁX. A FIJAR (MM)		
SLPT10070	M6 x 70 Ø10	270,130	10	50	600
SLPT10080	M6 x 80 Ø10	283,443	20	50	600
SLPT10100	M6 x 100 Ø10	316,343	40	50	300
SLPT10110	M6 x 110 Ø10	335,900	50	25	150
SLPT12080	M8 x 80 Ø12	325,683	5	50	300
SLPT12090	M8 x 90 Ø12	342,817	15	50	200
SLPT12100	M8 x 100 Ø12	357,267	25	50	200
SLPT12120	M8 x 120 Ø12	390,040	45	25	200
SLPT16100	M10 x 100 Ø16	557,040	15	25	150
SLPT16120	M10 x 120 Ø16	629,300	35	25	100
SLPT16140	M10 x 140 Ø16	710,640	55	20	60
SLPT16160	M10 x 160 Ø16	790,777	75	20	60
SLPT18110	M12 x 110 Ø18	775,527	10	20	80
SLPT18120	M12 x 120 Ø18	824,407	20	20	80
SLPT18140	M12 x 140 Ø18	910,163	40	20	80
SLPT18150	M12 x 150 Ø18	962,467	50	20	80
SLPT18170	M12 x 170 Ø18	1.081,263	70	15	45
SLPT18200	M12 x 200 Ø18	1.209,170	100	15	30
SLPT24140	M16 x 140 Ø24	1.397,613	20	10	40
SLPT24170	M16 x 170 Ø24	1.643,390	50	10	30
SLPT24200	M16 x 200 Ø24	1.896,213	80	10	20
SLPT24220	M16 x 220 Ø24	2.059,910	100	10	20
SLPT28170	M20 x 170 Ø28	2.173,433	20	10	20
SLPT28200	M20 x 200 Ø28	2.516,480	50	10	20
SLPT28240	M20 x 240 Ø28	2.999,587	90	5	10

SL-PT

Homologado ETE Opt.1. Cabeza hexagonal



02
P. 387
Info
Técnica

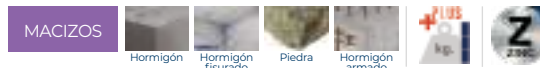

CÓDIGO	MEDIDA	€/100	ESPESOR MÁX. A FIJAR (MM)		
SLPC10070	M6 x 70 Ø10	382,000	10	50	600
SLPC10080	M6 x 80 Ø10	402,713	20	50	600
SLPC10100	M6 x 100 Ø10	440,177	40	50	300
SLPC12100	M8 x 100 Ø12	523,453	25	50	200
SLPC16100	M10 x 100 Ø16	755,880	15	25	150
SLPC16120	M10 x 120 Ø16	820,767	35	25	100
SLPC18120	M12 x 120 Ø18	1.016,850	20	20	80

SL-PC

Homologado ETE Opt.1. Cabeza avellanada



Los anclajes de camisa CH son una solución ideal para la instalación de elementos estructurales en hormigón no fisurado como pasamanos, líneas de cables, mobiliario urbano o estanterías metálicas.

La geometría del anclaje garantiza una gran capacidad de carga, un alto grado de seguridad y una sencilla instalación. Al apretar el anclaje, el cono se introduce en la camisa de expansión (sin girarse gracias a los antiguos), expandiéndola contra el material a fijar. El surtido de anclajes CH consta de diferentes modelos de cabezas en función del uso que se requiera.



DISEÑO Y GEOMETRÍA



- 1. Cono con aletas antigiro** permite que el anclaje no gire, asegurando la expansión de la camisa y facilitando su instalación.
- 2. Apertura de la camisa.** Optimiza la inserción del cono y facilita su expansión.
- 3. Información práctica** para la instalación (diámetro y longitud) estampada en la camisa.
- 4. Diseño de la camisa** para asegurar una expansión más eficiente.
- 5. Marca de profundidad** requerida para asegurar un correcto rendimiento.
- 6. Goma azul** con aletas antigiro que facilitan la instalación.
- 7. Arandela** que aumenta la superficie de fijación.

CUALIDADES Y VENTAJAS



GARANTÍA ANTIGIRO. FACILITA LA INSTALACIÓN.

El anclaje consta de varios elementos antigiro (cono, camisa y goma) que permiten que el anclaje no gire cuando se comienza a instalar, facilitando la instalación y garantizando una óptima expansión y rendimiento.



MÁXIMAS GARANTÍAS. HOMOLOGADO ACORDE A LOS MÁX ALTOS ESTÁNDARES DE CALIDAD.

Homologado (ETA 18/0018) para usos no estructurales en hormigón.



VERSÁTILIDAD. MÚLTIPLES USOS.

Indicado para la instalación de cargas estáticas o cuasi-estáticas en hormigón no fisurado y hormigón armado. Permite el desmontaje del anclaje, desatornillando el tornillo o elemento roscado.

APLICACIONES



- Fijaciones estructurales en hormigón no fisurado.
- Fijación de señales, estanterías, paneles, pórticos, barandillas, toldos, postes de vallas.
- Mobiliario urbano, asientos de cines, teatros o estadios.
- Bandejas de cables
- Puertas
- Fachadas
- Fijaciones temporales

FABRICACIÓN 100% INDEX

Esto nos permite asegurar un riguroso control de los procesos, garantizando la máxima calidad en nuestros productos, brindar el mejor servicio y obtener un coste global competitivo.

GAMA



PRODUCTO	CH-TO	CH-A2	CH-8.8	CH-8.8 E	CH-PL	CH-PI	CH-ES	CH-INB	CH-INN
CABEZA DEL TORNILLO	Tornillo hexagonal 6.8	Tornillo hexagonal inoxidable A2	Tornillo hexagonal 8.8	Tornillo especial para espesores reducidos	Cabeza plana	Cabeza plana inoxidable A2	Espárrago	Cabeza inviolable	Cabeza inviolable lacada en negro
RECUBRIMIENTO/MATERIAL DEL TORNILLO	Zinc	A2 INOX	Zinc	Zinc	Zinc	A2 INOX	Zinc	Zinc	A2 INOX



PRODUCTO	CH-GA	CH-GE	CH-GF	CH-GF A2	CH-AR	CH-AF	CH-AF A2
CABEZA DEL TORNILLO	Gancho	Gancho espiral	Gancho forjado	Gancho forjado inoxidable A2	Argolla	Argolla forjada	Argolla forjada inoxidable A2
RECUBRIMIENTO/MATERIAL DEL TORNILLO	Zinc	Zinc	Zinc	A2 INOX	Zinc	Zinc	A2 INOX

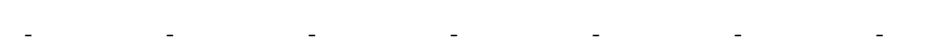

EL RECUBRIMIENTO PERFECTO SEGÚN EL NIVEL DE CORROSIÓN



Recubrimiento Cincado: apto para uso en condiciones interiores secas (categoría C1 según la norma ISO 923), por un periodo de 50 años.



Recubrimiento Cincado negro: apto para uso en condiciones interiores secas (categoría C1 según la norma ISO 923), por un periodo de 50 años.



Material Inoxidable A2: válido para espacios interiores con alta frecuencia de condensación o ambientes exteriores que no estén situados próximas a zonas costeras o de elevada contaminación.

Anclaje camisa antigiro para cargas medias

CH

Info Técnica
P. 388

MACIZOS

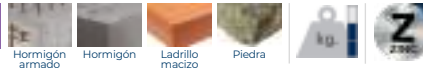

CÓDIGO	MEDIDA	€/100		
ACHT08C	M6 x 45 Ø8	31,225	200	1.200
• ACHT09C	M6 x 45 Ø9	39,460	200	800
ACHT08L	M6 x 60 Ø8	36,532	200	800
• ACHT09L	M6 x 60 Ø9	45,098	200	800
ACHT10C	M8 x 60 Ø10	49,978	100	600
• ACHT11C	M8 x 60 Ø11	60,500	100	400
ACHT10L	M8 x 80 Ø10	58,700	100	400
• ACHT11L	M8 x 80 Ø11	72,193	100	400
ACHT12C	M10 x 70 Ø12	79,887	100	200
• ACHT14C	M10 x 70 Ø14	101,653	100	200
ACHT12L	M10 x 100 Ø12	98,914	50	200
• ACHT14L	M10 x 100 Ø14	123,560	50	200
ACHT16C	M12 x 80 Ø16	154,895	50	200
ACHT16L	M12 x 110 Ø16	187,937	50	100
ACHT20C	M16 x 110 Ø20	341,953	25	50
• ACHT25C	M20 x 130 Ø25	987,013	15	45

CH-TO

Tornillo hexagonal 6.8. Homologado ETE Opt.7



• Medidas sin homologar

Blíster

CÓDIGO	MEDIDA	€/BOLSA	PCS	BOLSAS
BZACHT08C	M6 x 45 Ø8	3,377	2	15
BZACHT08L	M6 x 60 Ø8	3,377	2	15
BZACHT10C	M8 x 60 Ø10	3,377	2	15
BZACHT10L	M8 x 80 Ø10	3,377	2	15
BZACHT12C	M10 x 70 Ø12	3,377	2	10
BZACHT12L	M10 x 100 Ø12	3,377	2	10

Caja ventana

CÓDIGO	MEDIDA	€/CAJA	PCS	CAJAS
VACHT08C	M6 x 45 Ø8	6,039	15	8
VACHT08L	M6 x 60 Ø8	6,797	15	8
VACHT10C	M8 x 60 Ø10	6,396	10	8
VACHT10L	M8 x 80 Ø10	7,497	10	8
VACHT12C	M10 x 70 Ø12	8,079	8	8
VACHT12L	M10 x 100 Ø12	7,683	6	8
VACHT16C	M12 x 80 Ø16	7,770	4	8

Info Técnica
P. 388

INOXIDABLE

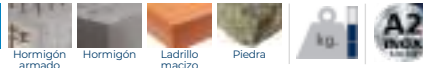

CÓDIGO	MEDIDA	€/100		
ACHTA208C	M6 x 45 Ø8	109,583	100	1.200
• ACHTA209C	M6 x 45 Ø9	124,010	100	1.200
ACHTA208L	M6 x 60 Ø8	123,800	100	600
• ACHTA209L	M6 x 60 Ø9	143,233	100	600
ACHTA210C	M8 x 60 Ø10	177,550	100	600
• ACHTA211C	M8 x 60 Ø11	213,603	100	400
ACHTA210L	M8 x 80 Ø10	204,243	100	400
• ACHTA211L	M8 x 80 Ø11	251,620	100	400
ACHTA212C	M10 x 70 Ø12	299,513	100	200
• ACHTA214C	M10 x 70 Ø14	398,427	100	300
ACHTA212L	M10 x 100 Ø12	366,293	50	200
• ACHTA214L	M10 x 100 Ø14	444,400	50	200
ACHTA216C	M12 x 80 Ø16	590,597	50	100
ACHTA216L	M12 x 110 Ø16	747,340	50	100
ACHTA220C	M16 x 110 Ø20	1.534,333	25	75

CH-A2

Inoxidable A2. Homologado ETE Opt.7



• Medidas sin homologar

Caja ventana

CÓDIGO	MEDIDA	€/CAJA	PCS	CAJAS
VACHTA208C	M6 x 45 Ø8	12,948	10	8
VACHTA208L	M6 x 60 Ø8	15,055	10	8
VACHTA210C	M8 x 60 Ø10	13,481	6	8
VACHTA210L	M8 x 80 Ø10	16,052	6	8
VACHTA212C	M10 x 70 Ø12	15,128	4	8
VACHTA212L	M10 x 100 Ø12	18,672	4	8

CH

Anclaje camisa antigiro para cargas medias

CH-8.8

Tornillo hexagonal 8.8. Homologado ETE Opt.7



02 Info. Técnica P. 389

MACIZOS

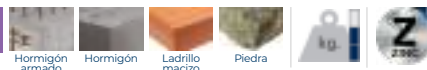

CÓDIGO	MEDIDA	€/100		
ACHT8808C	M6 x 45 Ø8	34,447	200	1.200
ACHT8808L	M6 x 60 Ø8	40,157	200	800
ACHT8810C	M8 x 60 Ø10	55,063	100	600
ACHT8810L	M8 x 80 Ø10	64,800	100	400
ACHT8812C	M10 x 70 Ø12	89,447	100	200
ACHT8812L	M10 x 100 Ø12	109,243	50	200
ACHT8816C	M12 x 80 Ø16	172,513	50	200
ACHT8816L	M12 x 110 Ø16	209,530	50	100
ACHT8820C	M16 x 110 Ø20	379,137	25	50

CH-8.8 E

Tornillo hexagonal 8.8 para espesores reducidos



02 Info. Técnica P. 389

MACIZOS

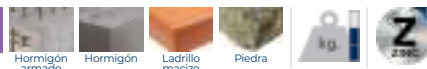

CÓDIGO	MEDIDA	€/100		
ACHT8808E	M6 x 40 Ø8	42,023	200	1.200
ACHT8810E	M8 x 40 Ø10	68,141	100	600

CH-PL

Cabeza plana. Homologado ETE Opt.7



02 Info. Técnica P. 389

MACIZOS

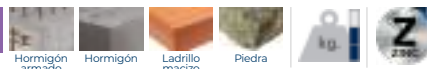

CÓDIGO	MEDIDA	€/100		
ACHTPL08C	M6 x 45 Ø8	51,120	4	1.600
ACHTPL08L	M6 x 60 Ø8	74,970	4	1.200
ACHTPL10C	M8 x 60 Ø10	84,007	5	400
ACHTPL10L	M8 x 80 Ø10	113,247	5	600
ACHTPL12C	M10 x 70 Ø12	148,747	6	400
ACHTPL12L	M10 x 100 Ø12	255,027	6	300

CH-PI

Cabeza plana inoxidable A2. Homologado ETE Opt.7



02 Info. Técnica P. 389

INOXIDABLE

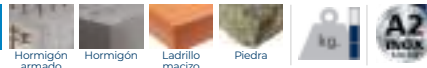

CÓDIGO	MEDIDA	€/100		
ACHTPI08C	M6 x 45 Ø8	113,997	4	1.200
ACHTPI08L	M6 x 60 Ø8	138,665	4	1.200
ACHTPI10C	M8 x 60 Ø10	204,304	5	600
ACHTPI10L	M8 x 80 Ø10	241,854	5	400
ACHTPI12C	M10 x 70 Ø12	323,051	6	300
ACHTPI12L	M10 x 100 Ø12	401,477	6	300

Anclaje camisa antigiro para cargas medias

CH



MACIZOS

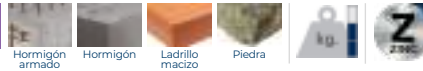

CÓDIGO	MEDIDA	€/100			
ACHINB08C	M6 x 45 Ø8	52,660	TX40	100	1.200
ACHINB08L	M6 x 60 Ø8	60,353	TX40	100	800
ACHINB10C	M8 x 60 Ø10	74,683	TX40	100	600
ACHINB10L	M8 x 80 Ø10	88,083	TX40	100	400



CÓDIGO	MEDIDA	€/BOLSA	PCS BOLSAS	BOLSAS
BZACHINB08C	M6 x 45 Ø8	3,377	2	15
BZACHINB10C	M8 x 60 Ø10	3,377	2	15

CH-INB

Cabeza inviolable zincada.
Homologado ETE Opt.7



MACIZOS

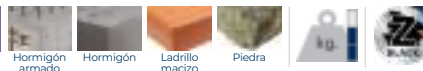

CÓDIGO	MEDIDA	€/100			
ACHINN08C	M6 x 45 Ø8	64,173	TX40	100	1.200
ACHINN08L	M6 x 60 Ø8	71,893	TX40	100	800
ACHINN10C	M8 x 60 Ø10	86,377	TX40	100	600
ACHINN10L	M8 x 80 Ø10	103,740	TX40	100	400

CH-INN

Cabeza inviolable zincada negra.
Homologado ETE Opt.7



MACIZOS

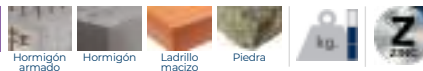

CÓDIGO	MEDIDA	€/100		
ACHE08C	M6 x 45 Ø8	62,460	200	1.200
ACHE09C	M6 x 45 Ø9	64,650	200	800
ACHE10C	M8 x 60 Ø10	92,387	100	600
ACHE11C	M8 x 60 Ø11	101,880	100	600
ACHE10L	M8 x 80 Ø10	107,580	100	400
ACHE11L	M8 x 80 Ø11	112,593	100	400
ACHE12C	M10 x 70 Ø12	130,913	100	200
ACHE14C	M10 x 70 Ø14	143,973	100	200
ACHE12L	M10 x 100 Ø12	171,337	50	200
ACHE14L	M10 x 100 Ø14	193,340	50	200

CH-ES

Espárrago



CH

Anclaje camisa antigiro para cargas medias

CH-GA

Gancho



02 Info. Técnica P. 389

MACIZOS

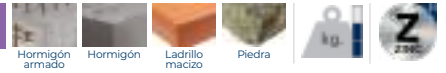

CÓDIGO	MEDIDA	€/100	APERTURA GANCHO		
ACHG08C	M6 x 45 Ø8	56,567	10	100	600
ACHG09C	M6 x 45 Ø9	61,927	10	100	600
ACHG10C	M8 x 60 Ø10	91,265	13	100	400
ACHG11C	M8 x 60 Ø11	102,533	13	100	400
ACHG12C	M10 x 70 Ø12	146,126	14	50	200
ACHG14C	M10 x 70 Ø14	169,205	14	50	200
ACHG16C	M12 x 80 Ø16	270,737	22	25	100

02 Info. Técnica P. 389 Blíster

CÓDIGO	MEDIDA	€/BOLSA	PCS	BOLSAS
BZACHG08C	M6 x 45 Ø8	3,377	2	15
BZACHG10C	M8 x 60 Ø10	3,377	2	15
BZACHG12C	M10 x 70 Ø12	3,377	2	10

02 Info. Técnica P. 389 Caja ventana

CÓDIGO	MEDIDA	€/CAJA	PCS	CAJAS
VACHG08C	M6 x 45 Ø8	6,748	10	8
VACHG10C	M8 x 60 Ø10	6,848	6	8

CH-GE

Gancho espiral



02 Info. Técnica P. 390

MACIZOS

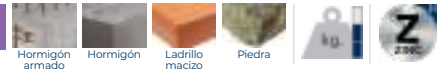

CÓDIGO	MEDIDA	€/100		
ACHGE10	M8 x 115 Ø10	197,917	25	200
ACHGE12	M10 x 135 Ø12	239,850	15	90

CH-GF

Gancho forjado



02 Info. Técnica P. 390

MACIZOS

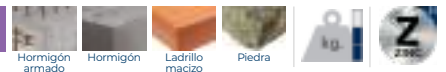

CÓDIGO	MEDIDA	€/100	APERTURA GANCHO		
ACHGF008C	M6 x 45 Ø8	112,207	10	100	600
ACHGF010C	M8 x 60 Ø10	152,787	11	100	400
ACHGF012C	M10 x 70 Ø12	238,263	14	50	200

CH-GF A2

Gancho forjado. Inoxidable A2



02 Info. Técnica P. 390

INOXIDABLE

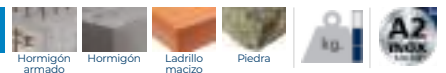

CÓDIGO	MEDIDA	€/100	APERTURA GANCHO		
ACHGA208C	M6 x 45 Ø8	447,373	10	100	600
ACHGA210C	M8 x 60 Ø10	664,537	11	100	400
ACHGA212C	M10 x 70 Ø12	881,317	14	50	200

Anclaje camisa antigiro para cargas medias

CH

02 Info Técnica
P. 390

MACIZOS

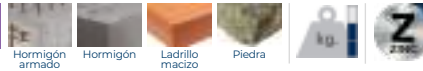

CÓDIGO	MEDIDA	€/100	Ø OJO		
ACHA08C	M6 x 45 Ø8	56,567	10	100	600
ACHA09C	M6 x 45 Ø9	61,927	10	100	600
ACHA10C	M8 x 60 Ø10	91,265	13	100	400
ACHA11C	M8 x 60 Ø11	102,533	13	100	200
ACHA12C	M10 x 70 Ø12	146,126	14	50	200
ACHA14C	M10 x 70 Ø14	169,205	14	50	200
ACHA16C	M12 x 80 Ø16	270,737	22	25	100

CH-AR

Argolla



02 Info Técnica
P. 390

Blíster

CÓDIGO	MEDIDA	€/BOLSA	PCS	BOLSAS
BZACHA08C	M6 x 45 Ø8	3,377	2	15
BZACHA10C	M8 x 60 Ø10	3,377	2	15
BZACHA12C	M10 x 70 Ø12	3,377	2	10

02 Info Técnica
P. 390

Caja ventana

CÓDIGO	MEDIDA	€/CAJA	PCS	CAJAS
VACHA08C	M6 x 45 Ø8	7,083	10	8
VACHA10C	M8 x 60 Ø10	7,061	6	8

02 Info Técnica
P. 390

MACIZOS

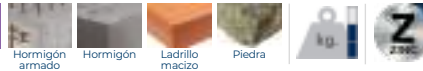

CÓDIGO	MEDIDA	€/100	Ø OJO		
ACHAFO08C	M6 x 45 Ø8	108,830	10	100	600
ACHAFO10C	M8 x 60 Ø10	142,155	12	100	400
ACHAFO12C	M10 x 70 Ø12	219,244	14	50	200

CH-AF

Argolla forjada



02 Info Técnica
P. 390

INOXIDABLE

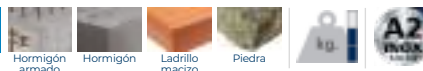

CÓDIGO	MEDIDA	€/100	Ø OJO		
ACHAA208C	M6 x 45 Ø8	491,243	10	100	600
ACHAA210C	M8 x 60 Ø10	783,613	11	100	400
ACHAA212C	M10 x 70 Ø12	1.045,200	14	50	200

CH-AF A2

Argolla forjada. Inoxidable A2



Disponibles ganchos y argollas por separado en la página 326



HE

Los anclajes de expansión por deformación con rosca hembra están indicados para la instalación de tuberías, bandejas porta cables, conductos de ventilación o sistemas rociadores contra incendios. Disponen de homologación europea ETE para aplicaciones estructurales en hormigón no fisurado (según DEE 332023) y para fijación de sistemas redundantes no estructurales en hormigón fisurado incluyendo condiciones de exposición a fuego (según DEE 330747). Disponibles con recubrimiento ATLANTIS C3-L, inoxidable A4 y cincado, permitiendo su instalación en aplicaciones interiores como exteriores.



DISEÑO Y GEOMETRÍA



Rosca interior. El anclaje tiene una primera parte con rosca hembra, donde se instala el perno métrico y/o la varilla roscada (no suministrada con el producto). Su rosca interna métrica permite la aplicación en múltiples instalaciones, garantizando una máxima versatilidad.



Cono interior. En la parte inferior dispone de un cono interior que durante la instalación produce una expansión de las aletas de la camisa.



Aletas. La expansión del cono interior produce una expansión de las aletas, generando un rozamiento contra las paredes del material base, que permite la fijación.



Protección. El plástico ubicado en el interior del anclaje, evita que el cono se caiga durante la instalación o transporte de la caja.



Versión con collarín HE-CL. La versión con collarín previene que el anclaje se introduzca en exceso en el agujero del material base durante la instalación en caso de haber realizado un agujero más profundo del requerido en la documentación.



Identificación. La medida del anclaje está troquelada en el cuerpo del anclaje para facilitar su identificación y así saber en todo momento el diámetro de broca necesario, así como el útil de expansión a utilizar.



Versión corta, HE-HC. La versión HE-HC permite la instalación en zonas donde se presuma una alta densidad de armaduras de refuerzo; por ejemplo, en la parte inferior de forjados. Dada su escasa longitud (25 mm) no es previsible que incida en la armadura.

APLICACIONES



Anclaje para fijación de sistemas estructurales y no estructurales

- Instalaciones de techos suspendidos
- Sistemas de rociadores contra incendios
- Sistemas de suspensión para tuberías
- Bajantes con varillas
- Sistemas de ventilación y/o conductos de aire
- Bandejas portacables
- Fijación de sistemas estructurales en hormigón no fisurado con cargas estáticas o cuasi-estáticas
- Fijación de sistemas no estructurales redundantes en hormigón fisurado o aplicaciones puntuales en hormigón no fisurado.

FABRICACIÓN 100% INDEX

Esto nos permite asegurar un riguroso control de los procesos, garantizar la máxima calidad en nuestros productos, brindar el mejor servicio y obtener un coste global competitivo.

CUALIDADES Y VENTAJAS

ANCLAJE DESMONTABLE Y REUTILIZABLE.

Los tornillos o varillas utilizados pueden ser desmontados, dejando la superficie diáfana (queda la camisa y el cono en el interior del taladro). El anclaje instalado se puede utilizar para una nueva fijación.

MÁXIMAS GARANTÍAS. PRODUCTOS HOMOLOGADOS ACORDE A LOS MÁS ALTOS ESTÁNDARES DE CALIDAD.

- Homologado (ETA 14/0135) para sistemas no estructurales redundantes en hormigón fisurado y no fisurado (C12/15 a C50/60), incluyendo condiciones de exposición a fuego.
- Homologado (ETA 14/0068) para aplicaciones estructurales en hormigón no fisurado (C20/25-C50/60).
- Homologado FM para instalación de sistemas de rociadores contra incendios.
- Confirmada idoneidad para la instalación de sistemas de rociadores según la norma VdS CEA 4001.



FÁCIL INSTALACIÓN.

Gracias al útil EXP con protector de goma, permite una expansión del anclaje controlada, segura y ergonómica.

¿Cómo saber si el anclaje está correctamente instalado?

Una vez introducida la camisa, golpear con el expansionador hasta que el borde superior de la camisa se quede marcada con unas muescas.



GAMA



PRODUCTO	HE-HO	HE-A4	HE-CL	HE-C4	HE-HC	HE-NO	HE-NS
RECUBRIMIENTO/MATERIAL	Z	A4	Z	A4	Z	Z	A4
CE	✓	✓	✓	✓	✓	✓	✓
CE	✓	✓	✓	✓	✓	✓	✓
Fuego	✓	✓	✓	✓	✓	✓	✓
FM	✓	✓	✓	✓	✓	✓	✓
ETA	✓	✓	✓	✓	✓	✓	✓

EL RECUBRIMIENTO PERFECTO SEGÚN EL NIVEL DE CORROSIÓN



Recubrimiento Atlantis C3-L: válido para condiciones interiores secas (50 años) o en ambientes exteriores tipo C3 según la norma ISO 9223, por un periodo de 25 años.



Recubrimiento Cincado: apto para uso en condiciones interiores secas (categoría C1 según la norma ISO 9223), por un periodo de 50 años.



Material Inoxidable A4: válido para interior y exterior, en zonas costeras o industriales, zonas expuestas a alta contaminación o zonas cercanas a carreteras.

Anclaje hembra con cono interior para grandes cargas

HE

02 Info
Técnica
p. 390

MACIZOS

CÓDIGO	MEDIDA	€/100		
HEHOM06	M6 x 25 Ø8	17,570	100	3.200
HEHOM08	M8 x 30 Ø10	22,392	100	1.600
HEHOM10	M10 x 40 Ø12	33,915	50	800
HEHOM12	M12 x 50 Ø15	58,884	50	400
HEHOM12D	M12 x 50 Ø16	76,600	50	400
HEHOM16	M16 x 65 Ø20	183,277	25	200
HEHOM20	M20 x 80 Ø25	392,043	25	100

HE-HO

Zincado. Homologado ETE Opt.7 y para aplicaciones no estructurales



02 Info
Técnica
p. 391

INOXIDABLE

CÓDIGO	MEDIDA	€/100		
HEA4M06	M6 x 25 Ø8	102,750	100	4.000
HEA4M08	M8 x 30 Ø10	146,510	100	1.600
HEA4M10	M10 x 40 Ø12	231,770	50	800
HEA4M12	M12 x 50 Ø15	438,380	50	600
HEA4M16	M16 x 65 Ø20	930,627	25	250
HEA4M20	M20 x 80 Ø25	1.784,273	25	100

HE-A4

Inoxidable A4. Homologado ETE Aplicaciones no estructurales



02 Info
Técnica
p. 391

MACIZOS

CÓDIGO	MEDIDA	€/100		
HECLOM06	M6 x 25 Ø8	22,442	100	3.200
HECLOM08	M8 x 30 Ø10	27,660	100	1.600
HECLOM10	M10 x 40 Ø12	43,243	50	800
HECLOM12	M12 x 50 Ø15	76,733	50	400
HECLOM12D	M12 x 50 Ø16	89,807	50	400
HECLOM16	M16 x 65 Ø20	247,057	25	200

HE-CL

Con collarín. Zincado. Homologado ETE Opt.7 y para aplicaciones no estructurales



02 Info
Técnica
p. 391

INOXIDABLE

CÓDIGO	MEDIDA	€/100		
HEC4M06	M6 x 25 Ø8	141,623	100	3.200
HEC4M08	M8 x 30 Ø10	192,640	100	1.600
HEC4M10	M10 x 40 Ø12	297,627	50	800
HEC4M12	M12 x 50 Ø15	563,283	50	400

HE-C4

Con collarín. Inoxidable A4. Homologado ETE Aplicaciones no estructurales



HE

Anclaje hembra con cono interior para grandes cargas

HE-HC

Versión corta. Zincado. Homologado ETE Aplicaciones no estructurales



02 Info. Técnica P. 391

MACIZOS

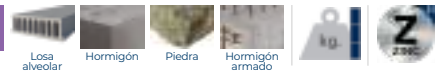

CÓDIGO	MEDIDA	€/100		
HEHCM08	M8 x 25	25,720	100	1.600
HEHCM10	M10 x 25	41,890	50	800
HEHCM12	M12 x 25	75,297	50	800

HE-NO

Zincado



02 Info. Técnica P. 391

MACIZOS



CÓDIGO	MEDIDA	€/100		
HENOM06	M6 x 25 Ø8	14,120	100	4.000
HENOM08	M8 x 30 Ø10	19,500	100	2.200
HENOM10	M10 x 40 Ø12	30,318	50	1.000
HENOM12	M12 x 50 Ø15	55,730	50	600
HENOM16	M16 x 65 Ø20	140,439	25	250
HENOM20	M20 x 80 Ø25	262,849	25	100

HE-NS

ATLANTIS C3-L



02 Info. Técnica P. 391

MACIZOS



CÓDIGO	MEDIDA	€/100		
HENSM08	M8 x 30 Ø10	31,607	100	1.600
HENSM10	M10 x 40 Ø12	49,673	50	800
HENSM12	M12 x 50 Ø15	91,317	50	400
HENSM16	M16 x 65 Ø20	237,017	25	250

HE-HO SDS

Broca SDS con tope para HE-HO



MACIZOS

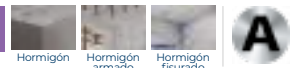

CÓDIGO	MEDIDA	€/PC		
HEHOSDS06	Ø8 x 27	13,419	1	10
HEHOSDS08	Ø10 x 33	15,321	1	10
HEHOSDS10	Ø12 x 43	19,134	1	10
HEHOSDS12	Ø15 x 54	24,863	1	10

HE-HC SDS

Broca SDS con tope para HE-HC



MACIZOS



CÓDIGO	MEDIDA	€/PC		
HEHCSDS08	Ø10 x 28	15,321	1	10
HEHCSDS10	Ø12 x 28	19,134	1	10
HEHCSDS12	Ø15 x 29	24,856	1	10

Anclaje hembra con cono interior para grandes cargas

HE

MACIZOS



CÓDIGO	MEDIDA	€/100		
EXHBM06	M6	1.287,943	1	10
EXHBM08	M8	1.287,943	1	10
EXHBM10	M10	1.287,943	1	10
EXHBM12	M12	1.328,687	1	10
EXHBM16	M16	1.525,233	1	10
EXHBM20	M20	1.712,107	1	10

EXP

Expansionador manual para anclajes hembra HE (excepto HE-HC)



MACIZOS



CÓDIGO	MEDIDA	€/100		
EXHBM08C	M8 (HE-HC)	1.287,943	1	10
EXHBM10C	M10 (HE-HC)	1.287,943	1	10
EXHBM12C	M12 (HE-HC)	1.328,687	1	10

EXP-C

Expansionador manual para anclajes hembra HE-HC



METAL



CÓDIGO	MEDIDA	€/PC		
EXHSDSM06	M6	31,357	1	50
EXHSDSM08	M8	31,357	1	50
EXHSDSM10	M10	31,357	1	50
EXHSDSM12	M12	31,357	1	50

EXP-SDS **NEW**

Expansionador con acople broca SDS para anclajes hembra HE (excepto HE-HC)



METAL



CÓDIGO	MEDIDA	€/PC		
EXHSDSM08C	M8 (HE-HC)	31,357	1	50
EXHSDSM10C	M10 (HE-HC)	31,357	1	50
EXHSDSM12C	M12 (HE-HC)	31,357	1	50

EXP-SDS C **NEW**

Expansionador con acople broca SDS para anclajes hembra HE-HC



Anclaje para losa alveolar. Homologado ETE

HC



HUECOS



CÓDIGO	MEDIDA	€/100	Ø BROCA		
HCM06	M6	67,997	10	100	600
HCM08	M8	80,237	12	50	600
HCM10	M10	114,137	16	25	300



TALA

Taco de latón para fijaciones ligeras en materiales macizos



02 Info. Técnica
P. 392

MACIZOS

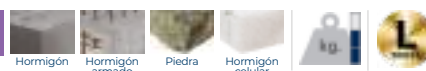

CÓDIGO	MEDIDA	€/100	Ø BROCA		
TALAM04	M4 x 16 Ø5	14,070	5	300	9.600
TALAM05	M5 x 18 Ø6	22,073	6	200	6.400
TALAS32	W5/32 x 16 Ø5	14,070	5	300	9.600
TALAM06	M6 x 23 Ø8	29,547	8	200	4.800
TALAM08	M8 x 28 Ø10	53,043	10	100	2.400
TALAM10	M10 x 33 Ø12	82,867	12	150	1.800
TALAM12	M12 x 38 Ø15	172,843	15	150	900

Blíster

CÓDIGO	MEDIDA	€/BOLSA	PCS	BOLSAS
BZTALAM06	M6 x 23 Ø8	3,377	4	20
BZTALAM08	M8 x 28 Ø10	3,377	4	20
BZTALAM10	M10 x 33 Ø12	3,377	2	15

Caja ventana

CÓDIGO	MEDIDA	€/CAJA	PCS	CAJAS
VTALAM06	M6 x 23 Ø8	8,472	25	8
VTALAM08	M8 x 28 Ø10	8,995	15	8
VTALAM10	M10 x 33 Ø12	14,177	15	8

TA-ME

Taco de expansión metálico



02 Info. Técnica
P. 392

MACIZOS



CÓDIGO	MEDIDA	€/100	Ø BROCA	UD. MIN. VENTA		
TAME05030	M5 x 30 Ø5	14,380	5	200	100	4.500
TAME06032	M6 x 32 Ø6	16,137	6	200	100	2.400
TAME08038	M8 x 38 Ø8	27,043	8	200	100	1.200
TAME08060	M8 x 60 Ø8	37,420	8	100	50	600
TAME10060	M10 x 60 Ø10	43,530	10	50	50	600

AN-CU

Anclaje metálico tipo cuña. Homologado ETE



02 Info. Técnica
P. 392

MACIZOS

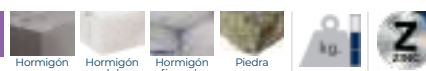

CÓDIGO	MEDIDA	€/100	Ø BROCA		
ANCU06040	6 x 40 Ø6	29,150	6	100	1.200
ANCU06070	6 x 70 Ø6	43,747	6	100	1.200



TC-MA

Taco clavable metálico con punta de acero



METAL

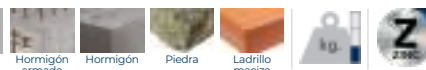

CÓDIGO	MEDIDA	€/100	Ø BROCA		
TCMA05022	5 x 22 Ø5	17,971	5	100	2.400
TCMA06030	6 x 30 Ø6	25,913	6	100	2.400
TCMA06040	6 x 40 Ø6	29,093	6	100	1.200
TCMA06050	6 x 50 Ø6	33,460	6	100	1.200

Anclaje metálico de golpe para aplicaciones no estructurales en hormigón.
Homologado ETE

NA

02
P. 393 Info
Técnica

MACIZOS



CÓDIGO	MEDIDA	€/100		
NAC6035	Ø6 x 35	50,942	100	1.600
NAC6040	Ø6 x 40	52,617	100	1.600
NAC6045	Ø6 x 45	53,763	100	1.600
NAC6050	Ø6 x 50	54,909	100	1.600
NAC6055	Ø6 x 55	56,054	100	1.600
NAC6065	Ø6 x 65	59,818	100	1.200
NAC6085	Ø6 x 85	63,457	100	800
NAC6110	Ø6 x 110	69,531	100	800

NA-C **NEW**

Cabeza plana. Eje zincado. Clip ATLANTIS C3-L



02
P. 393 Info
Técnica

MACIZOS

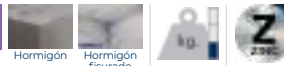

CÓDIGO	MEDIDA	€/100		
NAE6045	Ø6 x 45 (M6)	60,896	100	800
NAE6050	Ø6 x 50 (M6)	61,782	100	800
NAE6055	Ø6 x 55 (M6)	62,610	100	800

NA-E **NEW**

Espárrago. Eje zincado. Clip ATLANTIS C3-L



02
P. 393 Info
Técnica

MACIZOS

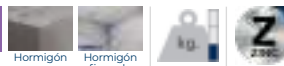

CÓDIGO	MEDIDA	€/100		
NAF65810	Ø6 x 58 (M8+M10)	126,143	50	800
NAF66310	Ø6 x 63 (M8+M10)	127,270	50	800

NA-F **NEW**

Rosca hembra. Eje zincado. Clip ATLANTIS C3-L



02
P. 393 Info
Técnica

MACIZOS

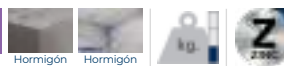

CÓDIGO	MEDIDA	€/100		
NAG6055	Ø6 x 55	85,414	100	1.200

NA-G **NEW**

Gancho. Eje zincado. Clip ATLANTIS C3-L



02
P. 393 Info
Técnica

MACIZOS

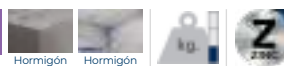

CÓDIGO	MEDIDA	€/100		
NAR6055	Ø6 x 55	86,906	100	1.200

NA-R **NEW**

Argolla. Eje zincado. Clip ATLANTIS C3-L



AC

Anclaje de acero con aletas para cargas altas

AC-CA

Cápsula



02 Info. Técnica
P. 394

MACIZOS

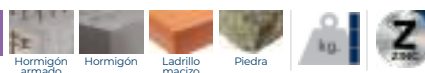

CÓDIGO	MEDIDA	€/100	UD. MIN. VENTA		
AACCA06	M6 x 40 Ø10	34,343	-	50	1.200
AACCA08	M8 x 50 Ø14	52,360	100	50	600
AACCA10	M10 x 60 Ø16	71,543	100	50	300
AACCA12	M12 x 80 Ø20	135,780	50	25	300
AACCA16	M16 x 100 Ø25	356,807	20	10	120

AC-CI

Cápsula. Inoxidable A4



02 Info. Técnica
P. 395

INOXIDABLE

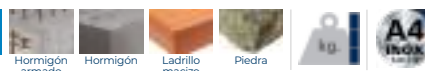

CÓDIGO	MEDIDA	€/100		
AACCI06	M6 x 40 Ø10	406,123	50	1.200
AACCI08	M8 x 50 Ø14	736,383	50	600
AACCI10	M10 x 60 Ø16	850,880	25	300
AACCI12	M12 x 80 Ø20	1.524,433	10	120

AC-TO

Tornillo 6.8



02 Info. Técnica
P. 395

MACIZOS

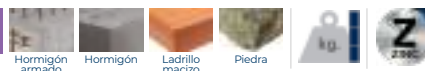

CÓDIGO	MEDIDA	€/100		
AACTO06	M6 x 40 Ø10	52,960	50	600
AACTO08	M8 x 50 Ø14	96,527	50	300
AACTO10	M10 x 60 Ø16	140,377	50	200
AACTO12	M12 x 80 Ø20	282,167	25	100
AACTO16	M16 x 125 Ø25	611,917	10	30

AC-ES

Espárrago



02 Info. Técnica
P. 395

MACIZOS

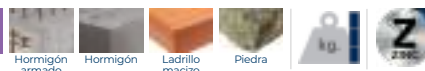

CÓDIGO	MEDIDA	€/100		
AACES06	M6 x 40 Ø10	76,037	50	600
AACES08	M8 x 50 Ø14	115,079	50	300
AACES10	M10 x 60 Ø16	168,180	50	200
AACES12	M12 x 80 Ø20	343,741	25	100

AC-GA

Gancho



02 Info. Técnica
P. 395

MACIZOS

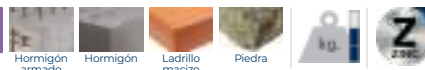

CÓDIGO	MEDIDA	€/100	APERTURA GANCHO		
AACGA06	M6 x 40 Ø10	116,423	10	50	600
AACGA08	M8 x 50 Ø14	162,120	11	50	300
AACGA10	M10 x 60 Ø16	245,667	14	50	100
AACGA12	M12 x 80 Ø20	433,817	18	25	50

AC-AR

Argolla



02 Info. Técnica
P. 395

MACIZOS

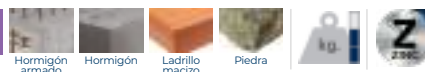

CÓDIGO	MEDIDA	€/100	Ø OJO		
AACAR06	M6 x 40 Ø10	116,423	10	50	600
AACAR08	M8 x 50 Ø14	162,120	12	50	300
AACAR10	M10 x 60 Ø16	245,667	14	50	200
AACAR12	M12 x 80 Ø20	433,817	17	25	100

Anclaje de zamak para cargas medias-altas en materiales macizos o huecos

ZA

02 Info Técnica
p. 393

MACIZOS



CÓDIGO	MEDIDA	€/100		
AZAMC06	M6 x 48 Ø12	134,954	100	1.200
AZAMC08	M8 x 50 Ø14	154,840	100	600
AZAMC10	M10 x 58 Ø16	198,355	50	300
AZAMC12	M12 x 72 Ø20	319,720	25	300
AZAMC16	M16 x 107 Ø25	684,308	25	150

ZA-CA

Cápsula



02 Info Técnica
p. 394

MACIZOS



CÓDIGO	MEDIDA	€/100		
AZAMT06	M6 x 50 Ø12	172,623	100	600
AZAMT08	M8 x 60 Ø14	205,887	100	400
AZAMT10	M10 x 80 Ø16	287,720	50	200
AZAMT12	M12 x 100 Ø20	491,763	25	100
AZAMT16	M16 x 140 Ø25	1.091,367	25	50

ZA-TO

Tornillo



02 Info Técnica
p. 394

MACIZOS



CÓDIGO	MEDIDA	€/100	MEDIDA TORNILLO		
AZAME06	M6 x 60 Ø12	185,301	60	100	600
AZAME08	M8 x 70 Ø14	226,810	70	100	400
AZAME10	M10 x 100 Ø16	325,990	100	50	200
AZAME12	M12 x 120 Ø20	591,787	120	25	100
AZAME16	M16 x 140 Ø25	1.288,889	140	25	50

ZA-ES

Espárrago



02 Info Técnica
p. 394

MACIZOS

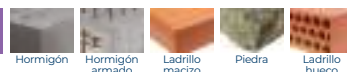

CÓDIGO	MEDIDA	€/100	APERTURA GANCHO		
AZAMG06	M6 x 45 Ø12	164,447	10	50	600
AZAMG08	M8 x 50 Ø14	220,327	13	50	300
AZAMG10	M10 x 56 Ø16	342,181	14	25	150
AZAMG12	M12 x 70 Ø20	542,400	22	25	100

ZA-GA

Gancho



02 Info Técnica
p. 394

MACIZOS



CÓDIGO	MEDIDA	€/100	APERTURA GANCHO		
AZAMGF006	M6 x 45 Ø12	241,447	10	50	600
AZAMGF008	M8 x 50 Ø14	325,700	11	50	300
AZAMGF010	M10 x 56 Ø16	433,103	14	25	150
AZAMGF012	M12 x 70 Ø20	692,887	18	25	75

ZA-GF

Gancho forjado



ZA

Anclaje de zamak para cargas medias-altas en materiales macizos o huecos

ZA-AR

Argolla



MACIZOS



CÓDIGO	MEDIDA	€/100	Ø OJO		
AZAMA06	M6 x 45 Ø12	164,447	10	50	600
AZAMA08	M8 x 50 Ø14	220,327	13	50	300
AZAMA10	M10 x 56 Ø16	342,181	14	25	150
AZAMA12	M12 x 70 Ø20	542,400	22	25	100

ZA-AF

Argolla forjada



MACIZOS



CÓDIGO	MEDIDA	€/100	Ø OJO		
AZAMAF006	M6 x 45 Ø12	241,447	10	50	600
AZAMAF008	M8 x 50 Ø14	325,700	12	50	300
AZAMAF010	M10 x 56 Ø16	433,103	14	25	150
AZAMAF012	M12 x 70 Ø20	692,887	17	25	100

HI

Anclaje antigiro para cargas altas

HI-CA

Cápsula



MACIZOS

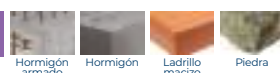

CÓDIGO	MEDIDA	€/100		
AHICA0645	M6 x 45 Ø12	85,160	100	1.200
AHICA0855	M8 x 55 Ø14	93,140	50	600
AHICA1065	M10 x 65 Ø16	119,103	50	300
AHICA1275	M12 x 75 Ø20	159,857	25	150
AHICA1690	M16 x 90 Ø24	333,419	10	60

HI-CI

Cápsula. Inoxidable A2



INOXIDABLE

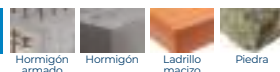

CÓDIGO	MEDIDA	€/100		
AHIC10645	M6 x 45 Ø12	642,275	100	600
AHIC10855	M8 x 55 Ø14	800,887	50	600
AHIC11065	M10 x 65 Ø16	1.069,243	50	300

HI-TO

Tornillo 8.8



MACIZOS

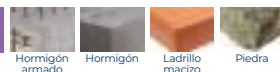

CÓDIGO	MEDIDA	€/100		
AHIT00645	M6 x 45 Ø12	113,317	100	600
AHIT00855	M8 x 55 Ø14	139,377	50	300
AHIT01065	M10 x 65 Ø16	196,970	50	200
AHIT01275	M12 x 75 Ø20	299,860	25	100
AHIT01690	M16 x 90 Ø24	555,890	10	40

Anclaje antigiro para cargas altas

HI



MACIZOS

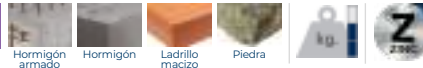

CÓDIGO	MEDIDA	€/100	APERTURA GANCHO		
AHIGA0645	M6 x 45 Ø12	163,680	10	100	400
AHIGA0855	M8 x 55 Ø14	227,317	11	50	300
AHIGA1065	M10 x 65 Ø16	337,030	14	50	100
AHIGA1275	M12 x 75 Ø20	523,377	18	25	75
AHIGA1690	M16 x 90 Ø24	1.019,340	19	10	30

HI-GA

Gancho



MACIZOS

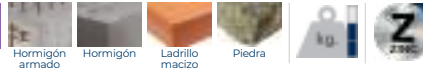

CÓDIGO	MEDIDA	€/100	Ø OJO		
AHIAR0645	M6 x 45 Ø12	166,968	10	100	400
AHIAR0855	M8 x 55 Ø14	210,448	12	50	300
AHIAR1065	M10 x 65 Ø16	289,030	14	50	200
AHIAR1275	M12 x 75 Ø20	487,167	17	25	75
AHIAR1690	M16 x 90 Ø24	1.062,121	23	10	30

HI-AR

Argolla



Anclaje metálico para fijar marcos de puertas y ventanas

EPS



MULTIMATERIAL

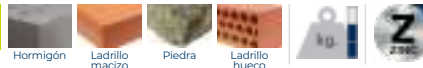

CÓDIGO	ØBROCA X LONGITUD	€/100		ESPESOR MÁX. A FIJAR (MM)		
EPS6072	M6 x 72 Ø10	64,927	PZ3	40	100	600
EPS6092	M6 x 92 Ø10	78,543	PZ3	60	100	600
EPS6112	M6 x 112 Ø10	86,453	PZ3	80	100	200
EPS6132	M6 x 132 Ø10	97,117	PZ3	100	100	200
EPS6152	M6 x 152 Ø10	110,097	PZ3	120	100	400
EPS6182	M6 x 182 Ø10	139,867	PZ3	150	100	300



Taco elástico para la fijación de rastreles

TRA



MACIZOS



CÓDIGO	ØBROCA X LONGITUD	€/100	ESPESOR MÁX. A FIJAR (MM)		
TRA6050	6 x 50 Ø6	18,413	20	200	2.400
TRA6060	6 x 60 Ø6	19,203	30	200	1.200
TRA6080	6 x 80 Ø6	22,043	50	200	1.200
TRA8070	8 x 70 Ø8	30,270	30	100	1.200
TRA8090	8 x 90 Ø8	36,143	50	100	600
TRA8110	8 x 110 Ø8	42,760	70	100	600
TRA8130	8 x 130 Ø8	53,510	90	100	600
TRA8150	8 x 150 Ø8	59,993	110	100	600



AV

Anclaje para fachadas ventiladas

AVR

Roscado



INOXIDABLE

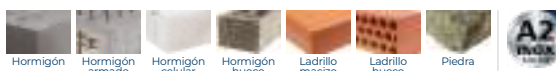

CÓDIGO	MEDIDA	€/100		
AVR08120	M8 x 120 Ø8	293,609	100	600
AVR08150	M8 x 150 Ø8	318,543	100	600
AVR10120	M10 x 120 Ø10	359,184	100	400
AVR10150	M10 x 150 Ø10	411,042	100	200
AVR10180	M10 x 180 Ø10	457,326	100	200

AVC

Corrugado



INOXIDABLE

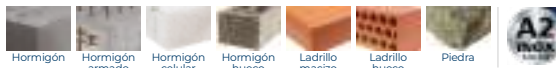

CÓDIGO	MEDIDA	€/100		
AVC08120	8 x 120 Ø8	403,750	100	400
AVC08150	8 x 150 Ø8	460,750	100	-
AVC10120	10 x 120 Ø10	566,103	100	400
AVC10150	10 x 150 Ø10	648,407	100	200
AVC10180	10 x 180 Ø10	732,023	100	200

ANFA

Anclaje para andamios y fachadas

AN-23

Diámetro de ojo 23 mm



02 P. 397 Info. Técnica

MULTIMATERIAL

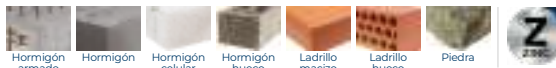

CÓDIGO	MEDIDA	€/100	Ø TACO	PROFUNDIDAD DE TALADRO	PROFUNDIDAD MÍN. DEL ANCLAJE	Ø OJO		
ANFA2309	12 x 90 Ø14-Ø16	187,690	90	90	100	23	20	120
ANFA2312	12 x 120 Ø14-Ø16	196,779	120	120	130	23	20	80
ANFA2316	12 x 160 Ø14-Ø16	238,495	160	160	170	23	20	60
ANFA2319	12 x 190 Ø14-Ø16	273,877	190	190	200	23	20	60
ANFA2323	12 x 230 Ø14-Ø16	315,457	230	230	240	23	20	40
ANFA2330	12 x 300 Ø14-Ø16	428,210	300	300	310	23	10	20
ANFA2335	12 x 350 Ø14-Ø16	490,649	350	350	360	23	10	-

AN-51

Diámetro de ojo 51 mm



02 P. 397 Info. Técnica

MULTIMATERIAL

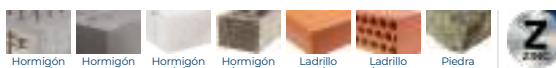

CÓDIGO	MEDIDA	€/100	Ø TACO	PROFUNDIDAD DE TALADRO	PROFUNDIDAD MÍN. DEL ANCLAJE	Ø OJO		
ANFA5114	12 x 140 Ø14-Ø16	329,933	140	140	150	51	20	60
ANFA5116	12 x 160 Ø14-Ø16	360,174	160	160	170	51	20	40
ANFA5120	12 x 200 Ø14-Ø16	466,483	200	200	210	51	20	40
ANFA5124	12 x 240 Ø14-Ø16	513,867	240	240	250	51	20	40

AN-50 CT

Diámetro de ojo 50 mm + cápsula Zamak M10



02 P. 397 Info. Técnica

MULTIMATERIAL

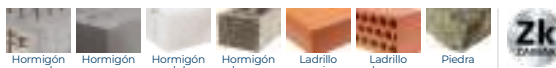

CÓDIGO	MEDIDA	€/100	Ø TACO	PROFUNDIDAD DE TALADRO	PROFUNDIDAD MÍN. DEL ANCLAJE	Ø OJO		
ANFA5021	M10 x 210 Ø16	1.201,092	210	55	120	50	10	20

Anclaje para andamios y fachadas

ANFA

MULTIMATERIAL



CÓDIGO	MEDIDA	€/100		
TCSO14075	14 x 75 Ø14	26,553	20	240
TCSO14100	14 x 100 Ø14	33,514	20	240

TC-SO 2

Taco de nylon. 2 alas



MULTIMATERIAL



CÓDIGO	MEDIDA	€/100		
TCSO14130	14 x 130 Ø14	62,521	20	240
TCSO14160	14 x 160 Ø14	70,435	20	120
TCSO16140	16 x 140 Ø16	137,953	20	120
TCSO16160	16 x 160 Ø16	150,057	20	80
TCSO16200	16 x 200 Ø16	154,930	20	60
TCSO16240	16 x 240 Ø16	172,434	20	40

TC-SO 8

Taco de nylon. 8 alas



MULTIMATERIAL



CÓDIGO	MEDIDA	€/100	Ø TACO	PROFUNDIDAD MÍN. DE TALADRO	PROFUNDIDAD MÍN. DEL ANCLAJE		
ANFATA37B	13 x 37	27,027	37	33	130	100	600
ANFATA70B	13 x 70	33,859	70	33	180	100	300

AN-TA

Tapón tapa-agujeros





FIJACIONES QUÍMICAS



Tabla de selección



MO-PU	MO-PUP	MO-PSU	MO-P+	MO-PS+	MO-PSP+	MO-V	MO-VSF	MO-VH	MO-VHW	MOPURE	MOPUR3
Polyester Universal	Polyester Universal Piedra	Styrene free Universal Polyester	Polyester PLUS	Polyester PLUS sin estireno	Polyester PLUS sin estireno. Piedra	Vinylester	Vinylester sin estireno	Vinilester hibrido sin estireno	Vinilester hibrido sin estireno. WINTER	Epoxy puro 1:1	Epoxy puro 3:1

									•	•	•	•
	•	•	•	•	•	•	•					
							•	•		•	•	
			•		•	•	•					
								•	•			•
										•		
	•	•	•	•	•	•	•	•	•	•	•	•
	•	•	•	•	•	•	•	•	•	•	•	•
			•		•	•		•	•	•		
	•	•	•	•	•	•	•	•	•	•	•	•
	•	•	•	•	•	•	•	•	•	•	•	•
	•	•	•	•	•	•	•	•	•	•	•	•
	•	•	•	•	•	•	•	•	•	•	•	•
	•	•	•	•	•	•	•	•	•	•	•	•
	•	•	•	•	•	•	•	•	•	•	•	•
	•	•	•	•	•	•	•	•	•	•	•	•
									•			
	•	•	•	•	•	•	•	•	•	•	•	•

Fijaciones químicas

MO

02 Info
P. 400 Técnica

QUÍMICOS

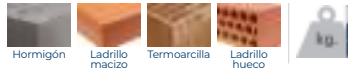

CÓDIGO	MEDIDA	€/PC	PCS. X BOTE	
MOPU300	300 ml.	13,987	1	12
MOPU410	410 ml.	16,912	1	12



MO-PU

Polyester universal. Homologado ETE Opt.7



02 Info
P. 400 Técnica

QUÍMICOS

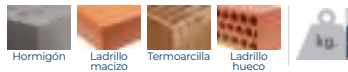

CÓDIGO	MEDIDA	€/PC	PCS. X BOTE	
MOPUP300	300 ml.	14,683	1	12





MO-PUP ^{NEW}

Polyester universal color piedra. Homologado ETE Opt.7

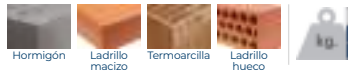

QUÍMICOS



CÓDIGO	MEDIDA	€/PC	PCS. X BOTE	
MOPSU300	300 ml.	14,432	1	12
MOPSU410	410 ml.	19,757	1	12



MO-PSU ^{NEW}

Polyester universal sin estireno. Homologado



02 Info
P. 400 Técnica

QUÍMICOS

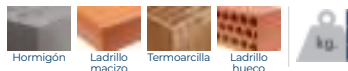

CÓDIGO	MEDIDA	€/PC	PCS. X BOTE	
MOP300	300 ml.	15,188	1	12
MOP410	410 ml.	17,943	1	12



MO-P+

Polyester PLUS. Homologado ETE Opt.7



MO

Fijaciones químicas

MO-PS+

Polyester PLUS sin estireno con testigo de manipulado. Homologado ETE Opt.7



02 Info. Técnica
P. 400

QUÍMICOS

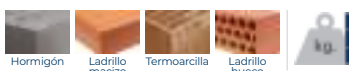

CÓDIGO	MEDIDA	€/PC	PCS. X BOTE	
MOPS300	300 ml.	17,397	1	12
MOPS410	410 ml.	21,486	1	12
KIT MO-PS+				
MOPS300EP	300 ml.	28,873		1

- Contenido del KIT:
- Cartucho MOPS300 (300 ml.) - x1
 - Cánulas MORCANU x2
 - Espárragos MOES08110 (M8 x 110 Ø8) - x4
 - Tamicas Nylon MOTN15085 (15 x 85) - x4

Ver vídeo



¿Sabes hasta cuándo se puede manipular un anclaje químico ya aplicado?

El novedoso TESTIGO DE MANIPULADO incorporado en el MO-PS+ se trata de una tecnología única en el mercado. La resina cambia de color cuando inicia el proceso de curado, de azul a gris. Mientras se mantiene el tono azulado, el espárrago o varilla aplicada se puede manipular.



MO-PSP+

Polyester PLUS sin estireno color piedra. Homologado ETE Opt.7



02 Info. Técnica
P. 400

QUÍMICOS

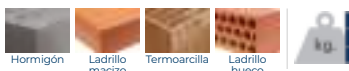

CÓDIGO	MEDIDA	€/PC	PCS. X BOTE	
MOPSP300	300 ml.	18,268	1	12
MOPSP410	410 ml.	22,560	1	12



M8-M24

MO-V

Vinylester. Homologado ETE Opt.7.



02 Info. Técnica
P. 400

QUÍMICOS

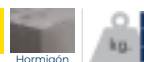

CÓDIGO	MEDIDA	€/PC	PCS. X BOTE	
MOV300	300 ml.	19,427	1	12
MOV410	410 ml.	22,134	1	12



NEW MO-VSF

Vinylester sin estireno. Homologado



QUÍMICOS

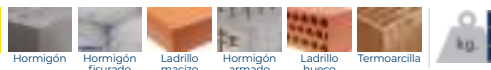

CÓDIGO	MEDIDA	€/PC	PCS. X BOTE	
MOVSF300	300ml.	16,767	1	12
MOVSF410	410ml.	18,896	1	12



Fijaciones químicas

MO

QUÍMICOS



CÓDIGO	MEDIDA	€/PC	PCS. X BOTE	
MOVH300	300 ml.	28,514	1	12
MOVH410	410 ml.	34,105	1	12



MO-VH NEW

Vinilester híbrido de altas prestaciones sin estireno. Homologado



QUÍMICOS



CÓDIGO	MEDIDA	€/PC	PCS. X BOTE	
MOVHW300	300ml.	29,939	1	12
MOVHW410	410ml.	35,810	1	12



MO-VHW NEW

Vinilester híbrido de altas prestaciones sin estireno versión WINTER. Homologado



02 Info. Técnica P. 400

QUÍMICOS



CÓDIGO	MEDIDA	€/PC	PCS. X BOTE	
MOPURE600	600 ml.	71,442	1	12



MOPURE

Epoxy Puro 1:1. Homologado ETE Opt.1



02 Info. Técnica P. 400

QUÍMICOS



CÓDIGO	MEDIDA	€/PC	PCS. X BOTE	
MOPUR30385	385 ml.	55,803	1	12
MOPUR30585	585 ml.	74,730	1	12



MOPUR3

Epoxy puro 3:1. Homologado ETE Opt.1



MO-PIS

Pistolas aplicadoras

MO-PIS

Pistolas aplicadoras



MOPISTO



MOPISPR



MOPISSI



MOPISPUR6



MOPISNEU



MOPISP3

CÓDIGO	MEDIDA	€/PC	
MOPISTO	Manual / Manuel 410 ml.	55,209	1
MOPISPR	Profesional / Professional / Professionnel 410 ml.	125,046	1
MOPISSI	Silicona / Silicone/ 300 ml.	33,382	1
MOPISPUR6	MOPURE600 - 600 ml.	77,569	1
MOPISNEU	Neumática / Pneumatic / Pneumatique	1.671,813	1
MOPISP3385	MOPUR3 - 385 ml.	146,232	1
MOPISP3585	MOPUR3 - 585 ml.	166,064	1

MO-TN

Tamiz de plástico



CÓDIGO	MEDIDA	€/100	UD. MIN. VENTA		
MOTN12050	12 x 50	30,439	24	12	1.728
MOTN12080	12 x 80	31,334	24	12	1.536
MOTN15085	15 x 85	32,673	24	12	864
MOTN15130	15 x 130	38,540	24	12	600
MOTN20085	20 x 85	37,180	24	12	600

MO-TR

Tamiz roscado



CÓDIGO	MEDIDA	€/100		
MOTRO08	M8 x 80 Ø12	180,437	12	540
MOTRO10	M10 x 80 Ø14	241,720	12	288
MOTRO12	M12 x 80 Ø16	292,667	12	288

MO-AC

Cánulas mezcladoras y varios



MOBOMBA
Bomba sopladora



MORCAPU
Cánula mezcladora (385-585-600 ml)



MORCEPKIT
Kit de 3 cepillos



MO-TL
Tamiz largo recortable para fijación en cubierta teja + rasillón



MORCANU
Cánula mezcladora (300-410 ml)



MO-PC
Extensor de cánula para fijaciones químicas

CÓDIGO	MEDIDA	€/PC		
MOBOMBA	Bomba Sopladora	18,939	1	
MORCANU	170 ml. - 300 ml. - 410 ml.	0,922	10	1.000
MORCAPU	Cánula/ Nozzle/ Canule/ Cànula (385-585-600 ml)	2,564	12	24
MORCEPKIT	Kit Cepillo / Brush / Écouvillon (1 x Ø14 - 1 x Ø20 - 1 x Ø27)	74,443	1	
MOTL16330	16 x 330	178,637	10	500
MOPC185	185 mm	3,587	1	20

MO-ES

Espárrago roscado



CÓDIGO	MEDIDA	€/100		
MOES06070	M6 x 70 Ø6	73,384	12	540
MOES08110	M8 x 110 Ø8	124,196	12	288
MOES10115	M10 x 115 Ø10	169,296	12	144
MOES12110	M12 x 110 Ø12	219,78	12	144

Bolsa autoservicio

CÓDIGO	MEDIDA	€/BOLSA	PCS	BOLSAS
LSMOES06070	M6 x 70 Ø6	4,070	4	10
LSMOES08110	M8 x 110 Ø8	5,805	4	7
LSMOES10115	M10 x 115 Ø10	7,163	4	6
LSMOES12110	M12 x 110 Ø12	8,997	4	6

MO-TM

Tamiz metálico



CÓDIGO	MEDIDA	€/100	
MOTM12100	12 x 1000 Ø11	2.096,798	10
MOTM16100	16 x 1000 Ø14	2.374,498	10
MOTM22100	22 x 1000 Ø21	2.709,351	5

Resina de epoxi-acrilato, cuarzo y catalizador. Homologado ETE Opt. 8

CA-QU



QUÍMICOS

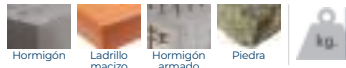

CÓDIGO	MEDIDA	€/100		
CAQU008	8 x 80 Ø10	217,629	10	500
CAQU010	10 x 90 Ø12	222,631	10	500
CAQU012	12 x 110 Ø14	232,124	10	200
CAQU016	16 x 125 Ø18	258,073	10	200

CÓDIGO	MEDIDA	€/100		
CAQU020	20 x 170 Ø25	509,803	6	60
CAQU024	24 x 210 Ø28	596,893	6	60
• CAQU030	30 x 280 Ø35	1.138,887	6	30

• Medidas sin homologar





Espárragos con tuerca y arandela para anclaje químico

EQ

QUÍMICOS



CÓDIGO	MEDIDA	€/100		
EQAC08110	M8 x 110	112,96	10	240
EQAC10130	M10 x 130	174,608	10	120
EQAC10190	M10 x 190	265,080	10	40
EQAC12160	M12 x 160	264,828	10	120
EQAC12220	M12 x 220	408,844	10	30
EQAC16190	M16 x 190	521,684	10	40
EQAC16250	M16 x 250	737,664	10	30
EQAC20260	M20 x 260	1.149,104	6	12
EQAC20350	M20 x 350	1.622,136	6	-
EQAC24300	M24 x 300	1.746,472	6	12
EQAC24380	M24 x 380	2.709,288	6	-
EQAC30330	M30 x 330	3.169,180	6	12



EQ-AC

Zincado



QUÍMICOS



CÓDIGO	MEDIDA	€/100		
EQ8808110	M8 x 110	118,608	10	240
EQ8810130	M10 x 130	186,832	10	120
EQ8812160	M12 x 160	283,364	10	60
EQ8816190	M16 x 190	560,812	6	24
EQ8820260	M20 x 260	1.206,560	6	24
EQ8824300	M24 x 300	1.886,192	6	12



EQ-8.8

Zincado 8.8



QUÍMICOS



CÓDIGO	MEDIDA	€/100		
EQA208110	M8 x 110	252,930	10	240
EQA210130	M10 x 130	439,997	10	120
EQA212160	M12 x 160	729,210	10	120
EQA216190	M16 x 190	1.510,907	10	40
EQA220260	M20 x 260	2.887,737	6	12
EQA224300	M24 x 300	4.614,763	6	12

CÓDIGO	MEDIDA	€/100		
EQA230330	M30 x 330	7.745,917	6	12



EQ-A2

Inoxidable A2



QUÍMICOS



CÓDIGO	MEDIDA	€/100		
EQA408110	M8 x 110	338,743	10	240
EQA410130	M10 x 130	615,293	10	120
EQA412160	M12 x 160	1.058,413	10	120
EQA416190	M16 x 190	2.073,420	10	40

CÓDIGO	MEDIDA	€/100		
EQA420260	M20 x 260	5.048,270	6	12
EQA424300	M24 x 300	8.320,540	6	12
EQA430330	M30 x 330	15.411,365	6	12

EQ-A4

Inoxidable A4



Tabla de selección



	MSPRB290	MSPRG290	MSPRM290	MSPRN290	MSTR290	MSSF290
	•	•	•	•		
	•	•	•	•		•
	•	•	•	•	•	•
	•	•	•	•	•	•
	•	•	•	•		
	•	•	•	•	•	•
	•	•	•	•	•	•
	•	•	•	•	•	•
	•	•	•	•	•	•
	•	•	•	•	•	•
	•	•	•	•	•	•
	•	•	•	•	•	•
	•	•	•	•	•	•
	•	•	•	•	•	•
	300 %	300 %	300 %	300 %	250 %	200 %
	150 kg/10 cm ²	150 kg/10 cm ²	150 kg/10 cm ²	150 kg/10 cm ²	140 kg/10 cm ²	430 kg/10 cm ²
	•	•	•	•	•	•
	•	•	•	•	•	•
	•	•	•	•	•	•
					•	
						•

Adhesivos Hybrid MS Polymer

MS

QUÍMICOS

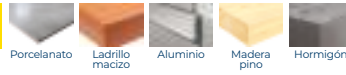

CÓDIGO	MEDIDA	COLOR	€/PC	
MSPRB290	290 ml. (Blanco)	BLANCO	11,474	12
MSPRG290	290 ml. (Gris)	GRIS	11,474	12
MSPRM290	290 ml. (Marrón)	MARRÓN	11,474	12
MSPRN290	290 ml. (Negro)	NEGRO	11,474	12

APLICACIONES

- Pegado y sellado en construcción: repisas, remates en tejado, canalones, cubiertas, juntas de marcos o estructuras sometidas a vibraciones. Sellado y pegado en industria y automóvil.
- Relleno de grietas.
- Sellado de juntas de dilatación, cisternas, contenedores y otros elementos de aluminio.
- Producto certificado para el uso en la industria de procesamiento de alimentos (Certificado ISEGA).
- Adhesión a todo tipo de materiales: hormigón, madera, metal, corcho, aluminio, PVC, cobre, ladrillo, piedra, porcelana... No recomendado para Polietileno (PE), Polipropileno (PP) y Politetrafluoroetileno (PTFE).
- En caso de no conocer el material base se deberán realizar unas pruebas previas para garantizar el buen funcionamiento del producto.

QUÍMICOS



CÓDIGO	MEDIDA	COLOR	€/PC	
MSTR290	290 ml. (Transparente)	TRANSPARENTE	16,969	12

APLICACIONES

- Incoloro. Adecuado para el pegado de vidrio, cristal, acrílico, PVC, porcelana, cerámica y otros elementos transparentes en interior o exterior.
- Fijación de materiales con una unión transparente o visible.
- Apto para aplicación sobre superficies húmedas.
- Adhesión a todo tipo de materiales (hormigón, madera, metal, corcho, aluminio, PVC, cobre, ladrillo, piedra, porcelana...). No recomendado para Polietileno (PE), Polipropileno (PP) y Politetrafluoroetileno (PTFE).
- En caso de no conocer el material base se deberán realizar unas pruebas previas para garantizar el buen funcionamiento del producto.
- Apto para montar y pegar.

QUÍMICOS

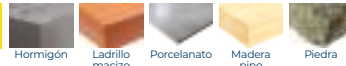



CÓDIGO	MEDIDA	COLOR	€/PC	
MSSF290	290 ml. (Blanco)	BLANCO	12,852	12

APLICACIONES

- Especialmente indicado para el pegado y conexión rápida de elementos pesados sin fijaciones adicionales. Triplica las prestaciones de agarre de otros adhesivos.
- Apto para usar en interior y exterior. Resistente a rayos UV.
- Adhesión a todo tipo de materiales: hormigón, madera, metal, corcho, aluminio, PVC, cobre, ladrillo, piedra, porcelana... No recomendado para Polietileno (PE), Polipropileno (PP) y Politetrafluoroetileno (PTFE).
- En caso de no conocer el material base se deberán realizar unas pruebas previas para garantizar el buen funcionamiento del producto.

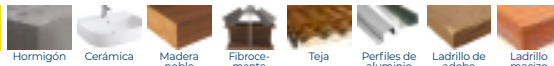
QUÍMICOS



CÓDIGO	MEDIDA	COLOR	€/PC		
MSISG01	1 kg. (Gris)	GRIS	37,623	1	6
MSISG05	5 kg. (Gris)	GRIS	152,473	1	6
MSIST01	1 kg. (Terracota)	TERRACOTA	37,623	1	6
MSIST05	5 kg. (Terracota)	TERRACOTA	152,473	1	6

MS-PR

Adhesivo MS Profesional



MS-TR

Adhesivo MS Transparente



MS-SF

Adhesivo MS Superfast High Tack



MS-IS **NEW**

Membrana impermeabilizante híbrida líquida multiusos de alta elasticidad, basada en tecnología W-PROTEK



Tabla de selección

	SI-PR					SI-PRS		SI-UNI					SI-UNS		SE-ACR	
	SIPRB280	SIPRG280	SIPRM280	SIPRN280	SIPRT280	SIPRSB280	SIPRST280	SIUNIB280	SIUNIG280	SIUNIM280	SIUNIN280	SIUNIT280	SIUNSB280	SIUNST280	SEACRB280	SEACRG280
	•	•	•	•	•	•	•	•	•	•	•	•	•	•	•	•
	•	•	•	•	•	•	•							•	•	
							•	•	•	•	•	•	•			
	•	•	•	•	•	•	•	•	•	•	•	•	•	•	•	•
	•	•	•	•	•	•	•	•	•	•	•	•	•	•	•	•
	•	•	•	•	•	•	•	•	•	•	•	•	•	•	•	•
	•	•	•	•	•	•	•	•	•	•	•	•	•	•	•	•
	•	•	•	•	•	•	•	•	•	•	•	•	•	•	•	•
															•	•
	•	•	•	•	•	•	•	•	•	•	•	•	•	•	•	•
	•	•	•	•	•	•	•							•	•	
	•	•	•	•	•	•	•	•	•	•	•	•	•	•	•	•
	•	•	•	•	•	•	•	•	•	•	•	•	•	•		
					•		•					•		•		
							•	•				•	•			
							•	•				•	•			
	•	•	•	•	•											
	•	•	•	•	•	•	•									
															•	•
															•	•

QUÍMICOS



CÓDIGO	MEDIDA	COLOR	€/PC	
SIPRB280	280 ml. (Blanco)	BLANCO	9,833	12
SIPRG280	280 ml. (Gris)	GRIS	9,833	12
SIPRM280	280 ml. (Marrón)	MARRÓN	9,833	12
SIPRN280	280 ml. (Negro)	NEGRO	9,833	12
SIPRT280	280 ml. (Transparente)	TRANSPARENTE	9,833	12

CARACTERÍSTICAS

- Elásticas y flexibles
- Apto para aplicación en ventanas
- Disponible en colores blanco, negro, marrón (RAL 8016), gris (RAL 7030) y transparente
- Multimaterial: aptas para su uso en carpintería de aluminio y PVC, juntas de dilatación, hormigón, ladrillos, piedra, madera, metales y vidrio)
- Certificado A+ sobre emisiones en interiores

SI-PR

Silicona Neutra Profesional para materiales lisos y porosos



QUÍMICOS

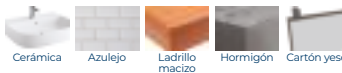

CÓDIGO	MEDIDA	COLOR	€/PC	
SIPRSB280	280 ml. (Blanco)	BLANCO	9,833	12
SIPRT280	280 ml. (Transparente)	TRANSPARENTE	9,833	12

CARACTERÍSTICAS

- Contienen fungicidas para evitar la aparición de moho
- Aptas para la aplicación en baños y cocinas
- Elásticas y flexibles
- Aptas para la aplicación en ventanas
- Disponible en color blanco y transparente
- Multimaterial: aptas para su uso en carpintería de aluminio y PVC, juntas de dilatación, hormigón, ladrillos, piedra, madera, metales y vidrio)

SI-PRS

Silicona Neutra SANITAR Profesional con propiedades fungicidas



QUÍMICOS



CÓDIGO	MEDIDA	COLOR	€/PC	
SIUNIB280	280 ml. (Blanco)	BLANCO	7,035	12
SIUNIG280	280 ml. (Gris)	GRIS	7,035	12
SIUNIT280	280 ml. (Transparente)	TRANSPARENTE	7,035	12

CARACTERÍSTICAS

- Multiusos: apto para su uso en aluminio, cerámica, vidrio y porcelana
- No aptas para materiales porosos, oxidables o atacables por ácidos
- Elásticas y flexibles
- Apto para aplicación en interior y exterior

SI-UNI

Silicona acética universal multiusos



SI

Siliconas

SI-UNS

Silicona acética SANITAR universal multiusos con propiedades fungicidas



SE-ACR

Masilla acrílica para juntas y grietas



MS-CA

Cánulas para MS y Siliconas

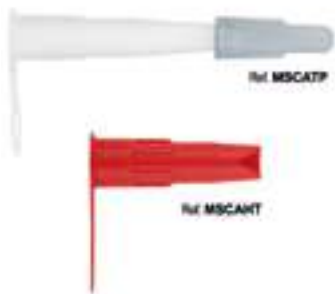

QUÍMICOS



CÓDIGO	MEDIDA	COLOR	€/PC	
SIUNSB280	280 ml. (Blanco)	BLANCO	7,035	12
SIUNST280	280 ml. (Transparente)	TRANSPARENTE	7,035	12

CARACTERÍSTICAS

- Contienen fungicidas para evitar la aparición de moho
- Aptas para la aplicación en baños y cocinas
- Elásticas y flexibles
- Aptas para la aplicación en ventanas
- Disponible en color blanco y transparente
- Multiusos: Aptas para su uso en aluminio, cerámica, vidrio y porcelana.
- No aptas para materiales porosos, oxidables o atacables por ácidos

QUÍMICOS

CÓDIGO	MEDIDA	COLOR	€/PC	
SEACRB280	280 ml. (Blanco)	BLANCO	4,822	12
SEACRG280	280 ml. (Gris)	GRIS	4,822	12

CARACTERÍSTICAS

- Apta para el sellado de todo tipo de juntas, pequeños agujeros, grietas en fachada, pared, ranuras en cajas de persianas, marcos de puertas y ventanas
- Apta para aplicación en materiales porosos (Hormigón, madera, baldosas de cerámica, placas de yeso) y para la reparación de pequeñas grietas
- Flexible y alta adherencia
- Se puede pintar y barnizar
- Muy fácil de aplicar
- Apto para aplicación en interior y exterior

QUÍMICOS

CÓDIGO	MEDIDA	€/BOLSA		
MSCAHT	Ancha	13,273	1	18
MSCATP	Tapón	12,667	1	18

Espumas de poliuretano

PU

QUÍMICOS



CÓDIGO	MEDIDA	€/PC	PCS. X BOTE	
PUSP750	750 ml.	13,710	1	12



PU-SP

Espuma de poliuretano multiusos para aplicación con pistola



QUÍMICOS



CÓDIGO	MEDIDA	€/PC	PCS. X BOTE	
PUSC750	750 ml.	13,050	1	12



CÁNULA ECOFLEX

Su novedoso sistema de bloqueo permite conservar y reutilizar el producto varios días, permitiendo no desperdiciar producto y ser más respetuoso con el medioambiente.

PU-SC

Espuma de poliuretano multiusos para aplicación con cánula ECOFLEX



QUÍMICOS



CÓDIGO	MEDIDA	€/PC	PCS. X BOTE	
PUTP750	750 ml.	15,264	1	12



PU-TP

Espuma de poliuretano para aplicación con pistola. Color gris



PU

Espumas de poliuretano

PU-TPR

Espuma de poliuretano para fijación de tejas para aplicación con pistola. Color teja



QUÍMICOS



CÓDIGO	MEDIDA	€/PC	PCS. X BOTE	
PUTPR750	750 ml.	15,264	1	12



PU-FP

Espuma de poliuretano resistente al fuego para aplicación con pistola



QUÍMICOS



CÓDIGO	MEDIDA	€/PC	PCS. X BOTE	
PUFP750	750 ml.	23,750	1	12



PU-FC

Espuma de poliuretano resistente al fuego para aplicación con cánula ECOFLEX



QUÍMICOS



CÓDIGO	MEDIDA	€/PC	PCS. X BOTE	
PUFC750	750 ml.	22,959	1	12



CÁNULA ECOFLEX

Su novedoso sistema de bloqueo permite conservar y reutilizar el producto varios días, permitiendo no desperdiciar producto y ser más respetuoso con el medioambiente.

Espumas de poliuretano

PU

QUÍMICOS



CÓDIGO	MEDIDA	€/PC	PCS. X BOTE	
PUEP750	750 ml.	20,995	1	12



PU-EP

Adhesivo de poliuretano SATE para paneles aislantes y placas de yeso laminado para aplicación con pistola



QUÍMICOS

CÓDIGO	MEDIDA	€/PC	PCS. X BOTE	
PUCL500	500 ml.	13,660	1	12

PU-CL

Limpiador de accesorios para la aplicación de espuma de poliuretano



PU-PI

Pistolas aplicadoras para espuma de poliuretano

QUÍMICOS

PU-PI

Profesional



CÓDIGO	MEDIDA	€/PC		
PUPI01	750 ml.	91,333	1	12

PU-PI 2

Básica



QUÍMICOS

CÓDIGO	MEDIDA	€/PC		
PUPI02	750 ml.	34,833	1	12

PU-CA

Cánula aplicadora para espuma de poliuretano

QUÍMICOS



CÓDIGO	MEDIDA	€/PC	PCS. X BOTE		
PUCA01	750 ml.	4,924	12	1	18



FIJACIONES PLÁSTICAS



T-NUX

Los tacos de nylon universales de alto rendimiento para uso en hormigón y mampostería, son una solución polivalente y profesional. Permiten su instalación con las máximas garantías de seguridad gracias a que cuentan con homologación ETE y a resistencia a fuego.

Su diseño permite que el taco logre adaptarse a cualquier tipo de material base, ya sea en material sólido o hueco. Además, posibilita que la carga se distribuya a lo largo de todo el taco, gracias a una expansión controlada en distintos puntos del material donde se instala.



DISEÑO Y GEOMETRÍA

Collarín de seguridad.
Impide que el taco se cuele por el taladro

Aletas antigiro. Evitan que el anclaje rote sobre sí mismo en el interior del taladro, aportando seguridad adicional a la instalación

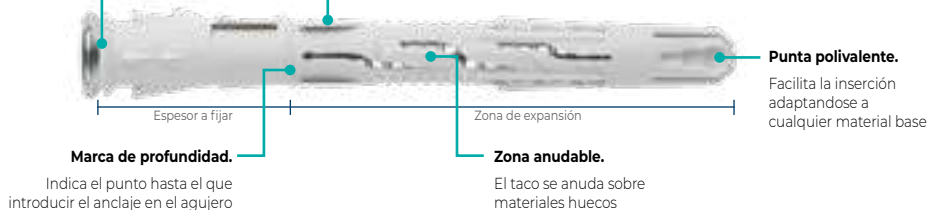

Punta polivalente.

Facilita la inserción adaptándose a cualquier material base

Marca de profundidad.

Indica el punto hasta el que introducir el anclaje en el agujero

Zona anudable.

El taco se anuda sobre materiales huecos

CUALIDADES Y VENTAJAS



MÁXIMA VERSATILIDAD. MULTIMATERIAL.

Su diseño permite que el taco logre adaptarse a cualquier tipo de material base, ya sea en materiales macizos o huecos. Especialmente apto para cuando se desconozca el material base donde se realiza la fijación.

MÁXIMAS GARANTÍAS. PRODUCTOS HOMOLOGADOS ACORDE A LOS MÁS ALTOS ESTÁNDARES DE CALIDAD.

- Homologado (ETA 14/0467) para usos no estructurales en hormigón, hormigón aireado, ladrillo macizo, ladrillo hueco y bloque de hormigón (en las medidas Ø8 y Ø10)
- Homologado a resistencia a fuego R30-R120 en hormigón

*El anclaje está homologado cuando se utiliza el taco y el tornillo en su conjunto, no por separado. Utilizar anclajes homologados aporta seguridad y calidad al anclaje cumpliendo los más altos estándares de calidad.



APLICACIONES



- Fijación de marcos de ventanas y puertas.
- Puertas de garajes.
- Barandillas.
- Balaustradas.
- Fijación de rejillas.
- Rehabilitación de fachadas.
- Fijación de subestructuras metálicas para fachadas ventiladas.
- Usos exteriores e interiores.
- Fijación de aplacados de piedra para revestimientos de fachada.

FABRICACIÓN 100% INDEX

Esto nos permite asegurar un riguroso control de los procesos, garantizar la máxima calidad en nuestros productos, brindar el mejor servicio y obtener un coste global competitivo.



PRODUCTO DE CALIDAD

El anclaje T-NUX está compuesto de dos elementos de máxima calidad, un taco de nylon de Poliamida 6 y un tornillo (ver diferentes alternativas en la gama. También disponible el taco suelto).



MÁXIMAS PRESTACIONES

La geometría del taco permite que al introducir el tornillo, el taco expanda de una manera uniforme y permita una fijación con unas altas prestaciones de hasta 202 Kg por anclaje (consultar ficha técnica).

GAMA



PRODUCTO	T-NUX A	T-NUX A A4	T-NUX E	T-NUX E A4	T-NUX T	T-FUX E	T-NUX
CABEZA DEL TORNILLO	Avellanada	Avellanada	Hexagonal	Hexagonal	Truss inviolable	Hexagonal sin arandela	Espárrago
RECUBRIMIENTO/MATERIAL DEL TORNILLO	Z	A4	Z	A4	Z	Z	-
TIPO DE CABEZA DEL TACO							
CE	✓	✓	✓	✓	✓	✓	
Fire	✓	✓	✓	✓	✓	✓	

EL RECUBRIMIENTO PERFECTO SEGÚN EL NIVEL DE CORROSIÓN



Material Inoxidable A4: válido para interior y exterior, en zonas costeras o industriales, zonas expuestas a alta contaminación o zonas cercanas a carreteras.



Recubrimiento Cincado: apto para uso en condiciones interiores secas (categoría C1 según la norma ISO 923), por un periodo de 50 años.



Taco de nylon universal de alto rendimiento

T-NUX



MULTIMATERIAL

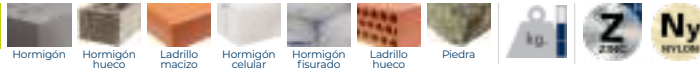

CÓDIGO	MEDIDA	€/100		ESPESOR MÁX. A FIJAR (MM)		
• TNUXA08060	8 x 60 Ø8	48,665	TX30	10	50	600
• TNUXA08080	8 x 80 Ø8	53,266	TX30	10	50	600
• TNUXA08100	8 x 100 Ø8	66,587	TX30	30	50	600
• TNUXA08120	8 x 120 Ø8	77,708	TX30	50	50	300
• TNUXA10060	10 x 60 Ø10	72,126	TX40	10	50	300
TNUXA10080	10 x 80 Ø10	85,014	TX40	10	50	300
TNUXA10100	10 x 100 Ø10	100,185	TX40	30	50	300
TNUXA10120	10 x 120 Ø10	121,496	TX40	50	50	300
TNUXA10140	10 x 140 Ø10	143,405	TX40	70	50	300
TNUXA10160	10 x 160 Ø10	153,060	TX40	90	50	200
TNUXA10180	10 x 180 Ø10	209,119	TX40	110	50	150
TNUXA10200	10 x 200 Ø10	253,516	TX40	130	50	150
TNUXA10230	10 x 230 Ø10	291,960	TX40	160	50	100

• Medidas sin homologar
• Medida sin homologar para fuego

Caja ventana

CÓDIGO	MEDIDA	€/CAJA	PCS	CAJAS
VTNUXA08080	8 x 80 Ø8	5,345	8	8
VTNUXA08100	8 x 100 Ø8	6,681	8	8
VTNUXA10080	10 x 80 Ø10	8,892	8	8
VTNUXA10100	10 x 100 Ø10	10,050	8	8



INOXIDABLE

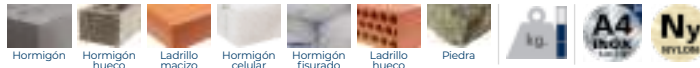

CÓDIGO	MEDIDA	€/100		ESPESOR MÁX. A FIJAR (MM)		
• TNXA408080	8 x 80 Ø8	255,723	TX30	10	50	600
• TNXA408100	8 x 100 Ø8	308,360	TX30	30	50	600
• TNXA408120	8 x 120 Ø8	364,898	TX30	50	50	300
TNXA410080	10 x 80 Ø10	342,620	TX40	10	50	300
TNXA410100	10 x 100 Ø10	409,077	TX40	30	50	300
TNXA410120	10 x 120 Ø10	476,397	TX40	50	50	300
TNXA410140	10 x 140 Ø10	564,920	TX40	70	50	300

• Medida sin homologar para fuego



MULTIMATERIAL

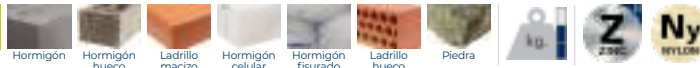

CÓDIGO	MEDIDA	€/100	N° HUELLA	ESPESOR MÁX. A FIJAR (MM)		
• TNUXE08060	8 x 60 Ø8	55,966	SW10/TX30	10	50	600
• TNUXE08080	8 x 80 Ø8	63,781	SW10/TX30	10	50	600
• TNUXE08100	8 x 100 Ø8	81,402	SW10/TX30	30	50	300
• TNUXE08120	8 x 120 Ø8	95,325	SW10/TX30	50	50	300
• TNUXE10060	10 x 60 Ø10	82,437	SW13/TX40	10	50	300
TNUXE10080	10 x 80 Ø10	97,207	SW13/TX40	10	50	300
TNUXE10100	10 x 100 Ø10	118,650	SW13/TX40	30	50	300
TNUXE10120	10 x 120 Ø10	150,389	SW13/TX40	50	50	300
TNUXE10140	10 x 140 Ø10	191,924	SW13/TX40	70	50	200
TNUXE10160	10 x 160 Ø10	192,377	SW13/TX40	90	50	150
TNUXE10180	10 x 180 Ø10	231,924	SW13/TX40	110	50	150
TNUXE10200	10 x 200 Ø10	306,617	SW13/TX40	130	50	150
TNUXE10230	10 x 230 Ø10	377,489	SW13/TX40	160	50	100

• Medidas sin homologar
• Medida sin homologar para fuego

Caja ventana

CÓDIGO	MEDIDA	€/CAJA	PCS	CAJAS
VTNUXE08080	8 x 80 Ø8	6,400	8	8
VTNUXE08100	8 x 100 Ø8	8,081	8	8
VTNUXE10080	10 x 80 Ø10	9,752	8	8
VTNUXE10100	10 x 100 Ø10	11,303	8	8

T-NUX A

Cabeza avellanada. Huella TX. Zincado. Homologado ETE



Disponible en varios recubrimientos. Consulte precio y plazo de entrega.

T-NUX A A4

Inoxidable A4. Cabeza avellanada. Huella TX. Homologado ETE



T-NUX E

Cabeza hexagonal. Huella TX. Zincado. Homologado ETE



Disponible en varios recubrimientos. Consulte precio y plazo de entrega.

T-NUX

Taco de nylon universal de alto rendimiento

T-NUX E A4

Inoxidable A4. Cabeza hexagonal. Huella TX. Homologado ETE



Info. Técnica
P. 401

INOXIDABLE

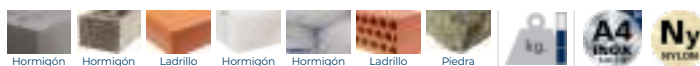

CÓDIGO	MEDIDA	€/100	Nº HUELLA	ESPESOR MÁX. A FIJAR (MM)		
• TNXE408080	8 x 80 Ø8	340,083	SW10/TX30	10	50	600
• TNXE408100	8 x 100 Ø8	403,086	SW10/TX30	30	50	300
TNXE410080	10 x 80 Ø10	451,086	SW13/TX40	10	50	300
TNXE410100	10 x 100 Ø10	471,096	SW13/TX40	30	50	300
TNXE410120	10 x 120 Ø10	597,720	SW13/TX40	50	50	300
TNXE410140	10 x 140 Ø10	733,937	SW13/TX40	70	50	200

• Medida sin homologar para fuego

T-NUX T

Cabeza Truss inviolable. Huella TX. Zincado. Homologado ETE



Info. Técnica
P. 401

MULTIMATERIAL

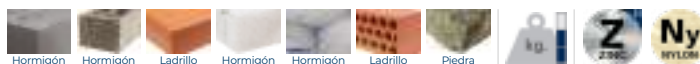

CÓDIGO	MEDIDA	€/100	HUELLA	ESPESOR MÁX. A FIJAR (MM)		
TNUXT10080	10 x 80 Ø10	98,130	TX40	10	50	300
TNUXT10100	10 x 100 Ø10	116,713	TX40	30	50	300
TNUXT10120	10 x 120 Ø10	134,332	TX40	50	50	200
TNUXT10140	10 x 140 Ø10	161,787	TX40	70	50	200
TNUXT10160	10 x 160 Ø10	172,680	TX40	90	50	200

T-FUX E

Taco cabeza cilíndrica. Tornillo cabeza hexagonal. Huella TX. Zincado. Homologado ETE



Info. Técnica
P. 401

MULTIMATERIAL

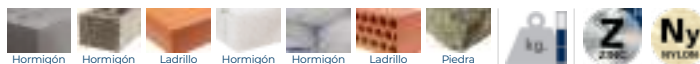

CÓDIGO	MEDIDA	€/100	HUELLA	ESPESOR MÁX. A FIJAR (MM)		
• TFUXE10080	10 x 80 Ø10	107,411	SW13/TX40	10	50	300
TFUXE10100	10 x 100 Ø10	129,747	SW13/TX40	30	50	200
TFUXE10120	10 x 120 Ø10	169,380	SW13/TX40	50	50	200
TFUXE10140 NEW	10 x 140 Ø10	218,250	SW13/TX40	70	50	200

• Medida sin homologar para fuego

T-NUX

Taco de nylon



MULTIMATERIAL

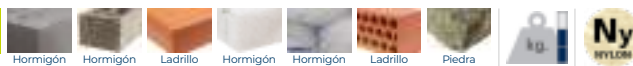

CÓDIGO	MEDIDA	€/100	ESPESOR MÁX. A FIJAR (MM)		
TNUX08060	8 x 60	24,293	-	50	800
TNUX08080	8 x 80	26,200	-	50	600
TNUX08100	8 x 100	30,200	-	50	600
TNUX08120	8 x 120	33,307	-	50	600
TNUX10060	10 x 60	31,317	-	50	600
TNUX10080	10 x 80	31,753	-	50	600
TNUX10100	10 x 100	38,643	-	50	600
TNUX10120	10 x 120	45,520	-	50	600
TNUX10140	10 x 140	59,287	-	50	300



Taco clavable poliamida 6.6

TCA



MULTIMATERIAL



CÓDIGO	MEDIDA	€/100		ESPEJOR MÁX. A FIJAR (MM)		
TC6A08080	8 x 80 Ø8	55,463	TX30	15	100	600
TC6A08100	8 x 100 Ø8	64,473	TX30	35	100	400
TC6A08120	8 x 120 Ø8	76,200	TX30	55	100	400
TC6A10100	10 x 100 Ø10	91,510	TX40	25	100	300
TC6A10120	10 x 120 Ø10	97,160	TX40	40	100	300
TC6A10140	10 x 140 Ø10	112,193	TX40	60	100	300
TC6A10160	10 x 160 Ø10	131,653	TX40	85	100	200
TC6A10200	10 x 200 Ø10	218,673	TX40	125	100	-

TC-6A

Taco de 6 alas con tornillo avellanado



MULTIMATERIAL



CÓDIGO	MEDIDA	€/100		ESPEJOR MÁX. A FIJAR (MM)		
TC6E08080	8 x 80 Ø8	63,500	SW10/TX30	15	100	600
TC6E08100	8 x 100 Ø8	74,033	SW10/TX30	35	100	400
TC6E08120	8 x 120 Ø8	88,003	SW10/TX30	55	100	300
TC6E10100	10 x 100 Ø10	106,950	SW13/TX40	25	100	300
TC6E10120	10 x 120 Ø10	110,893	SW13/TX40	40	100	300
TC6E10140	10 x 140 Ø10	130,887	SW13/TX40	60	100	200
TC6E10160	10 x 160 Ø10	154,647	SW13/TX40	85	100	200
TC6E10200	10 x 200 Ø10	261,003	SW13/TX40	125	100	-

TC-6E

Taco de 6 alas con tornillo hexagonal



MULTIMATERIAL



CÓDIGO	MEDIDA	€/100		ESPEJOR MÁX. A FIJAR (MM)		
TC2A06060	6 X 60 Ø6	32,480	PZ 2	30	100	1.200
TC2A08060	8 X 60 Ø8	42,883	PZ 3	20	100	600
TC2A08080	8 x 80 Ø8	58,237	PZ 3	40	100	600
TC2A08100	8 x 100 Ø8	67,697	PZ 3	60	100	400
TC2A08120	8 x 120 Ø8	80,010	PZ 3	80	100	400
TC2A10065	10 x 65 Ø10	82,303	PZ 4	20	100	400
TC2A10080	10 x 80 Ø10	87,543	PZ 4	35	100	400
TC2A10100	10 x 100 Ø10	96,087	PZ 4	55	100	300
TC2A10115	10 x 115 Ø10	102,017	PZ 4	70	100	300
TC2A10135	10 x 135 Ø10	117,803	PZ 4	90	100	300
TC2A10160	10 x 160 Ø10	138,237	PZ 4	115	100	200

TC-2A

Taco de 2 alas con tornillo avellanado



TC-SP

Taco clavable de alta expansión

TC-SP

Taco con cabeza avellanada



02 Info. Técnica P. 402

MULTIMATERIAL



CÓDIGO	MEDIDA	€/100	Nº HUELLA	ESPESOR MÁX. A FIJAR (MM)		
TCSP05027	5 x 27	9,430	PZ2	5	100	2.400
TCSP06032	6 x 32	11,097	PZ2	5	100	1.200
TCSP06040	6 x 40	11,497	PZ2	10	100	1.200

TC-SP EP

Bote de plástico



MULTIMATERIAL

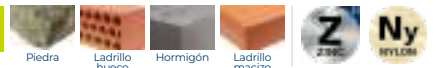

CÓDIGO	MEDIDA	€/PC	Nº HUELLA	ESPESOR MÁX. A FIJAR (MM)	PCS. X BOTE	
TCSPEP05027	5 x 27	68,511	PZ2	5	750	1
TCSPEP06032	6 x 32	53,808	PZ2	5	500	1
TCSPEP06040	6 x 40	58,345	PZ2	10	500	1

TC

Taco clavable de poliamida 6.6, premontado con tornillo rosca-arpón

TC-A2

Taco con cabeza avellanada y tornillo inoxidable A2



02 Info. Técnica P. 403

INOXIDABLE

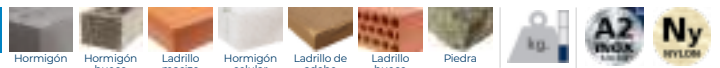

CÓDIGO	MEDIDA	€/100		ESPESOR MÁX. A FIJAR (MM)		
TCA205030	5 x 30 Ø5	46,088	PZ2	5	100	2.400
TCA206040	6 x 40 Ø6	59,964	PZ2	10	100	1.200
TCA206060	6 x 60 Ø6	85,789	PZ2	30	100	1.200
TCA208060	8 x 60 Ø8	135,022	PZ3	20	100	600
TCA208080	8 x 80 Ø8	158,402	PZ3	40	100	600
TCA208100	8 x 100 Ø8	208,343	PZ3	60	100	600

TC-CC

Taco con cabeza cilíndrica



02 Info. Técnica P. 403

MULTIMATERIAL

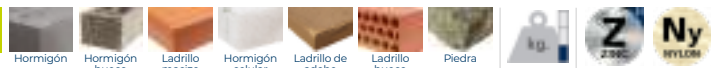

CÓDIGO	MEDIDA	€/100		ESPESOR MÁX. A FIJAR (MM)	UD. MIN. VENTA		
TCCC05025	5 x 25 Ø5	7,236	PZ2	5	400	100	2.400
TCCC05030	5 x 30 Ø5	7,566	PZ2	5	400	100	2.400
TCCC05035	5 x 35 Ø5	8,820	PZ2	10	400	100	2.400
TCCC05050	5 x 50 Ø5	10,465	PZ2	25	200	100	1.200
TCCC06035	6 x 35 Ø6	9,617	PZ2	10	400	100	1.200
TCCC06040	6 x 40 Ø6	9,707	PZ2	15	400	100	1.200
TCCC06050	6 x 50 Ø6	12,369	PZ2	25	200	100	1.200
TCCC06060	6 x 60 Ø6	13,793	PZ2	35	200	100	1.200
TCCC06070	6 x 70 Ø6	17,037	PZ2	45	200	100	1.200
TCCC06080	6 x 80 Ø6	19,880	PZ2	55	-	100	1.200
TCCC08060	8 x 60 Ø8	22,264	PZ3	20	200	100	600
TCCC08080	8 x 80 Ø8	28,193	PZ3	40	200	100	600
TCCC08100	8 x 100 Ø8	34,472	PZ3	60	100	100	600
TCCC08120	8 x 120 Ø8	41,706	PZ3	80	100	100	400
TCCC08140	8 x 140 Ø8	52,357	PZ3	100	100	100	300

Taco clavable de poliamida 6.6, premontado con tornillo rosca-arpón

TC



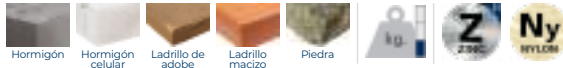

MULTIMATERIAL



TC-CA

Taco con cabeza avellanada

CÓDIGO	MEDIDA	€/100	+	ESPESOR MÁX. A FIJAR (MM)	UD. MIN. VENTA		
TCCA05025	5 x 25 Ø5	7,236	PZ2	5	400	100	2.400
TCCA05030	5 x 30 Ø5	7,566	PZ2	5	400	100	2.400
TCCA05035	5 x 35 Ø5	8,820	PZ2	10	400	100	2.400
TCCA05050	5 x 50 Ø5	10,465	PZ2	25	200	100	1.200
TCCA06035	6 x 35 Ø6	9,617	PZ2	10	400	100	1.200
TCCA06040	6 x 40 Ø6	9,707	PZ2	10	400	100	1.200
TCCA06050	6 x 50 Ø6	12,369	PZ2	20	200	100	1.200
TCCA06060	6 x 60 Ø6	13,793	PZ2	30	200	100	1.200
TCCA06070	6 x 70 Ø6	17,037	PZ2	40	200	100	1.200
TCCA06080	6 x 80 Ø6	19,880	PZ2	50	200	100	1.200
TCCA08060	8 x 60 Ø8	22,264	PZ3	20	200	100	600
TCCA08080	8 x 80 Ø8	28,193	PZ3	40	200	100	600
TCCA08100	8 x 100 Ø8	34,472	PZ3	60	100	100	600
TCCA08120	8 x 120 Ø8	41,706	PZ3	80	100	100	400
TCCA08140	8 x 140 Ø8	52,357	PZ3	100	100	100	300



TAMBIÉN DISPONIBLE EN
easykits



Blíster

CÓDIGO	MEDIDA	€/BOLSA	PCS	BOLSAS
BZTCCA05030	5 x 30 Ø5	2,582	4	20
BZTCCA05050	5 x 50 Ø5	2,582	4	20
BZTCCA06040	6 x 40 Ø6	2,582	4	20
BZTCCA06050	6 x 50 Ø6	2,582	4	20
BZTCCA06060	6 x 60 Ø6	2,582	4	20
BZTCCA06070	6 x 70 Ø6	2,582	4	20
BZTCCA08060	8 x 60 Ø8	2,582	4	20
BZTCCA08080	8 x 80 Ø8	2,582	4	20
BZTCCA08100	8 x 100 Ø8	2,582	2	20
BZTCCA08120	8 x 120 Ø8	2,582	2	20

Caja ventana

CÓDIGO	MEDIDA	€/CAJA	PCS	CAJAS
VTCCA05025	5 x 25 Ø5	3,358	30	8
VTCCA05030	5 x 30 Ø5	3,456	30	8
VTCCA05035	5 x 35 Ø5	3,886	30	8
VTCCA05050	5 x 50 Ø5	4,207	30	8
VTCCA06035	6 x 35 Ø6	3,937	30	8
VTCCA06040	6 x 40 Ø6	4,041	30	8
VTCCA06050	6 x 50 Ø6	4,569	30	8
VTCCA06060	6 x 60 Ø6	4,577	25	8
VTCCA06070	6 x 70 Ø6	5,652	25	8
VTCCA08060	8 x 60 Ø8	5,498	20	8
VTCCA08080	8 x 80 Ø8	7,020	20	8

MULTIMATERIAL



TC-CA EP

Bote de plástico

CÓDIGO	MEDIDA	€/PC	+	ESPESOR MÁX. A FIJAR (MM)	UD. MIN. VENTA	PCS. X BOTE	
TCCAEP5030	5 x 30 Ø5	52,428	PZ3	5	2	750	1
TCCAEP6040	6 x 40 Ø6	45,714	PZ3	10	2	500	1



TN4S

Los tacos de nylon anudables TN4S de INDEX, ofrecen unas máximas prestaciones gracias a su expansión en 4 direcciones. Destacan por su versatilidad en la instalación, siendo aptos para su aplicación tanto en materiales macizos (hormigón, ladrillo macizo), como en materiales huecos (ladrillo hueco, bloques de hormigón hueco, placa yeso). Pueden llegar a soportar cargas de más de 600 kg por punto de apoyo. Están fabricados con Nylon® de alta calidad (poliamida 6).



CUALIDADES Y VENTAJAS



MÁXIMAS PRESTACIONES

Expande en 4 direcciones, lo que garantiza una perfecta adherencia sobre el material base. En los materiales huecos, al introducir el tornillo/tirafondo, el taco se anuda retrayéndose y presionando sobre el material base y permitiendo un correcto agarre.



MULTIMATERIAL

Recomendado tanto para materiales base macizos (hormigón, piedra, ladrillo macizo, ladrillo de adobe, hormigón celular), como huecos (ladrillo hueco, bloque hueco, placa de yeso laminado, placas alveolares).



VERSATILIDAD

Recomendable para utilizar con una amplia gama de tornillos (tornillos con rosca aglomerado, tornillos avellanados, tornillos barraqueros...), así como otro tipo de productos (alcayatas o hembrillas).



FACILIDAD DE USO

El collarín evita que el taco se cuele en el interior del material base durante la instalación. El taco dispone de varios anti-giros laterales que ayudan a que el taco no gire al introducir el tornillo/tirafondo.

APLICACIONES



- Verjas
- Barandillas
- Soportes
- Estanterías
- Rótulos
- Sanitarios y/o instalaciones de baños
- Cuadros
- Elementos ligeros
- Iluminación
- Rodapiés
- Buzones
- Muebles de TV
- Canaletas eléctricas
- Muebles

TN4S

Taco de nylon anudable de 4 segmentos para todo tipo de materiales

TN4S

Taco



MULTIMATERIAL



CÓDIGO	MEDIDA	€/100	MEDIDA TORNILLO	UD. MIN. VENTA		
TN4S05	5 x 25 Ø5	3,587	TPPO 3-4	400	100	4.200
TN4S06	6 x 30 Ø6	3,753	TPPO 4-5	400	100	3.200
TN4S08	8 x 40 Ø8	5,940	TPPO 4,5, TB 5-6	400	100	1.600
TN4S10	10 x 50 Ø10	10,667	TB 6-8	200	50	800
TN4S12	12 x 60 Ø12	20,930	TB 8-10	50	25	400
TN4S14	14 x 70 Ø14	28,040	TB 10-12	40	20	320



CÓDIGO	MEDIDA	€/BOLSA	PCS BOLSAS	BOLSAS
BZTN4S05	5 x 25 Ø5	2,582	25	15
BZTN4S06	6 x 30 Ø6	2,582	25	15
BZTN4S08	8 x 40 Ø8	2,582	15	10
BZTN4S10	10 x 50 Ø10	2,582	10	10
BZTN4S12	12 x 60 Ø12	2,582	6	10

TN4S EP

Bote de plástico



MULTIMATERIAL



CÓDIGO	MEDIDA	€/PC	MEDIDA TORNILLO	UD. MIN. VENTA	PCS. X BOTE		
TN4S06EP	6 x 30 Ø6	34,227	TPPO 4-5	2	1.000	1	3
TN4S08EP	8 x 40 Ø8	28,418	TPPO 4,5, TB 5-6	2	500	1	3
TN4S10EP	10 x 50 Ø10	30,023	TB 6-8	2	300	1	3



Taco de nylon anudable de 4 segmentos para todo tipo de materiales

TN4S



MULTIMATERIAL



Blíster

CÓDIGO	MEDIDA	€/BOLSA	PCS	BOLSAS
BZALHATS05	5 x 25 Ø5 + 19x70 / 4,4x50	2,582	6	20
BZALHATS06	6 x 30 Ø6 + 20x80 / 5x53	2,582	6	15
BZALHATS08	8 x 40 Ø8 + 21x100 / 5,6x60	2,582	4	20

TN4S + AL-HA

Taco + hembra abierta



MULTIMATERIAL



Blíster

CÓDIGO	MEDIDA	€/BOLSA	PCS	BOLSAS
BZALHCTS05	5 x 25 Ø5 + 19x70 / 4,4x50	2,582	6	20
BZALHCTS06	6 x 30 Ø6 + 19x80 / 5x53	2,582	6	15
BZALHCTS08	8 x 40 Ø8 + 21x100 / 5,6x60	2,582	4	20

TN4S + AL-HC

Taco + hembra cerrada



MULTIMATERIAL



Blíster

CÓDIGO	MEDIDA	€/BOLSA	PCS	BOLSAS
BZALROTS05	5 x 25 Ø5 + 18x50 / 4,1x37	2,582	6	20
BZALROTS06	6 x 30 Ø6 + 19x60 / 4,4x46	2,582	6	15
BZALROTS08	8 x 40 Ø8 + 20x80 / 5x63	2,582	4	20

TN4S + AL-RO

Taco + alcazata roscada



MULTIMATERIAL



Caja ventana

CÓDIGO	MEDIDA	€/CAJA	PCS	CAJAS
VTBTS08	8 x 40 Ø8 & 6 x 60	6,463	25	8
VTBTS10	10 x 50 Ø10 & 7 x 70	6,700	15	8
VTBTS12	12 x 60 Ø12 & 7 x 70	6,444	10	8

Blíster

CÓDIGO	MEDIDA	€/BOLSA	PCS	BOLSAS
BZTBS10	10x50 Ø10+7x70	2,582	4	20

TN4S + DIN-571

Taco + tornillo barraquero



MULTIMATERIAL



Caja ventana

CÓDIGO	MEDIDA	€/CAJA	PCS	CAJAS
VTPPOTS05	5 x 25 Ø5 & 4 x 30	4,581	40	8
VTPPOTS06	6 x 30 Ø6 & 4,5 x 40	4,779	32	8
VTPPOTS08	8 x 40 Ø8 & 5 x 60	5,050	20	8

Blíster

CÓDIGO	MEDIDA	€/BOLSA	PCS	BOLSAS
BZTPPOTS05	5x25 Ø5+4x30	2,582	6	20
BZTPPOTS06	6x30 Ø6+4,5x40	2,582	6	20
BZTPPOTS08	8x40 Ø8+5x60	2,582	6	15

TN4S + TP-PO

Taco + tirafondo



TN4S

Taco de nylon anudable de 4 segmentos para todo tipo de materiales

NEW TN4S + TP-PO Z

Taco + tirafondo cincado



MULTIMATERIAL



CÓDIGO	MEDIDA	€/100		
TPPOZTS05	5x25 Ø5 + 4x30	13,267	100	3.200
TPPOZTS06	6x30 Ø6 + 4,5x40	16,740	100	1.600
TPPOZTS08	8x40 Ø8 + 5x60	23,623	50	800
TPPOZTS10	10x50 Ø10 + 6x60	35,863	25	400

TN4S + TP-PO EP

Taco + Tirafondo. Bote de plástico



MULTIMATERIAL



CÓDIGO	MEDIDA	€/PC	PCS. X BOTE		
TPPOTS06EP	6x30 Ø6 + 4,5x40	24,259	250	1	6
TPPOTS08EP	8x40 Ø8 + 5x50	21,660	150	1	6

TN4S-L

Taco largo



MULTIMATERIAL



CÓDIGO	MEDIDA	€/100	MEDIDA TORNILLO		
TN4S06L	6 x 45 Ø6	6,983	TPPO 4-5	100	1.600
TN4S08L	8 x 60 Ø8	12,737	TPPO 4,5, TB 5-6	50	800
TN4S10L	10 x 80 Ø10	23,783	TB 6-8	25	400

TN4S-A

Taco con collarín



MULTIMATERIAL



CÓDIGO	MEDIDA	€/100	MEDIDA TORNILLO		
TN4SA06	6	4,250	TPPO 3,5-4	100	2.400

TN4S-A EP

Taco con collarín. Bote de plástico



MULTIMATERIAL



CÓDIGO	MEDIDA	€/PC	MEDIDA TORNILLO	PCS. X BOTE	
TN4SA06EP	6	39,879	TPPO 4-5	1.000	1



Taco universal con collarín y forma de nudo

MEDU



HUECOS



CÓDIGO	MEDIDA	€/100	UD. MIN. VENTA		
MEDUB06	6 x 35 Ø6	3,500	600	150	2.400
MEDUB07	8 x 45 Ø8	7,843	400	100	1.600
MEDUB08	8 x 50 Ø8	6,013	320	80	1.200
MEDUB10	10 x 60 Ø10	9,003	200	50	800



Taco de nylon

TACON



MULTIMATERIAL



CÓDIGO	MEDIDA	€/100	MEDIDA TORNILLO	UD. MIN. VENTA		
TACON04	4 x 20 Ø4	3,015	TPPO 2,5-3	400	100	8.000
TACON05	5 x 25 Ø5	2,293	TPPO 2,5-4	400	100	8.000
TACON06	6 x 30 Ø6	2,353	TPPO 3,5-4	400	100	9.000
TACON07	7 x 30 Ø7	4,910	TPPO 4-4,5	400	100	5.000
TACON08	8 x 40 Ø8	4,633	TPPO 4,5, TB 5-6	400	100	5.000
TACON10	10 x 50 Ø10	7,810	TB 6-8	200	50	2.500
TACON12	12 x 60 Ø12	14,310	TB 8-10	100	25	1.250
TACON14	14 x 70 Ø14	23,137	TB 10-12	80	20	1.000
TACON16	16 x 80 Ø16	131,147	TB 12-14	40	10	500

Taco



Blíster

CÓDIGO	MEDIDA	€/BOLSA	PCS	BOLSAS
BZTACON04	4 x 20 Ø4	2,040	25	15
BZTACON05	5 x 25 Ø5	2,040	25	15
BZTACON06	6 x 30 Ø6	2,040	25	15
BZTACON08	8 x 40 Ø8	2,040	15	10
BZTACON10	10 x 50 Ø10	2,040	10	10
BZTACON12	12 x 60 Ø12	2,040	5	10



MULTIMATERIAL



CÓDIGO	MEDIDA	€/100	MEDIDA TORNILLO	UD. MIN. VENTA		
TACOL05	5 x 25 Ø5	2,595	TPPO 2,5-4	400	100	8.000
TACOL06	6 x 30 Ø6	2,632	TPPO 3,5-4	400	100	9.000
TACOL08	8 x 40 Ø8	4,980	TPPO 4,5, TB 5-6	400	100	5.000
TACOL10	10 x 50 Ø10	10,044	TB 6-8	200	50	2.500
TACOL12	12 x 60 Ø12	18,883	TB 8-10	100	25	1.250

TACOL

Taco con collarín



MULTIMATERIAL



CÓDIGO	MEDIDA	€/100	MEDIDA TORNILLO		
TACOLA06	6 x 30 Ø6	3,575	TPPO 3,5-4	100	2.400

TACOL-A

Taco de nylon con collarín ancho





FIJACIONES Y ACCESORIOS PARA SISTEMAS DE AISLAMIENTO TÉRMICO (SATE)



AIS-C

Taco de fijación de paneles aislantes. Taco con clavo de poliamida. Homologado ETE

02 Info. Técnica
P. 403

MULTIMATERIAL



CÓDIGO	MEDIDA	€/100	ESPESOR MÁX. A FIJAR (MM)	UD. MIN. VENTA	
AISC10070	Ø10 x 70	22,757	20	200	200
AISC10090	Ø10 x 90	24,318	40	200	200
AISC10100	Ø10 x 100	25,476	50	-	200
AISC10120	Ø10 x 120	27,760	70	-	200
AISC10140	Ø10 x 140	29,542	90	-	200
AISC10160	Ø10 x 160	33,709	110	-	200
AISC10180	Ø10 x 180	35,650	130	-	200
AISC10200	Ø10 x 200	39,672	150	-	200
AISC10220	Ø10 x 220	47,080	170	-	200
AISC10260	Ø10 x 260	52,891	210	-	100

AIS-S

Taco de fijación de paneles aislantes. Taco con clavo metálico y tapón de poliamida. Homologado ETE

02 Info. Técnica
P. 404

MULTIMATERIAL



CÓDIGO	MEDIDA	€/100	ESPESOR MÁX. A FIJAR (MM)	UD. MIN. VENTA	
AISS10070	Ø10 x 70	47,954	20	200	200
AISS10090	Ø10 x 90	51,409	40	200	200
AISS10100	Ø10 x 100	61,142	50	200	200
AISS10120	Ø10 x 120	66,621	70	200	200
AISS10140	Ø10 x 140	70,898	90	200	200
AISS10160	Ø10 x 160	80,899	110	200	200
AISS10180	Ø10 x 180	86,076	130	200	200
AISS10200	Ø10 x 200	96,051	150	200	200
AISS10220	Ø10 x 220	113,818	170	200	200
AISS10260	Ø10 x 260	121,469	210	200	200

AIS

Taco de fijación de paneles aislantes

02 Info. Técnica
P. 404

MULTIMATERIAL

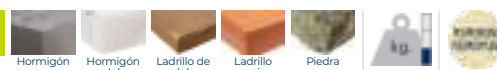

CÓDIGO	MEDIDA	€/100	ESPESOR MÁX. A FIJAR (MM)		
AIS08080	Ø8 x 80	21,597	50	100	200
AIS08100	Ø8 x 100	24,370	70	100	-
AIS08120	Ø8 x 110	28,396	80	100	-
AIS08140	Ø8 x 130	28,494	100	100	-

AIS-R

Taco de fijación de paneles aislantes. Rosetón

02 Info. Técnica
P. 404

MULTIMATERIAL



CÓDIGO	MEDIDA	€/100	
AISR140	Ø140	43,263	200

Taco de fijación de paneles aislantes. Rosetón para uso con tornillo

AIS-W



MULTIMATERIAL



CÓDIGO	MEDIDA	€/100	500
AISW060	Ø60	24,168	500



Taco metálico de fijación de paneles aislantes

AIS-M



MULTIMATERIAL



CÓDIGO	MEDIDA	€/100	ESPESOR MÁX. A FIJAR (MM)	250
AISM08090	Ø8 x 90	31,920	50	250
AISM08110	Ø8 x 110	37,527	70	250
AISM08120	Ø8 x 120	38,760	80	250
AISM08140	Ø8 x 140	43,510	100	250
AISM08170	Ø8 x 170	52,157	130	250
AISM08200	Ø8 x 200	67,357	160	250
AISM08250	Ø8 x 250	79,040	210	250
AISM08300	Ø8 x 300	129,580	260	250



Arandela de taco metálico para fijación de paneles aislantes

AIS-AM



MULTIMATERIAL



CÓDIGO	MEDIDA	€/100	250
AISAM085	Ø85	97,567	250



Anclaje espiral para fijación sobre paneles aislantes

TE



MULTIMATERIAL



CÓDIGO	MEDIDA	€/100	50	600
TE25050	25 x 50	76,667	50	600
TE25090	25 x 90	130,340	25	300





FIJACIONES PARA MATERIALES HUECOS



BA

Basculantes por gravedad para la fijación de elementos ligeros en falsos techos

BA-ES



Espiga



 *Info. Técnica*
P. 406

HUECOS



CÓDIGO	MEDIDA	€/100	UD. MIN. VENTA		
BAESM04	M4 Ø14	70,110	100	50	300
BAESM05	M5 Ø14	76,202	100	50	300
BAESM06	M6 Ø16	92,630	100	50	200
BAESM08	M8 Ø20	149,363	50	50	200

 **Blíster**

CÓDIGO	MEDIDA	€/BOLSA	PCS P/B	BOLSAS
BZBAESM04	M4 Ø14	3,377	2	12
BZBAESM05	M5 Ø14	3,377	2	12
BZBAESM06	M6 Ø16	3,377	2	10

TAMBIÉN DISPONIBLE EN
easykits

NEW BA-NY

Nylon



 *Info. Técnica*
P. 406

HUECOS



CÓDIGO	MEDIDA	€/100		
BANYM05	M5 Ø13	135,000	25	100
BANYM06	M6 Ø13	135,000	25	100

BA-GA

Gancho



 *Info. Técnica*
P. 406

HUECOS



CÓDIGO	MEDIDA	€/100	UD. MIN. VENTA		
BAGAM04	M4 Ø14	74,376	100	50	300
BAGAM05	M5 Ø14	79,380	100	50	300
BAGAM06	M6 Ø16	99,200	100	50	200
BAGAM08	M8 Ø20	162,827	50	50	150

 **Blíster**

CÓDIGO	MEDIDA	€/BOLSA	PCS P/B	BOLSAS
BZBAGAM04	M4 Ø14	3,377	2	12
BZBAGAM05	M5 Ø14	3,377	2	12
BZBAGAM06	M6 Ø16	3,377	2	10

TAMBIÉN DISPONIBLE EN
easykits

CA-BA

Cabeza de basculante



HUECOS



CÓDIGO	MEDIDA	€/100		
CABA004	M4 Ø14	36,145	100	1.200
CABA005	M5 Ø14	38,718	100	1.200
CABA006	M6 Ø16	43,893	100	600
CABA008	M8 Ø20	72,680	100	400

TAMBIÉN DISPONIBLE EN
easykits



Palomilla con muelle

PA

 Info
Técnica
P. 407

HUECOS



CÓDIGO	MEDIDA	€/100	UD. MIN. VENTA		
PAESM04	M4 Ø12	49,467	100	50	300
PAESM05	M5 Ø15	54,800	100	50	300
PAESM06	M6 Ø18	68,340	100	50	200
PAESM08	M8 Ø22	121,643	50	50	150

Blíster

CÓDIGO	MEDIDA	€/BOLSA	PCS BOLSA	BOLSAS
BZPAESM04	M4 Ø12	3,377	2	12
BZPAESM05	M5 Ø15	3,377	2	12
BZPAESM06	M6 Ø18	3,377	2	10

 Info
Técnica
P. 407

HUECOS



CÓDIGO	MEDIDA	€/100	UD. MIN. VENTA		
PAGAM04	M4 Ø12	52,959	100	50	300
PAGAM05	M5 Ø15	59,321	100	50	300
PAGAM06	M6 Ø18	80,891	100	50	200
PAGAM08	M8 Ø22	134,470	50	50	150

Blíster

CÓDIGO	MEDIDA	€/BOLSA	PCS BOLSA	BOLSAS
BZPAGAM04	M4 Ø12	3,377	2	12
BZPAGAM05	M5 Ø15	3,377	2	12
BZPAGAM06	M6 Ø18	3,377	2	10

HUECOS



CÓDIGO	MEDIDA	€/100		
CAPA004	M4 Ø12	19,333	100	2.400
CAPA005	M5 Ø15	20,179	100	1.200
CAPA006	M6 Ø18	26,373	100	600
CAPA008	M8 Ø22	53,388	100	400

Caja ventana

CÓDIGO	MEDIDA	€/CAJA	PCS CAJAS	CAJAS
VCAPA004	M4 Ø12	6,832	24	8
VCAPA005	M5 Ø15	6,736	20	8
VCAPA006	M6 Ø18	6,182	15	8

PA-ES

Espiga



PA-GA

Gancho



CA-PA

Cabeza de palomilla



IN Anclaje Indemoll para fijación en elementos huecos



IN-CO

Con tornillo cabeza redonda





 **Info Técnica**
P. 407



CÓDIGO	MEDIDA	€/100	ESPESOR MÁX. A FIJAR (MM)		
INCO421	M4 x 30 Ø 8	23,307	17 -hmin	100	2.400
INCO432	M4 x 41 Ø 8	26,243	22 -hmin	100	1.200
INCO438	M4 x 47 Ø 8	27,651	30 -hmin	100	1.200
INCO446	M4 x 53 Ø 8	30,080	33 -hmin	100	1.200
INCO459	M4 x 67 Ø 8	35,743	52 -hmin	100	1.200
INCO537	M5 x 46 Ø 10	37,520	26 -hmin	100	1.200
INCO552	M5 x 59 Ø 10	41,413	42 -hmin	100	600
INCO565	M5 x 72 Ø 10	49,167	55 -hmin	100	600
INCO580	M5 x 89 Ø 10	57,063	61 -hmin	100	600
INCO637	M6 x 46 Ø 12	45,358	25 -hmin	100	1.200
INCO652	M6 x 59 Ø 12	51,153	38 -hmin	100	600
INCO665	M6 x 72 Ø 12	57,007	49 -hmin	100	600
INCO680	M6 x 89 Ø 12	69,807	78 -hmin	100	600

 **Blíster**

CÓDIGO	MEDIDA	€/BOLSA	PCS 	BOLSAS 
BZINCO432	M4 x 41 Ø 8	2,582	2	20
BZINCO438	M4 x 47 Ø 8	2,582	2	20
BZINCO537	M5 x 46 Ø 10	2,582	2	20
BZINCO552	M5 x 59 Ø 10	2,582	2	15
BZINCO565	M5 x 72 Ø 10	2,582	2	15
BZINCO637	M6 x 46 Ø 12	2,582	2	15
BZINCO652	M6 x 59 Ø 12	2,582	2	15

 **Caja ventana**

CÓDIGO	MEDIDA	€/CAJA	PCS 	CAJAS 
VINCO432	M4 x 41 Ø 8	4,934	15	8
VINCO438	M4 x 47 Ø 8	5,335	15	8
VINCO446	M4 x 53 Ø 8	5,844	15	8
VINCO537	M5 x 46 Ø 10	6,787	15	8
VINCO552	M5 x 59 Ø 10	5,824	12	8
VINCO637	M6 x 46 Ø 12	5,129	10	8
VINCO652	M6 x 59 Ø 12	5,968	10	8

IN-HE

Con tornillo cabeza hexagonal



 **Info Técnica**
P. 407





CÓDIGO	MEDIDA	€/100	ESPESOR MÁX. A FIJAR (MM)		
INHE837	M8 x 45 Ø 14	89,063	25 -hmin	100	600
INHE855	M8 x 60 Ø 14	102,453	36 -hmin	100	400
INHE865	M8 x 73 Ø 14	121,987	47 -hmin	100	400

IN-SI

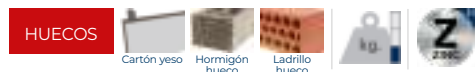
Sin tornillo





CÓDIGO	MEDIDA	€/100	ESPESOR MÁX. A FIJAR (MM)		
INSI421	M4 x 21 Ø 8	18,265	17 -hmin	100	2.400
INSI432	M4 x 32 Ø 8	19,844	22 -hmin	100	2.400
INSI438	M4 x 38 Ø 8	20,495	30 -hmin	100	2.400
INSI537	M5 x 37 Ø 10	28,273	26 -hmin	100	1.200
INSI552	M5 x 52 Ø 10	29,860	42 -hmin	100	600
INSI565	M5 x 65 Ø 10	33,117	55 -hmin	100	600
INSI637	M6 x 37 Ø 12	30,869	25 -hmin	100	1.200
INSI652	M6 x 52 Ø 12	36,882	38 -hmin	100	600
INSI665	M6 x 65 Ø 12	41,319	49 -hmin	100	600
INSI865	M8 x 65 Ø 14	81,453	47 -hmin	100	400

Anclaje Indemoll para fijación en elementos huecos

IN

HUECOS



CÓDIGO	MEDIDA	€/100		
INPINZANI	M4,M5 y M6	1.696,170	1	20

INPIN

Pinza



HUECOS



CÓDIGO	€/100		
INPISANIN	3.369,864	1	10

INPIS

Pistola



HUECOS



CÓDIGO	COMPONENTES	MEDIDA COMPONENTES	UDS X KIT	€/KIT	KITS X 
KITINPIN01	INPINZANI	-	1	52,552	1
	INCO432	M4 x 41 Ø 8	20		
	INCO537	M5 x 46 Ø 10	20		

KITINPIN

Kit de tabiquería seca





ANCLA

Taco de nylon para ladrillos huecos y tablaroca



HUECOS



CÓDIGO	MEDIDA	€/100	UD. MIN. VENTA		
ANCLA40	10 x 40 Ø10	11,787	200	100	600
ANCLA47	10 x 47 Ø10	13,367	200	100	600



Blíster

CÓDIGO	MEDIDA	€/BOLSA	PCS	BOLSAS
BZANCLA40	10 x 40 Ø10	2,582	4	12
BZANCLA47	10 x 47 Ø10	2,582	4	12

TAPLA

Taco para placas de yeso laminado

TAPLA NY

Taco de nylon



HUECOS



CÓDIGO	MEDIDA	€/100		MÍN. ESPESOR MATERIAL BASE	
TAPLANY	15 x 33	11,590	PH2/PH3	9-16	100



Blíster

CÓDIGO	MEDIDA	€/BOLSA	PCS	BOLSAS
BZTAPLANY	15 x 33	2,582	4	15

TAPLA ME

Taco de Zamak con tornillo DIN 7981 4,2 x 32



HUECOS



CÓDIGO	MEDIDA	€/100		MÍN. ESPESOR MATERIAL BASE	UD. MIN. VENTA		
TAPLAME	13 x 32	32,641	PH2/PH3	9-16	200	100	1.600



Blíster

CÓDIGO	MEDIDA	€/BOLSA	PCS	BOLSAS
BZTAPLAME	13 x 32	3,377	4	15

TAPLA ZK

Taco de Zamak



HUECOS



CÓDIGO	MEDIDA	€/100		MÍN. ESPESOR MATERIAL BASE	UD. MIN. VENTA		
TAPLAZK	13 x 37	32,525	PH3	9-16	200	100	1.600



REMACHES





RE-NO

Cabeza alomada. Aluminio





METAL



CÓDIGO	MEDIDA	€/100	Ø BROCA	ESPESOR MÁX. A FIJAR (MM)		
RENO3206	3,2 x 6	3,588	3,3	1-3	500	12.000
RENO3208	3,2 x 8	3,657	3,3	3-5	500	12.000
RENO3210	3,2 x 10	3,887	3,3	5-7	500	6.000
RENO3212	3,2 x 12	4,416	3,3	7-9	500	6.000
RENO3214	3,2 x 14	4,528	3,3	9-11	500	6.000
RENO3216	3,2 x 16	5,310	3,3	11-13	500	6.000
RENO3218	3,2 x 18	5,456	3,3	13-15	500	6.000
RENO4006	4 x 6	4,453	4,1	0,5-2	500	6.000
RENO4008	4 x 8	4,657	4,1	2-4	500	6.000
RENO4010	4 x 10	4,836	4,1	4-6	500	6.000
RENO4012	4 x 12	5,759	4,1	6-8	500	6.000
RENO4014	4 x 14	6,302	4,1	8-10	500	6.000
RENO4016	4 x 16	6,923	4,1	10-12	500	6.000
RENO4018	4 x 18	7,397	4,1	12-14	500	3.000
RENO4020	4 x 20	7,643	4,1	14-16	500	3.000
RENO4025	4 x 25	9,754	4,1	16-18	250	3.000
RENO4030	4 x 30	11,352	4,1	23-16	250	3.000
RENO4035	4 x 35	14,226	4,1	26-30	250	3.000
RENO4806	4,8 x 6	5,954	5	0,5-1,5	500	6.000
RENO4808	4,8 x 8	6,546	5	1,5-3,5	500	6.000
RENO4810	4,8 x 10	6,669	5	3,5-5,5	500	3.000
RENO4812	4,8 x 12	7,027	5	5,5-7,5	500	3.000
RENO4814	4,8 x 14	8,297	5	7,5-9,5	250	3.000
RENO4816	4,8 x 16	9,187	5	9,5-11,5	250	3.000
RENO4818	4,8 x 18	9,959	5	11,5-13,5	250	3.000
RENO4820	4,8 x 20	11,287	5	13,5-15	250	3.000
RENO4822	4,8 x 22	12,397	5	15-17	200	2.400
RENO4824	4,8 x 24	12,713	5	17-19	200	2.400
RENO4826	4,8 x 26	13,787	5	19-21	200	2.400
RENO4828	4,8 x 28	14,664	5	21-23	200	2.400
RENO4830	4,8 x 30	15,939	5	23-25	200	2.400
RENO4835	4,8 x 35	16,687	5	25-30	150	1.800
RENO6008	6 x 8	15,929	6,1	1-2	250	3.000
RENO6010	6 x 10	15,442	6,1	2-4	250	3.000
RENO6012	6 x 12	15,852	6,1	3-6	250	3.000
RENO6016	6 x 16	17,371	6,1	15-19	250	1.500
RENO6018	6 x 18	18,057	6,1	6-10	200	1.200
RENO6025	6 x 25	22,250	6,1	10-12	200	1.200





Blíster

CÓDIGO	MEDIDA	€/BOLSA	PCS 	BOLSAS 
BZRENO3208	3,2 x 8	2,040	15	20
BZRENO3210	3,2 x 10	2,040	15	20
BZRENO4008	4 x 8	2,040	15	20
BZRENO4010	4 x 10	2,040	15	20
BZRENO4012	4 x 12	2,040	15	20
BZRENO4016	4 x 16	2,040	15	20
BZRENO4810	4,8 x 10	2,040	15	20
BZRENO4812	4,8 x 12	2,040	15	20
BZRENO4816	4,8 x 16	2,040	8	20
BZRENO4820	4,8 x 20	2,040	8	20
BZRENO4824	4,8 x 24	2,040	8	20





Caja ventana

CÓDIGO	MEDIDA	€/CAJA	PCS 	CAJAS 
VRENO3206	3,2 x 6	3,010	50	8
VRENO3208	3,2 x 8	3,073	50	8
VRENO3210	3,2 x 10	3,097	50	8
VRENO3212	3,2 x 12	3,483	50	8
VRENO3214	3,2 x 14	3,610	50	8
VRENO3218	3,2 x 18	4,573	50	8
VRENO4006	4 x 6	3,262	50	8
VRENO4008	4 x 8	3,276	50	8
VRENO4010	4 x 10	3,503	50	8
VRENO4012	4 x 12	3,820	50	8
VRENO4014	4 x 14	4,317	50	8
VRENO4016	4 x 16	4,503	50	8
VRENO4018	4 x 18	4,810	50	8
VRENO4020	4 x 20	4,970	50	8
VRENO4808	4,8 x 8	4,437	50	8
VRENO4810	4,8 x 10	4,567	50	8
VRENO4812	4,8 x 12	4,810	50	8
VRENO4814	4,8 x 14	5,507	50	8
VRENO4816	4,8 x 16	5,973	50	8
VRENO4818	4,8 x 18	6,817	50	8
VRENO4820	4,8 x 20	7,347	50	8
VRENO4822	4,8 x 22	4,033	25	8
VRENO4824	4,8 x 24	4,097	25	8
VRENO4830	4,8 x 30	4,940	25	8
VRENO4835	4,8 x 35	5,430	25	8

Remaches

RE



CÓDIGO	MEDIDA	€/100	Ø BROCA	ESPESOR MÁX. A FIJAR (MM)		
REIN3206	3,2 x 6,4	15,697	3,3	0,5 - 3	500	6.000
REIN3208	3,2 x 8	16,793	3,3	3 - 5	500	6.000
REIN3212	3,2 x 12,7	24,747	3,3	6,5 - 8,5	500	6.000
REIN3215	3,2 x 15,9	29,900	3,3	10,5 - 12,5	500	6.000
REIN4008	4 x 8,5	28,190	4,1	2,5 - 4,5	500	6.000
REIN4010	4 x 10,2	29,997	4,1	4,5 - 6,5	500	6.000
REIN4012	4 x 12	33,997	4,1	6,5 - 8,5	500	6.000
REIN4016	4 x 16	41,163	4,1	10 - 12	500	3.000
REIN4810	4,8 x 10,8	41,473	5	4 - 6	500	3.000
REIN4812	4,8 x 12	45,333	5	6 - 8	500	3.000
REIN4816	4,8 x 16	55,733	5	8 - 11	250	3.000
REIN4818	4,8 x 18	59,590	5	13 - 15	250	3.000
REIN4820	4,8 x 20,3	78,197	5	11 - 13	250	3.000

RE-IN

Cabeza alomada. Acero inoxidable A2



CÓDIGO	MEDIDA	€/100	Ø BROCA	ESPESOR MÁX. A FIJAR (MM)		
RECA4008	4 x 8	6,913	4,1	2 - 4	500	3.000
RECA4010	4 x 10	7,493	4,1	4 - 6	500	3.000
RECA4012	4 x 12	8,833	4,1	6 - 8	250	3.000
RECA4016	4 x 16	10,093	4,1	10 - 12	250	3.000
RECA4810	4,8 x 10	10,773	5	3,5 - 5,5	250	3.000
RECA4812	4,8 x 12	11,307	5	5,5 - 7,5	250	3.000
RECA4814	4,8 x 14	12,273	5	7,5 - 9,5	250	3.000
RECA4816	4,8 x 16	13,137	5	9,5 - 11,5	250	1.500
RECA4818	4,8 x 18	14,000	5	11,5 - 13,5	200	2.400

RE-CA

Cabeza ancha. Aluminio



 Blíster

CÓDIGO	MEDIDA	€/BOLSA	PCS BOLSA	BOLSAS
BZRECA4010	4 x 10	2,040	8	15
BZRECA4012	4 x 12	2,040	8	15
BZRECA4016	4 x 16	2,040	8	15
BZRECA4810	4,8 x 10	2,040	8	15
BZRECA4812	4,8 x 12	2,040	8	15
BZRECA4814	4,8 x 14	2,040	8	15
BZRECA4816	4,8 x 16	2,040	8	15
BZRECA4818	4,8 x 18	2,040	5	15

 Caja ventana

CÓDIGO	MEDIDA	€/CAJA	PCS CAJAS	CAJAS
VRECA4010	4 x 10	4,692	50	8
VRECA4012	4 x 12	3,996	35	8
VRECA4016	4 x 16	4,478	35	8
VRECA4810	4,8 x 10	3,670	25	8
VRECA4812	4,8 x 12	3,692	25	8
VRECA4814	4,8 x 14	4,187	25	8
VRECA4816	4,8 x 16	4,375	25	8
VRECA4818	4,8 x 18	3,809	20	8



CÓDIGO	MEDIDA	€/100	Ø BROCA	ESPESOR MÁX. A FIJAR (MM)		
RENO3208BL	3,2 x 8 9003	7,590	3,3	3,5 - 5	500	6.000
RENO3210BL	3,2 x 10 9003	8,023	3,3	5 - 7	500	6.000
RENO3212BL	3,2 x 12 9003	8,417	3,3	7 - 9	500	6.000
RENO4008BL	4 x 8 9003	9,247	4,1	3 - 5	500	6.000
RENO4010BL	4 x 10 9003	10,007	4,1	5 - 6,5	500	6.000
RENO4012BL	4 x 12 9003	10,370	4,1	6,5 - 8,5	500	6.000
RENO4014BL	4 x 14 9003	11,400	4,1	8,5 - 10,5	500	6.000
RENO4810BL	4,8 x 10 9003	13,703	4,9	4 - 6	500	3.000
RENO4812BL	4,8 x 12 9003	14,410	4,9	6 - 8	500	3.000
RENO4814BL	4,8 x 14 9003	15,723	4,9	8 - 10	250	3.000
RENO4816BL	4,8 x 16 9003	16,363	4,9	10 - 12	250	3.000

RE-BL

Cabeza alomada blanca. Aluminio



RE

Remaches

RE-NE

Cabeza alomada negra. Aluminio



METAL



CÓDIGO	MEDIDA	€/100	Ø BROCA	ESPESOR MÁX. A FIJAR (MM)		
RENO3208NE	3,2 x 8 9005	7,590	3,3	3,5-5	500	6.000
RENO3210NE	3,2 x 10 9005	8,023	3,3	5-7	500	6.000
RENO3212NE	3,2 x 12 9005	8,417	3,3	7-9	500	6.000
RENO4008NE	4 x 8 9005	9,247	4,1	3-5	500	6.000
RENO4010NE	4 x 10 9005	10,007	4,1	5-6,5	500	6.000
RENO4012NE	4 x 12 9005	10,370	4	6,5-8,5	500	6.000
RENO4014NE	4 x 14 9005	11,400	4,1	8,5-10,5	500	6.000
RENO4810NE	4,8 x 10 9005	13,703	4,9	4-6	500	3.000
RENO4812NE	4,8 x 12 9005	14,410	4,9	6-8	500	3.000
RENO4814NE	4,8 x 14 9005	15,723	4,9	8-10	250	3.000
RENO4816NE	4,8 x 16 9005	16,363	4,9	10-12	250	3.000

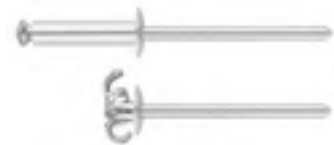

RE-FL

Cabeza alomada. Flor



METAL



CÓDIGO	MEDIDA	€/100	Ø BROCA	ESPESOR MÁX. A FIJAR (MM)		
REFL4012	4 x 12,1	8,694	4,1	4-6,5	500	6.000
REFL4014	4 x 13,9	9,847	4,1	6-9	500	3.000
REFL4016	4 x 15,7	11,730	4,1	8-11	500	3.000
REFL4018	4 x 17,4	12,173	4,1	10-13	500	3.000
REFL4020	4 x 19,2	13,177	4,1	12-15	500	3.000
REFL4025	4 x 25	15,261	4,1	15-20	250	3.000
REFL4814	4,8 x 14,5	12,577	5	4-8	250	3.000
REFL4816	4,8 x 16,3	14,098	5	6-10	250	3.000
REFL4818	4,8 x 18	16,380	5	8-12	250	3.000
REFL4824	4,8 x 24	17,823	5	15-18	200	2.400
REFL4830	4,8 x 30	20,460	5	19-24	200	1.200
REFL4835	4,8 x 35	24,262	5	24-29	150	1.800
REFL4840	4,8 x 40	28,098	5	29-34	150	1.800
REFL4845	4,8 x 45	35,125	5	-	150	900
REFL4850	4,8 x 50	39,001	5	-	150	900



Caja ventana

CÓDIGO	MEDIDA	€/CAJA	PCS 	CAJAS 
VREFL4835	4,8 x 35	8,261	25	8

Tuercas remachables

TR





CÓDIGO	MEDIDA	€/100		
TRAV0411	M4 x 11	14,127	500	12.000
TRAV0513	M5 x 13	15,150	500	6.000
TRAV0616	M6 x 16	18,933	500	3.000
TRAV0819	M8 x 19	22,157	250	3.000
TRAV1021	M10 x 21	33,773	250	1.500

TR-AV

Cabeza avellanada



CÓDIGO	MEDIDA	€/100		
TRCA0310	M3 x 10	9,840	500	12.000
TRCA0410	M4 x 10	20,510	500	12.000
TRCA0411	M4 x 11	20,510	500	12.000
TRCA0512	M5 x 12	22,023	500	12.000
TRCA0515	M5 x 15	22,023	500	6.000
TRCA0614	M6 x 14	27,620	250	3.000
TRCA0616	M6 x 16	27,620	250	3.000
TRCA0816	M8 x 16	20,447	250	3.000
TRCA0818	M8 x 18	21,153	250	1.500
TRCA1017	M10 x 17	33,783	250	1.500
TRCA1022	M10 x 22	34,967	250	1.500
TRCA1223	M12 x 23	56,623	250	1.000

TR-CA

Cabeza ancha



CÓDIGO	MEDIDA	€/100		
TRCR0410	M4 x 10	20,493	500	12.000
TRCR0511	M5 x 11	20,707	500	12.000
TRCR0614	M6 x 14	25,927	250	6.000
TRCR0815	M8 x 15	30,183	250	3.000
TRCR1019	M10 x 19	30,267	250	1.500

TR-CR

Cabeza reducida





RM

Remachadoras

RM-MA

Remachadora manual alicate





CÓDIGO	€/PC		
RMMA01	29,015	1	40

METAL

RM-PA

Remachadora manual palanca



CÓDIGO	€/PC		
RMPA01	180,085	1	10

METAL

RM-EX

Remachadora manual extensible



CÓDIGO	€/PC		
RMEX01	167,710	1	5

METAL



ACCESORIOS PARA CABLE, CADENA Y CERCADOS

U

SJ

Sujetacable DIN 741

SJ-Z

Zincado

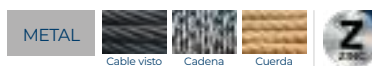

CÓDIGO	MEDIDA	€/100		
SJZ0403	M4(Ø3)	21,327	200	2.400
SJZ0505	M5(Ø5)	24,919	200	1.200
SJZ0506	M5(Ø6 - 6,5)	28,396	100	1.200
SJZ0608	M6(Ø8)	44,934	100	600
SJZ0810	M8(Ø10)	71,707	100	400
SJZ0811	M8(Ø11)	78,982	100	400
SJZ1013	M10(Ø13)	135,911	50	150
SJZ1014	M10(Ø14)	142,378	50	200
SJZ1216	M12(Ø16)	214,668	50	100
SJZ1220	M12(Ø20)	281,381	25	75
SJZ1422	M14(Ø22)	395,173	15	45
SJZ1426	M14(Ø26)	481,097	15	45
SJZ1630	M16(Ø30)	673,407	10	30
SJZ1634	M16(Ø34)	906,306	10	20
SJZ1640	M16(Ø40)	1.131,479	5	15
SJZ1845	M18(Ø45)	2.275,190	5	-
SJZ2050	M20(Ø50)	2.594,929	5	-

Blíster

CÓDIGO	MEDIDA	€/BOLSA	PCS	BOLSAS
BZSJZ0403	M4(Ø3)	4,597	4	20
BZSJZ0505	M5(Ø5)	4,597	2	20
BZSJZ0506	M5(Ø6 - 6,5)	4,597	2	20
BZSJZ0608	M6(Ø8)	4,597	2	20

SJ-A4

Inoxidable A4

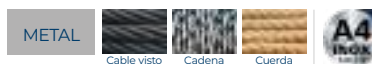

CÓDIGO	MEDIDA	€/100		
SJA42103	M4(Ø3)	175,590	50	1.200
SJA42305	M5(Ø5)	231,300	40	960
SJA42606	M5(Ø6)	252,720	20	900
SJA43008	M6(Ø8)	265,590	20	480
SJA43410	M8(Ø10)	471,150	10	240
SJA43611	M8(Ø11)	685,350	10	240
SJA44414	M10(Ø14)	805,320	5	225
SJA45016	M12(Ø16)	1.280,700	5	120
SJA45418	M12(Ø18)	1.927,530	5	80
SJA46122	M14(Ø22)	2.732,850	1	45
SJA46525	M14(Ø25)	3.062,610	1	24

SJ-O

Sujetacable oval. Zincado

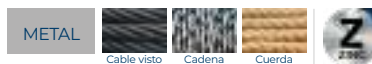

CÓDIGO	MEDIDA	€/100		
SJ00502	M5(Ø2)	87,373	100	1.200
SJ00503	M5(Ø3)	91,533	100	1.200
SJ00604	M6(Ø4)	164,343	100	600
SJ00605	M6(Ø5)	178,903	100	600
SJ00606	M6(Ø6)	194,298	25	600

Sujetacable plano

SJ-P

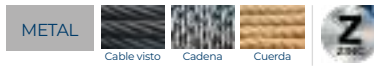



CÓDIGO	MEDIDA	€/100		
SJPS0402	M4(Ø2)	21,635	100	4,500
SJPS0403	M4(Ø3)	22,051	100	2,400
SJPS0504	M5(Ø4)	29,123	100	2,400
SJPS0605	M6(Ø5)	41,607	100	1,200
SJPS0606	M6(Ø6)	58,250	50	600

SJ-PS

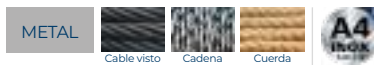
Simple. Zincado





CÓDIGO	MEDIDA	€/100		
SJPSA40403	M4(Ø3)	89,953	30	1,350
SJPSA40504	M5(Ø4)	132,787	30	1,350
SJPSA40605	M6(Ø5)	184,187	20	900
SJPSA40606	M6(Ø6)	312,687	10	450

SJ-PS A4

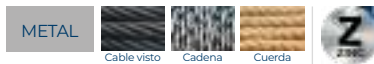
Simple. Inoxidable A4





CÓDIGO	MEDIDA	€/100		
SJPD0402	M4(Ø2)	32,243	100	2,400
SJPD0403	M4(Ø3)	39,111	100	1,200
SJPD0504	M5(Ø4)	49,719	100	1,200
SJPD0605	M5(Ø5)	68,650	50	600
SJPD0606	M6(Ø6)	100,652	50	300
SJPD0808	M8(Ø8)	171,705	25	150

SJ-PD

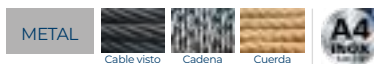
Doble. Zincado



CÓDIGO	MEDIDA	€/100		
SJPDA40403	M4(Ø3)	149,920	30	720
SJPDA40504	M5(Ø4)	244,157	30	720
SJPDA40605	M5(Ø5)	304,123	20	480
SJPDA40606	M6(Ø6)	526,857	10	240

SJ-PD A4

Doble. Inoxidable A4



TS-GA

Tensor gancho/anilla DIN-1480

TS-GA

Zincado

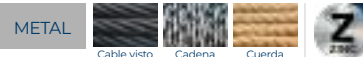

CÓDIGO	MEDIDA	€/100		
TSGA05	M5	166,469	50	300
TSGA06	M6	235,780	50	200
TSGA08	M8	298,185	25	100
TSGA10	M10	441,557	25	75
TSGA12	M12	633,604	10	20
TSGA14	M14	861,497	10	20
TSGA16	M16	1.297,973	10	20
TSGA20	M20	2.229,443	5	-
TSGA22	M22	2.939,963	1	-
TSGA24	M24	4.140,200	1	-
TSGA30	M30	6.613,379	1	-
TSGA36	M36	20.203,968	1	-



CÓDIGO	MEDIDA	€/BOLSA	PCS	BOLSAS
BZTSGA06	M6	4,597	1	20

TS-GA A4

Inoxidable A4



CÓDIGO	MEDIDA	€/100		
TSGAA405	M5	444,531	10	240
TSGAA406	M6	623,235	10	120
TSGAA410	M10	1.620,375	5	30
TSGAA412	M12	3.053,841	5	30

TS-AA

Tensor anilla/anilla DIN-1480

TS-AA

Zincado



CÓDIGO	MEDIDA	€/100		
TSAA05	M5	166,469	50	300
TSAA06	M6	235,780	50	200
TSAA08	M8	298,185	25	100
TSAA10	M10	441,557	25	75
TSAA12	M12	633,604	10	30
TSAA14	M14	861,497	10	20
TSAA16	M16	1.297,973	10	20
TSAA20	M20	2.229,443	5	10
TSAA22	M22	2.939,963	1	-
TSAA24	M24	4.140,200	1	-
TSAA30	M30	6.613,379	1	-
TSAA36	M36	20.203,968	1	-

TS-AA A4

Inoxidable A4

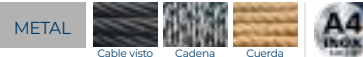

CÓDIGO	MEDIDA	€/100		
TSAAA405	M5	444,531	10	240
TSAAA406	M6	623,235	10	120
TSAAA408	M8	1.126,530	10	60
TSAAA410	M10	1.620,375	5	20
TSAAA412	M12	3.053,841	5	20

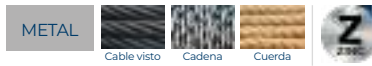

Tensor gancho/gancho DIN-1480

TS-GG



TS-GG

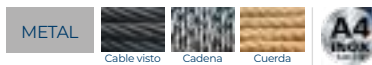

Zincado

CÓDIGO	MEDIDA	€/100		
TSGG05	M5	166,469	50	300
TSGG06	M6	235,780	50	200
TSGG08	M8	298,185	25	75
TSGG10	M10	441,557	25	75
TSGG12	M12	633,604	10	20
TSGG14	M14	861,497	10	20
TSGG16	M16	1.297,973	10	20
TSGG20	M20	2.229,443	5	-
TSGG22	M22	2.939,963	1	-
TSGG24	M24	4.140,200	1	-
TSGG30	M30	6.613,379	1	-
TSGG36	M36	20.203,968	1	-



TS-GG A4

Inoxidable A4



CÓDIGO	MEDIDA	€/100		
TSGGA405	M5	444,531	10	240
TSGGA406	M6	623,235	10	120
TSGGA408	M8	1.126,530	10	-
TSGGA410	M10	1.620,375	5	20
TSGGA412	M12	3.053,841	5	15

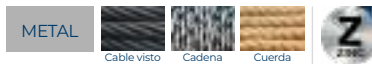

Tensor varilla soldar

TS-VS



CÓDIGO	MEDIDA	€/100		
TSVS06	M6	226,349	50	100
TSVS08	M8	286,258	25	50
TSVS10	M10	423,894	25	50
TSVS12	M12	608,259	25	50
TSVS14	M14	827,037	10	20
TSVS16	M16	1.246,054	10	-
TSVS20	M20	2.140,266	1	-
TSVS22	M22	2.822,364	1	-
TSVS24	M24	3.974,592	1	-
TSVS30	M30	6.348,844	1	-
TSVS36	M36	19.395,809	1	-



EV-H

Cáncamo hembra D-582

EV-H

Zincado



CÓDIGO	MEDIDA	€/100		
EVH06	M6(Ø20)	122,392	100	400
EVH08	M8(Ø20)	128,651	100	400
EVH10	M10(Ø25)	184,704	100	200
EVH12	M12(Ø30)	259,084	100	-
EVH14	M14(Ø35)	384,137	50	150
EVH16	M16(Ø35)	451,664	50	100
EVH18	M18(Ø40)	602,978	50	-
EVH20	M20(Ø40)	619,643	50	-
EVH22	M22(Ø45)	957,370	25	50
EVH24	M24(Ø50)	1.245,220	25	-
EVH27	M28(Ø53)	2.304,323	10	-
EVH30	M30(Ø60)	2.524,333	10	20
EVH36	M36(Ø70)	4.224,670	1	-
EVH42	M42(Ø80)	5.760,810	1	-
EVH48	M48(Ø90)	8.833,243	1	-

EV-H A4

Inoxidable A4

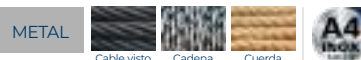

CÓDIGO	MEDIDA	€/100		
EVHA406	M6(Ø15)	188,470	10	450
EVHA408	M8(Ø20)	304,123	10	450
EVHA410	M10(Ø25)	578,260	10	240
EVHA412	M12(Ø30)	856,680	5	120
EVHA414	M14(Ø30)	1.285,020	5	120
EVHA416	M16(Ø35)	1.499,190	1	-
EVHA420	M20(Ø38)	1.970,363	1	-
EVHA424	M24(Ø50)	4.283,400	1	24

EV-M

Cáncamo macho D-580

EV-M

Zincado

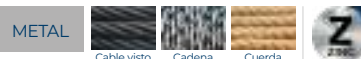

CÓDIGO	MEDIDA	€/100		
EVM06	M6 (Ø20)	122,392	100	400
EVM08	M8 (Ø20)	128,651	100	400
EVM10	M10 (Ø25)	184,704	100	200
EVM12	M12 (Ø30)	259,084	50	100
EVM14	M14 (Ø35)	384,137	50	100
EVM16	M16 (Ø35)	451,664	50	-
EVM18	M18 (Ø40)	602,978	50	-
EVM20	M20 (Ø40)	619,643	25	50
EVM22	M22 (Ø45)	957,370	25	50
EVM24	M24 (Ø50)	1.245,220	25	-
EVM27	M27 (Ø55)	2.304,323	10	-
EVM30	M30 (Ø60)	2.524,333	10	-
EVM33	M33 (Ø65)	3.456,487	1	-
EVM36	M36 (Ø70)	4.224,670	1	-
EVM42	M42(Ø80)	5.760,810	1	-
EVM48	M48 (Ø90)	8.833,243	1	-

EV-M A4

Inoxidable A4

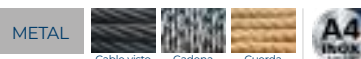

CÓDIGO	MEDIDA	€/100		
EVMA406	M6 (Ø20)	207,317	10	450
EVMA408	M8 (Ø20)	334,536	10	450
EVMA410	M10 (Ø25)	636,086	10	240
EVMA412	M12(Ø30)	942,348	5	120
EVMA414	M14 (Ø35)	1.413,522	5	120
EVMA416	M16 (Ø35)	1.649,109	1	45
EVMA420	M20 (Ø40)	2.167,400	1	-
EVMA424	M24(Ø50)	4.711,740	1	12

Grillete recto

GR

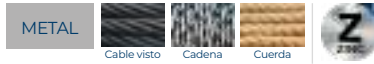

GR-Z

Zincado



CÓDIGO	MEDIDA	€/100		
GRZ05	M5(Ø10)	69,597	50	1.200
GRZ06	M6(Ø12)	73,061	50	600
GRZ08	M8(Ø16)	101,993	50	300
GRZ10	M10(Ø19)	162,692	50	200
GRZ11	M11(Ø22)	218,456	25	150
GRZ12	M12(Ø25)	245,169	25	100
GRZ14	M14(Ø28)	371,783	25	75
GRZ16	M16(Ø32)	529,267	10	40
GRZ18	M18(Ø36)	795,763	5	30
GRZ20	M20(Ø38)	867,355	5	20
GRZ22	M22(Ø44)	1.281,994	1	-
GRZ25	M25(Ø50)	1.836,629	1	-
GRZ28	M28(Ø56)	2.701,272	1	-
GRZ32	M32(Ø64)	4.412,125	1	-
GRZ36	M36(Ø70)	6.492,424	1	-
GRZ38	M38(Ø76)	6.964,179	1	-
GRZ42	M42(Ø76)	13.055,041	1	-
GRZ45	M45(Ø80)	16.141,787	1	-
GRZ50	M50(Ø90)	23.843,777	1	-
GRZ56	M56(Ø100)	46.700,966	1	-
GRZ63	M63(Ø110)	76.401,142	1	-

Blíster

CÓDIGO	MEDIDA	€/BOLSA	PCS	BOLSAS
BZGRZ05	M5(Ø10)	4,597	4	20
BZGRZ06	M6(Ø12)	4,597	4	20
BZGRZ08	M8(Ø16)	4,597	2	20
BZGRZ10	M10(Ø19)	4,597	1	20

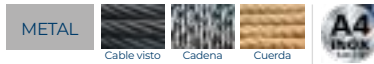

GR-A4

Inoxidable A4



CÓDIGO	MEDIDA	€/100		
GRA404	M4(Ø08)	188,470	25	1.125
GRA405	M5(Ø10)	205,603	25	1.125
GRA406	M6(Ø12)	235,587	25	600
GRA408	M8(Ø16)	351,240	10	240
GRA410	M10(Ø19)	565,410	10	120
GRA412	M12(Ø25)	890,947	5	60
GRA414	M14(Ø28)	1.434,940	5	60
GRA416	M16(Ø32)	2.056,033	5	40
GRA419	M20(Ø38)	4.026,397	1	-
GRA425	M25(Ø50)	8.652,467	1	-

GD

Guardacabo DIN-6899/A

GD-Z

Zincado

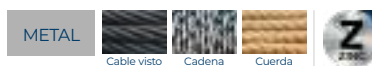

CÓDIGO	MEDIDA	€/100		
GDZ03	M3(Ø12)	31,263	200	2.400
GDZ04	M4(Ø13)	31,987	200	1.200
GDZ05	M5(Ø14)	36,400	200	600
GDZ06	M6(Ø15)	40,887	200	-
GDZ08	M8(Ø18)	50,093	100	200
GDZ10	M10(Ø22)	73,770	100	200
GDZ12	M12(Ø26)	98,150	100	200
GDZ13	M13(Ø28)	162,117	50	-
GDZ15	M15(Ø32)	234,100	50	-
GDZ18	M18(Ø40)	514,133	50	-
GDZ20	M20(Ø44)	778,317	25	-
GDZ24	M24(Ø48)	967,293	10	20

Blíster

CÓDIGO	MEDIDA	€/BOLSA	PCS	BOLSAS
BZGDZ03	M3(Ø12)	4,597	6	20
BZGDZ04	M4(Ø13)	4,597	4	20
BZGDZ05	M5(Ø14)	4,597	4	20
BZGDZ06	M6(Ø15)	4,597	4	20

GD-A4

Inoxidable A4

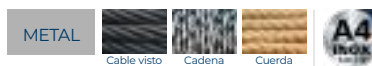

CÓDIGO	MEDIDA	€/100		
GDA402	M2(Ø10)	35,553	100	4.500
GDA403	M3(Ø12)	51,403	100	4.500
GDA404	M4(Ø13)	59,967	50	2.250
GDA405	M5(Ø14)	81,383	50	1.200
GDA406	M6(Ø15)	94,237	50	1.200
GDA408	M8(Ø18)	179,903	50	600
GDA410	M10(Ø22)	295,553	25	300
GDA412	M12(Ø26)	346,957	10	120
GDA415	M15(Ø32)	599,677	5	60

GI

Grillete lira

GI-Z

Zincado

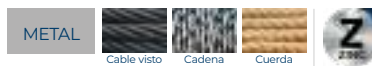

CÓDIGO	MEDIDA	€/100		
GIZ36	M36(Ø78)	5.893,311	1	-
GIZ05	M5(Ø8)	59,529	50	1.200
GIZ06	M6(Ø10)	63,497	50	600
GIZ08	M8(Ø12)	103,184	50	300
GIZ10	M10(Ø16)	162,713	50	200
GIZ11	M11(Ø19)	218,268	25	150
GIZ12	M12(Ø28)	246,050	25	100
GIZ14	M14(Ø33)	380,981	10	60
GIZ16	M16(Ø37)	527,815	10	40
GIZ20	M20(Ø40)	952,453	5	30
GIZ22	M22(Ø47)	1.269,940	1	45
GIZ25	M25(Ø52)	1.785,851	1	-
GIZ28	M28(Ø63)	2.698,618	1	-
GIZ32	M32(Ø75)	4.405,100	1	-

Crillete lira

GI

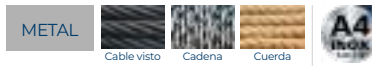

GI-A4

Inoxidable A4



CÓDIGO	MEDIDA	€/100		
GIA404	M4(Ø6)	239,870	25	1.125
GIA405	M5(Ø8)	261,287	25	1.125
GIA406	M6(Ø10)	286,990	10	450
GIA408	M8(Ø12)	428,340	10	240
GIA410	M10(Ø16)	706,760	10	120
GIA412	M12(Ø28)	1.113,683	5	60
GIA414	M14(Ø33)	1.927,530	5	60
GIA416	M16(Ø37)	2.634,290	5	30

Ese zincada

GS

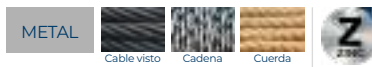

CÓDIGO	MEDIDA	€/100		
GSZ0325	M3(Ø8)	9,923	200	4.800
GSZ0435	M4(Ø10)	12,745	200	2.400
GSZ0545	M5(Ø13)	21,034	200	1.200
GSZ0655	M6(Ø15)	32,144	100	600
GSZ0765	M7(Ø20)	61,117	50	300
GSZ0875	M8(Ø22)	89,292	50	300
GSZ1010	M10(Ø25)	156,758	25	150

Mosquetón bombero

MQ

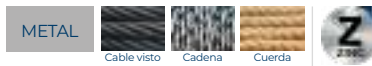

MQ-BS

Con seguro



CÓDIGO	MEDIDA	€/100		
MQBS04	M4(Ø6)	80,974	200	2.400
MQBS06	M6(Ø9)	105,614	100	600
MQBS07	M7(Ø10)	130,257	100	400
MQBS08	M8(Ø12)	161,838	50	300
MQBS09	M9(Ø15)	224,994	25	150
MQBS10	M10(Ø14,7)	242,916	25	150
MQBS11	M11(Ø18)	371,039	25	100
MQBS12	M12(Ø20)	482,309	10	60

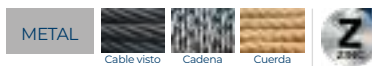

MQ-B

Mosquetón bombero



CÓDIGO	MEDIDA	€/100		
MQB04	M4(Ø6)	59,529	100	2.400
MQB05	M5(Ø8)	61,513	100	1.200
MQB06	M6(Ø9)	75,401	100	600
MQB07	M7(Ø10)	97,232	100	600
MQB08	M8(Ø12)	119,056	50	300
MQB09	M9(Ø15)	165,887	25	150
MQB10	M10(Ø15)	198,428	25	150
MQB11	M11(Ø18)	297,643	10	120
MQB12	M12(Ø20)	365,109	10	60
MQB14	M14(Ø25)	821,494	10	40
MQB15	M15(Ø26)	1.150,881	10	30

CM

Accesorios para cercado

CM-BP

Brida poste



METAL



CÓDIGO	MEDIDA	€/100	
CMBRPOS33	33-35	167,267	250
CMBRPOS40	40-43	205,103	200
CMBRPOS42	42-45	221,715	200
CMBRPOS48	48-52	239,018	200
CMBRPOS50	50-53	249,631	200
CMBRPOS60	60-62	266,242	150

CM-BT

Brida tensor



METAL



CÓDIGO	MEDIDA	€/100	
CMBRTEN48	48	403,459	200

CM-TA

Tapón



METAL



CÓDIGO	MEDIDA	€/100	
CMTAPON33	33	83,287	500
CMTAPON40	40	88,594	350
CMTAPON42	42	94,131	350
CMTAPON48	48	99,668	300
CMTAPON50	50	126,834	250
CMTAPON60	60	155,039	250

CM-TP

Tapón poste



METAL



CÓDIGO	MEDIDA	€/100	
CMTAPOS33	33	221,945	100
CMTAPOS40	40	243,863	200
CMTAPOS42	42	207,641	200
CMTAPOS48	48	249,400	150

CM-UN

Uña



METAL



CÓDIGO	MEDIDA	€/100	
CMUNAAGUJ	Con agujero	24,859	1.500

Tensores para cercado

CM-T

METAL



CM-TENSO

Tensor de alambre

CÓDIGO	MEDIDA	€/100	
CMTENSOAL	85 x 29,5	117,770	250



METAL



CM-TENSOVE

Tensor de alambre verde

CÓDIGO	MEDIDA	€/100	
CMTENSOVE	85 x 29,5	174,580	250



METAL



CM-TT

Tensor de tornillo

CÓDIGO	MEDIDA	€/100	
CMTENSOTO	Tornillo	132,602	450





ACCESORIOS DE EMPARRADO

TA

Tensores y conectores de alambre para espaldaras de viñedos, cultivos arbóreos, cercados ganaderos, etc...

NEW TA-TF

Tensor final de línea 1 canal para la terminación de los alambres a los postes



CÓDIGO	MEDIDA	€/100	
TATF02	Ø1.8 ÷ Ø3.2	216,600	300

NEW TA-TU

Tensor Universal 2 canales para todo tipo de alambres



CÓDIGO	MEDIDA	€/100	
TATU01	Ø1.4 ÷ Ø2.2	266,000	300
TATU02	Ø1.8 ÷ Ø3.2	277,400	250
TATU03	Ø3.3 ÷ Ø4.2	494,000	150

NEW GO-AN

Goma ancla de caucho 100% sintético

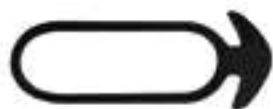

CÓDIGO	MEDIDA	€/1000	
GOAN03B	Nº3	26,000	14.000
GOAN05B	Nº5	25,000	10.000
GOAN05M	Nº5	24,000	10.000
GOAN08B	Nº8	40,000	6.000
GOAN08M	Nº8	40,000	6.000
GOAN10B	Nº10	52,000	7.040
GOAN12B	Nº12	79,000	4.880
GOAN15B	Nº15	112,000	4.400
GOAN18B	Nº18	162,000	3.040
GOAN20B	Nº20	169,000	2.240

Macarrón. Hilo de plástico tubular flexible para atado manual

MC



CÓDIGO	MEDIDA	€/PC	
MCMA025	Ø2,5	24,472	12
MCMA030	Ø3	24,472	12
MCMA040	Ø4	24,472	12

MC-MA **NEW**

Madeja de 2kg



CÓDIGO	MEDIDA	€/PC	
MCOV025	Ø2,5	12,350	12
MCOV030	Ø3	12,350	12
MCOV040	Ø4	12,350	12

MC-OV **NEW**

Ovillo de 1kg



CÓDIGO	MEDIDA	€/PC	
MCPRO5250	Ø5 - L=250mm	7,980	24
MCPRO5400	Ø5 - L=400mm	12,920	16
MCPRO5600	Ø5 - L=600mm	19,304	12

MC-PR **NEW**

Precortado





FIJACIONES Y ACCESORIOS PARA PLACA DE YESO





PL

Tornillo para placa de yeso de altas prestaciones. Fosfatado. Cabeza trompeta, rosca doble hilo y punta alfiler. Huella PH

PL-F

Tornillo

HUECOS



GRATIS - 1 punta en cada caja

CÓDIGO	MEDIDA	€/100		CAPACIDAD DE TALADRO	UD. MIN. VENTA		
PL35019	3,5 x 19	2,320	PH2	< 0.6 mm	2.000	1.000	12.000
PL35025	3,5 x 25	2,100	PH2	< 0.6 mm	2.000	1.000	12.000
PL35035	3,5 x 35	2,700	PH2	< 0.6 mm	2.000	1.000	6.000
PL35045	3,5 x 45	3,307	PH2	< 0.6 mm	1.000	500	6.000
PL35055	3,5 x 55	4,452	PH2	< 0.6 mm	1.000	500	3.000
PL39025	3,9 x 25	2,603	PH2	< 0.6 mm	2.000	1.000	12.000
PL39035	3,9 x 35	3,660	PH2	< 0.6 mm	2.000	1.000	6.000
PL39045	3,9 x 45	4,613	PH2	< 0.6 mm	1.000	500	3.000
PL39055	3,9 x 55	5,520	PH2	< 0.6 mm	1.000	500	3.000
PL42070	4,2 x 70	8,237	PH2	< 0.6 mm	500	500	3.000
PL42080	4,2 x 80	10,947	PH2	< 0.6 mm	500	500	2.000
PL48090	4,8 x 90	18,400	PH2	< 0.6 mm	500	500	1.500
PL48100	4,8 x 100	22,920	PH2	< 0.6 mm	500	500	1.000
PL48110	4,8 x 110	25,350	PH2	< 0.6 mm	500	500	1.000
PL48120	4,8 x 120	28,073	PH2	< 0.6 mm	500	500	1.000
PL48130	4,8 x 130	30,840	PH2	< 0.6 mm	500	500	1.000



Blíster

CÓDIGO	MEDIDA	€/BOLSA	PCS BOLSA	BOLSAS
BZPL35025	3,5 x 25	2,582	50	10
BZPL35035	3,5 x 35	2,582	40	10
BZPL35045	3,5 x 45	2,582	25	10



Caja ventana

CÓDIGO	MEDIDA	€/CAJA	PCS CAJA	CAJAS
VPL35025	3,5 x 25	6,552	250	8
VPL35035	3,5 x 35	8,286	250	8
VPL35045	3,5 x 45	6,258	150	8

PL-EP

Bote de plástico

HUECOS



CÓDIGO	MEDIDA	€/PC		CAPACIDAD DE TALADRO	UD. MIN. VENTA	PCS. X BOTE	
PLEP35025	3,5 x 25	84,060	PH2	< 0.6 mm	1	4.000	1
PLEP35035	3,5 x 35	80,840	PH2	< 0.6 mm	1	3.000	1



Tornillos para placa de yeso. Cabeza ancha

PL-CA



CÓDIGO	MEDIDA	€/100			
PLCAZ4213	4,2 x 13	3,610	PH2	1.000	12.000
PLCAZ4216	4,2 x 16	3,923	PH2	1.000	12.000
PLCAZ4219	4,2 x 19	4,220	PH2	1.000	12.000
PLCAZ4225	4,2 x 25	4,810	PH2	1.000	6.000
PLCAZ4232	4,2 x 32	5,960	PH2	500	6.000
PLCAZ4241	4,2 x 41	6,763	PH2	500	3.000
PLCAZ4251	4,2 x 51	7,660	PH2	200	2.400



Tornillo para placa de yeso de paso ancho. Cabeza trompeta y punta perforante

PL-RA



CÓDIGO	MEDIDA	€/100		UD. MIN. VENTA		
PLRA3925	3,9 x 25	3,283	PH2	2.000	1.000	12.000
PLRA3935	3,9 x 35	4,167	PH2	2.000	1.000	6.000
PLRA3945	3,9 x 45	5,273	PH2	1.000	500	3.000
PLRA3955	3,9 x 55	5,737	PH2	1.000	500	3.000
PLRA4835	4,8 x 35	5,170	PH2	2.000	1.000	6.000



Tornillo para placas de yeso laminado. Cabeza trompeta y punta autotaladrante

PL-TR



CÓDIGO	MEDIDA	€/100		CAPACIDAD DE TALADRO	UD. MIN. VENTA		
PLTR3525	3,5 x 25	2,900	PH2	0,6 - 3 mm	2.000	1.000	12.000
PLTR3535	3,5 x 35	3,683	PH2	0,6 - 3 mm	2.000	1.000	6.000
PLTR3545	3,5 x 45	4,443	PH2	0,6 - 3 mm	1.000	500	6.000





CP

Cintas para placas de yeso laminado

CP-PA

Cinta papel para juntas

HUECOS



CÓDIGO	MEDIDA	€/PC	PCS. X BOTE	
CPPA023	23 m x 50 mm	5,563	1	20
CPPA075	75 m x 50 mm	10,786	1	20
CPPA150	150 m x 50 mm	15,070	1	10



CP-GV

Cinta guardavillos

HUECOS



CÓDIGO	MEDIDA	€/PC		
CPGV012	12,5 m	25,420	1	20
CPGV030	30 m	31,925	1	10



CP-AC

Cinta acústica adhesiva

HUECOS



CÓDIGO	MEDIDA	€/PC	PCS. X BOTE	
CPAC300453	30m x 45 x 3	17,857	1	26
CPAC300703	30m x 70 x 3	27,240	1	17

CP-MV

Cinta malla de vidrio

HUECOS



CÓDIGO	MEDIDA	€/PC	PCS. X BOTE	
CPMV020	20 m	4,130	1	100
CPMV045	45 m	7,773	1	64
CPMV090	90 m	15,813	1	36
CPMV150	150 m	21,963	1	16



Anclaje universal

OME

MULTIMATERIAL



CÓDIGO	MEDIDA	€/100		
OMEM06	M6	53,218	100	1.000



Media abrazadera M6

MAB

METAL



CÓDIGO	MEDIDA	€/100		
MABM6018	18 (M6)	14,730	100	2.400



Horquilla de cuelgue

HO-C

HUECOS



CÓDIGO	MEDIDA	€/100		
HOCUM647	M6 (TC47)	30,727	100	1.000

HO-CU

Por giro



HUECOS



CÓDIGO	MEDIDA	€/100		
HOCRM647	M6 (TC47)	44,750	100	1.000
HOCRM660	M6 (TC60)	60,100	100	-

HO-CR

Recta





EMP

Empalme de perfiles



HUECOS



CÓDIGO	MEDIDA	€/100		
EMPTC45	TC 45	42,677	50	150
EMPTC47	TC 47	40,263	50	500
EMPTC60	TC 60	57,943	50	500



CAB

Caballote para cruce de perfiles



HUECOS



CÓDIGO	MEDIDA	€/100		
CABTC47	TC 47	57,540	50	400
CABTC60	TC 60	80,243	50	-



ADU

Anclaje directo "U" para soporte de perfiles en falsos techos



HUECOS



CÓDIGO	MEDIDA	€/100		
ADUTC47	TC 47	70,827	100	400
ADUTC60	TC 60	72,970	100	400



PCU

Pletina de cuelgue



METAL



CÓDIGO	MEDIDA	€/100	UD. MIN. VENTA		
PCU0005	5	21,397	200	100	800
PCU0006	6	21,457	200	100	800





Accesorio para suspensión

SUS



CÓDIGO	MEDIDA	€/100		
SUSTC47090	90 (TC47)	25,097	100	1.000
SUSTC47180	180 (TC47)	46,043	100	500
SUSTC47240	240 (TC47)	106,233	100	300
SUSTC47300	300 (TC47)	129,467	50	300
SUSTC47400	400 (TC47)	198,100	50	200



Trampillas de registro para placa de yeso laminado

TR



CÓDIGO	MEDIDA	€/PC	
TRBL200200	200 x 200	23,718	1
TRBL300300	300 x 300	36,467	1
TRBL400400	400 x 400	51,345	1
TRBL500500	500 x 500	72,394	1
TRBL600600	600 x 600	91,690	1

TR-BL

Lacada blanca (RAL 9016)



CÓDIGO	MEDIDA	€/PC	
TR13200200	200 x 200	39,063	2
TR13300300	300 x 300	47,656	2
TR13400400	400 x 400	59,303	2
TR13500500	500 x 500	76,499	1
TR13600600	600 x 600	92,736	1

TR-13

13 mm



CÓDIGO	MEDIDA	€/PC	
TR15200200	200 x 200	70,112	2
TR15300300	300 x 300	82,238	2
TR15400400	400 x 400	103,681	2
TR15500500	500 x 500	125,184	1
TR15600600	600 x 600	146,047	1

TR-15

15 mm





INDEX
REINFORCING SYSTEMS

USE APPROPRIATE QUALITY & SIZE OF SELF-DRILLING /
SPLIT SHANK FASTENERS ALWAYS DRILL FIRST / USE CARTRIDGE
APPLICATOR OR VIBRATOR / NEVER OPERATE WITH EXHAUSTIVE VIBRATION

INDEX **FP1200**

- 12V MAX LITHIUM-ION BATTERY (1.5Ah)
- 12V MAX LITHIUM-ION BATTERY (1.5Ah)
- 12V MAX LITHIUM-ION BATTERY (1.5Ah)
- 12V MAX LITHIUM-ION BATTERY (1.5Ah)
- 12V MAX LITHIUM-ION BATTERY (1.5Ah)

INDEX 12V MAX / 12V MAX / 12V MAX
INDEX 12V MAX / 12V MAX / 12V MAX
INDEX 12V MAX / 12V MAX / 12V MAX

FIJACIÓN DIRECTA



FP-GUN

Pistola semiautomática para fijación a pólvora

FP08GUN

Para clavos de 8 mm



POLVORA

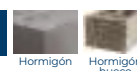

CÓDIGO	MEDIDA	€/PC	
FP08GUN	8mm	815,528	1

FP12GUN

Para clavos de 12 mm



POLVORA

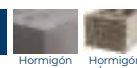

CÓDIGO	MEDIDA	€/PC	
FP12GUN	12mm	1.366,062	1

**PISTOLAS
SUMINISTRADAS
CON MALETÍN
COMPLETO**

CONTENIDO MALETÍN

- Pistola
- Cepillo
- Manual de instrucciones
- Gafas protectoras
- Repuestos
- Aceite lubricante

FP-IM

Impulsores para pistolas de pólvora

FP-IP

Impulsores de pólvora



POLVORA

CÓDIGO	POTENCIA	COLOR	€/100	
FPP3VE	POWER 3	VERDE	51,679	100
FPP4AM	POWER 4	AMARILLO	51,679	100
FPP5RO	POWER 5	ROJO	51,679	100

FP-CR

Impulsores de pólvora en disco

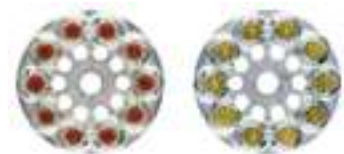

POLVORA



CÓDIGO	POTENCIA	COLOR	€/100	
FPCRRO	POWER 5	ROJO	64,016	100
FPCRAM	POWER 4	AMARILLO	64,016	100

Clavos para pistola FP08 a pólvora

FP-CL08

POLVORA



CÓDIGO	MEDIDA	€/100		
FP080816	3,8 x 16	24,803	100	4.500
FP080819	3,8 x 19	27,527	100	4.500



FP-CG 08

Grafilados con arandela de goma



POLVORA



CÓDIGO	MEDIDA	€/100		
FPCL0816	3,8 x 16	11,940	100	4.500
FPCL0819	3,8 x 19	12,367	100	4.500
FPCL0825	3,8 x 25	12,450	100	4.500
FPCL0827	3,8 x 27	12,824	100	2.400
FPCL0832	3,8 x 32	13,453	100	2.400
FPCL0838	3,8 x 38	15,009	100	2.400
FPCL0844	3,8 x 44	16,059	100	2.400
FPCL0851	3,8 x 51	18,220	100	2.400
FPCL0857	3,8 x 57	18,820	100	2.400
FPCL0864	3,8 x 64	20,910	100	1.200
FPCL0870	3,8 x 70	21,779	100	1.200

FP-CL 08

Estándar con arandela de goma



POLVORA



CÓDIGO	MEDIDA	€/100		
FPAP085166	3,8 x 51	117,352	100	200

FP-AP 08

Estándar con arandela de plástico de 66 mm



POLVORA



CÓDIGO	MEDIDA	€/100	
FP08303708	3,8 x 37	53,971	100
FP08304708	3,8 x 47	55,883	100



FP-C30

Estándar con arandela de plástico de 35 mm



POLVORA



CÓDIGO	MEDIDA	€/100		
FPAM0837	3,8 x 37	33,081	100	600
FPAM0851	3,8 x 51	36,108	100	600

FP-AM 08

Estándar con arandela metálica de 36 mm

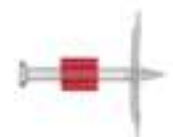

FP-CL08

Clavos para pistola FP08 a pólvora

FP-CR 08 M6

Estándar con rosca M6 x 8 para instalación de abrazaderas

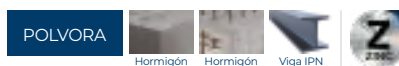

CÓDIGO	MEDIDA	€/100		
FPCR0812	3,8 x 12	29,694	100	2.400
FPCR0822	3,8 x 22	30,556	100	2.400
FPCR0827	3,8 x 27	31,031	100	2.400

FP-CR 08 M8

Estándar con rosca M8 x 8 para instalación de abrazaderas

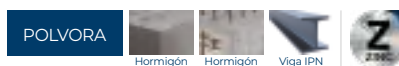

CÓDIGO	MEDIDA	€/100		
FPCRM80812	3,8 x 12	41,348	100	2.400
FPCRM80827	3,8 x 27	43,124	100	2.400

FP-PI 08

Clip abrazadera 13 mm con clavo y goma roja



CÓDIGO	MEDIDA	€/100		
FPPI081613	3,8 x 13	65,320	100	600

FP-CL12

Clavos para pistola FP12 a pólvora

FP-CG 12

Grafilados con arandela metálica de 12 mm



CÓDIGO	MEDIDA	€/100		
FPCG1612	3,8 x 16	16,136	100	4.500
FPCG1912	3,8 x 19	16,581	100	-

FP-CGD 12

Grafilados con arandela doble metálica y plástica



CÓDIGO	MEDIDA	€/100		
FPCGD1612	3,8 x 16	20,591	100	100
FPCGD1912	3,8 x 19	20,845	100	100

FP-CL 12

Estándar con arandela metálica de 12 mm

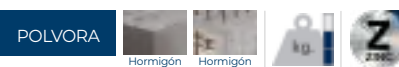



CÓDIGO	MEDIDA	€/100		
FPCL2212	3,8 x 22	16,536	100	-
FPCL2712	3,8 x 27	17,136	100	1.000
FPCL3212	3,8 x 32	18,344	100	1.000
FPCL3712	3,8 x 37	19,406	100	-
FPCL4212	3,8 x 42	20,669	100	-
FPCL4712	3,8 x 47	23,572	100	2.400

Clavos para pistola FP12 a pólvora

FP-CL12

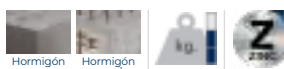
POLVORA



CÓDIGO	MEDIDA	€/100	
FPCLD2212	3,8 x 22	19,183	100
FPCLD2712	3,8 x 27	19,192	100
FPCLD3212	3,8 x 32	21,530	100
FPCLD3712	3,8 x 37	22,772	100
FPCLD4212	3,8 x 42	24,105	100
FPCLD4712	3,8 x 47	26,213	100

FP-CLD 12

Estándar con arandela doble metálica y plástica de 12 mm



POLVORA

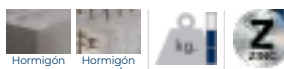

CÓDIGO	MEDIDA	€/100	
FPCT3212	3,8 x 32	43,669	100

FP-CT 12

Para instalación de falsos techos



Recambios para pistolas FP08GUN y FP12GUN

FP-PIS

POLVORA

CÓDIGO	MEDIDA	€/PC	
FPPISCL08	8	56,363	1

Válido para clavos con cabeza cóncava. Ref: FP-AP y FP-C30

FP-PISCL08

Pistón para pistola FP08GUN. Válido para clavos con cabeza cóncava



POLVORA

CÓDIGO	MEDIDA	€/PC	
FPPISPL08	8	56,087	1

Válido para clavos con cabeza plana. Ref: FP-CG, FP-CL, FP-AM, FP-CR, FP-PI.

FP-PISPL08

Pistón plano para pistola FP08GUN. Válido para clavos con cabeza plana



POLVORA

CÓDIGO	MEDIDA	€/PC	
FPPISCL12	12	86,627	1

Válido para clavos con cabeza cóncava. Ref: FP-CG12, FP-CGD12, FP-CL12, FP-CLD12.

FP-PISCL12

Pistón para pistola FP12GUN. Válido para clavos con cabeza cóncava



POLVORA

CÓDIGO	MEDIDA	€/PC	
FPPISCM12	M6 x 8	94,927	1

Válido para clavos de Ø12, M6

FP-PISCM12

Pistón para pistola FP12GUN. Válido para clavos de Ø12, M6



POLVORA

CÓDIGO	MEDIDA	€/PC	
FPPISCT12	12	97,453	1

Válido para clavo FPCT3212

FP-PISCT12

Pistón para pistola FP12GUN. Válido para clavo FPCT3212



FG-GUN

Pistola semiautomática de fijación a gas sin cables

GAS

FG-GUN

Pistola semiautomática de fijación a gas sin cables para tabiquería seca



CÓDIGO	MEDIDA	€/PC	
FG60GUN	Pistola gas / Gas gun / Pistolet gaz	2.160,00	1

CONTENIDO MALETÍN

- Pistola de fijación a gas
- Cargador
- 2 baterías
- Llave Allen
- Manual de instrucciones

PISTOLA SUMINISTRADA CON MALETÍN COMPLETO

- Técnica de anclaje directo para fijaciones ligeras: organizar cableados, colocar perfiles metálicos para la instalación de tabiques de placas de yeso, etc.
- Fijación de metal o madera a hormigón o bloque.
- Pistola suministrada con completo maletín, incluyendo cargador de batería.
- Baterías de larga duración.
- Capacidad para clavos de hasta 40 mm. de longitud.
- Carga de gas suministrada con los consumibles.

FG-GUNEL

Pistola semiautomática de fijación a gas sin cables para electricistas



GAS

CÓDIGO	MEDIDA	€/PC	
FG60GUNEL	Pistola gas / Gas gun / Pistolet gaz	2.479,00	1

CONTENIDO MALETÍN

- Pistola de fijación a gas
- Cargador
- 2 baterías
- Llave Allen
- Manual de instrucciones
- Cañón para electricistas
- Imán

Clavos para pistola de fijación a gas

FG-CL





CÓDIGO	MEDIDA	€/100	
FGCL15	2,6 x 15	12,031	1.000
FGCL20	2,6 x 20	12,530	1.000
FGCL25	2,6 x 25	12,863	1.000
FGCL30	2,6 x 30	13,376	1.000
FGCL35	2,6 x 35	14,588	1.000
FGCL40	2,6 x 40	15,683	1.000

FG-CL

Clavos estándar







CÓDIGO	MEDIDA	€/100		
FGCLH15	3,1 x 15	13,840	1.000	-
FGCLH17	3,1 x 17	14,114	1.000	5.000
FGCLH19	3,1 x 19	14,114	1.000	-
FGCLH22	3,1 x 22	14,542	1.000	-
FGCLH27	3,1 x 27	15,066	1.000	-
FGCLH32	3,1 x 32	15,903	1.000	-

FG-CLH

Clavos para materiales duros



	FG-CLH					FG-CL					
	15	17	22	27	32	15	20	25	30	35	40
	●	●	●	●	○						
	○	●	●	●	●						
	○	●	●	●	●	○	○	○	○	○	○
		○	○	○	○	○	●	●	●	●	●
			○	○	○	●	●	●	●	●	●

●/● Válido para
○/○ Prestaciones reducidas

Accesorios para instalar con pistola de gas

FG-AC





CÓDIGO	MEDIDA	€/100		
OMEM06	M6	53,218	100	1.000

OME

Anclaje universal



CÓDIGO	MEDIDA	€/100		
FGARAM25	Ø25	13,452	200	4.800

FG-ARAM

Arandela metálica



FG-AC

Accesorios para instalar con pistola de gas

FG-ARAM EP

Arandela metálica. Bote de plástico



CÓDIGO	MEDIDA	€/PC	PCS. X BOTE	
FGARAM25EP	Ø25	134,517	1.000	1

FG-PLET

Pletina roscada para varilla



CÓDIGO	MEDIDA	€/100		
FGPLET	M6 - M8	192,916	100	400

AB-PID

Grapa 1 pie para disparo



CÓDIGO	MEDIDA	€/100		
ABPID016	16	12,877	100	1.200
ABPID020	20	18,924	100	1.200
ABPID025	25	22,176	100	600
ABPID032	32	30,715	100	600

FG-ABRA

Abrazadera a presión



CÓDIGO	MEDIDA	€/100		
FGABRA15	15 - 18	59,577	100	-
FGABRA20	20 - 25	62,960	50	200
FGABRA25	25 - 32	75,703	50	-

INSTALACIÓN PISTOLA



FG-BASE

Base para brida



CÓDIGO	COLOR	€/100		
FGBASEGR	GRIS	17,493	100	1.200
FGBASENE	NEGRO	16,173	100	1.200

Accesorios para pistola de gas

FG-APG



CÓDIGO	MEDIDA	€/PC	
FGCAEL	11	200,000	1

FG-CAEL

Cañón de pistola especial para electricistas



CÓDIGO	MEDIDA	€/PC	
FGCLCAR40	40	330,401	1

FG-CLCAR

Cargador para 40 clavos



CÓDIGO	MEDIDA	€/PC	
FGIMAN	∅interior 11,25	160,173	1

FG-IMAN

Imán



CÓDIGO	€/PC	
FG60BAT	380,653	1

FG-BAT

Batería para pistola FP60GUN



CÓDIGO	€/PC	
FG60CAR	299,025	1

FG-CAR

Cargador para pistola FP60GUN



CÓDIGO	MEDIDA	€/PC		
FG60GAS	80 ml.	32,570	1	12

FG-GAS

Cartucho de gas





TORNILLOS PARA CUBIERTAS Y FACHADAS



DIN-7504-K

Tornillo autotaladrante de cabeza hexagonal

DIN-7504-K

Tornillo



Disponible en diferentes colores



Disponible en varios recubrimientos. Consulte precio y plazo de entrega.



CÓDIGO	MEDIDA	€/100				CÓDIGO	MEDIDA	€/100			
ABE3509	3,5 x 9,5	2,213	6	1.000	24.000	ABE5563	5,5 x 63	13,660	8	250	1.000
ABE3513	3,5 x 13	2,287	6	1.000	12.000	ABE5575	5,5 x 75	16,730	8	250	1.500
ABE3516	3,5 x 16	2,603	6	1.000	12.000	ABE6319	6,3 x 19	9,547	10	500	3.000
ABE3519	3,5 x 19	2,767	6	1.000	12.000	ABE6325	6,3 x 25	10,117	10	500	3.000
ABE4213	4,2 x 13	3,190	7	1.000	12.000	ABE6332	6,3 x 32	11,740	10	500	2.000
ABE4216	4,2 x 16	3,400	7	1.000	8.000	ABE6338	6,3 x 38	13,180	10	500	2.000
ABE4219	4,2 x 19	3,830	7	1.000	8.000	ABE6350	6,3 x 50	16,167	10	250	1.500
ABE4225	4,2 x 25	4,553	7	500	6.000	ABE6363	6,3 x 63	19,110	10	250	1.500
ABE4232	4,2 x 32	5,177	7	500	6.000	ABE6375	6,3 x 75	22,363	10	250	1.000
ABE4238	4,2 x 38	5,957	7	500	6.000	ABE6380	6,3 x 80	24,870	10	250	1.000
ABE4813	4,8 x 13	4,133	8	1.000	8.000	ABE6390	6,3 x 90	29,290	10	250	750
ABE4816	4,8 x 16	4,210	8	1.000	6.000	ABE6310	6,3 x 100	31,470	10	100	600
ABE4819	4,8 x 19	4,687	8	500	6.000	ABE6311	6,3 x 110	38,087	10	100	600
ABE4825	4,8 x 25	5,287	8	500	6.000	ABE6312	6,3 x 120	44,913	10	100	600
ABE4832	4,8 x 32	6,547	8	500	3.000	ABE6313	6,3 x 130	50,377	10	100	600
ABE4838	4,8 x 38	7,267	8	500	3.000	ABE6314	6,3 x 140	58,887	10	100	600
ABE5519	5,5 x 19	6,180	8	500	6.000	ABE6315	6,3 x 150	70,257	10	100	600
ABE5522	5,5 x 22	6,430	8	500	4.000	ABE6316	6,3 x 160	77,993	10	100	400
ABE5525	5,5 x 25	6,827	8	500	4.000	ABE6318	6,3 x 180	100,923	10	100	300
ABE5532	5,5 x 32	8,127	8	500	3.000	ABE6320	6,3 x 200	128,807	10	100	300
ABE5538	5,5 x 38	9,223	8	500	3.000	ABE6322	6,3 x 220	163,120	10	100	200
ABE5550	5,5 x 50	11,153	8	500	2.000	ABE6324	6,3 x 240	184,217	10	100	200

Blíster

CÓDIGO	MEDIDA	€/BOLSA	PCS	BOLSAS
BZABE3509	3,5 x 9,5	2,582	20	20
BZABE3513	3,5 x 13	2,582	20	20
BZABE4213	4,2 x 13	2,582	20	20
BZABE4216	4,2 x 16	2,582	20	20
BZABE4219	4,2 x 19	2,582	20	20
BZABE4225	4,2 x 25	2,582	10	20
BZABE4813	4,8 x 13	2,582	20	20
BZABE4816	4,8 x 16	2,582	20	20
BZABE4819	4,8 x 19	2,582	10	20
BZABE4825	4,8 x 25	2,582	10	20
BZABE4832	4,8 x 32	2,582	10	20
BZABE4838	4,8 x 38	2,582	10	20
BZABE5519	5,5 x 19	2,582	10	20
BZABE5522	5,5 x 22	2,582	10	20
BZABE5525	5,5 x 25	2,582	10	20
BZABE5532	5,5 x 32	2,582	10	20
BZABE5538	5,5 x 38	2,582	10	20
BZABE5550	5,5 x 50	2,582	10	20
BZABE6325	6,3 x 25	2,582	10	20
BZABE6332	6,3 x 32	2,582	10	20
BZABE6338	6,3 x 38	2,582	10	20
BZABE6350	6,3 x 50	2,582	5	20

Caja ventana

CÓDIGO	MEDIDA	€/CAJA	PCS	CAJAS
VABE3509	3,5 x 9,5	6,155	225	8
VABE3513	3,5 x 13	6,371	200	8
VABE4213	4,2 x 13	6,349	150	8
VABE4216	4,2 x 16	6,947	150	8
VABE4219	4,2 x 19	7,961	150	8
VABE4225	4,2 x 25	4,768	75	8
VABE4232	4,2 x 32	5,806	75	8
VABE4813	4,8 x 13	8,524	150	8
VABE4816	4,8 x 16	9,147	150	8
VABE4819	4,8 x 19	9,970	150	8
VABE4825	4,8 x 25	11,248	150	8
VABE4832	4,8 x 32	9,341	110	8
VABE4838	4,8 x 38	8,249	85	8
VABE5519	5,5 x 19	10,529	125	8
VABE5522	5,5 x 22	11,066	125	8
VABE5525	5,5 x 25	12,207	125	8
VABE5532	5,5 x 32	9,617	85	8
VABE5538	5,5 x 38	10,074	80	8
VABE5550	5,5 x 50	9,128	60	8
VABE5563	5,5 x 63	7,332	40	8
VABE6319	6,3 x 19	12,647	100	8
VABE6325	6,3 x 25	12,647	90	8
VABE6332	6,3 x 32	11,633	70	8
VABE6338	6,3 x 38	10,787	60	8
VABE6350	6,3 x 50	8,762	40	8
VABE6363	6,3 x 63	6,703	25	8

DIN-7504-K A2

Tornillo. Inoxidable A2



CÓDIGO	MEDIDA	€/100			
ABEI4213	4,2 x 13	16,077	7	1.000	12.000
ABEI4216	4,2 x 16	18,037	7	1.000	8.000
ABEI4219	4,2 x 19	18,697	7	1.000	8.000
ABEI4813	4,8 x 13	22,743	8	1.000	8.000
ABEI4816	4,8 x 16	22,223	8	500	6.000
ABEI4819	4,8 x 19	24,047	8	500	6.000
ABEI4825	4,8 x 25	26,930	8	500	6.000
ABEI4832	4,8 x 32	32,017	8	500	3.000
ABEI5519	5,5 x 19	33,200	8	500	6.000
ABEI5522	5,5 x 22	35,420	8	500	4.000
ABEI5525	5,5 x 25	37,643	8	500	6.000
ABEI6319	6,3 x 19	50,320	10	500	3.000
ABEI6325	6,3 x 25	57,247	10	500	3.000



Tornillo autotaladrante de cabeza hexagonal

DIN-7504-K



DIN-7504-K + ARVUL

Tornillo con arandela vulcanizada de acero-EPDM



Disponibile en diferentes colores



Disponibile en varios recubrimientos. Consulte precio y plazo de entrega.

CÓDIGO	MEDIDA	€/100			
ABE144219	4,2 x 19 P14	8,303	7	1.000	4.000
ABE164219	4,2 x 19 P16	11,017	7	1.000	4.000
ABE144225	4,2 x 25 P14	11,760	7	500	3.000
ABE144816	4,8 x 16 P14	8,233	8	1.000	4.000
ABE164816	4,8 x 16 P16	8,990	8	1.000	4.000
ABE144819	4,8 x 19 P14	7,633	8	1.000	4.000
ABE164819	4,8 x 19 P16	8,643	8	1.000	3.000
ABE184819	4,8 x 19 P18	13,477	8	500	3.000
ABE144825	4,8 x 25 P14	9,473	8	1.000	4.000
ABE164825	4,8 x 25 P16	9,393	8	1.000	3.000
ABE184825	4,8 x 25 P18	14,303	8	500	3.000
ABE144832	4,8 x 32 P14	13,680	8	500	3.000
ABE164832	4,8 x 32 P16	10,087	8	500	3.000
ABE144838	4,8 x 38 P14	15,047	8	500	3.000
ABE164838	4,8 x 38 P16	12,400	8	500	2.000
ABE184838	4,8 x 38 P18	16,453	8	500	2.000
ABE165519	5,5 x 19 P16	10,347	8	1.000	3.000
ABE145522	5,5 x 22 P14	11,390	8	1.000	4.000
ABE165522	5,5 x 22 P16	10,440	8	1.000	3.000
ABE185522	5,5 x 22 P18	14,127	8	500	3.000
ABE255522	5,5 x 22 P25	17,870	8	500	1.500
ABE165525	5,5 x 25 P16	11,297	8	1.000	3.000
ABE185525	5,5 x 25 P18	15,417	8	500	3.000
ABE255525	5,5 x 25 P25	20,077	8	500	1.500
ABE145532	5,5 x 32 P14	14,420	8	1.000	3.000
ABE165532	5,5 x 32 P16	11,987	8	1.000	2.000
ABE185532	5,5 x 32 P18	16,317	8	500	2.000
ABE165538	5,5 x 38 P16	13,703	8	1.000	2.000
ABE185538	5,5 x 38 P18	17,420	8	500	2.000
ABE165550	5,5 x 50 P16	15,540	8	500	1.500
ABE185550	5,5 x 50 P18	20,407	8	500	1.500
ABE165563	5,5 x 63 P16	19,420	8	250	1.500
ABE185563	5,5 x 63 P18	21,630	8	250	1.000
ABE165575	5,5 x 75 P16	22,753	8	250	1.000
ABE166319	6,3 x 19 P16	14,687	10	500	3.000
ABE186319	6,3 x 19 P18	15,950	10	500	3.000
ABE166325	6,3 x 25 P16	13,877	10	500	2.000

CÓDIGO	MEDIDA	€/100			
ABE186325	6,3 x 25 P18	16,170	10	500	2.000
ABE256325	6,3 x 25 P25	22,100	10	500	1.500
ABE166332	6,3 x 32 P16	16,833	10	500	2.000
ABE186332	6,3 x 32 P18	19,223	10	500	2.000
ABE256332	6,3 x 32 P25	24,370	10	500	1.000
ABE166338	6,3 x 38 P16	17,950	10	500	2.000
ABE186338	6,3 x 38 P18	20,577	10	250	1.500
ABE256338	6,3 x 38 P25	26,540	10	250	750
ABE166350	6,3 x 50 P16	20,673	10	500	1.000
ABE186350	6,3 x 50 P18	22,933	10	250	1.000
ABE256350	6,3 x 50 P25	30,437	10	250	750
ABE166363	6,3 x 63 P16	25,573	10	250	1.000
ABE186363	6,3 x 63 P18	26,737	10	250	1.000
ABE256363	6,3 x 63 P25	30,903	10	100	600
ABE166375	6,3 x 75 P16	28,440	10	250	750
ABE186375	6,3 x 75 P18	29,743	10	250	750
ABE166380	6,3 x 80 P16	33,847	10	100	600
ABE186380	6,3 x 80 P18	34,973	10	100	600
ABE256380	6,3 x 80 P25	40,023	10	100	300
ABE166390	6,3 x 90 P16	39,470	10	100	600
ABE186390	6,3 x 90 P18	35,613	10	100	600
ABE256390	6,3 x 90 P25	42,630	10	100	400
ABE166310	6,3 x 100 P16	41,203	10	100	600
ABE186310	6,3 x 100 P18	41,303	10	100	400
ABE256310	6,3 x 100 P25	45,977	10	100	400
ABE166311	6,3 x 110 P16	47,047	10	100	600
ABE186311	6,3 x 110 P18	48,500	10	100	400
ABE256311	6,3 x 110 P25	50,143	10	100	300
ABE166312	6,3 x 120 P16	54,117	10	100	400
ABE186312	6,3 x 120 P18	56,047	10	100	400
ABE256312	6,3 x 120 P25	58,040	10	100	300
ABE166313	6,3 x 130 P16	59,563	10	100	400
ABE186313	6,3 x 130 P18	67,677	10	100	400
ABE256313	6,3 x 130 P25	63,607	10	100	300
ABE166314	6,3 x 140 P16	66,087	10	100	400
ABE186314	6,3 x 140 P18	70,783	10	100	400
ABE256314	6,3 x 140 P25	69,550	10	100	200



Blíster

CÓDIGO	MEDIDA	€/BOLSA	PCS BOLSA	BOLSAS
BZABE144819	4,8 x 19 P14	2,582	18	10
BZABE144825	4,8 x 25 P14	2,582	18	10
BZABE165522	5,5 x 22 P14	2,582	15	10
BZABE165525	5,5 x 25 P16	2,582	15	10
BZABE165532	5,5 x 32 P14	2,582	12	10
BZABE165538	5,5 x 38 P16	2,582	12	10
BZABE165550	5,5 x 50 P16	2,582	10	10
BZABE166325	6,3 x 25 P16	2,582	10	10
BZABE166332	6,3 x 32 P16	2,582	8	10
BZABE166338	6,3 x 38 P16	2,582	8	10

Caja ventana

CÓDIGO	MEDIDA	€/CAJA	PCS CAJA	CAJAS
VABE144819	4,8 x 19 P14	11,372	100	8
VABE164819	4,8 x 19 P16	8,308	70	8
VABE144825	4,8 x 25 P14	10,081	80	8
VABE165522	5,5 x 22 P14	9,344	70	8
VABE165525	5,5 x 25 P16	9,513	60	8
VABE165532	5,5 x 32 P14	8,218	50	8
VABE165538	5,5 x 38 P16	8,370	45	8
VABE165550	5,5 x 50 P16	7,363	35	8
VABE166325	6,3 x 25 P16	9,118	50	8
VABE166332	6,3 x 32 P16	11,637	50	8
VABE166338	6,3 x 38 P16	9,917	40	8



DIN-7504-K CP + ARVUL

Bote de plástico



CÓDIGO	MEDIDA	€/UD		PCS. X BOTE	
ABE144819CP	4,8 x 19 P14	103,808	8	1.250	1
ABE164819CP	4,8 x 19 P16	111,820	8	1.250	1
ABE165522CP	5,5 x 22 P16	134,879	8	1.250	1
ABE166325CP	6,3 x 25 P16	108,508	10	750	1

DIN-7504-K RE Tornillo autotaladrante de punta reducida y cabeza hexagonal de 8 mm

DIN-7504-K RE

Tornillo



Disponible en diferentes colores



Disponible en varios recubrimientos. Consulte precio y plazo de entrega.



CÓDIGO	MEDIDA	€/100			
ARE4816	4,8 x 16	5,673	8	500	6.000
ARE4819	4,8 x 19	5,957	8	500	6.000
ARE5522	5,5 x 22	8,560	8	500	4.000
ARE6320	6,3 x 20	9,377	8	500	3.000
ARE6325	6,3 x 25	11,143	8	500	3.000
ARE6332	6,3 x 32	13,563	8	500	3.000
ARE6338	6,3 x 38	15,613	8	500	3.000
ARE6350	6,3 x 50	19,030	8	250	1.500
ARE6363	6,3 x 63	24,623	8	250	1.500
ARE6380	6,3 x 80	30,613	8	250	1.000

DIN-7504-K RE + ARVUL

Tornillo con arandela vulcanizada de acero-EPDM





Disponible en diferentes colores



Disponible en varios recubrimientos. Consulte precio y plazo de entrega.



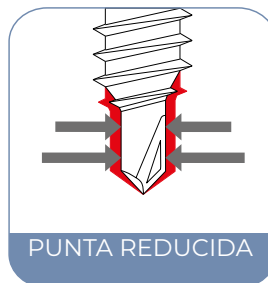

CÓDIGO	MEDIDA	€/100			
ARE164816	4,8 x 16 P16	14,803	8	500	3.000
ARE164819	4,8 x 19 P16	15,483	8	500	3.000
ARE165522	5,5 x 22 P16	15,573	8	500	3.000
ARE166320	6,3 x 20 P16	16,077	8	500	3.000
ARE166325	6,3 x 25 P16	17,560	8	500	3.000
ARE166332	6,3 x 32 P16	23,877	8	500	2.000
ARE166338	6,3 x 38 P16	24,773	8	500	2.000
ARE166350	6,3 x 50 P16	29,327	8	250	1.500



DIN-7504-K RE NI + ARVUL

Tornillo autotaladrante punta reducida Atlantis C4-M + Arandela vulcanizada EPDM-inoxidable A2



CÓDIGO	MEDIDA	€/100			
AREN166325	6,25 x 25 P-16	30,039	8	500	3.000



Tornillo para viga autotaladrante con cabeza hexagonal

AUTO



CÓDIGO	MEDIDA	€/100		ESPESOR MÁX. A FIJAR (MM)	CAPACIDAD DE TALADRO		
AUTO510	5,5 x 100	37,237	8	80	4,00-12,00	100	600
AUTO532	5,5 x 32	14,254	8	21,5	4,00-12,00	500	3.000
AUTO538	5,5 x 38	15,579	8	27,5	4,00-12,00	500	3.000
AUTO550	5,5 x 50	19,336	8	39,5	4,00-12,00	500	2.000
AUTO560	5,5 x 60	22,221	8	49,5	4,00-12,00	250	1.500
AUTO580	5,5 x 80	29,102	8	67	4,00-12,00	250	1.000

AUTO

Tornillo



Disponible en varios recubrimientos. Consulte precio y plazo de entrega.



CÓDIGO	MEDIDA	€/100		ESPESOR MÁX. A FIJAR (MM)	CAPACIDAD DE TALADRO		
AUTO16510	5,5 x 100 P16	43,735	8	78	4,00-12,00	100	600
AUTO16532	5,5 x 32 P16	18,294	8	19,5	4,00-12,00	500	2.000
AUTO16538	5,5 x 38 P16	19,481	8	25,5	4,00-12,00	500	2.000
AUTO16550	5,5 x 50 P16	24,681	8	37,5	4,00-12,00	500	2.000
AUTO16560	5,5 x 60 P16	26,933	8	47,5	4,00-12,00	250	1.000
AUTO16580	5,5 x 80 P16	33,858	8	65	4,00-12,00	250	1.000

AUTO + ARVUL

Tornillo con arandela vulcanizada de acero-EPDM



Disponible en varios recubrimientos. Consulte precio y plazo de entrega.

Tornillo autotaladrante inoxidable bimetálico con cabeza hexagonal

ABE BIMETAL



CÓDIGO	MEDIDA	€/100		ESPESOR MÁX. A FIJAR (MM)	CAPACIDAD DE TALADRO		
BIE4825	4,8 x 25	69,317	8	9	1,75-4,40	500	6.000
BIE5525	5,5 x 25	81,253	8	5	1,75-5,25	500	6.000
BIE5532	5,5 x 32	93,313	8	12	1,75-5,25	500	3.000
BIE5538	5,5 x 38	99,213	8	18	1,75-5,25	500	3.000
BIE5550	5,5 x 50	114,513	8	30	1,75-5,25	500	2.000
BIE5558	5,5 x 58	127,457	8	38	1,75-5,25	250	1.500
BIE5565	5,5 x 65	133,217	8	45	1,75-5,25	250	1.500
BIE5580	5,5 x 80	157,167	8	60	1,75-5,25	250	1.000
BIE6325	6,3 x 25	104,047	10	7	2,50-6,00	500	3.000

ABE BIMETAL

Tornillo



CÓDIGO	MEDIDA	€/100		ESPESOR MÁX. A FIJAR (MM)	CAPACIDAD DE TALADRO		
BIE164825	4,8 x 25 P16	83,140	8	7	1,75-4,40	500	2.000
BIE165525	5,5 x 25 P16	96,320	8	3	1,75-5,25	500	2.000
BIE165532	5,5 x 32 P16	109,580	8	10	1,75-5,25	500	2.000
BIE165538	5,5 x 38 P16	115,253	8	16	1,75-5,25	500	1.500
BIE165550	5,5 x 50 P16	134,430	8	28	1,75-5,25	500	1.500
BIE165558	5,5 x 58 P16	144,637	8	36	1,75-5,25	250	1.500
BIE165565	5,5 x 65 P16	150,527	8	43	1,75-5,25	250	1.500
BIE165580	5,5 x 80 P16	175,167	8	58	1,75-5,25	250	1.000
BIE166325	6,3 x 25 P16	120,333	10	5	2,50-6,00	500	2.000

ABE BIMETAL + ARVUL

Tornillo con arandela vulcanizada de acero-EPDM



AUTO BIMETAL

Tornillo viga autotaladrante inoxidable bimetetal con cabeza hexagonal

NEW ABE A4 BIMETAL

Tornillo inoxidable A4



CÓDIGO	MEDIDA	€/100		
BIE45525	5,5 x 25	106,444	500	4.000
BIE45532	5,5 x 32	115,344	500	3.000
BIE45550	5,5 x 50	147,644	500	2.000
BIE45565	5,5 x 65	177,822	250	1.500
BIE46325	6,3 x 25	137,133	500	3.000

AUTO BIMETAL

Tornillo



CÓDIGO	MEDIDA	€/100		ESPESOR MÁX. A FIJAR (MM)	CAPACIDAD DE TALADRO		
BAUTO5540	5,5 x 40	118,609	8	10	4,00-12,00	500	3.000
BAUTO5550	5,5 x 50	159,790	8	20	4,00-12,00	500	3.000
BAUTO5565	5,5 x 65	166,927	8	35	4,00-12,00	250	1.500
BAUTO5580	5,5 x 80	214,237	8	50	4,00-12,00	250	1.000
BAUTO5510	5,5 x 100	216,643	8	70	4,00-12,00	100	600

AUTO BIMETAL + ARVUL

Tornillo con arandela vulcanizada de acero-EPDM



CÓDIGO	MEDIDA	€/100		ESPESOR MÁX. A FIJAR (MM)	CAPACIDAD DE TALADRO		
BAUTO165540	5,5 x 40 P16	140,588	8	8	4,00-12,00	500	1.500
BAUTO165550	5,5 x 50 P16	184,233	8	18	4,00-12,00	500	1.500
BAUTO165565	5,5 x 65 P16	190,353	8	33	4,00-12,00	250	1.500
BAUTO165580	5,5 x 80 P16	223,733	8	48	4,00-12,00	250	1.000
BAUTO165510	5,5 x 100 P16	238,365	8	68	4,00-12,00	100	600



Los beneficios del tornillo broca de acero con la durabilidad anticorrosión de un inoxidable

RECUBRIMIENTO ATLANTIS C3-H



Tornillo rosca chapa con cabeza hexagonal

AUE



CÓDIGO	MEDIDA	€/100			
AUE6319	6,3 x 19	8,833	10	500	3.000
AUE6325	6,3 x 25	10,237	10	500	3.000
AUE6332	6,3 x 32	11,346	10	500	2.000
AUE6340	6,3 x 40	13,280	10	500	2.000
AUE6350	6,3 x 50	15,586	10	500	1.500
AUE6360	6,3 x 60	17,977	10	250	1.000
AUE6380	6,3 x 80	24,055	10	250	1.000
AUE6310	6,3 x 100	30,699	10	250	750
AUE6311	6,3 x 110	37,121	10	250	750
AUE6312	6,3 x 120	41,257	10	250	750
AUE6313	6,3 x 130	49,749	10	250	750
AUE6314	6,3 x 140	57,488	10	250	500
AUE6315	6,3 x 150	68,639	10	100	400

AUE

Tornillo



Disponible en diferentes colores



Disponible en varios recubrimientos. Consulte precio y plazo de entrega.



CÓDIGO	MEDIDA	€/100			
AUE166319	6,3 x 19 P16	15,617	10	500	2.000
AUE166325	6,3 x 25 P16	16,540	10	500	2.000
AUE186325	6,3 x 25 P18	19,158	10	500	2.000
AUE256325	6,3 x 25 P25	27,829	10	500	1.500
AUE166332	6,3 x 32 P16	18,914	10	500	2.000
AUE186332	6,3 x 32 P18	21,230	10	500	1.500
AUE166340	6,3 x 40 P16	20,896	10	500	1.500
AUE186340	6,3 x 40 P18	25,065	10	500	1.500
AUE166350	6,3 x 50 P16	23,922	10	500	1.500
AUE186350	6,3 x 50 P18	26,071	10	500	1.500
AUE166360	6,3 x 60 P16	28,278	10	250	1.000
AUE186360	6,3 x 60 P18	30,573	10	250	1.000
AUE166380	6,3 x 80 P16	36,081	10	250	750
AUE186380	6,3 x 80 P18	39,630	10	250	750
AUE186310	6,3 x 100 P18	46,274	10	250	750
AUE186311	6,3 x 110 P18	52,442	10	250	500
AUE186312	6,3 x 120 P18	60,316	10	100	400
AUE186313	6,3 x 130 P18	70,506	10	100	400
AUE186314	6,3 x 140 P18	76,527	10	100	400
AUE186315	6,3 x 150 P18	78,384	10	100	400

AUE + ARVUL

Tornillo con arandela vulcanizada de acero-EPDM



Disponible en diferentes colores



Disponible en varios recubrimientos. Consulte precio y plazo de entrega.



CÓDIGO	MEDIDA	€/100		
AUENI166325	6,25 x 25 P-16	35,340	500	2.000

AUE NI + ARVUL

Tornillo autorroscante Atlantis C4-M + Arandela vulcanizada EPDM-inoxidable A2



PS

Tornillo autotaladrante de cabeza hexagonal para panel sándwich

PS 3

Punta broca estándar #3. Zincado



METAL



CÓDIGO	MEDIDA	€/100		ESPESOR MÁX. A FIJAR (MM)	CAPACIDAD DE TALADRO		
PS55060	5,5 / 6,3 x 60	18,171	8	31 - 45	1,50-6,00	500	1.500
PS55082	5,5 / 6,3 x 82	21,974	8	43 - 67	1,50-6,00	500	1.000
PS55098	5,5 / 6,3 x 98	25,098	8	54 - 83	1,50-6,00	500	1.000
PS55115	5,5 / 6,3 x 115	34,418	8	56 - 100	1,50-6,00	500	1.000
PS55130	5,5 / 6,3 x 130	41,446	8	66 - 115	1,50-6,00	200	400
PS55150	5,5 / 6,3 x 150	49,829	8	86 - 135	1,50-6,00	200	400
PS55180	5,5 / 6,3 x 180	83,409	8	116 - 165	1,50-6,00	200	400

PS 3 + ARVUL

Punta broca estándar #3 con arandela vulcanizada de acero-EPDM. Zincado



METAL



CÓDIGO	MEDIDA	€/100		ESPESOR MÁX. A FIJAR (MM)	CAPACIDAD DE TALADRO		
PS1655060	5,5 / 6,3 x 60 P16	24,875	8	31 - 45	1,50-6,00	500	1.000
PS1655082	5,5 / 6,3 x 82 P16	27,791	8	43 - 67	1,50-6,00	500	1.000
PS1655098	5,5 / 6,3 x 98 P16	31,842	8	54 - 83	1,50-6,00	500	1.000
PS1655115	5,5 / 6,3 x 115 P16	38,594	8	56 - 100	1,50-6,00	500	-
PS1655130	5,5 / 6,3 x 130 P16	52,351	8	66 - 115	1,50-6,00	200	-
PS1655150	5,5 / 6,3 x 150 P16	60,138	8	86 - 135	1,50-6,00	200	400
PS1655180	5,5 / 6,3 x 180 P16	98,314	8	116 - 165	1,50-6,00	200	400

PS 3 + ARVUL A2

Punta broca estándar #3 con recubrimiento ATLANTIS C4-M y arandela inoxidable A2



METAL



CÓDIGO	MEDIDA	€/100		ESPESOR MÁX. A FIJAR (MM)	CAPACIDAD DE TALADRO		
PS1955195	5,5 / 6,3 x 195 P19	303,319	8	130 - 185	1,50-6,00	200	400
PS1955230	5,5 / 6,3 x 230 P19	364,325	8	166 - 215	1,50-6,00	200	-

NEW PST 3 + ARVUL A2

Tornillo con punta broca estándar #3 con recubrimiento ATLANTIS C4-M y arandela inoxidable A2



METAL



CÓDIGO	MEDIDA	€/100		ESPESOR MÁX. A FIJAR (MM)	CAPACIDAD DE TALADRO	UD. MIN. VENTA		
PST1655060	5,5 / 6,3 x 60 P16	56,360	8	31 - 45	1,50-6,00	-	100	1.200
PST1655082	5,5 / 6,3 x 82 P16	66,557	8	43 - 67	1,50-6,00	-	100	600
PST1655098	5,5 / 6,3 x 98 P16	72,273	8	54 - 83	1,50-6,00	-	100	600
PST1655115	5,5 / 6,3 x 115 P16	86,140	8	56 - 100	1,50-6,00	-	100	600



Tornillo autotaladrante de cabeza hexagonal para panel sándwich

PS

METAL



CÓDIGO	MEDIDA	€/100		ESPESOR MÁX. A FIJAR (MM)	CAPACIDAD DE TALADRO		
PSL55075	5,5 / 6,3 x 75	20,977	8	33 - 60	6,00-12,00	500	1.500
PSL55085	5,5 / 6,3 x 85	23,333	8	38 - 70	6,00-12,00	500	1.000
PSL55105	5,5 / 6,3 x 105	30,860	8	48 - 90	6,00-12,00	500	1.000
PSL55130	5,5 / 6,3 x 130	44,420	8	63 - 115	6,00-12,00	250	750
PSL55150	5,5 / 6,3 x 150	58,593	8	83 - 135	6,00-12,00	250	750
PSL55175	5,5 / 6,3 x 175	83,371	8	108 - 160	6,00-12,00	200	400
PSL55200	5,5 / 6,3 x 200	106,700	8	133 - 185	6,00-12,00	200	400
PSL55230	5,5 / 6,3 x 230	183,320	8	163 - 215	6,00-12,00	200	400

PS 5

Punta broca extra larga #5. Zincado



METAL



CÓDIGO	MEDIDA	€/100		ESPESOR MÁX. A FIJAR (MM)	CAPACIDAD DE TALADRO		
PSL1655075	5,5 / 6,3 x 75 P16	28,733	8	33 - 60	6,00-12,00	500	1.000
PSL1655085	5,5 / 6,3 x 85 P16	32,153	8	38 - 70	6,00-12,00	500	1.000
PSL1655105	5,5 / 6,3 x 105 P16	39,967	8	48 - 90	6,00-12,00	500	-
PSL1655130	5,5 / 6,3 x 130 P16	53,840	8	63 - 115	6,00-12,00	250	500
PSL1655150	5,5 / 6,3 x 150 P16	68,013	8	83 - 135	6,00-12,00	250	500
PSL1655175	5,5 / 6,3 x 175 P16	111,811	8	-	6,00-12,00	200	400
PSL1655200	5,5 / 6,3 x 200 P16	121,350	8	-	6,00-12,00	200	400
PSL1655230	5,5 / 6,3 x 230 P16	203,777	8	-	6,00-12,00	200	400

PS 5 + ARVUL

Punta broca extra larga #5 con arandela vulcanizada de acero-EPDM. Zincado



METAL



CÓDIGO	MEDIDA	€/100		ESPESOR MÁX. A FIJAR (MM)	CAPACIDAD DE TALADRO	
PSL1955255	5,5 / 6,3 x 255 P19	514,352	8	170 - 210	6,00-12,00	200
PSL1955285	5,5 / 6,3 x 285 P19	804,912	8	200 - 250	6,00-12,00	200

PS 5 + ARVUL A2

Punta broca extra larga #5 con recubrimiento ATLANTIS C4-M y arandela inoxidable A2



METAL



CÓDIGO	MEDIDA	€/100		ESPESOR MÁX. A FIJAR (MM)	CAPACIDAD DE TALADRO	UD. MIN. VENTA		
PSTL1655075	5,5 / 6,3 x 75 P16	63,827	8	33 - 60	6,00-12,00	-	100	1.200
PSTL1655085	5,5 / 6,3 x 85 P16	70,980	8	38 - 70	6,00-12,00	-	100	600
PSTL1655105	5,5 / 6,3 x 105 P16	87,957	8	48 - 90	6,00-12,00	-	100	600
PSTL1655130	5,5 / 6,3 x 130 P16	114,480	8	63 - 115	6,00-12,00	-	100	600

PST 5 + ARVUL ^{NEW}
A2

Tornillo con punta broca extra larga #5 con recubrimiento ATLANTIS C4-M y arandela inoxidable A2



FIBR

Tornillo autotaladrante para fibrocemento, montado con arandela paraguas



METAL



CÓDIGO	MEDIDA	€/100		ESPESOR MÁX. A FIJAR (MM)	CAPACIDAD DE TALADRO	
FI63110	6,3 x 110	93,545	8	75	6,00-12,00	250
FI63115	6,3 x 115	93,923	8	85	1,00-6,00	250
FI63120	6,3 x 120	95,228	8	85	6,00-12,00	250
FI63125	6,3 x 125	95,793	8	95	1,00-6,00	250
FI63130	6,3 x 130	101,726	8	95	6,00-12,00	250
FI63150	6,3 x 150	106,690	8	115	6,00-12,00	250
FI63160	6,3 x 160	125,603	8	125	6,00-12,00	250



TDR

Tornillo autorroscante de reparación



METAL



CÓDIGO	MEDIDA	€/100		
TDR2572025	7,2 x 25	42,923	500	1.000
TDR2572032	7,2 x 32	48,363	500	1.000
TDR2572038	7,2 x 38	52,577	250	750

ARVUL

Arandela vulcanizada de acero-EPDM



ARVUL

Recubrimiento ATLANTIS C2-M





METAL



CÓDIGO	MEDIDA	€/100	Ø INTERIOR ARANDELA		
ARANE14	P14	4,157	2.5	1.000	12.000
ARANE16	P16	4,750	2.7	1.000	6.000
ARANE18	P18	6,247	3.2	1.000	6.000
ARANE25	P25	11,157	3.3	500	3.000

Caja ventana

CÓDIGO	MEDIDA	€/CAJA	PCS 	CAJAS 
VARANE14	P14	5,078	100	8
VARANE16	P16	5,634	100	8
VARANE18	P18	7,391	100	8
VARANE25	P25	12,801	100	8



ARVUL A2

Inoxidable A2



INOXIDABLE



CÓDIGO	MEDIDA	€/100	Ø INTERIOR ARANDELA		
ARINO14	P14	11,587	2.5	1.000	12.000
ARINO16	P16	13,100	2.7	1.000	6.000
ARINO18	P18	16,487	3.2	1.000	6.000
ARINO25	P25	30,483	3.3	500	3.000
ARINOM30	P30	48,630	6.3	500	1.500



* ARINOM30: Especial instalaciones con anclaje MTH-A2, Ø6.



Arandela paraguas

ARPAR

METAL



ARPAR

Galvanizada



CÓDIGO	MEDIDA	€/100		
ARPAR25	P22	30,753	250	1.500

METAL



ARPAR A2

Inoxidable A2



CÓDIGO	MEDIDA	€/100		
ARPARA225	P22	41,150	250	1.500

Tapón de nylon de colores para tornillos con cabeza hexagonal

ATAP

METAL



CÓDIGO	COLOR	€/100			
ATAPO08AR	RAL 1001	7,557	8	1.000	2.000
ATAPO08BO	RAL 9002	7,557	8	1.000	2.000
ATAPO08BP	RAL 9010	7,557	8	1.000	2.000
ATAPO08BS	RAL 9003	7,557	8	1.000	2.000
ATAPO08GM	RAL 9006	7,557	8	1.000	2.000
ATAPO08NE	RAL 9005	7,557	8	1.000	2.000
ATAPO08PC	RAL 8004	7,557	8	1.000	2.000
ATAPO08RC	RAL 3003	7,557	8	1.000	2.000
ATAPO08RT	RAL 3011	7,557	8	1.000	2.000
ATAPO08RX	RAL 3009	7,557	8	1.000	2.000
ATAPO08VN	RAL 6028	7,557	8	1.000	2.000
ATAPO10AR	RAL 1001	7,557	10	1.000	2.000
ATAPO10BO	RAL 9002	7,557	10	1.000	2.000
ATAPO10BP	RAL 9010	7,557	10	1.000	2.000
ATAPO10BS	RAL 9003	7,557	10	1.000	2.000
ATAPO10GM	RAL 9006	7,557	10	1.000	2.000
ATAPO10NE	RAL 9005	7,557	10	1.000	2.000
ATAPO10PC	RAL 8004	7,557	10	1.000	2.000
ATAPO10RC	RAL 3003	7,557	10	1.000	2.000
ATAPO10RT	RAL 3011	7,557	10	1.000	2.000
ATAPO10RX	RAL 3009	7,557	10	1.000	2.000
ATAPO10VN	RAL 6028	7,557	10	1.000	2.000



TORNILLOS BROCA, ROSCA CHAPA Y PVC



DIN-7504-N Tornillo autotaladrante de cabeza alomada

DIN-7504-N HP Z

Zincado. Huella PH



Disponible en varios recubrimientos. Consulte precio y plazo de entrega.



CÓDIGO	MEDIDA	€/100	ESPESOR MÁX. AFUJAR(MM)	CAPACIDAD DE TALADRO			CÓDIGO	MEDIDA	€/100	ESPESOR MÁX. AFUJAR(MM)	CAPACIDAD DE TALADRO				
ABR3509	3,5 x 9,5	1,567	PH2	2,8	0,70-2,25	1.000	24.000	ABR4819	4,8 x 19	3,967	PH2	10,3	1,75-4,40	1.000	8.000
ABR3511	3,5 x 11	1,820	PH2	4,2	0,70-2,25	1.000	24.000	ABR4822	4,8 x 22	4,610	PH2	11,7	1,75-4,40	500	6.000
ABR3513	3,5 x 13	1,867	PH2	6,2	0,70-2,25	1.000	24.000	ABR4825	4,8 x 25	4,787	PH2	14,7	1,75-4,40	500	6.000
ABR3516	3,5 x 16	2,027	PH2	9,2	0,70-2,25	1.000	16.000	ABR4832	4,8 x 32	5,473	PH2	21,5	1,75-4,40	500	6.000
ABR3519	3,5 x 19	2,231	PH2	12,1	0,70-2,25	1.000	12.000	ABR4838	4,8 x 38	6,439	PH2	27,5	1,75-4,40	500	3.000
ABR3522	3,5 x 22	2,493	PH2	15,1	0,70-2,25	1.000	12.000	ABR4845	4,8 x 45	7,350	PH2	34,5	1,75-4,40	500	3.000
ABR3525	3,5 x 25	2,580	PH2	18,1	0,70-2,25	500	12.000	ABR4850	4,8 x 50	8,267	PH2	39,5	1,75-4,40	500	3.000
ABR3532	3,5 x 32	3,297	PH2	25,1	0,70-2,25	500	6.000	ABR4860	4,8 x 60	10,332	PH2	49,5	1,75-4,40	500	2.000
ABR3913	3,9 x 13	2,237	PH2	5,8	0,70-2,40	1.000	16.000	ABR4875	4,8 x 75	12,632	-	64,5	1,75-4,40	250	1.500
ABR3916	3,9 x 16	2,443	PH2	8,8	0,70-2,40	1.000	12.000	ABR4880	4,8 x 80	13,495	PH2	69,5	1,75-4,40	250	1.500
ABR3919	3,9 x 19	2,717	PH2	11,7	0,70-2,40	1.000	12.000	ABR4890	4,8 x 90	19,231	PH2	79,5	1,75-4,40	100	1.200
ABR3925	3,9 x 25	3,230	PH2	17,7	0,70-2,40	500	8.000	ABR4810	4,8 x 100	22,140	PH2	89,5	1,75-4,40	100	1.200
ABR3932	3,9 x 32	3,884	PH2	24,5	0,70-2,40	500	6.000	ABR4811	4,8 x 110	22,903	PH2	-	1,75-4,40	100	1.200
ABR4213	4,2 x 13	2,396	PH2	4,3	1,75-3,00	1.000	12.000	ABR4812	4,8 x 120	26,153	PH2	-	1,75-4,40	100	1.200
ABR4216	4,2 x 16	2,649	PH2	7,3	1,75-3,00	1.000	12.000	ABR5519	5,5 x 19	5,483	PH3	8,7	1,75-5,25	500	6.000
ABR4219	4,2 x 19	2,937	PH2	10,3	1,75-3,00	1.000	12.000	ABR5522	5,5 x 22	6,167	PH3	11,7	1,75-5,25	500	6.000
ABR4222	4,2 x 22	3,407	PH2	13,3	1,75-3,00	500	8.000	ABR5525	5,5 x 25	6,540	PH3	14,7	1,75-5,25	500	4.000
ABR4225	4,2 x 25	3,617	PH2	17,7	1,75-3,00	500	6.000	ABR5532	5,5 x 32	7,670	PH3	21,5	1,75-5,25	500	3.000
ABR4232	4,2 x 32	4,323	PH2	24,5	1,75-3,00	500	6.000	ABR5538	5,5 x 38	8,530	PH3	27,5	1,75-5,25	500	3.000
ABR4238	4,2 x 38	4,877	PH2	30,5	1,75-3,00	500	6.000	ABR5545	5,5 x 45	9,773	PH3	34,5	1,75-5,25	500	3.000
ABR4250	4,2 x 50	6,110	PH2	41	1,75-3,00	500	3.000	ABR5560	5,5 x 60	13,107	PH3	49,5	1,75-5,25	250	1.500
ABR4813	4,8 x 13	3,510	PH2	3,7	1,75-4,40	1.000	8.000	ABR5573	5,5 x 73	14,410	PH3	62,5	1,75-5,25	250	1.500
ABR4816	4,8 x 16	3,600	PH2	5,5	1,75-4,40	1.000	8.000								

Blíster

CÓDIGO	MEDIDA	€/BOLSA	PCS BOLSA	BOLSAS
BZABR3509	3,5 x 9,5	2,582	40	15
BZABR3513	3,5 x 13	2,582	40	15
BZABR3516	3,5 x 16	2,582	40	15
BZABR4213	4,2 x 13	2,582	40	15
BZABR4216	4,2 x 16	2,582	40	15
BZABR4219	4,2 x 19	2,582	40	15
BZABR4225	4,2 x 25	2,582	20	15
BZABR4232	4,2 x 32	2,582	20	15
BZABR4816	4,8 x 16	2,582	35	15
BZABR4819	4,8 x 19	2,582	35	15
BZABR4825	4,8 x 25	2,582	20	15
BZABR4832	4,8 x 32	2,582	20	15
BZABR4838	4,8 x 38	2,582	20	15
BZABR4845	4,8 x 45	2,582	20	15
BZABR4850	4,8 x 50	2,582	20	15
BZABR4860	4,8 x 60	2,582	20	15

Caja ventana

CÓDIGO	MEDIDA	€/CAJA	PCS CAJA	CAJAS
VABR3509	3,5 x 9,5	5,592	275	8
VABR3511	3,5 x 11	5,698	250	8
VABR3513	3,5 x 13	6,007	250	8
VABR3516	3,5 x 16	5,836	225	8
VABR3519	3,5 x 19	6,174	225	8
VABR3525	3,5 x 25	5,974	180	8
VABR3913	3,9 x 13	7,130	250	8
VABR3916	3,9 x 16	6,292	200	8
VABR3919	3,9 x 19	6,745	200	8
VABR3925	3,9 x 25	6,286	150	8
VABR3932	3,9 x 32	10,093	200	8
VABR4213	4,2 x 13	6,304	200	8
VABR4216	4,2 x 16	6,703	200	8
VABR4219	4,2 x 19	6,650	175	8
VABR4222	4,2 x 22	7,374	175	8
VABR4225	4,2 x 25	5,603	125	8
VABR4232	4,2 x 32	4,904	90	8
VABR4238	4,2 x 38	4,795	75	8
VABR4250	4,2 x 50	4,503	50	8
VABR4813	4,8 x 13	5,895	125	8
VABR4816	4,8 x 16	5,856	125	8
VABR4819	4,8 x 19	5,657	110	8
VABR4822	4,8 x 22	5,445	90	8
VABR4825	4,8 x 25	5,554	90	8
VABR4832	4,8 x 32	5,392	75	8
VABR4838	4,8 x 38	4,785	55	8
VABR4845	4,8 x 45	4,865	50	8
VABR4850	4,8 x 50	4,463	40	8
VABR4860	4,8 x 60	5,795	40	8
VABR4880	4,8 x 80	5,054	25	8
VABR5532	5,5 x 32	4,886	50	8



Tornillo autotaladrante de cabeza alomada

DIN-7504-N

INOXIDABLE



CÓDIGO	MEDIDA	€/100		ESPEJOR MÁX. A FIJAR (MM)	CAPACIDAD DE TALADRO		
ABRA23509	3,5 x 9,5	10,940	PH2	2,85	0,70-2,25	1.000	24.000
ABRA23513	3,5 x 13	12,960	PH2	6,2	0,70-2,25	500	12.000
ABRA23519	3,5 x 19	15,880	PH2	12,1	0,70-2,25	500	12.000
ABRA24213	4,2 x 13	15,180	PH2	4,3	1,75-3,00	500	12.000
ABRA24216	4,2 x 16	17,007	PH2	7,3	1,75-3,00	500	12.000
ABRA24219	4,2 x 19	18,097	PH2	10,3	1,75-3,00	500	12.000
ABRA24225	4,2 x 25	19,713	PH2	16,3	1,75-3,00	250	6.000
ABRA24816	4,8 x 16	23,813	PH2	5,5	1,75-4,40	250	6.000
ABRA24819	4,8 x 19	24,193	PH2	8,7	1,75-4,40	250	6.000
ABRA24825	4,8 x 25	26,880	PH2	14,7	1,75-4,40	250	6.000
ABRA24832	4,8 x 32	31,460	PH2	21,5	1,75-4,40	250	4.000
ABRA24838	4,8 x 38	34,443	PH2	27,5	1,75-4,40	250	3.000
ABRA24850	4,8 x 50	40,613	PH2	39,5	1,75-4,40	250	3.000

DIN-7504-N HP
A2

Inoxidable A2. Huella PH



METAL



CÓDIGO	MEDIDA	€/100		ESPEJOR MÁX. A FIJAR (MM)	CAPACIDAD DE TALADRO		
NBR3509	3,5 x 9,5	2,323	PH2	2,85	0,70-2,25	1.000	24.000
NBR3513	3,5 x 13	2,813	PH2	6,2	0,70-2,25	1.000	24.000
NBR3516	3,5 x 16	2,967	PH2	9,2	0,70-2,25	1.000	16.000
NBR3519	3,5 x 19	3,175	PH2	12,1	0,70-2,25	1.000	12.000
NBR4213	4,2 x 13	3,440	PH2	4,3	1,75-3,00	1.000	12.000
NBR4216	4,2 x 16	3,812	PH2	7,3	1,75-3,00	1.000	12.000
NBR4219	4,2 x 19	4,278	PH2	10,3	1,75-3,00	1.000	12.000
NBR4225	4,2 x 25	5,277	PH2	16,3	1,75-3,00	500	6.000
NBR4232	4,2 x 32	6,205	PH2	23	1,75-3,00	500	6.000
NBR4238	4,2 x 38	7,207	PH2	29	1,75-3,00	500	6.000
NBR4816	4,8 x 16	5,254	PH2	5,5	1,75-4,40	1.000	8.000
NBR4819	4,8 x 19	6,048	PH2	8,7	1,75-4,40	1.000	8.000
NBR4825	4,8 x 25	7,117	PH2	14,7	1,75-4,40	500	6.000
NBR4832	4,8 x 32	8,486	PH2	21,5	1,75-4,40	500	6.000
NBR4838	4,8 x 38	9,306	PH2	27,5	1,75-4,40	500	3.000
NBR4845	4,8 x 45	10,793	PH2	34,5	1,75-4,40	500	3.000
NBR4850	4,8 x 50	11,701	PH2	39,5	1,75-4,40	500	3.000

DIN-7504-N HP N

Zincado negro. Huella PH



Otras medidas, consultar precio y plazo

METAL



CÓDIGO	MEDIDA	€/100		ESPEJOR MÁX. A FIJAR (MM)	CAPACIDAD DE TALADRO		
ABR3509BLE	3,5 x 9,5	1,980	PH2	2,85	0,70-2,25	1.000	24.000
ABR3513BLE	3,5 x 13	4,380	PH2	6,2	0,70-2,25	1.000	24.000
ABR3516BLE	3,5 x 16	4,927	PH2	9,2	0,70-2,25	1.000	16.000
ABR4213BLE	4,2 x 13	5,727	PH2	4,3	1,75-3,00	1.000	12.000
ABR4216BLE	4,2 x 16	6,363	PH2	7,3	1,75-3,00	1.000	12.000
ABR4219BLE	4,2 x 19	6,387	PH2	10,3	1,75-3,00	1.000	12.000
ABR4825BLE	4,8 x 25	9,160	PH2	14,7	1,75-4,40	500	6.000

DIN-7504-N HP B

Pintado blanco. Huella PH



Otras medidas, consultar precio y plazo

DIN-7504-N Tornillo autotaladrante de cabeza alomada

DIN-7504-N HT

Zincado. Huella TX/OXBIT





TX

GRATIS - 1 punta en cada caja

METAL



CÓDIGO	MEDIDA	€/100		ESPESOR MÁX. A FIJAR (MM)	CAPACIDAD DE TALADRO		
ABRT3509	3,5 x 9,5	1,811	Tx20/OXBIT20	2,8	0,70-2,25	1.000	24.000
ABRT3513	3,5 x 13	2,128	Tx20/OXBIT20	6,2	0,70-2,25	1.000	24.000
ABRT3516	3,5 x 16	2,371	Tx20/OXBIT20	9,2	0,70-2,25	1.000	16.000
ABRT3519	3,5 x 19	2,610	Tx20/OXBIT20	12,1	0,70-2,25	1.000	12.000
ABRT3913	3,9 x 13	2,621	Tx20/OXBIT20	5,8	0,70-2,40	1.000	16.000
ABRT3916	3,9 x 16	2,841	Tx20/OXBIT20	8,8	0,70-2,40	1.000	12.000
ABRT3919	3,9 x 19	3,124	Tx20/OXBIT20	11,7	0,70-2,40	1.000	12.000
ABRT3925	3,9 x 25	3,715	Tx20/OXBIT20	17,7	0,70-2,40	500	8.000
ABRT4213	4,2 x 13	2,731	Tx20/OXBIT20	4,3	1,75-3,00	1.000	12.000
ABRT4216	4,2 x 16	3,047	Tx20/OXBIT20	7,3	1,75-3,00	1.000	12.000
ABRT4219	4,2 x 19	3,428	Tx20/OXBIT20	10,3	1,75-3,00	1.000	12.000
ABRT4225	4,2 x 25	4,159	Tx20/OXBIT20	17,7	1,75-3,00	500	6.000
ABRT4232	4,2 x 32	4,972	Tx20/OXBIT20	24,5	1,75-3,00	500	6.000
ABRT4238	4,2 x 38	5,608	Tx20/OXBIT20	30,5	1,75-3,00	500	6.000
ABRT4250	4,2 x 50	7,093	Tx20/OXBIT20	41	1,75-3,00	500	3.000
ABRT4813	4,8 x 13	4,037	Tx25/OXBIT25	3,7	1,75-4,40	1.000	8.000
ABRT4816	4,8 x 16	4,212	Tx25/OXBIT25	5,5	1,75-4,40	1.000	8.000
ABRT4819	4,8 x 19	4,562	Tx25/OXBIT25	10,3	1,75-4,40	1.000	8.000
ABRT4825	4,8 x 25	5,561	Tx25/OXBIT25	14,7	1,75-4,40	500	6.000
ABRT4832	4,8 x 32	6,359	Tx25/OXBIT25	21,5	1,75-4,40	500	6.000
ABRT4838	4,8 x 38	7,533	Tx25/OXBIT25	27,5	1,75-4,40	500	3.000
ABRT4845	4,8 x 45	8,672	Tx25/OXBIT25	34,5	1,75-4,40	500	3.000
ABRT4850	4,8 x 50	9,507	Tx25/OXBIT25	39,5	1,75-4,40	500	3.000
ABRT4860	4,8 x 60	11,882	Tx25/OXBIT25	49,5	1,75-4,40	500	2.000
ABRT4875	4,8 x 75	14,527	-	64,5	1,75-4,40	250	1.500
ABRT4880	4,8 x 80	15,519	Tx25/OXBIT25	69,5	1,75-4,40	250	1.500
ABRT4890	4,8 x 90	22,115	Tx25/OXBIT25	79,5	1,75-4,40	100	1.200
ABRT4810	4,8 x 100	25,723	Tx25/OXBIT25	89,5	1,75-4,40	100	1.200
ABRT4811	4,8 x 110	27,166	Tx25/OXBIT25	-	1,75-4,40	100	1.200
ABRT4812	4,8 x 120	30,660	Tx25/OXBIT25	-	1,75-4,40	100	1.200
ABRT5519	5,5 x 19	6,499	Tx25/OXBIT25	8,7	1,75-5,25	500	6.000
ABRT5525	5,5 x 25	7,521	Tx25/OXBIT25	14,7	1,75-5,25	500	4.000
ABRT5532	5,5 x 32	8,821	Tx25/OXBIT25	21,5	1,75-5,25	500	3.000
ABRT5538	5,5 x 38	10,117	Tx25/OXBIT25	27,5	1,75-5,25	500	3.000
ABRT5560	5,5 x 60	15,221	Tx25/OXBIT25	49,5	1,75-5,25	250	1.500
ABRT5573	5,5 x 73	16,572	Tx25/OXBIT25	62,5	1,75-5,25	250	1.500

DIN-7504-N HC



Zincado. Huella cuadrada



Cuadrada

METAL



CÓDIGO	MEDIDA	€/100		ESPESOR MÁX. A FIJAR (MM)	CAPACIDAD DE TALADRO		
ABRC3509	3,5 x 9,5	1,780	PC1	2,85	0,70-2,25	1.000	24.000
ABRC3513	3,5 x 13	2,080	PC1	6,2	0,70-2,25	1.000	24.000
ABRC3516	3,5 x 16	2,263	PC1	9,2	0,70-2,25	1.000	16.000
ABRC3519	3,5 x 19	2,483	PC1	12,1	0,70-2,25	1.000	12.000
ABRC3913	3,9 x 13	2,490	PC1	5,8	0,70-2,40	1.000	16.000
ABRC3916	3,9 x 16	2,730	PC1	8,8	0,70-2,40	1.000	12.000
ABRC3919	3,9 x 19	3,033	PC1	11,7	0,70-2,40	1.000	12.000
ABRC3925	3,9 x 25	3,600	PC1	17,7	0,70-2,40	500	8.000
ABRC3938	3,9 x 38	4,020	PC1	30,5	0,70-2,40	500	6.000
ABRC4213	4,2 x 13	2,697	PC2	4,3	1,75-3,00	1.000	12.000
ABRC4216	4,2 x 16	2,957	PC2	7,3	1,75-3,00	1.000	12.000
ABRC4219	4,2 x 19	3,347	PC2	10,3	1,75-3,00	1.000	12.000
ABRC4225	4,2 x 25	3,947	PC2	16,3	1,75-3,00	500	6.000
ABRC4232	4,2 x 32	4,627	PC2	23	1,75-3,00	500	6.000
ABRC4238	4,2 x 38	5,440	PC2	29	1,75-3,00	500	6.000
ABRC4816	4,8 x 16	4,017	PC2	5,5	1,75-4,40	1.000	8.000
ABRC4819	4,8 x 19	4,430	PC2	8,7	1,75-4,40	1.000	8.000
ABRC4825	4,8 x 25	5,340	PC2	14,7	1,75-4,40	500	6.000
ABRC4832	4,8 x 32	6,110	PC2	21,5	1,75-4,40	500	6.000
ABRC4838	4,8 x 38	7,183	PC2	27,5	1,75-4,40	500	3.000
ABRC4845	4,8 x 45	8,200	PC2	34,5	1,75-4,40	500	3.000
ABRC4850	4,8 x 50	9,223	PC2	39,5	1,75-4,40	500	3.000
ABRC4860	4,8 x 60	11,763	PC2	49,5	1,75-4,40	500	2.000
ABRC4880	4,8 x 80	15,360	PC2	69,5	1,75-4,40	250	1.500
ABRC4890	4,8 x 90	21,887	PC2	79,5	1,75-4,40	100	1.200
ABRC4810	4,8 x 100	24,700	PC2	89,5	1,75-4,40	100	1.200
ABRC5525	5,5 x 25	7,297	PC3	13	1,75-5,25	500	4.000
ABRC5573	5,5 x 73	16,073	PC3	61	1,75-5,25	250	1.500



Tornillo autotaladrante con cabeza avellanada

DIN-7504-P

METAL



DIN-7504-P HP Z

Zincado. Huella PH

CÓDIGO	MEDIDA	€/100		ESPESOR MÁX. A FIJAR (MM)	CAPACIDAD DE TALADRO		
ABP3509	3,5 x 9,5	1,960	PH2	2,85	0,70-2,25	1.000	24.000
ABP3511	3,5 x 11	1,593	PH2	4,2	0,70-2,25	1.000	24.000
ABP3513	3,5 x 13	1,711	PH2	6,2	0,70-2,25	1.000	24.000
ABP3516	3,5 x 16	1,819	PH2	9,2	0,70-2,25	1.000	24.000
ABP3519	3,5 x 19	2,036	PH2	12,1	0,70-2,25	1.000	12.000
ABP3522	3,5 x 22	2,383	PH2	15,1	0,70-2,25	1.000	12.000
ABP3525	3,5 x 25	2,517	PH2	18,1	0,70-2,25	500	12.000
ABP3913	3,9 x 13	1,890	PH2	5,8	0,70-2,40	1.000	24.000
ABP3916	3,9 x 16	2,160	PH2	8,8	0,70-2,40	1.000	12.000
ABP3919	3,9 x 19	2,423	PH2	11,7	0,70-2,40	1.000	12.000
ABP3922	3,9 x 22	2,747	PH2	14,7	0,70-2,40	500	12.000
ABP3925	3,9 x 25	2,810	PH2	17,7	0,70-2,40	500	12.000
ABP3932	3,9 x 32	3,380	PH2	24,5	0,70-2,40	500	6.000
ABP3938	3,9 x 38	3,943	PH2	30,5	0,70-2,40	500	6.000
ABP4213	4,2 x 13	2,200	PH2	4,3	1,75-3,00	1.000	12.000
ABP4216	4,2 x 16	2,380	PH2	7,3	1,75-3,00	1.000	12.000
ABP4219	4,2 x 19	2,703	PH2	10,3	1,75-3,00	1.000	12.000
ABP4222	4,2 x 22	3,050	PH2	13,3	1,75-3,00	500	12.000
ABP4225	4,2 x 25	3,320	PH2	16,3	1,75-3,00	500	6.000
ABP4232	4,2 x 32	3,813	PH2	23	1,75-3,00	500	6.000
ABP4238	4,2 x 38	4,553	PH2	29	1,75-3,00	500	6.000
ABP4813	4,8 x 13	3,080	PH2	3,7	1,75-4,40	1.000	12.000
ABP4816	4,8 x 16	3,250	PH2	5,5	1,75-4,40	1.000	12.000
ABP4819	4,8 x 19	3,563	PH2	8,7	1,75-4,40	1.000	8.000
ABP4825	4,8 x 25	4,053	PH2	14,7	1,75-4,40	500	6.000
ABP4832	4,8 x 32	5,193	PH2	21,5	1,75-4,40	500	6.000
ABP4838	4,8 x 38	5,867	PH2	27,5	1,75-4,40	500	3.000
ABP4850	4,8 x 50	7,640	PH2	39,5	1,75-4,40	500	3.000
ABP5519	5,5 x 19	4,883	PH3	8,7	1,75-5,25	500	6.000
ABP5525	5,5 x 25	5,640	PH3	14,7	1,75-5,25	500	6.000
ABP5532	5,5 x 32	6,837	PH3	21,5	1,75-5,25	500	3.000
ABP5538	5,5 x 38	7,940	PH3	27,5	1,75-5,25	500	3.000
ABP5550	5,5 x 50	10,023	PH3	39,5	1,75-5,25	500	3.000



Blíster

CÓDIGO	MEDIDA	€/BOLSA	PCS	BOLSAS
BZABP3513	3,5 x 13	2,582	40	20
BZABP3516	3,5 x 16	2,582	40	20
BZABP4219	4,2 x 19	2,582	40	20
BZABP4225	4,2 x 25	2,582	20	20
BZABP4232	4,2 x 32	2,582	20	20

Caja ventana

CÓDIGO	MEDIDA	€/CAJA	PCS	CAJAS
VABP3513	3,5 x 13	5,384	250	8
VABP3516	3,5 x 16	5,354	225	8
VABP3519	3,5 x 19	5,593	200	8
VABP3525	3,5 x 25	5,779	180	8
VABP3913	3,9 x 13	5,317	200	8
VABP3916	3,9 x 16	5,981	200	8
VABP3919	3,9 x 19	5,796	175	8
VABP3925	3,9 x 25	5,413	150	8
VABP3938	3,9 x 38	5,090	100	8
VABP4213	4,2 x 13	5,438	175	8
VABP4216	4,2 x 16	5,415	175	8
VABP4219	4,2 x 19	5,864	175	8
VABP4225	4,2 x 25	5,282	125	8
VABP4232	4,2 x 32	4,631	90	8
VABP4238	4,2 x 38	4,513	75	8
VABP4816	4,8 x 16	5,697	125	8
VABP4819	4,8 x 19	5,009	100	8
VABP4825	4,8 x 25	4,666	90	8
VABP4832	4,8 x 32	4,985	75	8
VABP4838	4,8 x 38	5,811	75	8
VABP5532	5,5 x 32	4,528	50	8

DIN-7504-P Tornillo autotaladrante con cabeza avellanada

DIN-7504-P HP N

Zincado negro. Huella PH





CÓDIGO	MEDIDA	€/100		ESPESOR MÁX. A FIJAR (MM)	CAPACIDAD DE TALADRO		
NBP3513	3,5 x 13	2,502	PH2	6,2	0,70-2,25	1.000	24.000
NBP3516	3,5 x 16	2,759	PH2	9,2	0,70-2,25	1.000	24.000
NBP3519	3,5 x 19	3,153	PH2	12,1	0,70-2,25	1.000	12.000
NBP3525	3,5 x 25	3,910	PH2	18,1	0,70-2,25	500	12.000
NBP4216	4,2 x 16	3,537	PH2	7,3	1,75-3,00	1.000	12.000
NBP4219	4,2 x 19	4,025	PH2	10,3	1,75-3,00	1.000	12.000
NBP4225	4,2 x 25	4,900	PH2	16,3	1,75-3,00	500	6.000
NBP4232	4,2 x 32	5,943	PH2	23	1,75-3,00	500	6.000
NBP4238	4,2 x 38	7,513	PH2	29	1,75-3,00	500	6.000
NBP4825	4,8 x 25	6,457	PH2	14,7	1,75-4,40	500	6.000
NBP4832	4,8 x 32	7,954	PH2	21,5	1,75-4,40	500	6.000
NBP4838	4,8 x 38	9,251	PH2	27,5	1,75-4,40	500	3.000
NBP4850	4,8 x 50	11,443	PH2	39,5	1,75-4,40	500	3.000

DIN-7504-P HT Z

Zincado. Huella TX/OXBIT



CÓDIGO	MEDIDA	€/100		ESPESOR MÁX. A FIJAR (MM)	CAPACIDAD DE TALADRO		
ABPT3513	3,5 x 13	2,138	Tx15/OXBIT15	6,2	0,70-2,25	1.000	24.000
ABPT3516	3,5 x 16	2,274	Tx15/OXBIT15	9,2	0,70-2,25	1.000	24.000
ABPT3519	3,5 x 19	2,545	Tx15/OXBIT15	12,1	0,70-2,25	1.000	12.000
ABPT3913	3,9 x 13	2,363	Tx15/OXBIT15	5,8	0,70-2,40	1.000	24.000
ABPT3916	3,9 x 16	2,808	Tx15/OXBIT15	8,8	0,70-2,40	1.000	12.000
ABPT4213	4,2 x 13	2,794	Tx20/OXBIT20	4,3	1,75-3,00	1.000	12.000
ABPT4216	4,2 x 16	2,975	Tx20/OXBIT20	7,3	1,75-3,00	1.000	12.000
ABPT4219	4,2 x 19	3,433	Tx20/OXBIT20	10,3	1,75-3,00	1.000	12.000
ABPT4225	4,2 x 25	4,216	Tx20/OXBIT20	16,3	1,75-3,00	500	6.000
ABPT4232	4,2 x 32	4,843	Tx20/OXBIT20	23	1,75-3,00	500	6.000
ABPT4819	4,8 x 19	4,525	Tx25/OXBIT25	8,7	1,75-4,40	1.000	8.000
ABPT4825	4,8 x 25	5,188	Tx25/OXBIT25	14,7	1,75-4,40	500	6.000
ABPT4832	4,8 x 32	6,596	Tx25/OXBIT25	21,5	1,75-4,40	500	6.000
ABPT4838	4,8 x 38	7,451	Tx25/OXBIT25	27,5	1,75-4,40	500	3.000
ABPT4850	4,8 x 50	9,703	Tx25/OXBIT25	39,5	1,75-4,40	500	3.000

GRATIS - 1 punta en cada caja



ABA

Tornillo autotaladrante con broca de dos alas, cabeza avellanada

ABA

Zincado. Huella PH



CÓDIGO	MEDIDA	€/100		ESPESOR MÁX. A FIJAR (MM)	CAPACIDAD DE TALADRO		
ABA4832	4,8 x 32	5,573	PH2	16	1,75 - 4,00	500	6.000
ABA4838	4,8 x 38	6,283	PH2	22	1,75 - 4,00	500	6.000
ABA4845	4,8 x 45	7,437	PH2	29	1,75 - 4,00	500	3.000
ABA4850	4,8 x 50	8,457	PH2	34	1,75 - 4,00	500	3.000
ABA5538	5,5 x 38	9,413	PH2	19	1,75 - 5,00	500	3.000
ABA5545	5,5 x 45	10,053	PH2	26	1,75 - 5,00	500	3.000
ABA5555	5,5 x 55	12,000	PH2	36	1,75 - 5,00	500	3.000
ABA5565	5,5 x 65	13,880	PH2	46	1,75 - 5,00	500	2.000
ABA6360	6,3 x 60	18,127	PH3	40	2,50 - 6,00	250	1.500
ABA6370	6,3 x 70	20,630	PH3	50	2,50 - 6,00	250	1.500
ABA6385	6,3 x 85	25,993	PH3	65	2,50 - 6,00	250	1.000

Disponible en varios recubrimientos. Consulte precio y plazo de entrega.



Tornillo autotaladrante con broca de dos alas, cabeza avellanada

ABA



ATA

Zincado. Huella TX

CÓDIGO	MEDIDA	€/100		ESPESOR MÁX. A FIJAR (MM)	CAPACIDAD DE TALADRO		
ATA4832	4,8 x 32	5,847	TX25	16	1,75 - 4,00	500	6.000
ATA4838	4,8 x 38	6,770	TX25	22	1,75 - 4,00	500	6.000
ATA4845	4,8 x 45	7,600	TX25	29	1,75 - 4,00	500	3.000
ATA4850	4,8 x 50	9,107	TX25	34	1,75 - 4,00	500	3.000
ATA5538	5,5 x 38	10,140	TX25	19	1,75 - 5,00	500	3.000
ATA5545	5,5 x 45	10,557	TX25	26	1,75 - 5,00	500	3.000
ATA5550	5,5 x 50	12,033	TX25	31	1,75 - 5,00	500	3.000
ATA5555	5,5 x 55	12,317	TX25	36	1,75 - 5,00	500	2.000
ATA5565	5,5 x 65	15,297	TX25	46	1,75 - 5,00	500	2.000
ATA6350	6,3 x 50	17,583	TX30	30	2,50 - 6,00	500	2.000
ATA6360	6,3 x 60	19,540	TX30	40	2,50 - 6,00	250	1.500
ATA6370	6,3 x 70	22,240	TX30	50	2,50 - 6,00	250	1.500
ATA6385	6,3 x 85	27,283	TX30	65	2,50 - 6,00	250	1.000
ATA6310	6,3 x 100	39,313	TX30	80	2,50 - 6,00	250	750

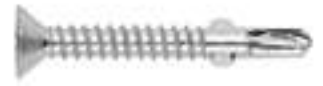

Disponible en varios recubrimientos. Consulte precio y plazo de entrega.



TX

Tornillo punta broca, cabeza remache y huella PH

RS



RS

Zincado

CÓDIGO	MEDIDA	€/100		ESPESOR MÁX. A FIJAR (MM)	CAPACIDAD DE TALADRO		
RSZ3509	3,5 x 9	3,303	PH2	2,8	0,75 - 2,25	500	22.500
RSZ3513	3,5 x 13	3,697	PH2	6,2	0,75 - 2,25	500	22.500
RSZ3516	3,5 x 16	4,087	PH2	9,2	0,75 - 2,25	500	22.500
RSZ4213	4,2 x 13	4,637	PH2	4,3	1,75 - 3	500	22.500
RSZ4216	4,2 x 16	4,933	PH2	7,3	1,75 - 3	500	12.000
RSZ4219	4,2 x 19	5,680	PH2	10,3	1,75 - 3	500	12.000
RSZ4225	4,2 x 25	7,227	PH2	16,3	1,75 - 3	250	6.000
RSZ4232	4,2 x 32	7,717	PH2	23	1,75 - 3	250	6.000
RSZ4813	4,8 x 13	6,940	PH2	3,7	1,75 - 4,4	500	12.000
RSZ4816	4,8 x 16	7,303	PH2	5,5	1,75 - 4,4	250	11.250
RSZ4819	4,8 x 19	8,273	PH2	8,7	1,75 - 4,4	250	11.250
RSZ4825	4,8 x 25	10,047	PH2	14,7	1,75 - 4,4	250	6.000
RSZ4832	4,8 x 32	10,483	PH2	21,5	1,75 - 4,4	250	3.000
RSZ4838	4,8 x 38	12,197	PH2	27,5	1,75 - 4,4	250	3.000



Disponible en varios recubrimientos. Consulte precio y plazo de entrega.

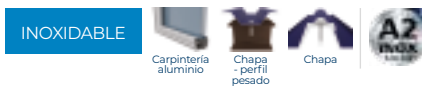

RS-A2

Inoxidable A2

CÓDIGO	MEDIDA	€/100		ESPESOR MÁX. A FIJAR (MM)	CAPACIDAD DE TALADRO		
RSA23509	3,5 x 9,5	14,270	PH2	2,8	0,75 - 2,25	500	22.500
RSA24213	4,2 x 13	20,557	PH2	7,3	1,75 - 3	500	22.500
RSA24216	4,2 x 16	21,897	PH2	10,3	1,75 - 3	500	12.000
RSA24219	4,2 x 19	23,220	PH2	16,3	1,75 - 3	500	12.000
RSA24816	4,8 x 16	28,733	PH2	5,5	1,75 - 4,4	250	11.250
RSA24819	4,8 x 19	30,790	PH2	8,7	1,75 - 4,4	250	11.250
RSA24825	4,8 x 25	34,737	PH2	14,7	1,75 - 4,4	250	6.000



BCP

Tornillo autotaladrante de cabeza extraplana y huella PH

BCP Z

Zincado. Huella PH

METAL



CÓDIGO	MEDIDA	€/100		ESPEJOR MÁX. A FIJAR (MM)	CAPACIDAD DE TALADRO		
BCPZ4214	4,2 x 14	2,527	PH2	6	0,70-2,00	500	12.000
BCPZ4223	4,2 x 23	3,737	PH2	15	0,70-2,00	500	12.000



Disponible en varios recubrimientos. Consulte precio y plazo de entrega.

BCP A2

Inoxidable A2. Huella PH

INOXIDABLE



CÓDIGO	MEDIDA	€/100		ESPEJOR MÁX. A FIJAR (MM)	CAPACIDAD DE TALADRO		
BCPA24214	4,2 x 14	20,323	PH2	6	0,70-2,00	500	12.000
BCPA24223	4,2 x 23	28,050	PH2	6	-	500	12.000

BCP N

Zincado negro. Huella PH

METAL



CÓDIGO	MEDIDA	€/100		ESPEJOR MÁX. A FIJAR (MM)	CAPACIDAD DE TALADRO		
BCPN4214	4,2 x 14	3,616	PH2	6	0,70-2,00	500	12.000
BCPN4223	4,2 x 23	5,403	PH2	15	0,70-2,00	500	12.000

BCP B

Pintado blanco. Huella PH

METAL



CÓDIGO	MEDIDA	€/100		ESPEJOR MÁX. A FIJAR (MM)	CAPACIDAD DE TALADRO		
BCPB4214	4,2 x 14	5,336	PH2	6	0,70-2,00	500	12.000
BCPB4223	4,2 x 23	7,868	PH2	15	0,70-2,00	500	12.000

BCP CB

Cabeza lacada blanca. Huella PH

METAL



CÓDIGO	MEDIDA	€/100		ESPEJOR MÁX. A FIJAR (MM)	CAPACIDAD DE TALADRO		
BCPZ4214BL	4,2 x 14	9,820	PH2	6	0,70-2,00	500	22.500
BCPZ4223BL	4,2 x 23	12,591	PH2	15	0,70-2,00	500	12.000



Tornillo autotaladrante de cabeza alomada baja y arandela estampada

TAE

METAL



CÓDIGO	MEDIDA	€/100		ESPESOR MÁX. A FIJAR (MM)	CAPACIDAD DE TALADRO		
TAEZ4213	4,2 x 13	4,047	PH2	4,3	0,75 - 2,50	500	12.000
TAEZ4216	4,2 x 16	4,467	PH2	7,3	0,75 - 2,50	500	8.000
TAEZ4219	4,2 x 19	4,983	PH2	10,3	0,75 - 2,50	500	6.000
TAEZ4225	4,2 x 25	5,253	PH2	16,3	0,75 - 2,50	500	6.000
TAEZ4232	4,2 x 32	6,574	PH2	23	0,75 - 2,50	500	6.000

TAEZ

Zincado. Huella PH



Disponible en varios recubrimientos. Consulte precio y plazo de entrega.

METAL



CÓDIGO	MEDIDA	€/100		ESPESOR MÁX. A FIJAR (MM)	CAPACIDAD DE TALADRO		
TAEN4213	4,2 x 13	6,226	PH2	4,3	0,75 - 2,50	500	12.000
TAEN4216	4,2 x 16	7,000	PH2	7,3	0,75 - 2,50	500	8.000
TAEN4219	4,2 x 19	7,772	PH2	10,3	0,75 - 2,50	500	6.000
TAEN4225	4,2 x 25	8,949	PH2	16,3	0,75 - 2,50	500	6.000
TAEN4232	4,2 x 32	10,568	PH2	23	0,75 - 2,50	500	6.000

TAEN

Zincado negro. Huella PH



Tornillo rosca chapa con cabeza alomada

DIN-7981 H

METAL



CÓDIGO	MEDIDA	€/100			
T813509BLE	3,5 x 9,5	3,452	PH2	1.000	24.000
T814213BLE	4,2 x 13	5,488	PH2	500	12.000
T814225BLE	4,2 x 25	8,601	PH2	250	6.000

DIN-7981 HP B

Pintado blanco. Huella PH



METAL



CÓDIGO	MEDIDA	€/100			
TZN812909	2,9 x 9,5	2,167	PH1	1.000	30.000
TZN813513	3,5 x 13	2,860	PH2	500	15.000
TZN813516	3,5 x 16	3,500	PH2	500	12.000
TZN813519	3,5 x 19	3,973	PH2	500	12.000
TZN813525	3,5 x 25	5,157	PH2	250	6.000
TZN814216	4,2 x 16	4,573	PH2	500	12.000
TZN814219	4,2 x 19	4,950	PH2	500	8.000
TZN814225	4,2 x 25	5,657	PH2	250	6.000
TZN814232	4,2 x 32	7,800	PH2	250	6.000
TZN814238	4,2 x 38	8,833	PH2	250	3.000
TZN814816	4,8 x 16	6,373	PH2	250	6.000
TZN814819	4,8 x 19	7,027	PH2	250	6.000
TZN814822	4,8 x 22	7,470	PH2	250	6.000
TZN814825	4,8 x 25	7,413	PH2	250	6.000
TZN814838	4,8 x 38	10,907	PH2	250	3.000
TZN814850	4,8 x 50	14,823	PH2	250	3.000

DIN-7981 HP N

Zincado negro. Huella PH



DIN-7981 H Tornillo rosca chapa con cabeza alomada

DIN-7981 HP Z

Zincado. Huella PH



CÓDIGO	MEDIDA	€/100				CÓDIGO	MEDIDA	€/100			
T8129006	2,9 x 6,5	1,497	PH1	1.000	45.000	T8148025	4,8 x 25	5,015	PH2	250	6.000
T8129009	2,9 x 9,5	1,547	PH1	1.000	30.000	T8148032	4,8 x 32	5,807	PH2	250	4.000
T8129013	2,9 x 13	1,560	PH1	1.000	24.000	T8148038	4,8 x 38	6,791	PH2	250	3.000
T8129016	2,9 x 16	1,782	PH1	1.000	24.000	T8148045	4,8 x 45	7,883	PH2	250	3.000
T8129019	2,9 x 19	1,893	PH1	1.000	24.000	T8148050	4,8 x 50	8,580	PH2	250	3.000
T8129022	2,9 x 22	2,267	PH1	1.000	12.000	T8148060	4,8 x 60	10,810	PH2	250	1.500
T8129025	2,9 x 25	2,443	PH1	500	12.000	T8148070	4,8 x 70	12,847	PH2	100	1.200
T8135006	3,5 x 6,5	1,560	PH2	1.000	24.000	T8148080	4,8 x 80	15,770	PH2	100	1.200
T8135009	3,5 x 9,5	1,603	PH2	1.000	24.000	T8148090	4,8 x 90	18,822	PH2	100	1.200
T8135013	3,5 x 13	1,907	PH2	500	15.000	T8148100	4,8 x 100	20,930	PH2	100	1.200
T8135016	3,5 x 16	2,166	PH2	500	12.000	T8148110	4,8 x 110	26,262	PH2	100	1.200
T8135019	3,5 x 19	2,407	PH2	500	12.000	T8148120	4,8 x 120	31,006	PH2	100	1.200
T8135025	3,5 x 25	3,040	PH2	250	6.000	T8155013	5,5 x 13	5,173	PH3	250	6.000
T8135032	3,5 x 32	3,787	PH2	250	6.000	T8155016	5,5 x 16	5,338	PH3	250	6.000
T8139009	3,9 x 9,5	2,071	PH2	500	15.000	T8155019	5,5 x 19	5,913	PH3	250	6.000
T8139013	3,9 x 13	2,330	PH2	500	12.000	T8155022	5,5 x 22	6,716	PH3	250	4.000
T8139016	3,9 x 16	2,487	PH2	500	12.000	T8155025	5,5 x 25	6,913	PH3	250	4.000
T8139019	3,9 x 19	2,897	PH2	500	12.000	T8155032	5,5 x 32	7,931	PH3	250	3.000
T8139022	3,9 x 22	3,227	PH2	250	6.000	T8155038	5,5 x 38	9,043	PH3	250	3.000
T8139025	3,9 x 25	3,577	PH2	250	6.000	T8155045	5,5 x 45	10,657	PH3	250	3.000
T8139032	3,9 x 32	4,037	PH2	250	6.000	T8155050	5,5 x 50	11,307	PH3	250	1.500
T8139038	3,9 x 38	4,727	PH2	250	6.000	T8155060	5,5 x 60	14,050	PH3	100	1.200
T8139045	3,9 x 45	5,593	PH2	250	3.000	T8155070	5,5 x 70	15,597	PH3	100	1.200
T8139050	3,9 x 50	6,207	PH2	250	3.000	T8155080	5,5 x 80	20,034	PH3	100	1.200
T8142009	4,2 x 9,5	2,373	PH2	500	12.000	T8155090	5,5 x 90	23,536	PH3	100	1.200
T8142013	4,2 x 13	2,560	PH2	500	12.000	T8155100	5,5 x 100	27,501	PH3	100	1.200
T8142016	4,2 x 16	3,012	PH2	500	12.000	T8155110	5,5 x 110	31,693	PH3	100	1.200
T8142019	4,2 x 19	3,167	PH2	500	8.000	T8155120	5,5 x 120	38,643	PH3	100	1.200
T8142022	4,2 x 22	3,828	PH2	250	6.000	T8163016	6,3 x 16	7,340	PH3	250	4.000
T8142025	4,2 x 25	3,947	PH2	250	6.000	T8163019	6,3 x 19	8,030	PH3	250	3.000
T8142032	4,2 x 32	4,617	PH2	250	6.000	T8163022	6,3 x 22	8,420	PH3	250	3.000
T8142038	4,2 x 38	5,403	PH2	250	3.000	T8163025	6,3 x 25	8,940	PH3	250	3.000
T8142045	4,2 x 45	5,821	PH2	250	3.000	T8163032	6,3 x 32	10,987	PH3	250	3.000
T8142050	4,2 x 50	6,540	PH2	250	3.000	T8163038	6,3 x 38	12,453	PH3	250	1.500
T8142060	4,2 x 60	8,657	PH2	250	3.000	T8163045	6,3 x 45	14,576	PH3	250	1.500
T8142070	4,2 x 70	9,727	PH2	250	1.500	T8163050	6,3 x 50	16,247	PH3	250	1.500
T8142080	4,2 x 80	11,580	PH2	250	1.500	T8163060	6,3 x 60	19,755	PH3	100	1.200
T8142090	4,2 x 90	15,737	PH2	250	1.500	T8163070	6,3 x 70	21,343	PH3	100	1.200
T8148009	4,8 x 9,5	3,207	PH2	500	12.000	T8163080	6,3 x 80	27,192	PH3	100	1.200
T8148013	4,8 x 13	3,330	PH2	500	8.000	T8163090	6,3 x 90	33,817	PH3	50	600
T8148016	4,8 x 16	3,930	PH2	250	6.000	T8163100	6,3 x 100	35,840	PH3	50	600
T8148019	4,8 x 19	4,515	PH2	250	6.000	T8163110	6,3 x 110	39,718	PH3	50	600
T8148022	4,8 x 22	5,037	PH2	250	6.000	T8163120	6,3 x 120	42,612	PH3	50	600

Blíster

CÓDIGO	MEDIDA	€/BOLSA	PCS	BOLSAS
BZT8135013	3,5 x 13	2,040	20	20
BZT8135016	3,5 x 16	2,040	20	20
BZT8135019	3,5 x 19	2,040	20	20
BZT8135009	3,5 x 9,5	2,040	40	20
BZT8139013	2,9 x 13	2,040	20	20
BZT8139016	2,9 x 16	2,040	20	20
BZT8139019	2,9 x 19	2,040	20	20
BZT8139025	2,9 x 25	2,040	10	20
BZT8139032	3,9 x 32	2,040	10	20
BZT8142013	4,2 x 13	2,040	20	20
BZT8142016	4,2 x 16	2,040	20	20
BZT8142019	4,2 x 19	2,040	20	20
BZT8142025	4,2 x 25	2,040	10	20
BZT8142032	4,2 x 32	2,040	10	20
BZT8142038	4,2 x 38	2,040	10	20
BZT8142009	4,2 x 9,5	2,040	20	20
BZT8148016	4,8 x 16	2,040	10	20
BZT8148019	4,8 x 19	2,040	10	20
BZT8148025	4,8 x 25	2,040	10	20
BZT8148032	4,8 x 32	2,040	10	20
BZT8148038	4,8 x 38	2,040	10	20
BZT8148050	4,8 x 50	2,040	10	20
BZT8148060	4,8 x 60	2,040	10	20
BZT8155025	3,5 x 25	2,040	10	20
BZT8155032	3,5 x 32	2,040	10	20
BZT8155038	3,5 x 38	2,040	10	20
BZT8155050	3,5 x 50	2,040	10	20

Caja ventana

CÓDIGO	MEDIDA	€/CAJA	PCS	CAJAS
VT8135009	3,5 x 9,5	5,386	250	8
VT8135013	3,5 x 13	5,551	200	8
VT8135016	3,5 x 16	6,116	200	8
VT8135019	3,5 x 19	6,658	200	8
VT8135025	3,5 x 25	8,430	200	8
VT8139009	2,9 x 9,5	5,756	200	8
VT8139013	2,9 x 13	6,435	200	8
VT8139016	2,9 x 16	6,877	200	8
VT8139019	2,9 x 19	6,219	150	8
VT8139022	2,9 x 22	4,794	100	8
VT8139025	2,9 x 25	5,171	100	8
VT8142009	4,2 x 9,5	6,732	200	8
VT8142013	4,2 x 13	6,846	200	8
VT8142016	4,2 x 16	8,160	200	8
VT8142019	4,2 x 19	6,482	150	8
VT8142022	4,2 x 22	5,364	100	8
VT8142025	4,2 x 25	5,184	100	8
VT8142032	4,2 x 32	6,118	100	8
VT8142038	4,2 x 38	5,403	75	8
VT8142050	4,2 x 50	4,885	50	8
VT8148009	4,8 x 9,5	6,791	150	8
VT8148013	4,8 x 13	7,074	150	8
VT8148016	4,8 x 16	5,161	100	8
VT8148019	4,8 x 19	5,864	100	8
VT8148025	4,8 x 25	6,968	100	8
VT8148032	4,8 x 32	7,648	100	8
VT8148038	4,8 x 38	9,669	100	8
VT8148045	4,8 x 45	7,782	70	8
VT8148050	4,8 x 50	5,958	50	8
VT8148060	4,8 x 60	7,503	50	8
VT8148070	4,8 x 70	7,142	40	8
VT8148080	4,8 x 80	5,879	25	8
VT8155019	3,5 x 19	8,162	100	8
VT8155025	3,5 x 25	8,757	90	8
VT8155032	3,5 x 32	10,912	100	8
VT8155038	3,5 x 38	9,341	75	8



Tornillo rosca chapa con cabeza avellanada

DIN-7982 H



CÓDIGO	MEDIDA	€/100			
T8229006	2,9 x 6,5	1,786	PH1	1.000	45.000
T8229009	2,9 x 9,5	1,417	PH1	1.000	45.000
T8229013	2,9 x 13	1,430	PH1	1.000	45.000
T8229016	2,9 x 16	1,583	PH1	1.000	24.000
T8229019	2,9 x 19	1,793	PH1	1.000	24.000
T8229022	2,9 x 22	1,777	PH1	1.000	24.000
T8229025	2,9 x 25	2,267	PH1	500	12.000
T8235009	3,5 x 9,5	1,587	PH2	1.000	24.000
T8235013	3,5 x 13	1,783	PH2	500	22.500
T8235016	3,5 x 16	2,000	PH2	500	22.500
T8235019	3,5 x 19	2,210	PH2	500	12.000
T8235022	3,5 x 22	2,407	PH2	500	12.000
T8235025	3,5 x 25	2,888	PH2	250	11.250
T8235032	3,5 x 32	3,507	PH2	250	6.000
T8235038	3,5 x 38	3,985	PH2	250	6.000
T8239009	3,9 x 9,5	1,907	PH2	500	22.500
T8239013	3,9 x 13	2,037	PH2	500	12.000
T8239016	3,9 x 16	2,360	PH2	500	12.000
T8239019	3,9 x 19	2,603	PH2	500	12.000
T8239022	3,9 x 22	3,301	PH2	250	6.000
T8239025	3,9 x 25	3,527	PH2	250	6.000
T8239032	3,9 x 32	4,270	PH2	250	6.000
T8239038	3,9 x 38	4,667	PH2	250	6.000
T8239045	3,9 x 45	5,303	PH2	250	3.000
T8239050	3,9 x 50	6,102	PH2	250	3.000
T8242013	4,2 x 13	2,283	PH2	500	15.000
T8242016	4,2 x 16	2,537	PH2	500	12.000
T8242019	4,2 x 19	2,963	PH2	500	12.000
T8242022	4,2 x 22	3,573	PH2	250	11.250
T8242025	4,2 x 25	3,757	PH2	250	6.000
T8242032	4,2 x 32	4,413	PH2	250	6.000
T8242038	4,2 x 38	5,203	PH2	250	6.000
T8242045	4,2 x 45	6,013	PH2	250	3.000

CÓDIGO	MEDIDA	€/100			
T8242050	4,2 x 50	6,589	PH2	250	3.000
T8242060	4,2 x 60	8,527	PH2	250	3.000
T8242070	4,2 x 70	10,103	PH2	250	3.000
T8248013	4,8 x 13	3,067	PH2	500	12.000
T8248016	4,8 x 16	3,580	PH2	250	11.250
T8248019	4,8 x 19	4,185	PH2	250	6.000
T8248022	4,8 x 22	4,607	PH2	250	6.000
T8248025	4,8 x 25	5,227	PH2	250	6.000
T8248032	4,8 x 32	5,720	PH2	250	6.000
T8248038	4,8 x 38	7,027	PH2	250	3.000
T8248045	4,8 x 45	7,930	PH2	250	3.000
T8248050	4,8 x 50	9,473	PH2	250	3.000
T8248060	4,8 x 60	10,571	PH2	250	1.500
T8248070	4,8 x 70	13,168	PH2	100	2.400
T8255013	5,5 x 13	4,221	PH3	250	7.500
T8255016	5,5 x 16	4,730	PH3	250	6.000
T8255019	5,5 x 19	5,432	PH3	250	6.000
T8255022	5,5 x 22	6,328	PH3	250	6.000
T8255025	5,5 x 25	6,817	PH3	250	6.000
T8255032	5,5 x 32	8,034	PH3	250	3.000
T8255038	5,5 x 38	8,747	PH3	250	3.000
T8255045	5,5 x 45	10,437	PH3	250	3.000
T8255050	5,5 x 50	13,047	PH3	250	1.500
T8255060	5,5 x 60	14,847	PH3	100	1.200
T8255070	5,5 x 70	16,697	PH3	100	1.200
T8263025	6,3 x 25	9,700	PH3	250	3.000
T8263032	6,3 x 32	11,508	PH3	250	3.000
T8263038	6,3 x 38	12,403	PH3	250	3.000
T8263045	6,3 x 45	12,364	PH3	250	1.500
T8263050	6,3 x 50	14,676	PH3	250	1.500
T8263060	6,3 x 60	20,496	PH3	100	1.200
T8263070	6,3 x 70	21,434	PH3	100	1.200



Disponible en diferentes colores



Disponible en varios recubrimientos. Consulte precio y plazo de entrega.

Blíster

CÓDIGO	MEDIDA	€/BOLSA	PCS BOLSA	BOLSAS
BZT8242019	4,2 x 19	2,040	20	20
BZT8242025	4,2 x 25	2,040	10	20
BZT8248025	4,8 x 25	2,040	10	20
BZT8248038	4,8 x 38	2,040	10	20

Caja ventana

CÓDIGO	MEDIDA	€/CAJA	PCS CAJA	CAJAS
VT8235009	3,5 x 9,5	5,361	250	8
VT8235013	3,5 x 13	4,901	200	8
VT8235016	3,5 x 16	5,382	200	8
VT8235019	3,5 x 19	5,962	200	8
VT8235025	3,5 x 25	4,121	100	8
VT8239016	2,9 x 16	6,188	200	8
VT8239019	2,9 x 19	6,931	200	8
VT8239022	2,9 x 22	4,810	100	8
VT8239025	2,9 x 25	5,025	100	8
VT8242016	4,2 x 16	6,594	200	8
VT8242019	4,2 x 19	7,212	200	8
VT8242025	4,2 x 25	4,827	100	8
VT8242032	4,2 x 32	5,882	100	8
VT8248019	4,8 x 19	5,526	100	8
VT8248025	4,8 x 25	6,577	100	8
VT8248032	4,8 x 32	7,006	95	8
VT8248038	4,8 x 38	7,014	80	8
VT8255032	3,5 x 32	7,894	75	8
VT8255038	3,5 x 38	8,134	70	8

T-CO

TORNILLERÍA LACADA EN COLORES

PERSONALIZA TU TORNILLERÍA CON NUESTRO SERVICIO DE LACADO

ESCOGE ENTRE UNA AMPLIA GAMA DE TORNILLOS
QUE PUEDES LACAR EN MÁS DE 60 COLORES.

154 DIN-7504-K



156 DIN-7504-K RE



166 DIN-7504-N HP



171 DIN-7981 HP



159 AUE



175 DIN-7982 HP



¿POR QUÉ ELEGIR TORNILLERÍA LACADA?



Acabado impecable
y resistente



Elige entre una
variedad de colores



Para proyectos con
tornillería visible



T-CO

TORNILLERÍA LACADA EN COLORES

LACADO DE TORNILLOS COMPLETO



DIÁMETRO	LONGITUD	CANTIDAD MÍNIMA
Min. 2,9 mm - Max. 5,5 mm	Min. 6,5 mm - Max. 32 mm	15 Kgs (*)

(*) Por medida y color

Colores disponibles

	RAL 3005 Rojo vino		RAL 9005 Negro intenso
	RAL 5009 Azul azur		RAL 9010 Blanco puro
	RAL 6005 Verde musgo		

LACADO DE TORNILLOS SOLO CABEZA



DIÁMETRO	LONGITUD	CANTIDAD MÍNIMA
Min. 3,9 mm - Max. 6,3 mm	Min. 13 mm - Max. 90 mm	(*)

(*) Consultar cantidad mínima

Colores disponibles

	RAL 1000 Crema Bidasoa		RAL 5005 Azul señales		RAL 7016 Gris antracita		RAL 8017 Chocolate
	RAL 1001 Beige		RAL 5008 Azul grisáceo		RAL 7021 Gris negruzco		RAL 8019 Pardo grisáceo
	RAL 1007 Amarillo narciso		RAL 5009 Azul azur		RAL 7022 Gris sombra		RAL 8024 Pardo beige
	RAL 1011 Beige pardo		RAL 5010 Azul genciana		RAL 7024 Gris grafito		RAL 8025 Pardo pálido
	RAL 1015 Marfil claro		RAL 5011 Azul acero		RAL 7032 Gris guijarro		RAL 9002 Blanco grisáceo
	RAL 3002 Rojo carmin		RAL 5019 Azul capri		RAL 7033 Gris cemento		RAL 9003 Blanco señales
	RAL 3003 Rojo rubí		RAL 6005 Verde musgo		RAL 7034 Gris amarillento		RAL 9005 Negro intenso
	RAL 3004 Rojo púrpura		RAL 6009 Verde abeto		RAL 7035 Gris luminoso		RAL 9006 Aluminio blanco
	RAL 3005 Rojo vino		RAL 6021 Verde pálido		RAL 7040 Gris ventana		RAL 9007 Aluminio gris
	RAL 3009 Rojo óxido		RAL 6022 Verde oliva		RAL 7045 Gris tele		RAL 9010 Negro puro
	RAL 3011 Rojo pardo		RAL 6028 Verde pino		RAL 8003 Pardo arcilla		RAL 9011 Negro grafito
	RAL 3020 Rojo tráfico		RAL 7011 Gris hierro		RAL 8004 Pardo cobre		RAL 9016 Blanco tráfico
	RAL 5002 Azul ultramar		RAL 7012 Gris basalto		RAL 8012 Pardo rojo		RAL 9018 Blanco papiro
	RAL 5003 Azul zafiro		RAL 7015 Gris pizarra		RAL 8014 Sepia		

CONSULTA PRECIOS Y PLAZOS DE ENTREGA

CPC

Tornillo rosca chapa con cabeza extraplana

CP-Z

Zincado. Huella PH



Disponible en varios recubrimientos. Consulte precio y plazo de entrega.



CÓDIGO	MEDIDA	€/100		ESPEJOR MÁX. A FIJAR (MM)		
TCPZ4213	4,2 x 13	2,543	PH2	6	500	12.000
TCPZ4222	4,2 x 22	3,653	PH2	15	500	12.000
TCPZ4232	4,2 x 32	4,870	PH2	25	500	6.000

CP-A2

Inoxidable A2. Huella PH





CÓDIGO	MEDIDA	€/100		ESPEJOR MÁX. A FIJAR (MM)		
TCPA24213	4,2 x 13	9,134	PH2	6	500	12.000
TCPA24222	4,2 x 22	15,680	PH2	15	500	12.000
TCPA24232	4,2 x 32	19,130	PH2	25	500	6.000

CP-B

Pintado blanco. Huella PH





CÓDIGO	MEDIDA	€/100		ESPEJOR MÁX. A FIJAR (MM)		
TCPB4213	4,2 x 13	5,110	PH2	6	500	12.000
TCPB4222	4,2 x 22	7,558	PH2	15	500	12.000
TCPB4232	4,2 x 32	10,337	PH2	25	500	6.000

CP-N

Zincado negro. Huella PH



CÓDIGO	MEDIDA	€/100		ESPEJOR MÁX. A FIJAR (MM)		
TCPN4213	4,2 x 13	3,707	PH2	6	500	12.000
TCPN4222	4,2 x 22	5,409	PH2	15	500	12.000
TCPN4232	4,2 x 32	7,575	PH2	25	500	6.000



Tornillos para carpintería de PVC

PVC

METAL



PVC-10 Z

Zincado. Diámetro de cabeza 7,5 mm



Disponible en varios recubrimientos. Consulte precio y plazo de entrega.

METAL



PVC-20 B

Bicromatado. Diámetro de cabeza 7 mm



METAL



PVC-20 Z

Zincado. Diámetro de cabeza 7 mm



Disponible en varios recubrimientos. Consulte precio y plazo de entrega.

METAL



PVC-30

Bicromatado. Tornillo de reparación, diámetro de cabeza de 7,5 mm



METAL



PVC-40 B

Bicromatado. Punta broca piloto



CÓDIGO	MEDIDA	€/100			
P103925Z	3,9 x 25	3,453	PH2	1.000	12.000
P103930Z	3,9 x 30	3,891	PH2	1.000	12.000
P103938Z	3,9 x 38	5,198	PH2	500	6.000
P103945Z	3,9 x 45	5,740	PH2	500	3.000

CÓDIGO	MEDIDA	€/100			
P204325	4,3 x 25	3,440	PH2	1.000	12.000
P204330	4,3 x 30	4,000	PH2	1.000	6.000
P204338	4,3 x 38	4,887	PH2	500	6.000
P204345	4,3 x 45	6,030	PH2	500	3.000
P204355	4,3 x 55	6,920	PH2	500	3.000

CÓDIGO	MEDIDA	€/100			
P204316Z	4,3 x 16	2,863	PH2	1.000	24.000
P204319Z	4,3 x 19	3,030	PH2	1.000	12.000
P204322Z	4,3 x 22	3,310	PH2	1.000	12.000
P204325Z	4,3 x 25	3,440	PH2	1.000	12.000
P204330Z	4,3 x 30	4,000	PH2	1.000	6.000
P204338Z	4,3 x 38	4,887	PH2	500	6.000
P204345Z	4,3 x 45	6,030	PH2	500	3.000
P204355Z	4,3 x 55	6,920	PH2	500	3.000

CÓDIGO	MEDIDA	€/100			
P304825	4,8 x 25	6,103	PH2	500	6.000
P304838	4,8 x 38	7,333	PH2	500	6.000

CÓDIGO	MEDIDA	€/100			
P403916	3,9 x 16	2,955	PH2	1.000	16.000
P403919	3,9 x 19	3,243	PH2	1.000	12.000
P403925	3,9 x 25	3,899	PH2	1.000	12.000
P403932	3,9 x 32	4,917	PH2	1.000	6.000
P403938	3,9 x 38	5,727	PH2	500	6.000

PVC

Tornillos para carpintería de PVC

PVC-40 Z



Zincado. Punta broca piloto



 Disponible en varios recubrimientos. Consulte precio y plazo de entrega.

METAL



CÓDIGO	MEDIDA	€/100			
P403913Z	3,9 x 13	2,430	PH2	1.000	24.000
P403916Z	3,9 x 16	2,955	PH2	1.000	16.000
P403919Z	3,9 x 19	3,243	PH2	1.000	12.000
P403925Z	3,9 x 25	3,899	PH2	1.000	12.000
P403932Z	3,9 x 32	4,917	PH2	1.000	6.000
P403938Z	3,9 x 38	5,727	PH2	500	6.000

PVC-50 B



Bicromatado. Rosca métrica, punta broca



 Disponible en varios recubrimientos. Consulte precio y plazo de entrega.

METAL



CÓDIGO	MEDIDA	€/100			
P50M416	M4 x 16	3,263	PH2	1.000	16.000
P50M419	M4 x 19	3,827	PH2	1.000	12.000
P50M425	M4 x 25	4,777	PH2	1.000	12.000
P50M432	M4 x 32	5,467	PH2	1.000	6.000
P50M438	M4 x 38	7,307	PH2	500	6.000

PVC-50 Z



Zincado. Rosca métrica, punta broca



 Disponible en varios recubrimientos. Consulte precio y plazo de entrega.

METAL



CÓDIGO	MEDIDA	€/100			
P50M413Z	M4 x 13	3,078	PH2	1.000	24.000
P50M416Z	M4 x 16	3,263	PH2	1.000	16.000
P50M419Z	M4 x 19	3,827	PH2	1.000	12.000
P50M425Z	M4 x 25	4,777	PH2	1.000	12.000
P50M432Z	M4 x 32	5,467	PH2	1.000	6.000

PVC-70



Bicromatado. Cabeza especial para tapón



 Disponible en varios recubrimientos. Consulte precio y plazo de entrega.

METAL



CÓDIGO	MEDIDA	€/100			
P704855	4,8 x 55	11,447	PH2	500	3.000
P704865	4,8 x 65	15,093	PH2	500	2.000
P704880	4,8 x 80	20,560	PH2	250	1.500
P704895	4,8 x 95	29,697	PH2	250	1.500

PVC-70 TP

Tapón de nylon: blanco y negro para tornillo PVC-70



METAL





CÓDIGO	DIÁMETRO	COLOR	€/100		
P70TPBL	13	BLANCO	3,920	1.000	24.000
P70TPNG	13	NEGRO	3,920	1.000	24.000

Tornillos para carpintería de PVC

PVC





CÓDIGO	MEDIDA	€/100			
P903510	3,5 x 10	3,630	PH2	1.000	24.000
P904017	4 x 17	5,316	PH2	1.000	12.000

PVC-90

Bicromatado. Cabeza alomada baja con arandela



CÓDIGO	MEDIDA	€/100			
P100VEK	VEKAPLAST 4,8 x 10	18,403	PH2	500	6.000



PVC-VEK

VEKAPLAST con cabeza especial



Disponible en varios recubrimientos. Consulte precio y plazo de entrega.



CÓDIGO	MEDIDA	€/100			
P100VEK13	VEKAPLAST 4 x 10	17,037	PH2	500	12.000

PVC-VEK 13

VEKAPLAST con cabeza especial y broca





CÓDIGO	MEDIDA	€/100		
P100VEK10	VEKAPLAST 4 x 10	15,247	PH2	500

PVC-VEK 10

VEKAPLAST con cabeza especial



CÓDIGO	MEDIDA	€/100			
P100KOM10	KOMMERLING 5,5 x 10	24,107	PH2	500	6.000

PVC-KOM 10

KOMMERLING con cabeza especial



Disponible en varios recubrimientos. Consulte precio y plazo de entrega.



TORNILLOS PARA MADERA



TEX

Tirafondo de alto rendimiento

TEX-BP

Bicromatado. Huella PZ



CÓDIGO	MEDIDA	€/100	+	UD. MIN. VENTA		
••TEXBP25010	2,5 x 10	1,239	PZ1	2.000	1.000	45.000
••TEXBP25012	2,5 x 12	1,291	PZ1	2.000	1.000	45.000
••TEXBP25016	2,5 x 16	1,449	PZ1	2.000	1.000	45.000
••TEXBP25020	2,5 x 20	1,607	PZ1	2.000	1.000	24.000
••TEXBP25025	2,5 x 25	1,789	PZ1	2.000	1.000	24.000
••TEXBP30012	3 x 12	1,555	PZ1	2.000	1.000	45.000
••TEXBP30015	3 x 15	1,682	PZ1	2.000	1.000	24.000
••TEXBP30016	3 x 16	1,970	PZ1	2.000	1.000	24.000
••TEXBP30020	3 x 20	2,039	PZ1	2.000	1.000	24.000
••TEXBP30025	3 x 25	2,438	PZ1	2.000	1.000	24.000
••TEXBP30030	3 x 30	2,813	PZ1	2.000	1.000	12.000
••TEXBP30035	3 x 35	2,845	PZ1	2.000	1.000	12.000
••TEXBP30040	3 x 40	3,221	PZ1	2.000	1.000	6.000
••TEXBP30045	3 x 45	4,020	PZ1	1.000	500	6.000
••TEXBP35010	3,5 x 10	1,861	PZ2	2.000	1.000	24.000
••TEXBP35012	3,5 x 12	2,048	PZ2	2.000	1.000	24.000
••TEXBP35015	3,5 x 15	2,066	PZ2	2.000	1.000	24.000
••TEXBP35016	3,5 x 16	2,324	PZ2	2.000	1.000	24.000
••TEXBP35020	3,5 x 20	2,328	PZ2	2.000	1.000	24.000
••TEXBP35025	3,5 x 25	2,939	PZ2	2.000	1.000	12.000
••TEXBP35030	3,5 x 30	3,468	PZ2	2.000	1.000	12.000
••TEXBP35035	3,5 x 35	3,546	PZ2	2.000	1.000	12.000
••TEXBP35040	3,5 x 40	4,296	PZ2	1.000	500	6.000
••TEXBP35045	3,5 x 45	4,800	PZ2	1.000	500	6.000
••TEXBP35050	3,5 x 50	5,548	PZ2	1.000	500	6.000
••TEXBP40012	4 x 12	2,376	PZ2	2.000	1.000	24.000
••TEXBP40015	4 x 15	2,412	PZ2	2.000	1.000	24.000
••TEXBP40016	4 x 16	2,750	PZ2	2.000	1.000	24.000
••TEXBP40020	4 x 20	3,096	PZ2	2.000	1.000	12.000
••TEXBP40025	4 x 25	3,499	PZ2	2.000	1.000	12.000
••TEXBP40030	4 x 30	3,882	PZ2	2.000	1.000	6.000
••TEXBP40035	4 x 35	4,691	PZ2	1.000	500	6.000
••TEXBP40040	4 x 40	5,198	PZ2	1.000	500	3.000
••TEXBP40045	4 x 45	6,087	PZ2	1.000	500	3.000
••TEXBP40050	4 x 50	6,514	PZ2	1.000	500	3.000
••TEXBP40055	4 x 55	7,048	PZ2	500	250	1.500
••TEXBP40060	4 x 60	8,208	PZ2	500	250	3.000
••TEXBP40070	4 x 70	9,545	PZ2	500	250	1.500
••TEXBP40080	4 x 80	9,607	PZ2	500	250	1.500
••TEXBP45016	4,5 x 16	3,010	PZ2	2.000	1.000	12.000
••TEXBP45020	4,5 x 20	4,219	PZ2	2.000	1.000	12.000
••TEXBP45025	4,5 x 25	4,465	PZ2	2.000	1.000	12.000
••TEXBP45030	4,5 x 30	4,925	PZ2	1.000	500	6.000
••TEXBP45035	4,5 x 35	5,923	PZ2	1.000	500	6.000
••TEXBP45040	4,5 x 40	6,403	PZ2	1.000	500	3.000
••TEXBP45045	4,5 x 45	7,366	PZ2	500	250	3.000
••TEXBP45050	4,5 x 50	7,597	PZ2	500	250	3.000
••TEXBP45060	4,5 x 60	9,738	PZ2	500	250	1.500
••TEXBP45070	4,5 x 70	11,194	PZ2	500	250	1.500
••TEXBP45080	4,5 x 80	14,752	PZ2	200	100	1.200
••TEXBP50025	5 x 25	5,147	PZ2	2.000	1.000	6.000
••TEXBP50030	5 x 30	6,639	PZ2	1.000	500	6.000
••TEXBP50035	5 x 35	6,892	PZ2	1.000	500	6.000
••TEXBP50040	5 x 40	8,161	PZ2	1.000	500	6.000
••TEXBP50045	5 x 45	8,998	PZ2	500	250	3.000
••TEXBP50050	5 x 50	9,528	PZ2	500	250	3.000
••TEXBP50060	5 x 60	12,354	PZ2	500	250	1.500
••TEXBP50070	5 x 70	14,537	PZ2	400	200	1.200
••TEXBP50080	5 x 80	17,937	PZ2	200	100	1.200
••TEXBP50090	5 x 90	19,464	PZ2	200	100	1.200
••TEXBP50100	5 x 100	21,909	PZ2	200	100	1.200
••TEXBP50110	5 x 110	24,847	PZ2	200	100	1.200
••TEXBP50120	5 x 120	28,445	PZ2	200	100	1.200
••TEXBP60040	6 x 40	12,407	PZ3	500	250	3.000
••TEXBP60045	6 x 45	13,941	PZ3	500	250	3.000
••TEXBP60050	6 x 50	15,799	PZ3	500	250	1.500
••TEXBP60060	6 x 60	18,258	PZ3	500	250	1.500
••TEXBP60070	6 x 70	20,438	PZ3	200	100	1.200
••TEXBP60080	6 x 80	22,146	PZ3	200	100	1.200
••TEXBP60090	6 x 90	25,784	PZ3	200	100	600
••TEXBP60100	6 x 100	26,369	PZ3	200	100	600
••TEXBP60110	6 x 110	36,856	PZ3	200	100	600
••TEXBP60120	6 x 120	40,482	PZ3	200	100	600

• Medidas sin homologar
• Hasta fin de existencias

Blíster

CÓDIGO	MEDIDA	€/BOLSA	PCS	BOLSAS
BZTXBP30016	3 x 16	2,582	40	20
BZTXBP30020	3 x 20	2,582	40	20
BZTXBP30025	3 x 25	2,582	40	20
BZTXBP30030	3 x 30	2,582	40	20
BZTXBP35016	3,5 x 16	2,582	40	20
BZTXBP35020	3,5 x 20	2,582	40	20
BZTXBP35025	3,5 x 25	2,582	40	20
BZTXBP35030	3,5 x 30	2,582	40	20
BZTXBP35035	3,5 x 35	2,582	20	20
BZTXBP35040	3,5 x 40	2,582	20	20
BZTXBP35050	3,5 x 50	2,582	20	20
BZTXBP40025	4 x 25	2,582	40	20
BZTXBP40030	4 x 30	2,582	20	20
BZTXBP40035	4 x 35	2,582	20	20
BZTXBP40040	4 x 40	2,582	20	20
BZTXBP40045	4 x 45	2,582	20	20
BZTXBP40050	4 x 50	2,582	10	20
BZTXBP40060	4 x 60	2,582	10	20
BZTXBP45030	4,5 x 30	2,582	20	20
BZTXBP45035	4,5 x 35	2,582	20	20
BZTXBP45040	4,5 x 40	2,582	20	20
BZTXBP45045	4,5 x 45	2,582	10	20
BZTXBP45050	4,5 x 50	2,582	10	20
BZTXBP45060	4,5 x 60	2,582	10	20
BZTXBP45070	4,5 x 70	2,582	10	20
BZTXBP50030	5 x 30	2,582	10	20
BZTXBP50035	5 x 35	2,582	10	20
BZTXBP50040	5 x 40	2,582	10	20
BZTXBP50050	5 x 50	2,582	10	20
BZTXBP50060	5 x 60	2,582	10	20
BZTXBP50070	5 x 70	2,582	4	20
BZTXBP50080	5 x 80	2,582	4	20
BZTXBP60050	6 x 50	2,582	10	20
BZTXBP60060	6 x 60	2,582	10	20
BZTXBP60070	6 x 70	2,582	4	20
BZTXBP60080	6 x 80	2,582	4	20

Caja ventana

CÓDIGO	MEDIDA	€/CAJA	PCS	CAJAS
VTEXBP30016	3 x 16	4,880	200	8
VTEXBP30020	3 x 20	5,248	200	8
VTEXBP30025	3 x 25	5,300	200	8
VTEXBP30030	3 x 30	6,040	170	8
VTEXBP30040	3 x 40	5,825	120	8
VTEXBP35016	3,5 x 16	5,604	200	8
VTEXBP35020	3,5 x 20	6,285	200	8
VTEXBP35025	3,5 x 25	5,996	170	8
VTEXBP35030	3,5 x 30	6,122	150	8
VTEXBP35035	3,5 x 35	5,130	100	8
VTEXBP35040	3,5 x 40	3,970	75	8
VTEXBP35050	3,5 x 50	6,417	75	8
VTEXBP40025	4 x 25	5,577	125	8
VTEXBP40030	4 x 30	5,174	100	8
VTEXBP40035	4 x 35	4,048	75	8
VTEXBP40040	4 x 40	4,384	75	8
VTEXBP40045	4 x 45	5,646	75	8
VTEXBP40050	4 x 50	3,850	50	8
VTEXBP40060	4 x 60	5,392	50	8
VTEXBP45030	4,5 x 30	6,194	100	8
VTEXBP45035	4,5 x 35	5,463	75	8
VTEXBP45040	4,5 x 40	5,379	75	8
VTEXBP45045	4,5 x 45	4,844	50	8
VTEXBP45050	4,5 x 50	4,655	50	8
VTEXBP45060	4,5 x 60	6,475	50	8
VTEXBP45070	4,5 x 70	7,711	50	8
VTEXBP50030	5 x 30	5,903	75	8
VTEXBP50035	5 x 35	5,981	75	8
VTEXBP50040	5 x 40	5,035	50	8
VTEXBP50050	5 x 50	5,609	50	8
VTEXBP50060	5 x 60	3,657	25	8
VTEXBP50070	5 x 70	4,671	25	8
VTEXBP50080	5 x 80	5,206	25	8
VTEXBP50090	5 x 90	5,881	25	8
VTEXBP60050	6 x 50	7,766	40	8
VTEXBP60060	6 x 60	6,357	30	8
VTEXBP60070	6 x 70	5,110	20	8
VTEXBP60080	6 x 80	6,040	20	8

Tirafondo de alto rendimiento

TEX

MADERA



TEX-ZP

Zincado. Huella PZ

CÓDIGO	MEDIDA	€/100		UD. MIN. VENTA		
•TEXZP25010	2,5 x 10	1,239	PZ1	2.000	1.000	45.000
•TEXZP25012	2,5 x 12	1,291	PZ1	2.000	1.000	45.000
•TEXZP25016	2,5 x 16	1,449	PZ1	2.000	1.000	45.000
•TEXZP25020	2,5 x 20	1,561	PZ1	2.000	1.000	45.000
•TEXZP25025	2,5 x 25	1,789	PZ1	2.000	1.000	45.000
•TEXZP30010	3 x 10	1,427	PZ1	2.000	1.000	45.000
•TEXZP30012	3 x 12	1,555	PZ1	2.000	1.000	45.000
•TEXZP30015	3 x 15	1,682	PZ1	2.000	1.000	24.000
•TEXZP30016	3 x 16	1,970	PZ1	2.000	1.000	24.000
•TEXZP30020	3 x 20	2,039	PZ1	2.000	1.000	24.000
•TEXZP30025	3 x 25	2,438	PZ1	2.000	1.000	24.000
•TEXZP30030	3 x 30	2,813	PZ1	2.000	1.000	12.000
•TEXZP30035	3 x 35	2,845	PZ1	2.000	1.000	12.000
•TEXZP30040	3 x 40	3,221	PZ1	2.000	1.000	6.000
•TEXZP30045	3 x 45	4,020	PZ1	1.000	500	6.000
•TEXZP35010	3,5 x 10	1,861	PZ2	2.000	1.000	24.000
•TEXZP35012	3,5 x 12	2,048	PZ2	2.000	1.000	24.000
•TEXZP35015	3,5 x 15	2,066	PZ2	2.000	1.000	24.000
•TEXZP35016	3,5 x 16	2,324	PZ2	2.000	1.000	24.000
•TEXZP35020	3,5 x 20	2,328	PZ2	2.000	1.000	24.000
•TEXZP35025	3,5 x 25	2,939	PZ2	2.000	1.000	12.000
•TEXZP35030	3,5 x 30	3,468	PZ2	2.000	1.000	12.000
•TEXZP35035	3,5 x 35	3,546	PZ2	2.000	1.000	12.000
•TEXZP35040	3,5 x 40	4,296	PZ2	1.000	500	6.000
•TEXZP35045	3,5 x 45	4,800	PZ2	1.000	500	6.000
•TEXZP35050	3,5 x 50	5,548	PZ2	1.000	500	6.000
•TEXZP40012	4 x 12	2,376	PZ2	2.000	1.000	24.000
•TEXZP40015	4 x 15	2,412	PZ2	2.000	1.000	24.000
•TEXZP40016	4 x 16	2,750	PZ2	2.000	1.000	24.000
•TEXZP40020	4 x 20	3,096	PZ2	2.000	1.000	12.000
•TEXZP40025	4 x 25	3,499	PZ2	2.000	1.000	12.000
•TEXZP40030	4 x 30	3,882	PZ2	2.000	1.000	6.000
•TEXZP40035	4 x 35	4,691	PZ2	1.000	500	6.000
•TEXZP40040	4 x 40	5,198	PZ2	1.000	500	3.000
•TEXZP40045	4 x 45	6,087	PZ2	1.000	500	3.000
•TEXZP40050	4 x 50	6,514	PZ2	1.000	500	3.000
•TEXZP40055	4 x 55	7,048	PZ2	500	250	3.000
•TEXZP40060	4 x 60	8,208	PZ2	500	250	3.000

CÓDIGO	MEDIDA	€/100		UD. MIN. VENTA		
•TEXZP40070	4 x 70	9,545	PZ2	500	250	1.500
•TEXZP40080	4 x 80	9,607	PZ2	500	250	1.500
•TEXZP45016	4,5 x 16	3,010	PZ2	2.000	1.000	12.000
•TEXZP45020	4,5 x 20	4,219	PZ2	2.000	1.000	12.000
•TEXZP45025	4,5 x 25	4,465	PZ2	2.000	1.000	12.000
•TEXZP45030	4,5 x 30	4,925	PZ2	1.000	500	6.000
•TEXZP45035	4,5 x 35	5,923	PZ2	1.000	500	6.000
•TEXZP45040	4,5 x 40	6,403	PZ2	1.000	500	3.000
•TEXZP45045	4,5 x 45	7,366	PZ2	500	250	3.000
•TEXZP45050	4,5 x 50	7,597	PZ2	500	250	3.000
•TEXZP45060	4,5 x 60	9,738	PZ2	500	250	1.500
•TEXZP45070	4,5 x 70	11,194	PZ2	500	250	1.500
•TEXZP45080	4,5 x 80	14,752	PZ2	200	100	1.200
•TEXZP50025	5 x 25	5,147	PZ2	2.000	1.000	6.000
•TEXZP50030	5 x 30	6,639	PZ2	1.000	500	6.000
•TEXZP50035	5 x 35	6,892	PZ2	1.000	500	6.000
•TEXZP50040	5 x 40	8,161	PZ2	1.000	500	6.000
•TEXZP50045	5 x 45	8,998	PZ2	500	250	3.000
•TEXZP50050	5 x 50	9,528	PZ2	500	250	3.000
•TEXZP50060	5 x 60	12,354	PZ2	500	250	1.500
•TEXZP50070	5 x 70	14,537	PZ2	400	200	1.200
•TEXZP50080	5 x 80	17,937	PZ2	200	100	1.200
•TEXZP50090	5 x 90	19,464	PZ2	200	100	1.200
•TEXZP50100	5 x 100	21,909	PZ2	200	100	1.200
•TEXZP50110	5 x 110	24,847	PZ2	200	100	1.200
•TEXZP50120	5 x 120	28,445	PZ2	200	100	1.200
•TEXZP60040	6 x 40	12,407	PZ3	500	250	3.000
•TEXZP60045	6 x 45	13,941	PZ3	500	250	3.000
•TEXZP60050	6 x 50	15,799	PZ3	500	250	1.500
•TEXZP60060	6 x 60	18,258	PZ3	500	250	1.500
•TEXZP60070	6 x 70	20,438	PZ3	200	100	600
•TEXZP60080	6 x 80	22,146	PZ3	200	100	1.200
•TEXZP60090	6 x 90	25,784	PZ3	200	100	1.200
•TEXZP60100	6 x 100	26,369	PZ3	200	100	600
•TEXZP60110	6 x 110	36,856	PZ3	200	100	600
•TEXZP60120	6 x 120	40,482	PZ3	200	100	600



Disponible en varios recubrimientos. Consulte precio y plazo de entrega.



• Medidas sin homologar
• Hasta fin de existencias

Blíster

CÓDIGO	MEDIDA	€/BOLSA	PCS	BOLSAS
BZTXZP30016	3 x 16	2,582	40	20
BZTXZP30020	3 x 20	2,582	40	20
BZTXZP30025	3 x 25	2,582	40	20
BZTXZP30030	3 x 30	2,582	40	20
BZTXZP35016	3,5 x 16	2,582	40	20
BZTXZP35020	3,5 x 20	2,582	40	20
BZTXZP35025	3,5 x 25	2,582	40	20
BZTXZP35030	3,5 x 30	2,582	40	20
BZTXZP35035	3,5 x 35	2,582	20	20
BZTXZP35040	3,5 x 40	2,582	20	20
BZTXZP35050	3,5 x 50	2,582	20	20
BZTXZP40025	4 x 25	2,582	40	20
BZTXZP40030	4 x 30	2,582	20	20
BZTXZP40035	4 x 35	2,582	20	20
BZTXZP40040	4 x 40	2,582	20	20
BZTXZP40045	4 x 45	2,582	20	20
BZTXZP40050	4 x 50	2,582	10	20
BZTXZP40060	4 x 60	2,582	10	20
BZTXZP45030	4,5 x 30	2,582	20	20
BZTXZP45035	4,5 x 35	2,582	20	20
BZTXZP45040	4,5 x 40	2,582	20	20
BZTXZP45045	4,5 x 45	2,582	10	20
BZTXZP45050	4,5 x 50	2,582	10	20
BZTXZP45060	4,5 x 60	2,582	10	20
BZTXZP45070	4,5 x 70	2,582	10	20
BZTXZP50030	5 x 30	2,582	10	20
BZTXZP50035	5 x 35	2,582	10	20
BZTXZP50040	5 x 40	2,582	10	20
BZTXZP50050	5 x 50	2,582	10	20
BZTXZP50060	5 x 60	2,582	10	20
BZTXZP50070	5 x 70	2,582	4	20
BZTXZP50080	5 x 80	2,582	4	20
BZTXZP60050	6 x 50	2,582	10	20
BZTXZP60060	6 x 60	2,582	10	20
BZTXZP60070	6 x 70	2,582	4	20
BZTXZP60080	6 x 80	2,582	4	20

Caja ventana

CÓDIGO	MEDIDA	€/CAJA	PCS	CAJAS
VTEXZP30016	3 x 16	4,880	200	8
VTEXZP30020	3 x 20	5,248	200	8
VTEXZP30025	3 x 25	5,300	200	8
VTEXZP30030	3 x 30	6,040	170	8
VTEXZP30040	3 x 40	5,825	120	8
VTEXZP35016	3,5 x 16	5,604	200	8
VTEXZP35020	3,5 x 20	6,285	200	8
VTEXZP35025	3,5 x 25	5,996	170	8
VTEXZP35030	3,5 x 30	6,122	150	8
VTEXZP35035	3,5 x 35	5,130	100	8
VTEXZP35040	3,5 x 40	3,970	75	8
VTEXZP35050	3,5 x 50	6,417	75	8
VTEXZP40025	4 x 25	5,577	125	8
VTEXZP40030	4 x 30	5,174	100	8
VTEXZP40035	4 x 35	4,048	75	8
VTEXZP40040	4 x 40	4,384	75	8
VTEXZP40045	4 x 45	5,646	75	8
VTEXZP40050	4 x 50	3,850	50	8
VTEXZP40060	4 x 60	5,392	50	8
VTEXZP45030	4,5 x 30	6,194	100	8
VTEXZP45035	4,5 x 35	5,463	75	8
VTEXZP45040	4,5 x 40	5,379	75	8
VTEXZP45045	4,5 x 45	4,844	50	8
VTEXZP45050	4,5 x 50	4,655	50	8
VTEXZP45060	4,5 x 60	6,475	50	8
VTEXZP45070	4,5 x 70	7,711	50	8
VTEXZP50030	5 x 30	5,903	75	8
VTEXZP50035	5 x 35	5,981	75	8
VTEXZP50040	5 x 40	5,035	50	8
VTEXZP50045	5 x 45	5,499	50	8
VTEXZP50050	5 x 50	5,609	50	8
VTEXZP50060	5 x 60	3,657	25	8
VTEXZP50070	5 x 70	4,671	25	8
VTEXZP50080	5 x 80	5,206	25	8
VTEXZP60050	6 x 50	7,766	40	8
VTEXZP60060	6 x 60	6,357	30	8
VTEXZP60070	6 x 70	5,110	20	8
VTEXZP60080	6 x 80	6,040	20	8

TEX-BT

Bicromatado. Huella TX



CÓDIGO	MEDIDA	€/100		UD. MIN. VENTA		
TEXBT10080	10 x 80	80,711	TX40	50	50	-
TEXBT10100	10 x 100	101,137	TX40	50	50	400
TEXBT10120	10 x 120	116,638	TX40	50	50	-
TEXBT10140	10 x 140	140,696	TX40	50	50	300
TEXBT10160	10 x 160	164,303	TX40	50	50	-
TEXBT10180	10 x 180	213,668	TX40	50	50	-
TEXBT10200	10 x 200	269,031	TX40	50	50	-
TEXBT10220	10 x 220	282,878	TX40	50	50	-
TEXBT10240	10 x 240	347,548	TX40	50	50	-
• TEXBT30016	3 x 16	2,239	TX10	2.000	1.000	24.000
• TEXBT30020	3 x 20	2,318	TX10	2.000	1.000	24.000
TEXBT30025	3 x 25	2,973	TX10	2.000	1.000	24.000
TEXBT30030	3 x 30	3,430	TX10	2.000	1.000	12.000
TEXBT30035	3 x 35	3,485	TX10	2.000	1.000	12.000
TEXBT30040	3 x 40	3,803	TX10	2.000	1.000	6.000
• TEXBT35012	3,5 x 12	2,451	TX15	2.000	1.000	24.000
• TEXBT35016	3,5 x 16	2,582	TX15	2.000	1.000	24.000
• TEXBT35020	3,5 x 20	2,697	TX15	2.000	1.000	24.000
TEXBT35025	3,5 x 25	3,367	TX15	2.000	1.000	12.000
TEXBT35030	3,5 x 30	3,941	TX15	2.000	1.000	12.000
TEXBT35035	3,5 x 35	4,172	TX15	2.000	1.000	12.000
TEXBT35040	3,5 x 40	5,054	TX15	1.000	500	6.000
TEXBT35045	3,5 x 45	5,647	TX15	1.000	500	6.000
TEXBT35050	3,5 x 50	6,377	TX15	1.000	500	6.000
• TEXBT40016	4 x 16	2,926	TX20	2.000	1.000	24.000
• TEXBT40020	4 x 20	3,329	TX20	2.000	1.000	12.000
• TEXBT40025	4 x 25	3,763	TX20	2.000	1.000	12.000
TEXBT40030	4 x 30	4,174	TX20	2.000	1.000	6.000
TEXBT40035	4 x 35	5,044	TX20	1.000	500	6.000
TEXBT40040	4 x 40	5,530	TX20	1.000	500	3.000
TEXBT40045	4 x 45	6,764	TX20	1.000	500	3.000
TEXBT40050	4 x 50	6,930	TX20	1.000	500	3.000
TEXBT40055	4 x 55	7,746	TX20	500	250	3.000
TEXBT40060	4 x 60	8,916	TX20	500	250	3.000
TEXBT40070	4 x 70	10,489	TX20	500	250	1.500
• TEXBT45025	4,5 x 25	4,906	TX20	2.000	1.000	12.000
• TEXBT45030	4,5 x 30	5,239	TX20	1.000	500	6.000
TEXBT45035	4,5 x 35	6,369	TX20	1.000	500	6.000
TEXBT45040	4,5 x 40	6,601	TX20	1.000	500	3.000
TEXBT45045	4,5 x 45	7,753	TX20	500	250	3.000
TEXBT45050	4,5 x 50	7,913	TX20	500	250	3.000
TEXBT45060	4,5 x 60	10,360	TX20	500	250	1.500
TEXBT45070	4,5 x 70	12,721	TX20	500	250	1.500
TEXBT45080	4,5 x 80	16,763	TX20	200	100	1.200
• TEXBT50030	5 x 30	7,296	TX25	1.000	500	6.000
TEXBT50035	5 x 35	7,831	TX25	1.000	500	6.000
TEXBT50040	5 x 40	8,502	TX25	1.000	500	6.000

CÓDIGO	MEDIDA	€/100		UD. MIN. VENTA		
TEXBT50045	5 x 45	9,888	TX25	500	250	3.000
TEXBT50050	5 x 50	10,672	TX25	500	250	3.000
TEXBT50060	5 x 60	13,284	TX25	500	250	2.000
TEXBT50070	5 x 70	15,631	TX25	400	200	1.200
TEXBT50080	5 x 80	19,931	TX25	200	100	1.200
TEXBT50090	5 x 90	20,066	TX25	200	100	1.200
TEXBT50100	5 x 100	22,587	TX25	200	100	1.200
TEXBT50120	5 x 120	29,630	TX25	200	100	1.200
• TEXBT60040	6 x 40	13,634	TX30	500	250	3.000
• TEXBT60045	6 x 45	15,320	TX30	500	250	3.000
• TEXBT60050	6 x 50	16,988	TX30	500	250	2.000
TEXBT60060	6 x 60	19,632	TX30	500	250	1.500
TEXBT60070	6 x 70	21,977	TX30	200	100	1.200
TEXBT60080	6 x 80	23,813	TX30	200	100	1.200
TEXBT60090	6 x 90	27,430	TX30	200	100	800
TEXBT60100	6 x 100	28,052	TX30	200	100	800
TEXBT60110	6 x 110	43,360	TX30	200	100	600
TEXBT60120	6 x 120	44,002	TX30	200	100	1.200
TEXBT60130	6 x 130	48,317	TX30	200	100	600
TEXBT60140	6 x 140	53,862	TX30	200	100	600
TEXBT60150	6 x 150	62,850	TX30	200	100	600
TEXBT60160	6 x 160	70,038	TX30	100	100	600
TEXBT60180	6 x 180	94,785	TX30	100	100	800
TEXBT60200	6 x 200	100,918	TX30	100	100	800
TEXBT60220	6 x 220	122,817	TX30	100	100	-
TEXBT60240	6 x 240	145,985	TX30	100	100	-
TEXBT60260	6 x 260	159,603	TX30	100	100	-
TEXBT60280	6 x 280	192,771	TX30	100	100	-
TEXBT60300	6 x 300	213,418	TX30	100	100	-
TEXBT80080	8 x 80	45,629	TX40	200	100	600
TEXBT80100	8 x 100	60,433	TX40	100	50	300
TEXBT80120	8 x 120	79,101	TX40	100	50	400
TEXBT80140	8 x 140	88,259	TX40	50	50	400
TEXBT80160	8 x 160	109,877	TX40	50	50	400
TEXBT80180	8 x 180	134,507	TX40	50	50	200
TEXBT80200	8 x 200	154,548	TX40	50	50	400
TEXBT80220	8 x 220	180,430	TX40	50	50	400
TEXBT80240	8 x 240	201,505	TX40	50	50	400
TEXBT80260	8 x 260	258,921	TX40	50	50	-
TEXBT80280	8 x 280	261,425	TX40	50	50	-
TEXBT80300	8 x 300	281,129	TX40	50	50	200
TEXBT80320	8 x 320	299,895	TX40	50	50	-
TEXBT80340	8 x 340	319,559	TX40	50	50	-
TEXBT80360	8 x 360	386,685	TX40	50	50	-
TEXBT80380	8 x 380	407,121	TX40	50	50	-
TEXBT80400	8 x 400	468,323	TX40	50	50	-

• Medidas sin homologar
• Hasta fin de existencias



Tirafondo de alto rendimiento

TEX

MADERA



CÓDIGO	MEDIDA	€/100		UD. MIN. VENTA		
• TEXZT30016	3 x 16	2,239	TX10	2.000	1.000	24.000
• TEXZT30020	3 x 20	2,318	TX10	2.000	1.000	24.000
TEXZT30025	3 x 25	2,973	TX10	2.000	1.000	24.000
TEXZT30030	3 x 30	3,430	TX10	2.000	1.000	12.000
TEXZT30035	3 x 35	3,485	TX10	2.000	1.000	12.000
TEXZT30040	3 x 40	3,803	TX10	2.000	1.000	6.000
• TEXZT35012	3,5 x 12	2,451	TX15	2.000	1.000	24.000
• TEXZT35016	3,5 x 16	2,582	TX15	2.000	1.000	24.000
• TEXZT35020	3,5 x 20	2,697	TX15	2.000	1.000	24.000
TEXZT35025	3,5 x 25	3,367	TX15	2.000	1.000	12.000
TEXZT35030	3,5 x 30	3,941	TX15	2.000	1.000	12.000
TEXZT35035	3,5 x 35	4,172	TX15	2.000	1.000	12.000
TEXZT35040	3,5 x 40	5,054	TX15	1.000	500	6.000
TEXZT35045	3,5 x 45	5,647	TX15	1.000	500	6.000
TEXZT35050	3,5 x 50	6,377	TX15	1.000	500	6.000
• TEXZT40016	4 x 16	2,926	TX20	2.000	1.000	24.000
• TEXZT40020	4 x 20	3,329	TX20	2.000	1.000	12.000
• TEXZT40025	4 x 25	3,763	TX20	2.000	1.000	12.000
TEXZT40030	4 x 30	4,174	TX20	2.000	1.000	6.000
TEXZT40035	4 x 35	5,044	TX20	1.000	500	6.000
TEXZT40040	4 x 40	5,530	TX20	1.000	500	6.000
TEXZT40045	4 x 45	6,764	TX20	1.000	500	6.000
TEXZT40050	4 x 50	6,930	TX20	1.000	500	6.000
TEXZT40055	4 x 55	7,746	TX20	500	250	3.000
TEXZT40060	4 x 60	8,916	TX20	500	250	3.000
TEXZT40070	4 x 70	10,489	TX20	500	250	1.500
• TEXZT45030	4,5 x 30	5,239	TX20	1.000	500	6.000
TEXZT45035	4,5 x 35	6,369	TX20	1.000	500	6.000
TEXZT45040	4,5 x 40	6,601	TX20	1.000	500	3.000
TEXZT45050	4,5 x 50	7,913	TX20	500	250	3.000
TEXZT45060	4,5 x 60	10,360	TX20	500	250	1.500
TEXZT45070	4,5 x 70	12,721	TX20	500	250	1.500

CÓDIGO	MEDIDA	€/100		UD. MIN. VENTA		
TEXZT45080	4,5 x 80	16,763	TX20	200	100	1.200
• TEXZT50030	5 x 30	7,296	TX25	1.000	500	6.000
TEXZT50035	5 x 35	7,831	TX25	1.000	500	6.000
TEXZT50040	5 x 40	8,502	TX25	1.000	500	6.000
TEXZT50045	5 x 45	9,888	TX25	500	250	3.000
TEXZT50050	5 x 50	10,672	TX25	500	250	3.000
TEXZT50060	5 x 60	13,284	TX25	500	250	2.000
TEXZT50070	5 x 70	15,631	TX25	400	200	1.200
TEXZT50080	5 x 80	19,931	TX25	200	100	1.200
TEXZT50090	5 x 90	20,066	TX25	200	100	1.200
TEXZT50100	5 x 100	22,587	TX25	200	100	1.200
• TEXZT60050	6 x 50	16,988	TX30	500	250	2.000
TEXZT60060	6 x 60	19,632	TX30	500	250	1.500
TEXZT60070	6 x 70	21,977	TX30	200	100	1.200
TEXZT60080	6 x 80	23,813	TX30	200	100	1.200
TEXZT60090	6 x 90	27,430	TX30	200	100	800
TEXZT60100	6 x 100	28,052	TX30	200	100	800
TEXZT60110	6 x 110	43,360	TX30	200	100	600
TEXZT60120	6 x 120	44,002	TX30	200	100	600
TEXZT60130	6 x 130	48,317	TX30	100	100	600
TEXZT60140	6 x 140	53,862	TX30	100	100	600
TEXZT60150	6 x 150	62,850	TX30	100	100	600
TEXZT60160	6 x 160	70,038	TX30	100	100	600
TEXZT60180	6 x 180	94,785	TX30	100	100	800
TEXZT60200	6 x 200	100,918	TX30	100	100	300
TEXZT60220	6 x 220	122,817	TX30	100	100	-
TEXZT60240	6 x 240	145,985	TX30	100	100	600
TEXZT60260	6 x 260	159,603	TX30	100	100	-
TEXZT60280	6 x 280	192,771	TX30	100	100	-
TEXZT60300	6 x 300	213,418	TX30	100	100	-

• Medidas sin homologar
• Hasta fin de existencias

TEX-ZT

Zincado. Huella TX



Disponible en varios recubrimientos. Consulte precio y plazo de entrega.



INOXIDABLE



CÓDIGO	MEDIDA	€/100			
TEXA250050	5 x 50	27,858	TX25	250	3.000
TEXA250060	5 x 60	33,477	TX25	100	2.400
TEXA250070	5 x 70	40,050	TX25	100	2.400

Caja ventana

CÓDIGO	MEDIDA	€/CAJA	PCS	CAJAS
VTEXA250050	5 x 50	7,569	20	8
VTEXA250060	5 x 60	9,092	20	8
VTEXA250070	5 x 70	10,310	20	8

TEX-A2

Inoxidable A2. Huella TX



INDEX
A PERFECT FIXING

Expositor

Tornillería para madera



BLISTER



CAJA CON VENTANA



CAJA PROFESIONAL



DIMENSIONES
Ancho: 100 cm
Alto: 240 cm



Tirafondo de alto rendimiento

TEX

MADERA



CÓDIGO	MEDIDA	€/100			
TECBT60080	6 x 80	34,639	TX30	200	1.200
TECBT60100	6 x 100	38,561	TX30	100	1.200
TECBT60120	6 x 120	57,336	TX30	100	600
TECBT60140	6 x 140	68,473	TX30	100	600
TECBT60160	6 x 160	93,825	TX30	100	400
TECBT60180	6 x 180	118,389	TX30	100	-
TECBT60200	6 x 200	152,589	TX30	100	-
TECBT80080	8 x 80	65,534	TX40	50	600
TECBT80100	8 x 100	75,019	TX40	50	300
TECBT80120	8 x 120	101,552	TX40	50	300
TECBT80140	8 x 140	108,633	TX40	50	300
TECBT80160	8 x 160	154,182	TX40	50	200
TECBT80180	8 x 180	160,512	TX40	50	-
TECBT80200	8 x 200	187,523	TX40	50	-
TECBT80220	8 x 220	212,474	TX40	50	-
TECBT80240	8 x 240	241,946	TX40	50	-
TECBT80260	8 x 260	283,357	TX40	50	-

CÓDIGO	MEDIDA	€/100			
TECBT80280	8 x 280	285,611	TX40	50	-
TECBT80300	8 x 300	325,191	TX40	50	-
TECBT10100	10 x 100	119,703	TX40	50	300
TECBT10120	10 x 120	150,053	TX40	50	300
TECBT10140	10 x 140	180,997	TX40	50	300
TECBT10160	10 x 160	211,369	TX40	50	200
TECBT10180	10 x 180	284,145	TX40	50	-
TECBT10200	10 x 200	319,219	TX40	25	-
TECBT10220	10 x 220	359,847	TX40	25	-
TECBT10240	10 x 240	396,973	TX40	25	-
TECBT10260	10 x 260	431,823	TX40	25	-
TECBT10280	10 x 280	484,487	TX40	25	-
TECBT10300	10 x 300	530,528	TX40	25	-



TEC-BT

Cabeza ancha bicromatado. Huella TX



MADERA



CÓDIGO	MEDIDA	€/100		
TEXABM06	Ø6	70,142	100	2.400
TEXABM08	Ø8	75,952	100	2.400
TEXABM10	Ø10	128,857	100	1.200

TEX-AB

Arandela cónica



INDEXwood VI

SOFTWARE DE DISEÑO PARA EL CÁLCULO DE ESTRUCTURAS DE MADERA

Permite realizar cálculos de fijaciones estructurales en madera con tirafondos, de acuerdo con el Eurocódigo 5 (norma EN 1995-1-1).



TEX

TIRAFONDO DE ALTAS PRESTACIONES PARA MADERA



CARACTERÍSTICAS TORNILLOS TEX • TABLA COMPARATIVA

TECBT	TEXBT	TEXBP	TEXZT	TEXZP	Ø	LONGITUD TORNILLO	LONGITUD ROSCA	LIMPIADOR	HUELLA
-	-	TEXBP25010	-	TEXZP25010	2,5	10	COMPLETA	NO	TX10 / PZ1
-	-	TEXBP25012	-	TEXZP25012		12			
-	-	TEXBP25016	-	TEXZP25016		16			
-	-	TEXBP25020	-	TEXZP25020		20			
-	-	TEXBP25025	-	TEXZP25025		25			
-	-	TEXBP30010	-	TEXZP30010	3	10	COMPLETA	NO	TX10 / PZ1
-	-	TEXBP30012	-	TEXZP30012		12			
-	-	TEXBP30015	-	TEXZP30015		15			
-	TEXBT30016	TEXBP30016	TEXZT30016	TEXZP30016		16			
-	TEXBT30020	TEXBP30020	TEXZT30020	TEXZP30020		20			
-	TEXBT30025	TEXBP30025	TEXZT30025	TEXZP30025		25			
-	TEXBT30030	TEXBP30030	TEXZT30030	TEXZP30030		30			
-	TEXBT30035	TEXBP30035	TEXZT30035	TEXZP30035		35			
-	TEXBT30040	TEXBP30040	TEXZT30040	TEXZP30040		40			
-	-	TEXBP30045	-	TEXZP30045		45			
-	-	TEXBP35010	-	TEXZP35010	3,5	10	COMPLETA	NO	TX15 / PZ2
-	TEXBT35012	TEXBP35012	TEXZT35012	TEXZP35012		12			
-	-	TEXBP35015	-	TEXZP35015		15			
-	TEXBT35016	TEXBP35016	TEXZT35016	TEXZP35016		16			
-	TEXBT35020	TEXBP35020	TEXZT35020	TEXZP35020		20			
-	TEXBT35025	TEXBP35025	TEXZT35025	TEXZP35025		25			
-	TEXBT35030	TEXBP35030	TEXZT35030	TEXZP35030		30			
-	TEXBT35035	TEXBP35035	TEXZT35035	TEXZP35035		35			
-	TEXBT35040	TEXBP35040	TEXZT35040	TEXZP35040		40			
-	TEXBT35045	TEXBP35045	TEXZT35045	TEXZP35045		45			
-	TEXBT35050	TEXBP35050	TEXZT35050	TEXZP35050	50				
-	-	TEXBP40012	-	TEXZP40012	4	12	COMPLETA	NO	TX20 / PZ2
-	-	TEXBP40015	-	TEXZP40015		15			
-	TEXBT40016	TEXBP40016	TEXZT40016	TEXZP40016		16			
-	TEXBT40020	TEXBP40020	TEXZT40020	TEXZP40020		20			
-	TEXBT40025	TEXBP40025	TEXZT40025	TEXZP40025		25			
-	TEXBT40030	TEXBP40030	TEXZT40030	TEXZP40030		30			
-	TEXBT40035	TEXBP40035	TEXZT40035	TEXZP40035		35			
-	TEXBT40040	TEXBP40040	TEXZT40040	TEXZP40040		40			
-	TEXBT40045	TEXBP40045	TEXZT40045	TEXZP40045		45			
-	TEXBT40050	TEXBP40050	TEXZT40050	TEXZP40050		50			
-	TEXBT40055	TEXBP40055	TEXZT40055	TEXZP40055	55				
-	TEXBT40060	TEXBP40060	TEXZT40060	TEXZP40060	60				
-	TEXBT40070	TEXBP40070	TEXZT40070	TEXZP40070	70				
-	-	TEXBP40080	-	TEXZP40080	80				
-	-	TEXBP45016	-	TEXZP45016	4,5	16	COMPLETA	NO	TX20 / PZ2
-	-	TEXBP45020	-	TEXZP45020		20			
-	TEXBT45025	TEXBP45025	-	TEXZP45025		25			
-	TEXBT45030	TEXBP45030	TEXZT45030	TEXZP45030		30			
-	TEXBT45035	TEXBP45035	TEXZT45035	TEXZP45035		35			
-	TEXBT45040	TEXBP45040	TEXZT45040	TEXZP45040		40			
-	TEXBT45045	TEXBP45045	-	TEXZP45045		45			
-	TEXBT45050	TEXBP45050	TEXZT45050	TEXZP45050		50			
-	TEXBT45060	TEXBP45060	TEXZT45060	TEXZP45060		60			
-	TEXBT45070	TEXBP45070	TEXZT45070	TEXZP45070		70			
-	TEXBT45080	TEXBP45080	TEXZT45080	TEXZP45080	80				

TECBT	TEXBT	TEXBP	TEXZT	TEXZP	Ø	LONGITUD TORNILLO	LONGITUD ROSCA	LIMPIADOR	HUELLA	
-	-	TEXBP50025	-	TEXZP50025	5	25	COMPLETA	NO	TX25 / PZ2	
-	TEXBT50030	TEXBP50030	TEXZT50030	TEXZP50030		30				
-	TEXBT50035	TEXBP50035	TEXZT50035	TEXZP50035		35				
-	TEXBT50040	TEXBP50040	TEXZT50040	TEXZP50040		40	30			
-	TEXBT50045	TEXBP50045	TEXZT50045	TEXZP50045		45				
-	TEXBT50050	TEXBP50050	TEXZT50050	TEXZP50050		50				
-	TEXBT50060	TEXBP50060	TEXZT50060	TEXZP50060		60	50			
-	TEXBT50070	TEXBP50070	TEXZT50070	TEXZP50070		70				
-	TEXBT50080	TEXBP50080	TEXZT50080	TEXZP50080		80				
-	TEXBT50090	TEXBP50090	TEXZT50090	TEXZP50090		90	60			SI
-	TEXBT50100	TEXBP50100	TEXZT50100	TEXZP50100		100				
-	-	TEXBP50110	-	TEXZP50110		110				
-	TEXBT50120	TEXBP50120	-	TEXZP50120	120	70				
-	TEXBT60040	TEXBP60040	-	TEXZP60040	40					
-	TEXBT60045	TEXBP60045	-	TEXZP60045	45					
-	TEXBT60050	TEXBP60050	TEXZT60050	TEXZP60050	50	30	NO			
-	TEXBT60060	TEXBP60060	TEXZT60060	TEXZP60060	60					
-	TEXBT60070	TEXBP60070	TEXZT60070	TEXZP60070	70					
TECBT60080	TEXBT60080	TEXBP60080	TEXZT60080	TEXZP60080	80	50				
-	TEXBT60090	TEXBP60090	TEXZT60090	TEXZP60090	90					
TECBT60100	TEXBT60100	TEXBP60100	TEXZT60100	TEXZP60100	100					
-	TEXBT60110	TEXBP60110	TEXZT60110	TEXZP60110	110	60				
TECBT60120	TEXBT60120	TEXBP60120	TEXZT60120	TEXZP60120	120					
-	TEXBT60130	-	TEXZT60130	-	130					
TECBT60140	TEXBT60140	-	TEXZT60140	-	140	70		SI	TX30 / PZ3	
-	TEXBT60150	-	TEXZT60150	-	150					
TECBT60160	TEXBT60160	-	TEXZT60160	-	160					
TECBT60180	TEXBT60180	-	TEXZT60180	-	180					
TECBT60200	TEXBT60200	-	TEXZT60200	-	200					
-	TEXBT60220	-	TEXZT60220	-	220					
-	TEXBT60240	-	TEXZT60240	-	240					
-	TEXBT60260	-	TEXZT60260	-	260					
-	TEXBT60280	-	TEXZT60280	-	280					
-	TEXBT60300	-	TEXZT60300	-	300					
TECBT80080	TEXBT80080	-	-	-	80		50			NO
TECBT80100	TEXBT80100	-	-	-	100					
TECBT80120	TEXBT80120	-	-	-	120					
TECBT80140	TEXBT80140	-	-	-	140	80				
TECBT80160	TEXBT80160	-	-	-	160					
TECBT80180	TEXBT80180	-	-	-	180					
TECBT80200	TEXBT80200	-	-	-	200	100				
TECBT80220	TEXBT80220	-	-	-	220					
TECBT80240	TEXBT80240	-	-	-	240					
TECBT80260	TEXBT80260	-	-	-	260					
TECBT80280	TEXBT80280	-	-	-	280					
TECBT80300	TEXBT80300	-	-	-	300					
-	TEXBT80320	-	-	-	320					
-	TEXBT80340	-	-	-	340					
-	TEXBT80360	-	-	-	360					
-	TEXBT80380	-	-	-	380					
-	TEXBT80400	-	-	-	400					
-	TEXBT10080	-	-	-	80		50	NO		
TECBT10100	TEXBT10100	-	-	-	100					
TECBT10120	TEXBT10120	-	-	-	120					
TECBT10140	TEXBT10140	-	-	-	140	80				
TECBT10160	TEXBT10160	-	-	-	160					
TECBT10180	TEXBT10180	-	-	-	180					
TECBT10200	TEXBT10200	-	-	-	200	100	SI			
TECBT10220	TEXBT10220	-	-	-	220					
TECBT10240	TEXBT10240	-	-	-	240					
TECBT10260	-	-	-	-	80				40	
TECBT10280	-	-	-	-	100					
TECBT10300	-	-	-	-	120					

TP-PO B

Bicromatado. Huella PZ



CÓDIGO	MEDIDA	€/100		LONGITUD DE LA ROSCA	UD. MIN. VENTA		
• TPPO25010	2,5 x 10	1,107		Total	2.000	1.000	45.000
• TPPO25012	2,5 x 12	1,117	PZ1	Total	2.000	1.000	45.000
• TPPO25016	2,5 x 16	1,247	PZ1	Total	2.000	1.000	45.000
TPPO25020	2,5 x 20	1,397	PZ1	Total	2.000	1.000	24.000
TPPO25025	2,5 x 25	1,523	PZ1	Total	2.000	1.000	24.000
• TPPO30012	3 x 12	0,990	PZ1	Total	2.000	1.000	45.000
• TPPO30016	3 x 16	1,083	PZ1	Total	2.000	1.000	24.000
• TPPO30020	3 x 20	1,230	PZ1	Total	2.000	1.000	24.000
TPPO30025	3 x 25	1,414	PZ1	Total	2.000	1.000	12.000
TPPO30030	3 x 30	1,574	PZ1	Total	2.000	1.000	12.000
TPPO30040	3 x 40	2,157	PZ1	Total	2.000	1.000	6.000
• TPPO35016	3,5 x 16	1,217	PZ2	Total	2.000	1.000	24.000
• TPPO35020	3,5 x 20	1,478	PZ2	Total	2.000	1.000	12.000
TPPO35025	3,5 x 25	1,629	PZ2	Total	2.000	1.000	12.000
TPPO35030	3,5 x 30	1,875	PZ2	Total	2.000	1.000	12.000
TPPO35035	3,5 x 35	2,241	PZ2	Total	1.000	500	6.000
TPPO35040	3,5 x 40	2,414	PZ2	Total	1.000	500	6.000
TPPO35050	3,5 x 50	3,155	PZ2	Total	500	250	3.000
• TPPO40016	4 x 16	1,537	PZ2	Total	2.000	1.000	16.000
• TPPO40020	4 x 20	1,828	PZ2	Total	2.000	1.000	12.000
• TPPO40025	4 x 25	2,037	PZ2	Total	2.000	1.000	12.000
TPPO40030	4 x 30	2,382	PZ2	Total	1.000	500	6.000
TPPO40035	4 x 35	2,700	PZ2	Total	1.000	500	6.000
TPPO40040	4 x 40	2,825	PZ2	Total	1.000	500	6.000
TPPO40045	4 x 45	3,447	PZ2	Total	1.000	500	3.000
TPPO40050	4 x 50	3,807	PZ2	Total	500	250	3.000
TPPO40060	4 x 60	4,367	PZ2	Total	500	250	3.000
TPPO40070	4 x 70	5,540	PZ2	Parcial 52	500	250	3.000
• TPPO45020	4,5 x 20	2,237	PZ2	Total	1.000	500	12.000
• TPPO45025	4,5 x 25	2,683	PZ2	Total	1.000	500	6.000
• TPPO45030	4,5 x 30	2,986	PZ2	Total	1.000	500	6.000
TPPO45035	4,5 x 35	3,380	PZ2	Total	1.000	500	6.000
TPPO45040	4,5 x 40	3,773	PZ2	Total	1.000	500	3.000
TPPO45045	4,5 x 45	4,323	PZ2	Total	500	250	3.000
TPPO45050	4,5 x 50	4,647	PZ2	Total	500	250	3.000
TPPO45060	4,5 x 60	5,657	PZ2	Total	500	250	3.000
TPPO45070	4,5 x 70	6,864	PZ2	Parcial 52	500	250	1.500
TPPO45080	4,5 x 80	8,221	PZ2	Parcial 52	200	100	1.200
• TPPO50020	5 x 20	2,811	PZ2	Total	1.000	500	6.000
• TPPO50025	5 x 25	3,383	PZ2	Total	1.000	500	6.000
• TPPO50030	5 x 30	3,713	PZ2	Total	500	250	6.000
TPPO50035	5 x 35	4,423	PZ2	Total	500	250	3.000
TPPO50040	5 x 40	4,756	PZ2	Total	500	250	3.000
TPPO50045	5 x 45	5,290	PZ2	Total	500	250	3.000
TPPO50050	5 x 50	5,557	PZ2	Total	500	250	3.000
TPPO50060	5 x 60	6,820	PZ2	Total	500	250	1.500
TPPO50070	5 x 70	8,317	PZ2	Parcial 52	200	100	1.200
TPPO50080	5 x 80	9,431	PZ2	Parcial 52	200	100	1.200
TPPO50090	5 x 90	11,557	PZ2	Parcial 60	200	100	1.200
TPPO50100	5 x 100	12,723	PZ2	Parcial 60	200	100	1.200
TPPO50120	5 x 120	18,559	PZ2	Parcial 75	200	100	1.200
• TPPO60040	6 x 40	7,100	PZ3	Total	500	250	3.000
TPPO60050	6 x 50	8,387	PZ3	Total	500	250	1.500
TPPO60060	6 x 60	9,760	PZ3	Total	500	250	1.500
TPPO60070	6 x 70	12,247	PZ3	Parcial 52	200	100	1.200
TPPO60080	6 x 80	13,731	PZ3	Parcial 52	200	100	1.200
TPPO60090	6 x 90	15,400	PZ3	Parcial 60	200	100	1.200
TPPO60100	6 x 100	16,706	PZ3	Parcial 60	100	100	1.200
TPPO60110	6 x 110	20,186	PZ3	Parcial 70	100	100	600
TPPO60120	6 x 120	21,692	PZ3	Parcial 70/75	100	100	600
TPPO60130	6 x 130	26,894	PZ3	Parcial 70/75	100	100	600
TPPO60140	6 x 140	28,333	PZ3	Parcial 70/75	100	100	600
TPPO60150	6 x 150	31,648	PZ3	Parcial 70/75	100	100	600
TPPO60160	6 x 160	33,760	PZ3	Parcial 70/75	100	100	400
TPPO60180	6 x 180	47,643	PZ3	Parcial 70/75	100	100	300
TPPO60200	6 x 200	62,026	PZ3	Parcial 70/75	100	100	300
TPPO60220	6 x 220	96,568	PZ3	Parcial 70/75	100	100	300

• Medidas sin homologar



Tirafondos de cabeza avellanada

TP

TP-PO B

Bicromatado. Huella PZ



Blíster

CÓDIGO	MEDIDA	€/BOLSA	PCS	BOLSAS
BZTPP025016	2,5 x 16	2,040	40	20
BZTPP025020	2,5 x 20	2,040	40	20
BZTPP025025	2,5 x 25	2,040	40	20
BZTPP030016	3 x 16	2,040	40	20
BZTPP030020	3 x 20	2,040	40	20
BZTPP030025	3 x 25	2,040	40	20
BZTPP030030	3 x 30	2,040	40	20
BZTPP035016	3,5 x 16	2,040	40	20
BZTPP035020	3,5 x 20	2,040	40	20
BZTPP035025	3,5 x 25	2,040	40	20
BZTPP035030	3,5 x 30	2,040	40	20
BZTPP035035	3,5 x 35	2,040	20	20
BZTPP035040	3,5 x 40	2,040	20	20
BZTPP035050	3,5 x 50	2,040	20	20
BZTPP040016	4 x 16	2,040	40	20
BZTPP040020	4 x 20	2,040	40	20
BZTPP040025	4 x 25	2,040	40	20
BZTPP040030	4 x 30	2,040	20	20
BZTPP040035	4 x 35	2,040	20	20
BZTPP040040	4 x 40	2,040	20	20
BZTPP040045	4 x 45	2,040	20	20
BZTPP040050	4 x 50	2,040	10	20
BZTPP040060	4 x 60	2,040	10	20
BZTPP045030	4,5 x 30	2,040	20	20
BZTPP045035	4,5 x 35	2,040	20	20
BZTPP045040	4,5 x 40	2,040	20	20
BZTPP045045	4,5 x 45	2,040	10	20
BZTPP045050	4,5 x 50	2,040	10	20
BZTPP045060	4,5 x 60	2,040	10	20
BZTPP045070	4,5 x 70	2,040	10	20
BZTPP050030	5 x 30	2,040	10	20
BZTPP050035	5 x 35	2,040	10	20
BZTPP050040	5 x 40	2,040	10	20
BZTPP050050	5 x 50	2,040	10	20
BZTPP050060	5 x 60	2,040	10	20
BZTPP050070	5 x 70	2,040	4	20
BZTPP050080	5 x 80	2,040	4	20
BZTPP050100	5 x 100	2,040	4	20
BZTPP060040	6 x 40	2,040	10	20
BZTPP060050	6 x 50	2,040	10	20
BZTPP060060	6 x 60	2,040	10	20
BZTPP060070	6 x 70	2,040	4	20
BZTPP060080	6 x 80	2,040	4	20
BZTPP060090	6 x 90	2,040	4	20
BZTPP060100	6 x 100	2,040	4	20



Caja ventana

CÓDIGO	MEDIDA	€/CAJA	PCS	CAJAS
VTPPO30016	3 x 16	3,858	250	8
VTPPO30020	3 x 20	4,308	250	8
VTPPO30025	3 x 25	4,904	250	8
VTPPO30030	3 x 30	5,363	250	8
VTPPO30040	3 x 40	6,582	250	8
VTPPO35016	3,5 x 16	4,426	250	8
VTPPO35020	3,5 x 20	4,818	250	8
VTPPO35025	3,5 x 25	5,493	250	8
VTPPO35030	3,5 x 30	5,889	250	8
VTPPO35035	3,5 x 35	4,667	150	8
VTPPO35040	3,5 x 40	4,848	150	8
VTPPO35050	3,5 x 50	4,379	100	8
VTPPO40016	4 x 16	5,221	250	8
VTPPO40020	4 x 20	5,977	250	8
VTPPO40025	4 x 25	6,606	250	8
VTPPO40030	4 x 30	5,404	175	8
VTPPO40035	4 x 35	5,226	150	8
VTPPO40040	4 x 40	5,625	150	8
VTPPO40045	4 x 45	6,868	150	8
VTPPO40050	4 x 50	5,168	100	8
VTPPO40060	4 x 60	6,029	100	8
VTPPO45030	4,5 x 30	6,047	150	8
VTPPO45035	4,5 x 35	6,626	150	8
VTPPO45040	4,5 x 40	7,126	150	8
VTPPO45045	4,5 x 45	5,387	90	8
VTPPO45050	4,5 x 50	6,428	100	8
VTPPO45060	4,5 x 60	6,012	80	8
VTPPO45070	4,5 x 70	5,445	60	8
VTPPO50030	5 x 30	5,066	100	8
VTPPO50035	5 x 35	5,514	100	8
VTPPO50040	5 x 40	6,047	100	8
VTPPO50050	5 x 50	7,243	100	8
VTPPO50060	5 x 60	7,182	80	8
VTPPO50070	5 x 70	4,255	35	8
VTPPO50080	5 x 80	3,981	30	8
VTPPO50090	5 x 90	4,454	30	8
VTPPO60040	6 x 40	8,975	100	8
VTPPO60050	6 x 50	8,034	80	8
VTPPO60060	6 x 60	7,156	60	8
VTPPO60070	6 x 70	4,642	30	8
VTPPO60080	6 x 80	5,154	30	8



TP-PO Z

Zincado. Huella PZ



Disponible en varios recubrimientos. Consulte precio y plazo de entrega.



CÓDIGO	MEDIDA	€/100		LONGITUD DE LA ROSCA	UD. MIN. VENTA		
• TPPOZ25010	2,5 x 10	1,107	PZ1	Total	2,000	1,000	45,000
• TPPOZ25012	2,5 x 12	1,117	PZ1	Total	2,000	1,000	45,000
• TPPOZ25016	2,5 x 16	1,247	PZ1	Total	2,000	1,000	45,000
TPPOZ25020	2,5 x 20	1,397	PZ1	Total	2,000	1,000	24,000
TPPOZ25025	2,5 x 25	1,523	PZ1	Total	2,000	1,000	24,000
• TPPOZ30012	3 x 12	0,990	PZ1	Total	2,000	1,000	45,000
• TPPOZ30016	3 x 16	1,083	PZ1	Total	2,000	1,000	24,000
• TPPOZ30020	3 x 20	1,230	PZ1	Total	2,000	1,000	24,000
TPPOZ30025	3 x 25	1,414	PZ1	Total	2,000	1,000	12,000
TPPOZ30030	3 x 30	1,574	PZ1	Total	2,000	1,000	12,000
TPPOZ30040	3 x 40	2,157	PZ1	Total	2,000	1,000	6,000
• TPPOZ35016	3,5 x 16	1,217	PZ2	Total	2,000	1,000	24,000
• TPPOZ35020	3,5 x 20	1,478	PZ2	Total	2,000	1,000	12,000
TPPOZ35025	3,5 x 25	1,629	PZ2	Total	2,000	1,000	12,000
TPPOZ35030	3,5 x 30	1,875	PZ2	Total	2,000	1,000	12,000
TPPOZ35035	3,5 x 35	2,241	PZ2	Total	1,000	500	6,000
TPPOZ35040	3,5 x 40	2,414	PZ2	Total	1,000	500	6,000
TPPOZ35050	3,5 x 50	3,155	PZ2	Total	500	250	3,000
• TPPOZ40016	4 x 16	1,537	PZ2	Total	2,000	1,000	16,000
• TPPOZ40020	4 x 20	1,828	PZ2	Total	2,000	1,000	12,000
• TPPOZ40025	4 x 25	2,037	PZ2	Total	2,000	1,000	12,000
TPPOZ40030	4 x 30	2,382	PZ2	Total	1,000	500	6,000
TPPOZ40035	4 x 35	2,700	PZ2	Total	1,000	500	6,000
TPPOZ40040	4 x 40	2,825	PZ2	Total	1,000	500	6,000
TPPOZ40045	4 x 45	3,447	PZ2	Total	1,000	500	3,000
TPPOZ40050	4 x 50	3,807	PZ2	Total	500	250	3,000
TPPOZ40060	4 x 60	4,367	PZ2	Total	500	250	3,000
TPPOZ40070	4 x 70	5,540	PZ2	Parcial 52	500	250	1,500
• TPPOZ45020	4,5 x 20	2,237	PZ2	Total	1,000	500	12,000
• TPPOZ45025	4,5 x 25	2,683	PZ2	Total	1,000	500	6,000
• TPPOZ45030	4,5 x 30	2,986	PZ2	Total	1,000	500	6,000
TPPOZ45035	4,5 x 35	3,380	PZ2	Total	1,000	500	6,000
TPPOZ45040	4,5 x 40	3,773	PZ2	Total	1,000	500	3,000
TPPOZ45045	4,5 x 45	4,323	PZ2	Total	500	250	3,000
TPPOZ45050	4,5 x 50	4,647	PZ2	Total	500	250	3,000
TPPOZ45060	4,5 x 60	5,657	PZ2	Total	500	250	3,000
TPPOZ45070	4,5 x 70	6,864	PZ2	Parcial 52	500	250	1,500
TPPOZ45080	4,5 x 80	8,221	PZ2	Parcial 52	200	100	1,200
• TPPOZ50020	5 x 20	2,811	PZ2	Total	1,000	500	6,000
• TPPOZ50025	5 x 25	3,383	PZ2	Total	1,000	500	6,000
• TPPOZ50030	5 x 30	3,713	PZ2	Total	500	250	6,000
TPPOZ50035	5 x 35	4,423	PZ2	Total	500	250	3,000
TPPOZ50040	5 x 40	4,756	PZ2	Total	500	250	3,000
TPPOZ50045	5 x 45	5,290	PZ2	Total	500	250	3,000
TPPOZ50050	5 x 50	5,557	PZ2	Total	500	250	3,000
TPPOZ50060	5 x 60	6,820	PZ2	Total	500	250	1,500
TPPOZ50070	5 x 70	8,317	PZ2	Parcial 52	200	100	1,200
TPPOZ50080	5 x 80	9,431	PZ2	Parcial 52	200	100	1,200
TPPOZ50090	5 x 90	11,557	PZ2	Parcial 60	200	100	1,200
TPPOZ50100	5 x 100	12,723	PZ2	Parcial 60	200	100	1,200
TPPOZ50120	5 x 120	18,559	PZ2	Parcial 75	200	100	1,200
• TPPOZ60040	6 x 40	7,100	PZ3	Total	500	250	3,000
TPPOZ60050	6 x 50	8,387	PZ3	Total	500	250	1,500
TPPOZ60060	6 x 60	9,760	PZ3	Total	500	250	1,500
TPPOZ60070	6 x 70	12,247	PZ3	Parcial 52	200	100	1,200
TPPOZ60080	6 x 80	13,731	PZ3	Parcial 52	200	100	1,200
TPPOZ60090	6 x 90	15,400	PZ3	Parcial 60	200	100	1,200
TPPOZ60100	6 x 100	16,706	PZ3	Parcial 60	100	100	1,200
TPPOZ60110	6 x 110	20,186	PZ3	Parcial 70	100	100	600

• Medidas sin homologar

TP-PO Z

Zincado. Huella PZ



Caja ventana

CÓDIGO	MEDIDA	€/CAJA	PCS	CAJAS
VTPOZ30025	3 x 25	4,904	250	8
VTPOZ30030	3 x 30	5,363	250	8
VTPOZ35016	2,5 x 16	4,426	250	8
VTPOZ35020	2,5 x 20	4,818	250	8
VTPOZ35025	2,5 x 25	5,493	250	8
VTPOZ35030	3,5 x 30	5,889	250	8
VTPOZ35035	3,5 x 35	4,667	150	8
VTPOZ35040	3,5 x 40	4,848	150	8
VTPOZ35050	3,5 x 50	4,379	100	8
VTPOZ40016	3 x 16	5,221	250	8
VTPOZ40020	3 x 20	5,977	250	8
VTPOZ40025	4 x 25	6,606	250	8
VTPOZ40030	4 x 30	5,404	175	8
VTPOZ40035	4 x 35	5,226	150	8
VTPOZ40040	4 x 40	5,625	150	8
VTPOZ40045	4 x 45	6,868	150	8
VTPOZ40050	4 x 50	5,168	100	8
VTPOZ40060	4 x 60	6,029	100	8
VTPOZ45030	4,5 x 30	6,047	150	8
VTPOZ45035	4,5 x 35	6,626	150	8
VTPOZ45040	4,5 x 40	7,126	150	8
VTPOZ45045	4,5 x 45	5,387	90	8
VTPOZ45050	4,5 x 50	6,428	100	8
VTPOZ45060	4,5 x 60	6,012	80	8
VTPOZ45070	4,5 x 70	5,445	60	8
VTPOZ50030	5 x 30	5,066	100	8
VTPOZ50035	5 x 35	5,514	100	8
VTPOZ50040	5 x 40	6,047	100	8
VTPOZ50050	5 x 50	7,243	100	8
VTPOZ50060	5 x 60	7,182	80	8
VTPOZ50070	5 x 70	4,255	35	8
VTPOZ50080	5 x 80	3,981	30	8
VTPOZ50090	5 x 90	4,454	30	8
VTPOZ60060	6 x 60	7,156	60	8
VTPOZ60070	6 x 70	4,642	30	8
VTPOZ60080	6 x 80	5,154	30	8



Available in different coatings. Ask for price and delivery time.

TP-TO

Bicromatado. Huella TX



Disponible en varios recubrimientos. Consulte precio y plazo de entrega.



CÓDIGO	MEDIDA	€/100	UD. MIN. VENTA	UD. MIN. VENTA	UD. MIN. VENTA
TPTO30025	3 x 25	1,902	TX10	2.000	1.000 12.000
TPTO30030	3 x 30	2,058	TX10	2.000	1.000 12.000
• TPTO35015	3,5 x 15	1,678	TX15	2.000	1.000 24.000
• TPTO35017	3,5 x 17	1,717	TX15	2.000	1.000 24.000
• TPTO35020	3,5 x 20	1,996	TX15	2.000	1.000 12.000
TPTO35025	3,5 x 25	2,087	TX15	2.000	1.000 12.000
TPTO35030	3,5 x 30	2,404	TX15	2.000	1.000 12.000
TPTO35040	3,5 x 40	3,285	TX15	1.000	500 6.000
TPTO35050	3,5 x 50	3,922	TX15	1.000	500 3.000
• TPTO40020	4 x 20	2,297	TX20	2.000	1.000 12.000
• TPTO40025	4 x 25	2,860	TX20	2.000	1.000 12.000
TPTO40030	4 x 30	3,214	TX20	1.000	500 6.000
TPTO40035	4 x 35	3,682	TX20	1.000	500 6.000
TPTO40040	4 x 40	3,871	TX20	1.000	500 6.000
TPTO40045	4 x 45	4,599	TX20	1.000	500 6.000
TPTO40050	4 x 50	5,198	TX20	500	250 3.000
TPTO40060	4 x 60	6,063	TX20	500	250 3.000
TPTO40070	4 x 70	7,552	TX20	500	250 1.500
• TPTO45030	4,5 x 30	3,930	TX20	1.000	500 6.000
TPTO45035	4,5 x 35	4,713	TX20	1.000	500 6.000
TPTO45040	4,5 x 40	5,017	TX20	1.000	500 6.000
TPTO45045	4,5 x 45	5,815	TX20	500	250 3.000
TPTO45050	4,5 x 50	6,093	TX20	500	250 3.000
TPTO45060	4,5 x 60	7,770	TX20	500	250 3.000
TPTO45070	4,5 x 70	9,032	TX20	500	250 1.500
• TPTO50030	5 x 30	5,107	TX25	500	250 6.000

CÓDIGO	MEDIDA	€/100	UD. MIN. VENTA	UD. MIN. VENTA	UD. MIN. VENTA
TPTO50035	5 x 35	5,952	TX25	500	250 6.000
TPTO50040	5 x 40	6,317	TX25	500	250 3.000
TPTO50045	5 x 45	7,317	TX25	500	250 3.000
TPTO50050	5 x 50	8,057	TX25	500	250 3.000
TPTO50060	5 x 60	9,166	TX25	500	250 1.500
TPTO50070	5 x 70	11,567	TX25	200	100 1.200
TPTO50080	5 x 80	13,353	TX25	200	100 1.200
TPTO50090	5 x 90	14,811	TX25	200	100 1.200
TPTO50100	5 x 100	16,037	TX25	200	100 1.200
TPTO50120	5 x 120	21,334	TX25	200	100 1.200
TPTO60060	6 x 60	13,153	TX30	500	250 1.500
TPTO60070	6 x 70	15,823	TX30	200	100 1.200
TPTO60080	6 x 80	17,621	TX30	200	100 1.200
TPTO60090	6 x 90	20,435	TX30	200	100 1.200
TPTO60100	6 x 100	22,442	TX30	100	100 1.200
TPTO60110	6 x 110	28,184	TX30	100	100 600
TPTO60120	6 x 120	29,482	TX30	100	100 600
TPTO60130	6 x 130	33,339	TX30	100	100 600
TPTO60140	6 x 140	35,549	TX30	100	100 600
TPTO60150	6 x 150	40,224	TX30	100	100 600
TPTO60160	6 x 160	47,626	TX30	100	100 400
TPTO60180	6 x 180	61,610	TX30	100	100 300
TPTO60200	6 x 200	75,688	TX30	100	100 300
TPTO60220	6 x 220	92,112	TX30	100	100 300

• Medidas sin homologar

Caja ventana

CÓDIGO	MEDIDA	€/CAJA	PCS	CAJAS
VTPTO30025	3 x 25	5,850	250	8
VTPTO30030	3 x 30	6,398	250	8
VTPTO35015	3,5 x 15	5,451	250	8
VTPTO35020	3,5 x 20	6,201	250	8
VTPTO35025	3,5 x 25	6,696	250	8
VTPTO35030	3,5 x 30	7,456	250	8
VTPTO35040	3,5 x 40	6,189	150	8
VTPTO35050	3,5 x 50	5,365	100	8
VTPTO40020	4 x 20	7,402	250	8
VTPTO40025	4 x 25	8,980	250	8
VTPTO40030	4 x 30	7,361	175	8
VTPTO40035	4 x 35	7,013	150	8
VTPTO40040	4 x 40	7,583	150	8
VTPTO40045	4 x 45	8,528	150	8
VTPTO40050	4 x 50	6,673	100	8
VTPTO40060	4 x 60	7,383	100	8
VTPTO45030	4,5 x 30	7,505	150	8
VTPTO45035	4,5 x 35	8,285	150	8
VTPTO45040	4,5 x 40	9,477	150	8
VTPTO45045	4,5 x 45	6,660	90	8
VTPTO45050	4,5 x 50	8,308	100	8
VTPTO45060	4,5 x 60	7,629	80	8
VTPTO45070	4,5 x 70	6,793	60	8
VTPTO50030	5 x 30	6,377	100	8
VTPTO50035	5 x 35	7,133	100	8
VTPTO50040	5 x 40	8,395	100	8
VTPTO50050	5 x 50	9,478	100	8
VTPTO50060	5 x 60	8,695	80	8
VTPTO50070	5 x 70	5,413	35	8
VTPTO50080	5 x 80	5,300	30	8
VTPTO50090	5 x 90	5,795	30	8
VTPTO60060	6 x 60	9,077	60	8
VTPTO60070	6 x 70	5,865	30	8
VTPTO60080	6 x 80	7,003	30	8



Tirafondos de cabeza avellanada

TP

INOXIDABLE



TP-A2

Inoxidable A2. Huella PZ

CÓDIGO	MEDIDA	€/100			
TPA230016	3 x 16	4,330	PZ1	200	9.000
TPA230025	3 x 25	5,537	PZ1	200	9.000
TPA235020	3,5 x 20	7,295	PZ2	200	9.000
TPA235025	3,5 x 25	7,882	PZ2	200	9.000
TPA235030	3,5 x 30	9,610	PZ2	200	9.000
TPA235040	3,5 x 40	13,663	PZ2	200	4.800
TPA240030	4 x 30	11,681	PZ2	200	4.800
TPA240040	4 x 40	13,793	PZ2	200	4.800
TPA240050	4 x 50	21,645	PZ2	200	4.800
TPA245030	4,5 x 30	13,716	PZ2	200	4.800
TPA245050	4,5 x 50	21,909	PZ2	200	2.400
TPA250050	5 x 50	27,632	PZ2	200	2.400
TPA250070	5 x 70	37,658	PZ2	200	2.400



Tirafundo de cabeza alomada, bicromatado. Huella PZ

TR-PO

MADERA



CÓDIGO	MEDIDA	€/100			
TRPO30016	3 x 16	1,915	PZ1	1.000	24.000
TRPO30020	3 x 20	1,966	PZ1	1.000	12.000
TRPO35016	3,5 x 16	2,158	PZ2	1.000	24.000
TRPO35020	3,5 x 20	2,733	PZ2	1.000	12.000
TRPO35025	3,5 x 25	2,797	PZ2	1.000	12.000
TRPO35030	3,5 x 30	3,087	PZ2	1.000	12.000
TRPO35035	3,5 x 35	3,240	PZ2	500	6.000
TRPO40016	4 x 16	3,003	PZ2	1.000	12.000
TRPO40020	4 x 20	3,190	PZ2	1.000	12.000
TRPO40025	4 x 25	3,559	PZ2	1.000	12.000
TRPO40030	4 x 30	3,943	PZ2	500	6.000
TRPO40035	4 x 35	4,260	PZ2	500	6.000
TRPO40040	4 x 40	4,847	PZ2	500	6.000
TRPO40050	4 x 50	6,287	PZ2	250	3.000
TRPO45016	4,5 x 16	3,944	PZ2	500	12.000
TRPO45020	4,5 x 20	4,100	PZ2	500	8.000
TRPO45025	4,5 x 25	4,757	PZ2	500	6.000
TRPO45030	4,5 x 30	5,440	PZ2	500	6.000
TRPO45035	4,5 x 35	6,160	PZ2	500	6.000
TRPO45040	4,5 x 40	6,223	PZ2	500	3.000
TRPO45045	4,5 x 45	7,117	PZ2	250	3.000
TRPO50020	5 x 20	5,434	PZ2	500	6.000
TRPO50030	5 x 30	6,378	PZ2	250	6.000
TRPO50040	5 x 40	7,370	PZ2	250	3.000
TRPO50050	5 x 50	9,398	PZ2	250	3.000



DIN-571

Tornillo con rosca para madera y aglomerado. Cabeza hexagonal

DIN-571

Zincado



Disponible en varios recubrimientos. Consulte precio y plazo de entrega.

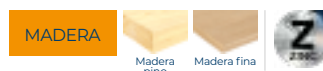

CÓDIGO	MEDIDA	€/100				CÓDIGO	MEDIDA	€/100			
• TB05030	5 x 30	4,907	8	200	4.800	TB08140	8 x 140	42,584	13	100	400
• TB05040	5 x 40	6,497	8	200	2.400	TB08150	8 x 150	45,757	13	100	400
TB05050	5 x 50	7,321	8	200	2.400	TB08160	8 x 160	48,487	13	100	400
TB05060	5 x 60	8,644	8	200	2.400	TB08180	8 x 180	60,280	13	100	300
• TB06025	6 x 25	5,789	10	200	2.400	TB08200	8 x 200	65,977	13	100	300
• TB06030	6 x 30	6,570	10	200	2.400	• TB10040	10 x 40	27,391	17	100	600
• TB06035	6 x 35	7,304	10	200	2.400	• TB10050	10 x 50	29,789	17	100	600
• TB06040	6 x 40	7,508	10	200	2.400	• TB10060	10 x 60	33,150	17	100	600
• TB06045	6 x 45	8,410	10	200	2.400	• TB10070	10 x 70	36,636	17	100	600
• TB06050	6 x 50	8,893	10	200	2.400	• TB10080	10 x 80	40,413	17	100	400
TB06060	6 x 60	10,592	10	200	1.200	• TB10090	10 x 90	47,798	17	100	400
TB06070	6 x 70	12,190	10	200	1.200	TB10100	10 x 100	48,413	17	100	400
TB06080	6 x 80	14,076	10	200	1.200	TB10110	10 x 110	54,269	17	50	300
TB06090	6 x 90	16,401	10	100	1.200	TB10120	10 x 120	58,390	17	50	300
TB06100	6 x 100	18,351	10	100	1.200	TB10130	10 x 130	63,677	17	50	300
TB06110	6 x 110	21,498	10	100	1.200	TB10140	10 x 140	71,217	17	50	200
TB06120	6 x 120	21,783	10	100	800	TB10150	10 x 150	80,494	17	50	200
TB07030	7 x 30	11,224	12	200	2.400	TB10160	10 x 160	85,926	17	50	200
TB07040	7 x 40	13,283	12	200	1.600	TB10180	10 x 180	96,223	17	50	150
TB07050	7 x 50	14,729	12	200	1.200	TB10200	10 x 200	103,593	17	50	150
TB07060	7 x 60	16,840	12	100	1.200	• TB12060	12 x 60	50,846	19	50	300
TB07070	7 x 70	19,746	12	100	1.200	• TB12070	12 x 70	55,948	19	50	300
TB07080	7 x 80	21,997	12	100	800	• TB12080	12 x 80	59,750	19	50	300
TB07090	7 x 90	22,817	12	100	400	• TB12090	12 x 90	66,327	19	50	300
TB07100	7 x 100	25,290	12	100	600	• TB12100	12 x 100	72,259	19	50	300
TB07120	7 x 120	30,611	12	100	600	TB12120	12 x 120	86,051	19	50	200
• TB08030	8 x 30	12,750	13	200	1.200	TB12130	12 x 130	94,361	19	50	100
• TB08040	8 x 40	14,773	13	200	1.200	TB12140	12 x 140	100,495	19	50	100
• TB08045	8 x 45	16,187	13	200	1.200	TB12150	12 x 150	107,283	19	50	200
• TB08050	8 x 50	16,453	13	200	1.200	TB12160	12 x 160	117,450	19	50	200
• TB08060	8 x 60	18,220	13	200	1.200	TB12180	12 x 180	134,649	19	50	150
• TB08070	8 x 70	20,716	13	200	800	TB12200	12 x 200	151,792	19	50	150
TB08080	8 x 80	23,357	13	200	800	TB12220	12 x 220	173,113	19	50	100
TB08090	8 x 90	28,600	13	100	600	TB12240	12 x 240	185,668	19	50	100
TB08100	8 x 100	30,926	13	100	600	TB12260	12 x 260	203,542	19	50	100
TB08110	8 x 110	33,232	13	100	600	• TB14100	14 x 100	133,676	22	50	200
TB08120	8 x 120	34,846	13	100	600						
TB08130	8 x 130	40,947	13	100	400						

• Medidas sin homologar

Blíster

CÓDIGO	MEDIDA	€/BOLSA	PCS	BOLSAS
BZTB05030	5 x 30	2,040	4	20
BZTB05040	5 x 40	2,040	4	20
BZTB05050	5 x 50	2,040	4	20
BZTB06030	6 x 30	2,040	4	20
BZTB06040	6 x 40	2,040	4	20
BZTB06050	6 x 50	2,040	4	20
BZTB06060	6 x 60	2,040	4	20
BZTB06070	6 x 70	2,040	4	20
BZTB06080	6 x 80	2,040	4	20
BZTB07050	7 x 50	2,040	4	20
BZTB07060	7 x 60	2,040	4	20
BZTB07070	7 x 70	2,040	4	20
BZTB08040	8 x 40	2,040	4	20
BZTB08050	8 x 50	2,040	4	20
BZTB08060	8 x 60	2,040	4	20
BZTB08070	8 x 70	2,040	4	20
BZTB08080	8 x 80	2,040	4	15
BZTB08090	8 x 90	2,040	2	15
BZTB08100	8 x 100	2,040	2	15
BZTB10050	10 x 50	2,040	2	15
BZTB10060	10 x 60	2,040	2	15
BZTB10080	10 x 80	2,040	2	15

Caja ventana

CÓDIGO	MEDIDA	€/CAJA	PCS	CAJAS
VTB05040	5 x 40	4,315	50	8
VTB05050	5 x 50	5,072	50	8
VTB06040	6 x 40	5,090	50	8
VTB06050	6 x 50	4,775	40	8
VTB06060	6 x 60	4,181	30	8
VTB07050	7 x 50	4,775	25	8
VTB07060	7 x 60	4,455	20	8
VTB07070	7 x 70	5,121	20	8
VTB07080	7 x 80	5,520	20	8
VTB08050	8 x 50	4,280	20	8
VTB08060	8 x 60	4,891	20	8
VTB08070	8 x 70	5,556	20	8
VTB08080	8 x 80	4,650	15	8
VTB08090	8 x 90	4,059	10	8
VTB08100	8 x 100	3,936	10	8
VTB10070	10 x 70	4,789	10	8
VTB10080	10 x 80	5,079	10	8
VTB10090	10 x 90	5,887	10	8
VTB10100	10 x 100	6,199	10	8



Tornillo con rosca para madera y aglomerado. Cabeza hexagonal

DIN-571

INOXIDABLE



DIN-571 A2

Inoxidable A2

CÓDIGO	MEDIDA	€/100			
• TBA206040	6 x 40	29,117	10	100	2.400
• TBA206050	6 x 50	35,387	10	100	1.200
• TBA206060	6 x 60	42,357	10	100	1.200
• TBA206070	6 x 70	45,490	10	100	1.200
• TBA208050	8 x 50	65,997	13	100	1.200
• TBA208060	8 x 60	75,710	13	100	1.200
• TBA208070	8 x 70	87,377	13	100	600
• TBA208080	8 x 80	93,583	13	100	600
• TBA210080	10 x 80	163,663	17	100	400

• Medidas sin homologar



MADERA



571 TR

Con rosca completa

CÓDIGO	MEDIDA	€/100			
TBR06050	6 x 50	9,337	10	200	1.200
TBR06060	6 x 60	10,804	10	200	1.200
TBR06070	6 x 70	12,433	10	200	1.200
TBR08050	8 x 50	16,782	13	200	1.200
TBR08060	8 x 60	18,584	13	200	800
TBR08070	8 x 70	21,130	13	200	800
TBR08080	8 x 80	23,824	13	200	800
TBR10060	10 x 60	33,813	17	100	600
TBR10080	10 x 80	41,221	17	100	400



Tornillo inviolable. Huella TX

INV

MADERA



INV Z

Zincado

CÓDIGO	MEDIDA	€/100		UD. MIN. VENTA		
• INVZ6040	6 x 40	26,510	TX40	200	100	1.200
• INVZ6050	6 x 50	28,637	TX40	200	100	1.200
• INVZ6060	6 x 60	30,150	TX40	200	100	600
• INVZ6070	6 x 70	34,837	TX40	200	100	600
• INVZ7030	7 x 30	24,123	TX40	200	100	1.200
• INVZ7040	7 x 40	25,095	TX40	200	100	1.200
• INVZ7050	7 x 50	26,380	TX40	200	100	1.200
• INVZ7060	7 x 60	29,711	TX40	200	100	600
• INVZ7070	7 x 70	30,558	TX40	200	100	600
• INVZ7080	7 x 80	36,979	TX40	200	100	600
• INVZ7090	7 x 90	42,578	TX40	200	100	600
• INVZ7105	7 x 105	56,730	TX40	200	100	600
• INVZ7120	7 x 120	65,490	TX40	200	100	600
• INVZ7140	7 x 140	77,073	TX40	200	100	600
• INVZ7165	7 x 165	99,610	TX40	200	100	300
• INVZ7205	7 x 205	145,147	TX40	200	100	300

• Medidas sin homologar



Disponible en varios recubrimientos. Consulte precio y plazo de entrega.

Caja ventana

CÓDIGO	MEDIDA	€/CAJA	PCS	CAJAS
VINVZ7060	7 x 60	6,217	15	8
VINVZ7070	7 x 70	6,300	15	8

INV



Tornillo inviolable. Huella TX

INV A2

Inoxidable A2

INOXIDABLE



CÓDIGO	MEDIDA	€/100			
• INVA27050	7 x 50	119,867	TX40	100	1.200
• INVA27060	7 x 60	142,010	TX40	100	600
• INVA27070	7 x 70	157,617	TX40	100	600
• INVA27080	7 x 80	170,147	TX40	100	600

• Medidas sin homologar





INV N

Zincado negro

MADERA



CÓDIGO	MEDIDA	€/100			
• INVN6040	6 x 40	30,525	TX40	100	1.200
• INVN6050	6 x 50	32,161	TX40	100	1.200
• INVN6060	6 x 60	34,894	TX40	100	600
• INVN6070	6 x 70	38,277	TX40	100	600
• INVN7030	7 x 30	27,415	TX40	100	1.200
• INVN7040	7 x 40	29,244	TX40	100	1.200
• INVN7050	7 x 50	33,343	TX40	100	1.200
• INVN7060	7 x 60	39,382	TX40	100	600
• INVN7070	7 x 70	39,888	TX40	100	600
• INVN7080	7 x 80	46,537	TX40	100	600
• INVN7090	7 x 90	50,957	TX40	100	600

• Medidas sin homologar



Caja ventana

CÓDIGO	MEDIDA	€/CAJA	PCS	CAJAS
VINVN7060	7 x 60	8,382	15	8
VINVN7070	7 x 70	8,850	15	8

ESTRINV Z

Estrella inviolable. Zincada

MADERA



CÓDIGO	MEDIDA	€/100	UD. MIN. VENTA	
ESTRINV40Z	ZINC	4,613	400	100

ESTRINV N

Estrella inviolable. Negra

MADERA



CÓDIGO	MEDIDA	€/100	UD. MIN. VENTA	
ESTRINV40N	NEGRA/BLACK/NOIRE	5,410	400	100



Tornillo de ensamblar

TRE

MADERA



CÓDIGO	MEDIDA	€/100		
TREZ05050	Ø5 x 50	8,593	300	1.800
TREZ07050	Ø7 x 50	14,350	200	2.400



Blíster

CÓDIGO	MEDIDA	€/BOLSA	PCS BOLSA	BOLSAS
BZTREZ05050	Ø5 x 50	2,040	4	20
BZTREZ07050	Ø7 x 50	2,040	4	20

TRE-Z

Zincado



MADERA



CÓDIGO	MEDIDA	€/100		
TREPV05050	Ø5 x 50	9,820	300	1.800
TREPV07050	Ø7 x 50	14,350	200	2.400



Blíster

CÓDIGO	MEDIDA	€/BOLSA	PCS BOLSA	BOLSAS
BZTREP05050	Ø5 x 50	2,040	4	20
BZTREP07050	Ø7 x 50	2,040	4	20

TRE-PV

Pavonado



Tornillo cubierta metal madera

FS

MADERA



CÓDIGO	MEDIDA	€/100			
AFZN144819	4,8 x 19 P14	15,667	8	250	3.000
AFZN144828	4,8 x 28 P14	18,400	8	250	3.000
AFZN144835	4,8 x 35 P14	19,203	8	250	3.000

FS Z

Zincado



MADERA



CÓDIGO	MEDIDA	€/100			
AFRT144819	4,8 x 19 P14 3009	19,113	8	250	3.000
AFRT144828	4,8 x 28 P14 3009	21,210	8	250	3.000
AFRT144835	4,8 x 35 P14 3009	25,347	8	250	3.000

FS 3009

RAL 3009. Rojo teja



FS

Tornillo cubierta metal madera

FS 3011

RAL 3011. Rojo pardo





CÓDIGO	MEDIDA	€/100			
AFRD144819	4,8 x 19 P14 3011	19,113	8	250	3.000
AFRD144828	4,8 x 28 P14 3011	21,210	8	250	3.000
AFRD144835	4,8 x 35 P14 3011	25,347	8	250	3.000

FS 5010

RAL 5010. Azul genciana





CÓDIGO	MEDIDA	€/100			
• AFAZ144819	4,8 x 19 P14 5010	19,113	8	250	3.000
• AFAZ144828	4,8 x 28 P14 5010	21,210	8	250	3.000
• AFAZ144835	4,8 x 35 P14 5010	25,347	8	250	3.000

• Hasta fin de existencias

FS 6005

RAL 6005. Verde musgo





CÓDIGO	MEDIDA	€/100			
AFVE144819	4,8 x 19 P14 6005	19,113	8	250	3.000
AFVE144828	4,8 x 28 P14 6005	21,210	8	250	3.000
AFVE144835	4,8 x 35 P14 6005	25,347	8	250	3.000

FS 8004

RAL 8004. Marrón cobre





CÓDIGO	MEDIDA	€/100			
AFMC144819	4,8 x 19 P14 8004	19,113	8	250	3.000
AFMC144828	4,8 x 28 P14 8004	21,210	8	250	3.000
AFMC144835	4,8 x 35 P14 8004	25,347	8	250	3.000

FS 8017

RAL 8017. Marrón chocolate



CÓDIGO	MEDIDA	€/100			
AFMD144819	4,8 x 19 P14 8017	19,113	8	250	3.000
AFMD144828	4,8 x 28 P14 8017	21,210	8	250	3.000
AFMD144835	4,8 x 35 P14 8017	25,347	8	250	3.000



Tornillo cubierta metal madera

FS



CÓDIGO	MEDIDA	€/100			
AFPG144819	4,8 x 19 P14 8019	19,113	8	250	3.000
AFPG144828	4,8 x 28 P14 8019	21,210	8	250	3.000
AFPG144835	4,8 x 35 P14 8019	25,347	8	250	3.000

FS 8019

RAL 8019. Gris pardo



CÓDIGO	MEDIDA	€/100			
AFGR144819	4,8 x 19 P14 9006	19,113	8	250	3.000
AFGR144828	4,8 x 28 P14 9006	21,210	8	250	3.000
AFGR144835	4,8 x 35 P14 9006	25,347	8	250	3.000

FS 9006

RAL 9006. Gris aluminio



CÓDIGO	MEDIDA	€/100			
AFBL144819	4,8 x 19 P14 9010	19,113	8	250	3.000
AFBL144828	4,8 x 28 P14 9010	21,210	8	250	3.000
AFBL144835	4,8 x 35 P14 9010	25,347	8	250	3.000

FS 9010

RAL 9010. Blanco



CÓDIGO	MEDIDA	€/100			
AFNE144819	4,8 x 19 P14 9011	19,113	8	250	3.000
AFNE144828	4,8 x 28 P14 9011	21,210	8	250	3.000
AFNE144835	4,8 x 35 P14 9011	25,347	8	250	3.000

FS 9011

RAL 9011. Negro



Tornillo de cabeza cilíndrica especial extraplana con rosca de doble hilo para aluminio.
Zincado y huella TX

FIMA



CÓDIGO	MEDIDA	€/100			
TFI4825	4,8 x 25	7,240	TX20	500	6.000
TFI4835	4,8 x 35	8,457	TX20	500	6.000
TFI4845	4,8 x 45	11,077	TX20	500	3.000
TFI4855	4,8 x 55	12,967	TX20	500	3.000
TFI4865	4,8 x 65	15,133	TX20	250	1.500
TFI4875	4,8 x 75	18,440	TX20	250	1.500
TFI4890	4,8 x 90	27,107	TX20	250	1.500



INDEX
A PERFECT FIXING

**PUNTAS, ALCAYATAS Y
HEMBRILLAS**



AL

Alcayatas



AL-RE

Alcayata redonda





MULTIMATERIAL



CÓDIGO	MEDIDA	€/100		
ALRE20015	2 x 15 x 7	0,857	500	22.500
ALRE25020	2,5 x 20 x 12	1,857	500	22.500
ALRE25025	2,5 x 25 x 12	2,037	500	12.000
ALRE25030	2,5 x 30 x 12	2,647	300	7.200
ALRE35050	3,5 x 50 x 14	6,863	300	3.600
ALRE35040	3,5 x 40 x 14	6,520	300	7.200
ALRE40060	4 x 60 x 16	9,430	200	2.400
ALRE40070	4 x 70 x 16	11,873	200	1.200
ALRE40080	4 x 80 x 16	13,263	100	1.200

Blíster

CÓDIGO	MEDIDA	€/BOLSA	PCS 	BOLSAS 
BZALRE20015	2 x 15 x 7	2,040	25	20
BZALRE25020	2,5 x 20 x 12	2,040	25	20
BZALRE25025	2,5 x 25 x 12	2,040	25	20
BZALRE25030	2,5 x 30 x 12	2,040	15	20
BZALRE35040	3,5 x 40 x 14	2,040	15	20
BZALRE35050	3,5 x 50 x 14	2,040	15	20
BZALRE40060	4 x 60 x 16	2,040	10	20
BZALRE40070	4 x 70 x 16	2,040	6	20
BZALRE40080	4 x 80 x 16	2,040	4	20



AL-PL

Alcayata plana

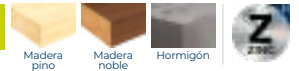

MULTIMATERIAL





CÓDIGO	MEDIDA	€/100		
ALPL45060	4,5 x 60 x 20	49,547	100	2.400
ALPL45080	4,5 x 80 x 20	62,727	100	1.200
ALPL45100	4,5 x 100 x 20	87,130	100	600
ALPL50120	5 x 120 x 25	128,950	100	400

Alcayatas

AL



CÓDIGO	€/100	ØD	L1	B	L2	D		
ALRO14025	2,960	2.6	17	10	10	2.6	500	22.500
ALRO16030	3,350	3.1	20	12	10	3.1	300	13.500
ALRO17040	4,376	3.5	29	17	13	3.5	300	7.200
ALRO18040	5,367	3.7	28	17	14	3.7	300	7.200
ALRO18050	5,772	3.7	37	22	15	3.7	300	7.200
ALRO19050	7,195	4.4	37	22	15	4.4	200	4.800
ALRO19060	7,573	4.4	46	28	17	4.4	200	4.800
ALRO19070	9,302	4.4	55	33	18	4.4	200	2.400
ALRO20060	10,073	5	44	26	20	5	200	2.400
ALRO20070	10,580	5	53	32	20	5	200	1.600
ALRO20080	11,611	5	63	38	21	5	200	2.400
ALRO21080	14,997	5.6	60	36	22	5.6	200	2.400
ALRO21090	16,456	5.6	70	42	22	5.6	200	800
ALRO22100	17,600	6	79	47	23	6	100	1.200
ALRO22110	21,677	6	86	52	23	6	100	1.200
ALRO22120	25,645	6	97	58	25	6	50	800
ALRO23130	34,712	7.8	105	63	25	7.8	50	600

AL-RO

Alcayata roscada

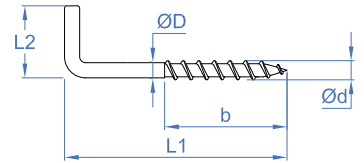



Blíster

CÓDIGO	MEDIDA	€/BOLSA	PCS BOLSA	BOLSAS
BZALRO14025	14x25 (2,6 x 17 x 10)	2,040	25	20
BZALRO16030	16x30 (3,1 x 20 x 10)	2,040	15	20
BZALRO17040	17x40 (3,5 x 29 x 13)	2,040	15	20
BZALRO18040	18x40 (3,7 x 28 x 14)	2,040	15	20
BZALRO18050	18x50 (3,7 x 37 x 15)	2,040	15	20
BZALRO19050	19x50 (4,4 x 37 x 15)	2,040	10	20
BZALRO19060	19x60 (4,4 x 46 x 17)	2,040	10	20
BZALRO19070	19x70 (4,4 x 55 x 18)	2,040	10	20
BZALRO20060	20x60 (5 x 44 x 20)	2,040	8	20
BZALRO20070	20x70 (5 x 53 x 20)	2,040	8	20
BZALRO21080	21x80 (5,6 x 60 x 22)	2,040	6	20
BZALRO21090	21x90 (5,6 x 70 x 22)	2,040	6	20
BZALRO22100	22x100 (6 x 79 x 23)	2,040	4	20
BZALRO22110	22x110 (6 x 86 x 23)	2,040	2	20
BZALRO22120	22x120 (6 x 97 x 25)	2,040	2	20
BZALRO23130	23x130 (7,8 x 105 x 25)	2,040	2	20

Caja ventana

CÓDIGO	MEDIDA	€/CAJA	PCS CAJAS	
VALRO14025	14x25 (2,6 x 17 x 10)	4,950	125	8
VALRO16030	16x30 (3,1 x 20 x 10)	3,379	75	8
VALRO17040	17x40 (3,5 x 29 x 13)	4,410	75	8
VALRO18040	18x40 (3,7 x 28 x 14)	5,383	75	8
VALRO18050	18x50 (3,7 x 37 x 15)	6,978	75	8
VALRO19050	19x50 (4,4 x 37 x 15)	5,799	60	8
VALRO19060	19x60 (4,4 x 46 x 17)	6,105	60	8
VALRO19070	19x70 (4,4 x 55 x 18)	7,500	60	8
VALRO20060	20x60 (5 x 44 x 20)	8,120	60	8
VALRO20070	20x70 (5 x 53 x 20)	8,530	60	8
VALRO20080	20x80 (5 x 63 x 21)	9,361	60	8
VALRO21080	21x80 (5,6 x 60 x 22)	14,110	50	8
VALRO21090	21x90 (5,6 x 70 x 22)	15,480	40	8
VALRO22100	22x100 (6 x 79 x 23)	9,235	35	8
VALRO22110	22x110 (6 x 86 x 23)	10,994	35	8
VALRO22120	22x120 (6 x 97 x 25)	8,014	20	8
VALRO23130	23x130 (7,8 x 105 x 25)	9,640	20	8



CÓDIGO	€/100	ØD	L1	B	L2	D		
ALROB16030	7,257	3.1	20	10	10	3.1	300	13.500
ALROB17040	9,173	3.5	29	13	13	3.5	300	7.200
ALROB18050	13,837	3.7	37	18	15	3.7	300	7.200
ALROB19060	15,900	4.4	46	24	17	4.4	200	4.800

AL-RO B

Alcayata roscada lacada blanca



Blíster

CÓDIGO	MEDIDA	€/BOLSA	PCS BOLSA	BOLSAS
BZALROB1630	16x30 (3,1 x 20 x 10)	2,582	15	20
BZALROB1740	17x40 (3,5 x 29 x 13)	2,582	15	20
BZALROB1850	18x50 (3,7 x 37 x 15)	2,582	15	20
BZALROB1960	19x60 (4,4 x 46 x 17)	2,582	10	20

HB

Hembrillas

AL-HC

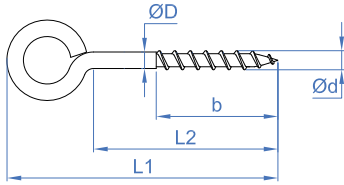

Hembrilla cerrada



 Info
Técnica
P. 409

MADERA



CÓDIGO	€/100	ØD	L1	B	L2	D		
ALHC14025	2,960	2.6	18	7	10	2.6	500	22.500
ALHC16030	3,350	3.1	22	9	12	3.1	300	13.500
ALHC17040	4,376	3.5	26	10	14	3.5	300	7.200
ALHC18040	5,367	4.1	28	10	15	4.1	300	7.200
ALHC18050	5,772	4.1	34	12	20	3.7	300	7.200
ALHC19050	7,195	4.4	33	12	18	4.4	200	4.800
ALHC19060	7,573	4.4	39	15	22	4.4	200	4.800
ALHC19070	9,302	4.4	41	15	24	4.4	200	4.800
ALHC20050	9,442	5	35	12	19	5	200	4.800
ALHC20060	10,073	5	39	12	21	5	200	3.200
ALHC20070	10,580	5	44	14	26	5	200	2.400
ALHC20080	11,611	5	50	18	30	5	200	2.400
ALHC21070	13,725	5.6	43	14	23	5.6	200	2.400
ALHC21080	14,997	5.6	48	14	28	5.6	200	2.400
ALHC21090	16,456	5.6	56	14	32	5.6	200	1.200
ALHC21100	17,600	5.6	61	18	37	5.6	100	1.200
ALHC22110	21,677	6	69	24	43	6	100	1.200
ALHC22120	25,645	6	74	29	48	6	50	600
ALHC23130	34,712	6.3	83	35	55	6.3	50	600

 Blíster

CÓDIGO	MEDIDA	€/BOLSA	PCS	BOLSAS
BZALHC14025	14x25 (2,6 x 18 x 7)	2,040	25	20
BZALHC16030	16x30 (3,1 x 22 x 9)	2,040	15	20
BZALHC17040	17x40 (3,5 x 26 x 10)	2,040	15	20
BZALHC18040	18x40 (4,1 x 28 x 10)	2,040	15	20
BZALHC18050	18x50 (3,7 x 34 x 12)	2,040	15	20
BZALHC19050	19x50 (4,4 x 33 x 12)	2,040	10	20
BZALHC19060	19x60 (4,4 x 39 x 15)	2,040	10	20
BZALHC19070	19x70 (4,4 x 41 x 15)	2,040	10	20
BZALHC20060	20x60 (5 x 39 x 12)	2,040	8	20
BZALHC20070	20x70 (5 x 44 x 14)	2,040	8	20
BZALHC20080	20x80 (5 x 50 x 18)	2,040	8	15
BZALHC21080	21x80 (5,6 x 48 x 14)	2,040	6	15
BZALHC21090	21x90 (5,6 x 56 x 14)	2,040	6	15
BZALHC21100	21x100 (5,6 x 61 x 18)	2,040	4	20
BZALHC22110	22x110 (6 x 69 x 24)	2,040	2	20
BZALHC22120	22x120 (6 x 74 x 29)	2,040	2	20
BZALHC23130	23x130 (6,3 x 83 x 35)	2,040	2	20



AL-HC B

Hembrilla cerrada roscada lacada blanca



MADERA



CÓDIGO	€/100	ØD	L1	B	L2	D		
ALHCB16030	7,257	3.1	22	9	12	3.1	300	13.500
ALHCB17040	9,173	3.5	26	10	14	3.5	300	7.200
ALHCB18050	13,837	3.7	34	12	20	3.7	300	7.200
ALHCB19060	15,900	4.4	39	15	22	4.4	200	4.800

 Blíster

CÓDIGO	MEDIDA	€/BOLSA	PCS	BOLSAS
BZALHCB1630	16x30 (3,1 x 22 x 9)	2,582	15	20
BZALHCB1740	17x40 (3,5 x 26 x 10)	2,582	15	20
BZALHCB1850	18x50 (3,7 x 34 x 12)	2,582	15	20
BZALHCB1960	19x60 (4,4 x 39 x 15)	2,582	10	20



Hembrillas

HB



AL-HA

Hembrilla abierta

CÓDIGO	€/100	ØD	L1	B	L2	D		
ALHA14025	2,960	2.6	18	7	10	2.6	500	22.500
ALHA16030	3,350	3.1	22	9	12	3.1	300	13.500
ALHA17040	4,376	3.5	27	10	14	3.5	300	7.200
ALHA18040	5,367	4.1	29	10	15	4.1	300	7.200
ALHA18050	5,772	4.1	38	12	20	4.1	300	3.600
ALHA19050	7,195	4.4	35	12	18	4.4	200	4.800
ALHA19060	7,573	4.4	42	15	22	4.4	200	4.800
ALHA19070	9,302	4.4	44	15	24	4.4	200	2.400
ALHA20050	9,442	5	39	12	19	5	200	2.400
ALHA20060	10,073	5	41	12	21	5	200	2.400
ALHA20070	10,580	5	48	14	26	5	200	2.400
ALHA20080	11,611	5	54	18	30	5	200	2.400
ALHA21070	13,725	5.6	49	14	23	5.6	200	2.400
ALHA21080	14,997	5.6	54	14	28	5.6	200	2.400
ALHA21090	16,456	5.6	60	14	32	5.6	200	1.200
ALHA21100	17,600	5.6	66	18	37	5.6	100	1.200
ALHA22110	21,677	6	76	24	43	6	100	1.200
ALHA22120	25,645	6	81	29	48	6	50	600
ALHA23130	34,712	6.3	89	35	55	6.3	50	600

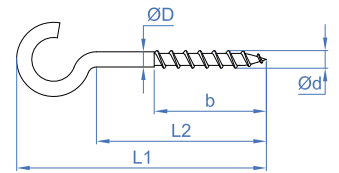



 Blíster

CÓDIGO	MEDIDA	€/BOLSA	PCS 	BOLSAS 
BZALHA14025	14x25 (2,6 x 18 x 7)	2,040	25	20
BZALHA16030	16x30 (3,1 x 22 x 9)	2,040	15	20
BZALHA17040	17x40 (3,5 x 26 x 10)	2,040	15	20
BZALHA18040	18x40 (4,1 x 29 x 10)	2,040	15	20
BZALHA18050	18x50 (4,1 x 34 x 12)	2,040	15	20
BZALHA19050	19x50 (4,4 x 33 x 12)	2,040	10	20
BZALHA19060	19x60 (4,4 x 39 x 15)	2,040	10	20
BZALHA19070	19x70 (4,4 x 41 x 15)	2,040	10	20
BZALHA20060	20x60 (5 x 39 x 12)	2,040	8	20
BZALHA20070	20x70 (5 x 44 x 14)	2,040	8	20
BZALHA20080	20x80 (5 x 50 x 18)	2,040	8	20
BZALHA21080	21x80 (5,6 x 48 x 14)	2,040	6	20
BZALHA21090	21x90 (5,6 x 56 x 14)	2,040	6	20
BZALHA21100	21x100 (5,6 x 61 x 18)	2,040	5	15
BZALHA22110	22x110 (6 x 69 x 24)	2,040	2	15
BZALHA22120	22x120 (6 x 74 x 29)	2,040	2	15
BZALHA23130	23x130 (6,3 x 82 x 35)	2,040	2	15





AL-HA B

Hembrilla abierta roscada lacada blanca

CÓDIGO	€/100	ØD	L1	B	L2	D		
ALHAB16030	7,257	3.1	22	9	12	3.1	300	13.500
ALHAB17040	9,173	3.5	26	10	14	3.5	300	7.200
ALHAB18050	13,837	4.1	34	12	20	3.7	300	7.200
ALHAB19060	15,900	4.4	39	15	22	4.4	200	4.800



 Blíster

CÓDIGO	MEDIDA	€/BOLSA	PCS 	BOLSAS 
BZALHAB1630	16x30 (3,1 x 22 x 9)	2,582	15	20
BZALHAB1740	17x40 (3,5 x 26 x 10)	2,582	15	20
BZALHAB1850	18x50 (4,1 x 34 x 12)	2,582	15	20
BZALHAB1960	19x60 (4,4 x 39 x 15)	2,582	10	20

HB

Hembrillas



HC-RM

Hembrilla cerrada. Rosca métrica con tuerca



MULTIMATERIAL



CÓDIGO	MEDIDA	€/100		
HCRM03026	3 x 26	27,867	100	4.500
HCRM04035	4 x 35	30,960	100	2.400
HCRM05037	5 x 37	36,977	100	1.200
HCRM06050	6 x 50	74,820	100	1.200
HCRM08060	8 x 60	85,997	100	600
HCRM10065	10 x 65	154,793	50	300
HCRM12075	12 x 75	235,281	50	150

Blíster

CÓDIGO	MEDIDA	€/BOLSA	PCS 	BOLSAS 
BZHCRM03026	3 x 26	2,040	15	20
BZHCRM04035	4 x 35	2,040	15	20
BZHCRM05037	5 x 37	2,040	8	20
BZHCRM06050	6 x 50	2,040	6	20
BZHCRM08060	8 x 60	2,040	2	20
BZHCRM10065	10 x 65	2,040	2	20

HA-RM

Hembrilla abierta. Rosca métrica con tuerca



MULTIMATERIAL



CÓDIGO	MEDIDA	€/100		
HARM03026	3 x 26	27,867	100	4.500
HARM04035	4 x 35	30,960	100	2.400
HARM05037	5 x 37	36,977	100	1.200
HARM06050	6 x 50	74,820	100	1.200
HARM08060	8 x 60	85,997	50	300

Blíster

CÓDIGO	MEDIDA	€/BOLSA	PCS 	BOLSAS 
BZHARM03026	3 x 26	2,040	15	20
BZHARM04035	4 x 35	2,040	15	20
BZHARM05037	5 x 37	2,040	8	20
BZHARM06050	6 x 50	2,040	6	20
BZHARM08060	8 x 60	2,040	2	20

Puntas clavado



PC

MULTIMATERIAL



PA-CP

Puntas acero cabeza plana

CÓDIGO	MEDIDA	€/100		
PACP22520	2,25 x 20	1,205	500	22.500
PACP22525	2,25 x 25	1,394	500	22.500
PACP22530	2,25 x 30	1,610	500	12.000
PACP25040	2,50 x 40	2,616	500	12.000
PACP25050	2,50 x 50	2,760	500	6.000
PACP29050	2,90 x 50	3,921	300	3.600
PACP29060	2,90 x 60	4,590	300	3.600
PACP29070	2,90 x 70	5,267	300	2.400
PACP34030	3,40 x 30	3,135	500	4.000
PACP34040	3,40 x 40	3,553	500	6.000
PACP34050	3,40 x 50	5,137	100	4.500
PACP34060	3,40 x 60	5,818	100	2.400
PACP34070	3,40 x 70	6,625	100	2.400
PACP34080	3,40 x 80	8,123	100	1.600



 Blíster



CÓDIGO	MEDIDA	€/BOLSA	PCS BOLSAS	BOLSAS
BZPACP22520	2,25 x 20	2,582	50	20
BZPACP22525	2,25 x 25	2,582	50	20
BZPACP22530	2,25 x 30	2,582	50	20
BZPACP25040	2,50 x 40	2,582	35	20
BZPACP25050	2,50 x 50	2,582	30	20
BZPACP29060	2,90 x 60	2,582	20	20
BZPACP29070	2,90 x 70	2,582	20	20
BZPACP34040	3,40 x 40	2,582	20	20
BZPACP34050	3,40 x 50	2,582	10	20
BZPACP34060	3,40 x 60	2,582	10	20
BZPACP34070	3,40 x 70	2,582	10	20

MADERA



PA-CC

Puntas acero cabeza cónica cobreada

CÓDIGO	MEDIDA	€/100		
PACC15015	1,5 x 15	0,539	800	36.000
PACC15020	1,5 x 20	0,676	800	36.000
PACC15025	1,5 x 25	0,948	500	22.500
PACC20025	2 x 25	1,294	500	22.500
PACC20030	2 x 30	1,466	500	12.000
PACC20035	2 x 35	1,682	500	12.000
PACC20040	2 x 40	1,888	500	12.000
PACC20045	2 x 45	2,204	500	6.000
PACC20050	2 x 50	2,410	500	6.000



 Blíster

CÓDIGO	MEDIDA	€/BOLSA	PCS BOLSAS	BOLSAS
BZPACC15015	1,5 x 15	2,040	75	20
BZPACC15020	1,5 x 20	2,040	50	20
BZPACC15025	1,5 x 25	2,040	50	20
BZPACC20025	2 x 25	2,040	50	20
BZPACC20030	2 x 30	2,040	50	20
BZPACC20035	2 x 35	2,040	50	20
BZPACC20040	2 x 40	2,040	35	20
BZPACC20045	2 x 45	2,040	35	20
BZPACC20050	2 x 50	2,040	30	20

 Caja ventana

CÓDIGO	MEDIDA	€/CAJA	PCS CAJAS	CAJAS
VPACC15015	1,5 x 15	3,014	240	8
VPACC15020	1,5 x 20	3,144	240	8
VPACC15025	1,5 x 25	3,091	150	8
VPACC20025	2 x 25	3,393	150	8
VPACC20030	2 x 30	3,758	150	8
VPACC20035	2 x 35	3,920	150	8
VPACC20040	2 x 40	4,400	150	8
VPACC20045	2 x 45	5,136	150	8
VPACC20050	2 x 50	5,616	150	8

PC

Puntas clavado

PA-CX

Puntas latón cabeza convexa

MADERA



Blíster

CÓDIGO	MEDIDA	€/BOLSA	PCS	BOLSAS
BZPACX11010	1,1 x 10	2,582	75	20
BZPACX13012	1,3 x 12	2,582	50	20
BZPACX13020	1,3 x 20	2,582	40	20
BZPACX15016	1,5 x 16	2,582	35	20
BZPACX15025	1,5 x 25	2,582	20	20
BZPACX18030	1,8 x 30	2,582	20	20



GM-Z

Grampillón



MADERA



CÓDIGO	MEDIDA	€/100		
GMZ08012	8 x 12	0,523	800	36.000
GMZ10016	10 x 16	0,873	800	19.200
GMZ12020	12 x 20	1,497	800	19.200
GMZ15026	15 x 26	3,360	600	7.200
GMZ17030	17 x 30	5,473	600	7.200
GMZ19035	19 x 35	8,337	400	4.800



Blíster

CÓDIGO	MEDIDA	€/BOLSA	PCS	BOLSAS
BZGMZ08012	8 x 12	2,040	50	20
BZGMZ10016	10 x 16	2,040	40	20
BZGMZ12020	12 x 20	2,040	50	20
BZGMZ15026	15 x 26	2,040	40	20
BZGMZ17030	17 x 30	2,040	25	20
BZGMZ19035	19 x 35	2,040	15	20



Caja ventana

CÓDIGO	MEDIDA	€/CAJA	PCS	CAJAS
VGMZ10016	10 x 16	3,144	240	8
VGMZ15026	15 x 26	8,731	200	8
VGMZ19035	19 x 35	10,837	100	8

CF-B

Colgador cuadro fácil



MULTIMATERIAL



CÓDIGO	MEDIDA	€/100		
CFBL	Blanco	13,413	200	9.000





Blíster

CÓDIGO	MEDIDA	€/BOLSA	PCS	BOLSAS
BZCFBL	Blanco	2,582	10	20

Puntas clavado PC



CÓDIGO	MEDIDA	€/100		
SVNB02	Grande	17,007	200	2.400
SVNB01	Pequeño	12,473	300	3.600



 Blíster

CÓDIGO	MEDIDA	€/BOLSA	PCS 	BOLSAS 
BZSVNB02	Grande	3,377	8	20
BZSVNB01	Pequeño	3,377	10	20

SV-NB

Soporte vitrina blanco



CÓDIGO	MEDIDA	€/100		
SVNM02	Grande	17,007	200	2.400
SVNM01	Pequeño	12,473	300	3.600



 Blíster

CÓDIGO	MEDIDA	€/BOLSA	PCS 	BOLSAS 
BZSVNM02	Grande	3,377	8	20
BZSVNM01	Pequeño	3,377	10	20

SV-NM

Soporte vitrina marrón



CÓDIGO	MEDIDA	€/100		
SVCBL	Blanco	17,007	300	3.600
SVCMA	Marrón	17,007	300	3.600

 Blíster

CÓDIGO	MEDIDA	€/BOLSA	PCS 	BOLSAS 
BZSVCBL	Blanco	3,377	10	20
BZSVCMA	Marrón	3,377	10	20

SV-C

Soporte vitrina cuadrado 2 puntas



MALETINES MULTIREFERENCIA

MALETÍN PROFESIONAL: TIRAFONDOS MADERA + PUNTAS



2.008 pcs.
COD. MLTPPOP101

TP-PO 3 x 20 x300	TP-PO 3 x 25 x250	TP-PO 3,5 x 16 x300	TP-PO 3,5 x 20 x250
TP-PO 3,5 x 25 x200	TP-PO 3,5 x 30 x150	TP-PO 3,5 x 35 x130	TP-PO 4 x 30 x130
TP-PO 4 x 40 x80	TP-PO 4 x 50 x60	TP-PO 5 x 50 x50	TP-PO 5 x 60 x50
TP-PO 5 x 80 x50			PUNTAS x8

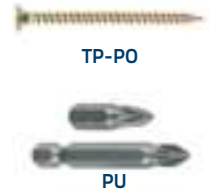

CARACTERÍSTICAS:

- Maletín multiproducto de alta calidad
- Tamaño: 31,2 x 23,8 x 5,1 cms. (Ancho x Fondo x Alto)
- Ergonómico y de fácil manejo
- Apilable
- Configurable hasta 21 cavidades
- Separadores regulables
- Tapa con nervios que evita que se mezclen los tornillos
- Cierre resistente y duradero

CÓDIGO	CONTENIDO	Nº PIEZAS	€/1 pc.
MLTPPOP101	TP-PO+PUNTAS	2.008	71,007

MALETÍN PROFESIONAL MULTIPRODUCTO



670 pcs.
COD. MLTBOP101

TP-PO 5 x 60 x30	TP-PO 5 x 70 x20	TP-PO 5 x 80 x20	DIN-571 6 x 60 x25
TP-PO 4 x 50 x50	TP-PO 5 x 50 x50	TACON Ø 10 x15	DIN-571 6 x 50 x30
TP-PO 3,5 x 25 x60	TP-PO 4 x 30 x70	TP-PO 4 x 40 x70	DIN-571 6 x 40 x30
			TACON Ø 6 x150



CARACTERÍSTICAS:

- Maletín multiproducto de alta calidad
- Tamaño: 31,2 x 23,8 x 5,1 cms. (Ancho x Fondo x Alto)
- Ergonómico y de fácil manejo
- Apilable
- Configurable hasta 21 cavidades
- Separadores regulables
- Tapa con nervios que evita que se mezclen los tornillos
- Cierre resistente y duradero

CÓDIGO	CONTENIDO	Nº PIEZAS	€/1 pc.
MLTBOP101	TP-PO+DIN-571 +TACON	670	60,981

MALETINES MULTIREFERENCIA

MALETÍN TRANSPARENTE

CARACTERÍSTICAS:

- Tres composiciones adaptadas a las necesidades de cada cliente.
- Tres tamaños disponibles para cada composición.
- Permite colgarse en lineal. Dispone de un colgador de alta resistencia.
- Composiciones ideales para aumentar la compra impulsiva en el punto de venta.
- Tapa con nervios que evita que se mezclen los tornillos.

TAMAÑOS



GRANDE
29,5 x 18,5 x 4,5 cms.
(Ancho x Fondo x Alto)



MEDIANO
23,5 x 14,5 x 4 cms.
(Ancho x Fondo x Alto)



PEQUEÑO
16 x 10,5 x 3,5 cms.
(Ancho x Fondo x Alto)

COMPOSICIONES:

MADERA



TP-PO



PU-PO

CÓDIGO	CONTENIDO	TAMAÑO	Nº PIEZAS	€/1 pc.
MLTPPOT101	TP-PO + PUNTAS	PEQUEÑO	407	17,392
MLTPPOT201	TP-PO + PUNTAS	MEDIANO	902	32,291
MLTPPOT301	TP-PO + PUNTAS	GRANDE	1.742	52,105

MULTIPRODUCTO



TACON



AL-RO



AL-HA



AL-HC



TP-PO Z



DIN-571

CÓDIGO	CONTENIDO	TAMAÑO	Nº PIEZAS	€/1 pc.
MLMULT101	MULTIPRODUCTO	PEQUEÑO	165	16,735
MLMULT201	MULTIPRODUCTO	MEDIANO	415	31,072
MLMULT301	MULTIPRODUCTO	GRANDE	1.155	49,244

PLACA DE YESO LAMINADO



AL-HC



AL-RO



AL-HA



TP-PO Z



ANCLA



IN-CO



T4S



TAPLANY



TAPLAME
+ DIN-7981

CÓDIGO	CONTENIDO	TAMAÑO	Nº PIEZAS	€/1 pc.
MLPLAT101	MULTIPRODUCTO	PEQUEÑO	130	16,735
MLPLAT201	MULTIPRODUCTO	MEDIANO	295	31,072
MLPLAT301	MULTIPRODUCTO	GRANDE	455	49,244



CONECTORES PARA MADERA

SO

Soportes perforados

SO-UO

Con orificios de sellado



CÓDIGO	MEDIDA	€/100	Nº AGUJEROS	Ø ORIFICIOS	ESPEJOR	
SOU004110	40 x 110 x 80	555,283	4/1/22	11/7/4,6	2	25
SOU006100	60 x 100 x 80	558,907	4/1/22	11/7/4,6	2	25
SOU007125	70 x 125 x 80	629,833	4/1/28	11/7/4,6	2	25
SOU008120	80 x 120 x 80	632,670	4/1/28	11/7/4,6	2	25
SOU010140	100 x 140 x 80	752,317	4/1/34	11/7/4,6	2	10

SO-UR

De ancho variable con orificios de sellado



CÓDIGO	MEDIDA	€/100	Nº AGUJEROS	Ø ORIFICIOS	ESPEJOR	
SOUR30140DR	26 x 140 x 76	764,594	2/20	11/4,5	2	25
SOUR30140IZ	26 x 140 x 76	764,594	2/20	11/4,5	2	25

SC

Escuadras para unión de madera

SC-EI

De ensamble, perforada con orificios iguales



CÓDIGO	MEDIDA	€/100	Nº AGUJEROS	Ø ORIFICIOS	ESPEJOR	
SCEI040402	40 x 40 x 20	64,502	6	4,5	2	100
SCEI040404	40 x 40 x 40	101,368	8	4,6	2	50
SCEI040406	40 x 40 x 60	174,687	12	4,6	2,5	50
SCEI050504	50 x 50 x 40	117,037	8	4,5	2	50
SCEI060604	60 x 60 x 40	161,943	12	5	2,5	50
SCEI060606	60 x 60 x 60	205,469	18	5	2,5	50
SCEI060608	60 x 60 x 80	381,760	20	4,6	2,5	25
SCEI070704	75 x 75 x 40	236,153	12	4,6	2	50
SCEI080808	80 x 80 x 80	427,600	28	4,6	2,5	25
SCEI101004	100 x 100 x 40	258,327	14	4,6	2	50
SCEI101010	100 x 100 x 100	693,680	46	4,6	2,5	25

SC-ED

De ensamble, perforada con orificios desiguales



CÓDIGO	MEDIDA	€/100	Nº AGUJEROS	Ø ORIFICIOS	ESPEJOR	
SCED050503	50 x 50 x 35	118,902	2/12	11/4,5	2,5	50
SCED060604	60 x 60 x 45	196,113	2/12	10,4/4,8	2,5	50
SCED070705	70 x 70 x 55	263,917	2/20	10,4/4,6	2,5	50
SCED090904	90 x 90 x 40	280,903	4/16	10,4/4,6	3	50
SCED090906	90 x 90 x 65	296,910	5/15	12,8/4,6	2,5	25
SCED101009	105 x 105 x 90	600,507	5/29	13,4/4,6	3	25

SC-LD

De ensamble de lados iguales



CÓDIGO	MEDIDA	€/100	Nº AGUJEROS	Ø ORIFICIOS	ESPEJOR	
SCLD040606	60 x 60 x 40	277,940	2/13	11/5	2,5	50
SCLD060806	60 x 80 x 60	353,073	3/18	11/5	2,5	50

Escuadras para unión de madera

SC



CÓDIGO	MEDIDA	€/100	Nº AGUJEROS	Ø ORIFICIOS	ESPESOR	
SCGA100404	42 x 42 x 100	289,340	16	5	2	25

SC-GA

Grande de ángulo



CÓDIGO	MEDIDA	€/100	Nº AGUJEROS	Ø ORIFICIOS	ESPESOR	
SCRF070705	70 x 70 x 55	271,206	2/12	10,4/4,6	2.5	50
SCRF070605	77 x 64 x 50	244,085	2/10	11/4,6	2	50
SCRF090906	90 x 90 x 65	372,020	2/24	11/4,5	2.5	25
SCRF101009	100 x 100 x 90	612,193	4/26	13,4/4,6	3	25
SCRF151506	150 x 150 x 65	608,147	3/13/1/15	11/5/11x32/5	2.5	25

SC-RF

Reforzada



CÓDIGO	MEDIDA	€/100	Nº AGUJEROS	Ø ORIFICIOS	ESPESOR	
SCRG090505	50 x 90 x 50	271,672	3/15	11/4,6	2.5	50
SCRG090508	50 x 90 x 80	400,897	5/16	13/4,6	2.5	50

SC-RG

Regulable



CÓDIGO	MEDIDA	€/100	Nº AGUJEROS	Ø ORIFICIOS	ESPESOR	
SCAS3317DR	32 x 100 x 170	190,706	20	5	2	50
SCAS3317IZ	32 x 100 x 170	190,706	20	5	2	50

SC-AS

Asimétrica, derecha o izquierda



CÓDIGO	MEDIDA	€/100	Nº AGUJEROS	Ø ORIFICIOS	ESPESOR	
SCCE200404	40 x 200 x 40	299,868	18+1	4,5/11	2	10

SC-CE

Para cemento



SC

Escuadras para unión de madera

SC-OB

Para sillas con orificios biselados en ambas caras



CÓDIGO	MEDIDA	€/100	Nº AGUJEROS	Ø ORIFICIOS	ESPELOR	
SCOB020214	25 x 25 x 15	47,462	4	4	1.8	100
SCOB030314	30 x 30 x 15	54,536	4	4,6	2	100
SCOB040415	40 x 40 x 15	63,666	4	4,5	1.8	100
SCOB050515	50 x 50 x 15	71,583	4	5	2	100
SCOB060618	60 x 60 x 16	78,815	4	5	2	100
SCOB070718	75 x 75 x 18	103,297	4	5,2	2	50
SCOB090920	90 x 90 x 20	146,607	4	6,5	2	50
SCOB101020	100 x 100 x 20	153,849	6	5,5	2	40
SCOB121222	125 x 125 x 22	246,769	6	5,5	2.5	40
SCOB151525	150 x 150 x 25	1.433,861	6	5,5	3	10

SC-CD Z

Grande y de caras desiguales



CÓDIGO	MEDIDA	€/100	Nº AGUJEROS	Ø ORIFICIOS	ESPELOR	
SCCDZ402575	25 x 40 x 75	256,557	5	4,6	2	20

SC-CI

Grande y de caras iguales



CÓDIGO	MEDIDA	€/100	Nº AGUJEROS	Ø ORIFICIOS	ESPELOR	
SCCI303030	30 x 30 x 30	86,156	4	4,6	2	100
SCCI404040	40 x 40 x 40	109,047	4	4,6	2	50
SCCI606060	60 x 60 x 60	236,527	8	4,5	2	50

SC-EM

Para empotrar



CÓDIGO	MEDIDA	€/100	Nº AGUJEROS	Ø ORIFICIOS	ESPELOR	
SCEM081240	80 x 120 x 40	670,384	5	4,7	1.6	20
SCEM101640	100 x 160 x 37	958,649	5	4,5	2	20

SC-ER

Regulable para empotrar



CÓDIGO	MEDIDA	€/100	Nº AGUJEROS	Ø ORIFICIOS	ESPELOR	
SCER302525	25 x 25 x 30	119,470	1/2	4,5 x 14/4,5	1.2	50
SCER392822	39 x 28 x 22	102,390	1/1	4,5 x 16/4,5	1	50

Escuadras para unión de madera

SC



CÓDIGO	MEDIDA	€/100	Nº AGUJEROS	Ø ORIFICIOS	ESPESOR	
SCGEZ704025	25 x 41,5 x 69	247,287	5	4,5	1,5	20

SC-GE Z

Grande y regulable para empotrar



CÓDIGO	MEDIDA	€/KIT	
SCMZ272715	27 x 27 x 15	13,595	12
SCMZ323215	32 x 32 x 15	15,010	12
SCMZ404015	40 x 40 x 15	5,181	10
SCMZ505015	50 x 50 x 15	6,502	10
SCMZ606018	60 x 60 x 18	7,372	12
SCMZ808018	80 x 80 x 18	8,191	10

SC-MZ

Zincada para sillas en maxipack (10 uds)



CÓDIGO	MEDIDA	€/100	Nº AGUJEROS	Ø ORIFICIOS	ESPESOR	
SCPD107530	75 x 100 x 30	273,203	5	5	2,5	50
SCPD128035	80 x 120 x 35	469,013	7	4,5	3,5	25

SC-PD

Para poste, de caras desiguales



CÓDIGO	MEDIDA	€/100	Nº AGUJEROS	Ø ORIFICIOS	ESPESOR	
SCREZ357565	35 x 75 x 65	583,980	3/2/2	7/7 x 25/7 x 60	3	10

SC-RE Z

Regulable



CÓDIGO	MEDIDA	€/100	Nº AGUJEROS	Ø ORIFICIOS	ESPESOR	
SCLCZ354030	34 x 38 x 30	149,033	2	4,5	2	100

SC-LC Z

En L para cercados de celosía con tornillo soldado



PT

Pletinas para unión de madera

PT-BR

De ensamble y brida plana



CÓDIGO	MEDIDA	€/100	N° AGUJEROS	Ø ORIFICIOS	ESPESOR	
PTBR10035	95 x 35	131,447	2/12	11/4,5	2.5	50
PTBR13355	135 x 55	294,177	2/20	11/4,5	2.5	50

PT-EM

Para empotrar



CÓDIGO	MEDIDA	€/100	N° AGUJEROS	Ø ORIFICIOS	ESPESOR	
PTEM18040	180 x 40	432,128	6	4,7	2	20

PT-ET

En "T"



CÓDIGO	MEDIDA	€/100	N° AGUJEROS	Ø ORIFICIOS	ESPESOR	
PTET169845	160 x 98 x 45	1.356,280	4/20	11/4,5	2.5	25

PT-OB

De unión, con orificios biselados en ambas caras



CÓDIGO	MEDIDA	€/100	N° AGUJEROS	Ø ORIFICIOS	ESPESOR	
PTOB05015	50 x 15	55,594	4	4,7	1.75	100
PTOB06015	60 x 15	63,542	4	4,5	1.75	100
PTOB08015	80 x 15	71,484	4	4,5	1.75	100
PTOB10015	100 x 15	83,613	4	5	1.75	100
PTOB12020	120 x 20	91,923	4	5,5	1.75	100

PT-TT

En "T"





CÓDIGO	MEDIDA	€/100	N° AGUJEROS	Ø ORIFICIOS	ESPESOR	
PTTT030716	70 x 35 x 16	167,350	6	4,3	1.5	50
PTTT111430	140 x 80 x 30	418,144	6	5	2	25

PT-UN

De ensamble universal



CÓDIGO	MEDIDA	€/100	N° AGUJEROS	Ø ORIFICIOS	ESPESOR		
PTUN12038	120 x 40	146,380	12	4,6	2	50	-
PTUN16038	160 x 40	210,653	12/1	4,8/11	2	100	400
PTUN20060	200 x 60	311,673	25/1	4,8/11	2	25	-
PTUN20080	200 x 80	361,690	35/1	4,8/11	2	25	75
PTUN24060	240 x 60	433,270	30/1	4,8/11	2	25	-
PTUN24080	240 x 80	533,927	42/1	4,8/11	2	25	50

Anclajes para postes

AP



CÓDIGO	MEDIDA	€/100	Nº AGUJEROS	ESPESOR	
APAR070	70 x 70 x 100 x 100	6.325,812	8	5	1
APAR150	150 x 150 x 100 x 100	8.353,408	8	5	1

AP-AR

Altura regulable



CÓDIGO	MEDIDA	€/100	Nº AGUJEROS	Ø ORIFICIOS	ESPESOR	
APAT071	71 x 200 x 60 x 50	2.680,650	6	10,5	4	1
APAT091	91 x 200 x 60 x 50	2.878,520	6	10,5	4	1
APAT101	101 x 200 x 60 x 50	2.977,833	6	10,5	4	1

AP-AT

En "U" para atornillar directamente o sobre espárragos



CÓDIGO	MEDIDA	€/100	Nº AGUJEROS	Ø ORIFICIOS	ESPESOR	
APFL801020	80 x 100 x 200 x 60	2.140,663	3	11	4	1

AP-FL

En "L", soldado y con pata de acero corrugado



CÓDIGO	MEDIDA	€/100	Nº AGUJEROS	Ø ORIFICIOS	ESPESOR	
APFUZ100	60-140 x 115 x 100 x 70	5.032,443	3/4	11/7	4,5	1

AP-FU Z

En "U" con ancho regulable



CÓDIGO	MEDIDA	€/100	Nº AGUJEROS	Ø ORIFICIOS	ESPESOR	
APPD100	100 x 100 x 150 x 42	7.658,307	8	10,5	5	1

AP-PD

Desigual

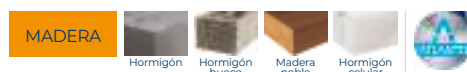

CÓDIGO	MEDIDA	€/100	Nº AGUJEROS	Ø ORIFICIOS	ESPESOR	
APPG070	70 x 90 x 70 x 80 x 90	6.281,427	8	8,5	5	1
APPG100	100 x 100 x 100 x 100 x 100	7.495,563	8	10,5	5	1

AP-PG

Igual



AP Anclajes para postes

AP-PT

En "U" soldado con pata de acero corrugada

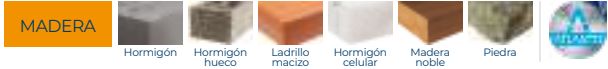

CÓDIGO	MEDIDA	€/100	Nº AGUJEROS	Ø ORIFICIOS	ESPESOR	
APPT071	71 x 100 x 200 x 60	2.488,343	6	10,5	4	1
APPT091	91 x 100 x 200 x 60	2.607,983	6	10,5	4	1
APPT101	101 x 100 x 200 x 60	2.663,733	6	10,5	4	1

AP-UE Z

En "U" para empotrar con ancho regulable



CÓDIGO	MEDIDA	€/100	Nº AGUJEROS	Ø ORIFICIOS	ESPESOR	
APUEZ200	71-131 x 110 x 200 x 70	5.064,420	6	11-7	4,5	1

AP-SB

Sobre base



CÓDIGO	MEDIDA	€/100	Nº AGUJEROS	Ø ORIFICIOS	ESPESOR	UD. MIN. VENTA	
APSB71	71 x 71 x 150	1.894,930	2	4 x 11	1,8	2	1
APSB91	91 x 91 x 150	2.380,617	2	4 x 11	1,8	2	1

AP-EN

Para enterrar



CÓDIGO	MEDIDA	€/100	Nº AGUJEROS	Ø ORIFICIOS	ESPESOR	UD. MIN. VENTA	
APEN71	71 x 71 x 750	3.402,208	2	4 x 11	1,8	2	1
APEN91	91 x 91 x 750	3.582,855	2	4 x 11	1,8	2	1

VM-PF Puntas de fijación ATLANTIS C3-M



CÓDIGO	MEDIDA	€/100	PCS. X BOTE	
VMPF050	4 x 50	28,563	1	200



TORNILLERÍA NORMALIZADA



DIN-933

Tornillo rosca métrica con cabeza hexagonal 8.8. Rosca completa

DIN-933

Zincado

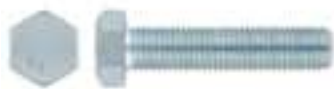

Disponible en varios recubrimientos. Consulte precio y plazo de entrega.

METAL



CÓDIGO	MEDIDA	€/100				CÓDIGO	MEDIDA	€/100			
D93304008	M4 x 8	4,244	7	500	22.500	D93310100	M10 x 100	90,630	17	50	300
D93304010	M4 x 10	4,426	7	500	22.500	D93312020	M12 x 20	45,797	19	100	1.200
D93304012	M4 x 12	4,932	7	500	12.000	D93312025	M12 x 25	47,871	19	100	600
D93304016	M4 x 16	5,037	7	500	12.000	D93312030	M12 x 30	52,424	19	100	600
D93304020	M4 x 20	6,101	7	500	12.000	D93312035	M12 x 35	60,911	19	100	600
D93304025	M4 x 25	6,525	7	500	6.000	D93312040	M12 x 40	62,450	19	100	600
D93304030	M4 x 30	7,167	7	500	6.000	D93312045	M12 x 45	65,961	19	100	600
D93304035	M4 x 35	7,840	7	250	6.000	D93312050	M12 x 50	69,567	19	100	400
D93304040	M4 x 40	10,346	7	250	3.000	D93312060	M12 x 60	78,166	19	100	400
D93304045	M4 x 45	10,800	7	250	3.000	D93312070	M12 x 70	98,937	19	100	400
D93304050	M4 x 50	12,922	7	250	3.000	D93312080	M12 x 80	102,347	19	50	300
D93304060	M4 x 60	17,250	7	250	3.000	D93312090	M12 x 90	115,107	19	50	300
D93305010	M5 x 10	5,488	8	500	12.000	D93312100	M12 x 100	125,647	19	25	300
D93305012	M5 x 12	5,793	8	500	12.000	D93312110	M12 x 110	156,411	19	25	300
D93305016	M5 x 16	6,430	8	500	6.000	D93312120	M12 x 120	162,761	19	25	300
D93305020	M5 x 20	6,697	8	500	6.000	D93314030	M14 x 30	89,319	22	50	400
D93305025	M5 x 25	7,636	8	500	6.000	D93314035	M14 x 35	96,986	22	50	300
D93305030	M5 x 30	9,194	8	500	6.000	D93314040	M14 x 40	101,538	22	50	300
D93305035	M5 x 35	9,336	8	250	3.000	D93314045	M14 x 45	105,098	22	50	300
D93305040	M5 x 40	10,074	8	250	3.000	D93314050	M14 x 50	108,964	22	50	300
D93305045	M5 x 45	11,515	8	250	3.000	D93314060	M14 x 60	119,728	22	50	300
D93305050	M5 x 50	12,508	8	250	3.000	D93314070	M14 x 70	150,654	22	50	300
D93305060	M5 x 60	16,546	8	250	1.500	D93314080	M14 x 80	154,893	22	25	150
D93305070	M5 x 70	23,900	8	250	3.000	D93314090	M14 x 90	172,788	22	25	150
D93306010	M6 x 10	6,965	10	250	6.000	D93314100	M14 x 100	174,993	22	25	150
D93306012	M6 x 12	7,017	10	250	6.000	D93314110	M14 x 110	198,723	22	25	150
D93306016	M6 x 16	7,530	10	250	6.000	D93314120	M14 x 120	218,002	22	25	150
D93306020	M6 x 20	8,123	10	250	3.000	D93316030	M16 x 30	114,767	24	50	300
D93306025	M6 x 25	9,707	10	250	3.000	D93316035	M16 x 35	117,177	24	50	300
D93306030	M6 x 30	11,279	10	250	3.000	D93316040	M16 x 40	120,810	24	50	300
D93306035	M6 x 35	12,727	10	250	3.000	D93316045	M16 x 45	131,039	24	50	300
D93306040	M6 x 40	13,766	10	250	3.000	D93316050	M16 x 50	139,164	24	50	300
D93306045	M6 x 45	15,970	10	250	1.500	D93316060	M16 x 60	151,994	24	50	200
D93306050	M6 x 50	16,549	10	250	1.500	D93316070	M16 x 70	192,225	24	25	150
D93306060	M6 x 60	19,353	10	100	1.200	D93316080	M16 x 80	198,270	24	25	150
D93306065	M6 x 65	22,090	10	100	600	D93316090	M16 x 90	210,891	24	25	150
D93306070	M6 x 70	22,420	10	100	1.200	D93316100	M16 x 100	228,438	24	25	150
D93308016	M8 x 16	15,355	13	200	2.400	D93316110	M16 x 110	252,563	24	25	150
D93308020	M8 x 20	18,361	13	200	1.600	D93316120	M16 x 120	311,800	24	25	150
D93308025	M8 x 25	19,969	13	200	1.600	D93318030	M18 x 30	164,458	27	25	150
D93308030	M8 x 30	20,455	13	200	1.200	D93318035	M18 x 35	180,951	27	25	300
D93308035	M8 x 35	24,340	13	200	1.200	D93318040	M18 x 40	203,988	27	25	300
D93308040	M8 x 40	26,831	13	200	1.200	D93318045	M18 x 45	207,395	27	25	300
D93308045	M8 x 45	29,736	13	200	1.200	D93318050	M18 x 50	215,726	27	25	150
D93308050	M8 x 50	32,700	13	200	800	D93318060	M18 x 60	246,009	27	25	150
D93308060	M8 x 60	36,453	13	200	800	D93318070	M18 x 70	272,724	27	25	150
D93308070	M8 x 70	39,082	13	200	800	D93318080	M18 x 80	332,622	27	25	150
D93308080	M8 x 80	44,849	13	100	600	D93318090	M18 x 90	350,835	27	25	150
D93308090	M8 x 90	50,765	13	100	600	D93318100	M18 x 100	354,459	27	25	150
D93308100	M8 x 100	55,814	13	100	400	D93318110	M18 x 110	389,649	27	25	100
D93308110	M8 x 110	72,825	13	100	400	D93318120	M18 x 120	480,570	27	25	100
D93308120	M8 x 120	73,279	13	100	400	D93320030	M20 x 30	226,453	30	25	150
D93310016	M10 x 16	28,567	17	200	1.200	D93320035	M20 x 35	246,067	30	25	150
D93310020	M10 x 20	29,829	17	200	1.200	D93320040	M20 x 40	247,167	30	25	150
D93310025	M10 x 25	34,561	17	200	1.200	D93320045	M20 x 45	256,507	30	25	150
D93310030	M10 x 30	36,392	17	200	800	D93320050	M20 x 50	289,613	30	25	150
D93310035	M10 x 35	43,363	17	200	1.200	D93320060	M20 x 60	333,544	30	25	150
D93310040	M10 x 40	43,857	17	200	800	D93320070	M20 x 70	341,785	30	25	100
D93310045	M10 x 45	48,226	17	200	800	D93320080	M20 x 80	375,047	30	10	120
D93310050	M10 x 50	48,726	17	200	800	D93320090	M20 x 90	406,602	30	10	60
D93310060	M10 x 60	64,997	17	100	600	D93320100	M20 x 100	443,723	30	10	60
D93310070	M10 x 70	66,180	17	100	400	D93320110	M20 x 110	579,802	30	10	60
D93310080	M10 x 80	77,110	17	100	400	D93320120	M20 x 120	605,115	30	10	60
D93310090	M10 x 90	85,298	17	50	300						



Tornillo rosca métrica con cabeza hexagonal 8.8. Rosca completa

DIN-933

DIN-933

Zincado



Blíster

CÓDIGO	MEDIDA	€/BOLSA	PCS	BOLSAS
BZ3Z04008	M4 x 8	2,040	6	20
BZ3Z04010	M4 x 10	2,040	6	20
BZ3Z04012	M4 x 12	2,040	6	20
BZ3Z04016	M4 x 16	2,040	6	20
BZ3Z04020	M4 x 20	2,040	6	20
BZ3Z04025	M4 x 25	2,040	6	20
BZ3Z04030	M4 x 30	2,040	6	20
BZ3Z04035	M4 x 35	2,040	6	20
BZ3Z04040	M4 x 40	2,040	6	20
BZ3Z04045	M4 x 45	2,040	6	20
BZ3Z04050	M4 x 50	2,040	6	20
BZ3Z04060	M4 x 60	2,040	6	20
BZ3Z05010	M5 x 10	2,040	6	20
BZ3Z05012	M5 x 12	2,040	6	20
BZ3Z05015	M5 x 15	2,040	6	20
BZ3Z05016	M5 x 16	2,040	6	20
BZ3Z05020	M5 x 20	2,040	6	20
BZ3Z05025	M5 x 25	2,040	6	20
BZ3Z05030	M5 x 30	2,040	6	20
BZ3Z05035	M5 x 35	2,040	6	20
BZ3Z05040	M5 x 40	2,040	6	20
BZ3Z05045	M5 x 45	2,040	6	20
BZ3Z05050	M5 x 50	2,040	6	20
BZ3Z05060	M5 x 60	2,040	6	20
BZ3Z06016	M6 x 16	2,040	6	20
BZ3Z06020	M6 x 20	2,040	6	20
BZ3Z06025	M6 x 25	2,040	6	20
BZ3Z06030	M6 x 30	2,040	6	20
BZ3Z06040	M6 x 40	2,040	6	20
BZ3Z06050	M6 x 50	2,040	6	20
BZ3Z06060	M6 x 60	2,040	4	20
BZ3Z06070	M6 x 70	2,040	4	20
BZ3Z08016	M8 x 16	2,040	4	20
BZ3Z08020	M8 x 20	2,040	4	20
BZ3Z08025	M8 x 25	2,040	4	20
BZ3Z08030	M8 x 30	2,040	4	20
BZ3Z08040	M8 x 40	2,040	4	20
BZ3Z08050	M8 x 50	2,040	4	20
BZ3Z08060	M8 x 60	2,040	4	20
BZ3Z08070	M8 x 70	2,040	4	20
BZ3Z08080	M8 x 80	2,040	4	20
BZ3Z10030	M10 x 30	2,040	2	20
BZ3Z10040	M10 x 40	2,040	2	20
BZ3Z10050	M10 x 50	2,040	2	20



Caja ventana

CÓDIGO	MEDIDA	€/CAJA	PCS	CAJAS
VD93304008	M4 x 8	5,276	100	8
VD93304010	M4 x 10	5,395	100	8
VD93304012	M4 x 12	5,673	100	8
VD93304016	M4 x 16	6,053	100	8
VD93304020	M4 x 20	6,972	100	8
VD93304025	M4 x 25	6,480	80	8
VD93304030	M4 x 30	7,091	80	8
VD93304040	M4 x 40	5,879	50	8
VD93304050	M4 x 50	5,941	40	8
VD93304060	M4 x 60	8,793	40	8
VD93305010	M5 x 10	6,325	100	8
VD93305012	M5 x 12	5,344	80	8
VD93305016	M5 x 16	6,028	80	8
VD93305020	M5 x 20	5,881	70	8
VD93305025	M5 x 25	5,741	60	8
VD93305030	M5 x 30	4,600	40	8
VD93305040	M5 x 40	4,552	30	8
VD93305050	M5 x 50	3,635	15	8
VD93305060	M5 x 60	4,066	15	8
VD93305070	M5 x 70	3,822	10	8
VD93306016	M6 x 16	5,379	50	8
VD93306020	M6 x 20	5,627	50	8
VD93306025	M6 x 25	5,225	45	8
VD93306030	M6 x 30	5,341	40	8
VD93306040	M6 x 40	5,196	30	8
VD93306050	M6 x 50	4,323	15	8
VD93306060	M6 x 60	4,213	15	8
VD93306070	M6 x 70	4,948	15	8
VD93308016	M8 x 16	7,888	40	8
VD93308020	M8 x 20	7,443	35	8
VD93308025	M8 x 25	7,204	30	8
VD93308030	M8 x 30	6,734	25	8
VD93308040	M8 x 40	5,999	20	8
VD93308050	M8 x 50	5,404	15	8
VD93308060	M8 x 60	6,301	15	8
VD93308070	M8 x 70	7,847	15	8
VD93308080	M8 x 80	6,580	10	8
VD93308100	M8 x 100	8,763	10	8
VD93310020	M10 x 20	6,021	15	8
VD93310030	M10 x 30	7,057	15	8
VD93310040	M10 x 40	5,687	10	8
VD93310050	M10 x 50	6,451	10	8
VD93310060	M10 x 60	7,789	10	8
VD93310070	M10 x 70	8,141	10	8
VD93310080	M10 x 80	9,208	10	8
VD93312030	M12 x 30	6,744	10	8
VD93312040	M12 x 40	6,731	8	8
VD93312050	M12 x 50	5,721	6	8
VD93312060	M12 x 60	6,345	6	8
VD93312070	M12 x 70	7,249	6	8
VD93312080	M12 x 80	8,396	6	8

DIN-933

Tornillo rosca métrica con cabeza hexagonal 8.8. Rosca completa

DIN-933 A2

INOXIDABLE



Inoxidable A2



CÓDIGO	MEDIDA	€/100				CÓDIGO	MEDIDA	€/100			
D933IM04010	M4 x 10	9,093	7	500	12.000	D933IM10040	M10 x 40	94,335	17	200	-
D933IM04016	M4 x 16	10,890	7	500	12.000	D933IM10050	M10 x 50	103,379	17	200	-
D933IM04020	M4 x 20	12,527	7	500	8.000	D933IM10060	M10 x 60	118,386	17	100	600
D933IM04025	M4 x 25	13,517	7	500	8.000	D933IM10070	M10 x 70	133,539	17	100	400
D933IM04030	M4 x 30	18,118	7	500	6.000	D933IM10080	M10 x 80	157,127	17	100	400
D933IM04035	M4 x 35	19,000	7	250	6.000	D933IM10090	M10 x 90	171,313	17	50	300
D933IM04040	M4 x 40	21,123	7	250	6.000	D933IM10100	M10 x 100	193,297	17	50	300
D933IM05010	M5 x 10	9,497	8	500	8.000	D933IM12020	M12 x 20	106,508	19	100	600
D933IM05016	M5 x 16	11,137	8	500	-	D933IM12030	M12 x 30	110,786	19	100	600
D933IM05020	M5 x 20	12,613	8	500	6.000	D933IM12040	M12 x 40	128,797	19	100	400
D933IM05025	M5 x 25	14,953	8	500	4.000	D933IM12050	M12 x 50	148,635	19	100	400
D933IM05030	M5 x 30	17,893	8	500	4.000	D933IM12060	M12 x 60	169,412	19	100	400
D933IM05035	M5 x 35	19,211	8	250	3.000	D933IM12070	M12 x 70	190,406	19	100	-
D933IM05040	M5 x 40	21,579	8	250	3.000	D933IM12080	M12 x 80	225,610	19	50	300
D933IM05050	M5 x 50	25,553	8	250	3.000	D933IM12090	M12 x 90	247,007	19	50	300
D933IM06010	M6 x 10	15,933	10	250	6.000	D933IM12100	M12 x 100	268,407	19	25	150
D933IM06016	M6 x 16	16,880	10	250	4.000	D933IM14030	M14 x 30	204,223	22	50	300
D933IM06020	M6 x 20	19,557	10	250	4.000	D933IM14040	M14 x 40	253,490	22	50	300
D933IM06025	M6 x 25	20,323	10	250	3.000	D933IM14050	M14 x 50	277,438	22	50	300
D933IM06030	M6 x 30	23,610	10	250	3.000	D933IM14060	M14 x 60	328,437	22	50	200
D933IM06035	M6 x 35	26,700	10	250	2.000	D933IM14070	M14 x 70	330,035	22	50	200
D933IM06040	M6 x 40	32,790	10	250	2.000	D933IM14080	M14 x 80	354,507	22	25	150
D933IM06050	M6 x 50	36,968	10	250	1.500	D933IM14100	M14 x 100	539,080	22	25	150
D933IM08016	M8 x 16	34,613	13	200	1.600	D933IM16030	M16 x 30	265,604	24	50	300
D933IM08020	M8 x 20	35,644	13	200	1.600	D933IM16040	M16 x 40	271,385	24	50	200
D933IM08025	M8 x 25	38,117	13	200	1.600	D933IM16050	M16 x 50	312,188	24	50	200
D933IM08030	M8 x 30	42,380	13	200	1.200	D933IM16060	M16 x 60	320,347	24	50	200
D933IM08035	M8 x 35	46,633	13	200	1.200	D933IM16070	M16 x 70	357,073	24	25	150
D933IM08040	M8 x 40	58,337	13	200	1.200	D933IM16080	M16 x 80	453,421	24	25	150
D933IM08050	M8 x 50	61,937	13	200	800	D933IM16090	M16 x 90	502,047	24	25	150
D933IM08060	M8 x 60	70,693	13	200	800	D933IM16100	M16 x 100	543,837	24	25	100
D933IM08070	M8 x 70	96,006	13	200	800	D933IM18030	M18 x 30	450,847	27	25	100
D933IM08080	M8 x 80	96,820	13	100	600	D933IM18040	M18 x 40	476,837	27	25	200
D933IM08090	M8 x 90	107,270	13	100	600	D933IM18050	M18 x 50	520,883	27	25	150
D933IM08100	M8 x 100	120,357	13	100	600	D933IM18060	M18 x 60	582,160	27	25	150
D933IM10020	M10 x 20	63,470	17	200	800	D933IM18070	M18 x 70	647,253	27	25	100
D933IM10025	M10 x 25	75,439	17	200	800	D933IM18080	M18 x 80	708,547	27	25	100
D933IM10030	M10 x 30	76,921	17	200	800	D933IM18090	M18 x 90	769,830	27	25	100
D933IM10035	M10 x 35	92,976	17	200	800	D933IM18100	M18 x 100	831,110	27	25	100

Blíster

CÓDIGO	MEDIDA	€/BOLSA	PCS	BOLSAS
BZ3I04010	M4 x 10	2,582	6	20
BZ3I04016	M4 x 16	2,582	6	20
BZ3I04020	M4 x 20	2,582	6	20
BZ3I04030	M4 x 30	2,582	6	20
BZ3I04040	M4 x 40	2,582	6	20
BZ3I05010	M5 x 10	2,582	6	20
BZ3I05016	M5 x 16	2,582	6	20
BZ3I05020	M5 x 20	2,582	6	20
BZ3I05030	M5 x 30	2,582	6	20
BZ3I05040	M5 x 40	2,582	6	20
BZ3I05050	M5 x 50	2,582	6	20
BZ3I06016	M6 x 16	2,582	6	20
BZ3I06020	M6 x 20	2,582	6	20
BZ3I06025	M6 x 25	2,582	6	20
BZ3I06030	M6 x 30	2,582	6	20
BZ3I06040	M6 x 40	2,582	6	20
BZ3I06050	M6 x 50	2,582	6	20
BZ3I08016	M8 x 16	2,582	4	20
BZ3I08020	M8 x 20	2,582	4	20
BZ3I08025	M8 x 25	2,582	4	20
BZ3I08030	M8 x 30	2,582	4	20
BZ3I08040	M8 x 40	2,582	4	20
BZ3I08050	M8 x 50	2,582	4	20
BZ3I08060	M8 x 60	2,582	4	20
BZ3I10020	M10 x 20	2,582	2	20
BZ3I10030	M10 x 30	2,582	2	20
BZ3I10040	M10 x 40	2,582	2	20

Caja ventana

CÓDIGO	MEDIDA	€/CAJA	PCS	CAJAS
VD933I04010	M4 x 10	5,047	40	8
VD933I04016	M4 x 16	6,045	40	8
VD933I04020	M4 x 20	6,702	40	8
VD933I04030	M4 x 30	6,986	30	8
VD933I04040	M4 x 40	7,061	25	8
VD933I05010	M5 x 10	5,273	40	8
VD933I05016	M5 x 16	6,184	40	8
VD933I05020	M5 x 20	7,001	40	8
VD933I05030	M5 x 30	4,905	20	8
VD933I05040	M5 x 40	5,796	20	8
VD933I05050	M5 x 50	3,919	10	8
VD933I06010	M6 x 10	6,638	30	8
VD933I06016	M6 x 16	6,767	30	8
VD933I06020	M6 x 20	7,842	30	8
VD933I06025	M6 x 25	6,789	25	8
VD933I06030	M6 x 30	8,306	25	8
VD933I06040	M6 x 40	6,470	15	8
VD933I06050	M6 x 50	5,115	10	8
VD933I08016	M8 x 16	9,105	20	8
VD933I08020	M8 x 20	9,372	20	8
VD933I08025	M8 x 25	10,582	20	8
VD933I08030	M8 x 30	8,826	15	8
VD933I08040	M8 x 40	7,520	10	8
VD933I08050	M8 x 50	8,595	10	8
VD933I08060	M8 x 60	9,812	10	8
VD933I10020	M10 x 20	8,809	10	8
VD933I10030	M10 x 30	10,124	10	8
VD933I10040	M10 x 40	11,657	10	8
VD933I10050	M10 x 50	13,884	10	8
VD933I10060	M10 x 60	16,394	10	8



Tornillo rosca métrica con cabeza hexagonal 8.8. Rosca media

DIN-931

METAL



Disponible en varios recubrimientos. Consulte precio y plazo de entrega.

CÓDIGO	MEDIDA	€/100			
D931806030	M6 x 30	10,376	10	250	3.000
D931806035	M6 x 35	11,709	10	250	2.000
D931806040	M6 x 40	13,490	10	250	2.000
D931806045	M6 x 45	14,692	10	250	2.000
D931806050	M6 x 50	15,225	10	250	1.500
D931806060	M6 x 60	17,805	10	100	1.200
D931806070	M6 x 70	20,178	10	100	1.200
D931808030	M8 x 30	20,455	13	200	1.200
D931808035	M8 x 35	23,853	13	200	1.200
D931808040	M8 x 40	26,294	13	200	1.200
D931808045	M8 x 45	28,249	13	200	1.200
D931808050	M8 x 50	31,065	13	250	1.000
D931808060	M8 x 60	35,724	13	250	-
D931808070	M8 x 70	38,300	13	250	-
D931808080	M8 x 80	43,952	13	100	600
D931808090	M8 x 90	48,227	13	100	600
D931808100	M8 x 100	51,349	13	100	600
D931808110	M8 x 110	65,543	13	100	400
D931808120	M8 x 120	71,080	13	100	400
D931808130	M8 x 130	92,500	13	50	400
D931808140	M8 x 140	108,871	13	50	400
D931808150	M8 x 150	109,118	13	50	400
D931810035	M10 x 35	39,894	17	200	800
D931810040	M10 x 40	40,348	17	200	-
D931810045	M10 x 45	44,368	17	200	-
D931810050	M10 x 50	44,828	17	200	-
D931810060	M10 x 60	64,997	17	100	600
D931810070	M10 x 70	66,180	17	100	400
D931810080	M10 x 80	75,568	17	100	400
D931810090	M10 x 90	85,298	17	50	300
D931810100	M10 x 100	90,630	17	50	300
D931810110	M10 x 110	113,978	17	50	300
D931810120	M10 x 120	130,687	17	50	300
D931810130	M10 x 130	137,183	17	50	200
D931810140	M10 x 140	147,553	17	50	200
D931810150	M10 x 150	149,499	17	25	200
D931812040	M12 x 40	61,201	19	100	400
D931812045	M12 x 45	65,961	19	100	400
D931812050	M12 x 50	68,176	19	100	400
D931812060	M12 x 60	76,603	19	100	400
D931812070	M12 x 70	96,958	19	100	400
D931812080	M12 x 80	102,347	19	50	300
D931812090	M12 x 90	112,805	19	50	200
D931812100	M12 x 100	125,647	19	25	200
D931812110	M12 x 110	156,411	19	25	200
D931812120	M12 x 120	159,506	19	25	200

CÓDIGO	MEDIDA	€/100			
D931812130	M12 x 130	180,846	19	25	200
D931812140	M12 x 140	195,548	19	25	-
D931812150	M12 x 150	199,023	19	10	120
D931814050	M14 x 50	103,516	22	50	300
D931814060	M14 x 60	119,728	22	50	200
D931814070	M14 x 70	138,602	22	50	200
D931814080	M14 x 80	151,795	22	25	150
D931814090	M14 x 90	172,788	22	25	150
D931814100	M14 x 100	174,993	22	25	150
D931814110	M14 x 110	198,723	22	25	150
D931814120	M14 x 120	218,002	22	25	150
D931814130	M14 x 130	258,278	22	25	100
D931814140	M14 x 140	272,900	22	25	100
D931814150	M14 x 150	322,613	22	10	120
D931816050	M16 x 50	128,031	24	50	200
D931816060	M16 x 60	151,994	24	50	200
D931816070	M16 x 70	188,381	24	25	150
D931816080	M16 x 80	198,270	24	25	150
D931816090	M16 x 90	210,891	24	25	150
D931816100	M16 x 100	228,438	24	25	100
D931816110	M16 x 110	252,563	24	25	100
D931816120	M16 x 120	305,564	24	25	100
D931816130	M16 x 130	307,853	24	25	100
D931816140	M16 x 140	323,777	24	25	100
D931816150	M16 x 150	371,788	24	10	80
D931818060	M18 x 60	246,009	27	25	150
D931818070	M18 x 70	267,270	27	25	100
D931818080	M18 x 80	306,012	27	25	100
D931818090	M18 x 90	333,293	27	25	100
D931818100	M18 x 100	336,736	27	25	100
D931818110	M18 x 110	370,166	27	10	80
D931818120	M18 x 120	442,125	27	10	80
D931818130	M18 x 130	524,581	27	10	80
D931818140	M18 x 140	558,544	27	10	80
D931818150	M18 x 150	633,365	27	10	-
D931820060	M20 x 60	316,866	30	25	100
D931820070	M20 x 70	324,695	30	25	100
D931820080	M20 x 80	356,295	30	25	100
D931820090	M20 x 90	374,074	30	25	100
D931820100	M20 x 100	443,723	30	25	-
D931820110	M20 x 110	568,206	30	10	-
D931820120	M20 x 120	605,115	30	10	-
D931820130	M20 x 130	670,096	30	10	-
D931820140	M20 x 140	706,307	30	10	60
D931820150	M20 x 150	801,883	30	5	30



Caja ventana

CÓDIGO	MEDIDA	€/CAJA	PCS	CAJAS
VD93106030	M6 x 30	5,947	40	8
VD93106040	M6 x 40	5,841	30	8
VD93106050	M6 x 50	3,870	15	8
VD93106060	M6 x 60	4,328	15	8
VD93106070	M6 x 70	5,000	15	8
VD93108030	M8 x 30	7,344	25	8
VD93108040	M8 x 40	6,384	20	8
VD93108050	M8 x 50	5,612	15	8
VD93108060	M8 x 60	6,752	15	8
VD93108070	M8 x 70	8,106	15	8
VD93108080	M8 x 80	7,121	10	8
VD93110040	M10 x 40	5,723	10	8
VD93110050	M10 x 50	7,093	10	8
VD93110060	M10 x 60	7,219	10	8
VD93110070	M10 x 70	8,464	10	8
VD93110080	M10 x 80	9,979	10	8
VD93112050	M12 x 50	6,092	6	8
VD93112060	M12 x 60	6,580	6	8
VD93112070	M12 x 70	7,405	6	8
VD93112080	M12 x 80	8,715	6	8

DIN-6921

Tornillo cabeza hexagonal con arandela estampada y grafilada 8.8

DIN-6921

METAL



Zincado



Disponible en varios recubrimientos. Consulte precio y plazo de entrega.

CÓDIGO	MEDIDA	€/100			
D692105010	M5 x 10	10,528	8	500	6.000
D692105012	M5 x 12	10,609	8	500	4.000
D692105016	M5 x 16	10,967	8	500	4.000
D692105020	M5 x 20	11,252	8	500	3.000
D692105025	M5 x 25	13,207	8	500	3.000
D692105030	M5 x 30	16,470	8	500	3.000
D692106010	M6 x 10	14,960	10	250	-
D692106012	M6 x 12	14,950	10	250	3.000
D692106016	M6 x 16	15,140	10	250	3.000
D692106020	M6 x 20	16,083	10	250	3.000
D692106025	M6 x 25	17,980	10	250	2.000
D692106030	M6 x 30	20,867	10	250	2.000
D692106035	M6 x 35	21,754	10	250	1.500
D692108012	M8 x 12	25,833	13	200	1.600
D692108016	M8 x 16	26,857	13	200	1.600
D692108020	M8 x 20	30,321	13	200	-
D692108025	M8 x 25	34,348	13	200	-
D692108030	M8 x 30	39,253	13	200	1.200
D692108035	M8 x 35	44,201	13	200	1.200
D692108040	M8 x 40	46,288	13	200	800
D692108050	M8 x 50	47,197	13	200	800
D692108060	M8 x 60	54,849	13	200	600
D692110020	M10 x 20	51,918	15	200	800
D692110025	M10 x 25	53,858	15	200	800
D692110030	M10 x 30	57,410	15	200	800
D692110035	M10 x 35	61,183	15	200	-
D692110040	M10 x 40	75,667	15	200	-
D692110050	M10 x 50	87,043	15	200	-
D692112025	M12 x 25	86,990	16	100	400
D692112030	M12 x 30	88,863	16	100	400
D692112035	M12 x 35	99,993	16	100	400
D692112040	M12 x 40	98,327	16	100	400
D692112045	M12 x 45	110,817	16	100	400
D692112050	M12 x 50	114,227	16	100	-
D692112060	M12 x 60	130,120	16	100	-

DIN-6921 A2

METAL



Tornillo DIN-6921. Tornillo hexagonal con arandela estampada y grafilada. Inoxidable A2



CÓDIGO	MEDIDA	€/100	LLAVE DE INSTALACIÓN			
692108020	M8 x 20	50,523	13	200	2.400	2.400
692108050	M8 x 50	80,817	13	100	600	600
692108070	M8 x 70	117,303	13	100	600	600



Tornillo rosca métrica con cabeza Allen 8.8

DIN-912

METAL



CÓDIGO	MEDIDA	€/100			
D91204008	M4 x 8	6,042	3	500	22.500
D91204010	M4 x 10	6,761	3	500	12.000
D91204012	M4 x 12	7,673	3	500	12.000
D91204016	M4 x 16	7,940	3	500	12.000
D91204020	M4 x 20	8,954	3	500	6.000
D91204025	M4 x 25	10,072	3	500	6.000
D91204030	M4 x 30	10,737	3	500	6.000
D91204035	M4 x 35	11,347	3	200	4.800
D91204040	M4 x 40	12,067	3	200	2.400
D91204045	M4 x 45	15,620	3	200	2.400
D91204050	M4 x 50	16,310	3	200	2.400
D91205008	M5 x 8	8,137	4	500	12.000
D91205010	M5 x 10	7,533	4	500	12.000
D91205012	M5 x 12	7,567	4	500	6.000
D91205016	M5 x 16	7,945	4	500	6.000
D91205020	M5 x 20	8,055	4	500	6.000
D91205025	M5 x 25	9,102	4	500	6.000
D91205030	M5 x 30	10,387	4	500	6.000
D91205035	M5 x 35	13,567	4	200	4.800
D91205040	M5 x 40	13,950	4	200	2.400
D91205045	M5 x 45	14,340	4	200	2.400
D91205050	M5 x 50	15,193	4	200	2.400
D91206010	M6 x 10	8,662	5	200	4.800
D91206012	M6 x 12	10,897	5	200	4.800
D91206016	M6 x 16	11,040	5	200	4.800
D91206020	M6 x 20	11,417	5	200	2.400
D91206025	M6 x 25	13,116	5	200	2.400
D91206030	M6 x 30	14,503	5	200	2.400
D91206035	M6 x 35	16,120	5	200	2.400
D91206040	M6 x 40	18,177	5	200	2.400
D91206045	M6 x 45	22,610	5	200	2.400
D91206050	M6 x 50	22,859	5	200	2.400
D91206060	M6 x 60	24,343	5	200	1.200
D91208010	M8 x 10	16,523	6	100	2.400
D91208012	M8 x 12	18,663	6	100	2.400
D91208016	M8 x 16	20,531	6	100	2.400
D91208020	M8 x 20	20,916	6	100	2.400

CÓDIGO	MEDIDA	€/100			
D91208025	M8 x 25	22,427	6	100	1.200
D91208030	M8 x 30	28,245	6	100	1.200
D91208035	M8 x 35	29,257	6	100	1.200
D91208040	M8 x 40	34,667	6	100	1.200
D91208045	M8 x 45	35,369	6	100	1.200
D91208050	M8 x 50	37,049	6	100	1.200
D91208060	M8 x 60	38,060	6	100	1.200
D91208070	M8 x 70	48,226	6	100	600
D91208080	M8 x 80	53,101	6	100	600
D91210016	M10 x 16	34,068	8	100	1.200
D91210020	M10 x 20	38,233	8	100	1.200
D91210025	M10 x 25	42,070	8	100	1.200
D91210030	M10 x 30	45,060	8	100	1.200
D91210035	M10 x 35	54,707	8	100	600
D91210040	M10 x 40	57,083	8	100	600
D91210045	M10 x 45	58,667	8	100	600
D91210050	M10 x 50	70,969	8	100	600
D91210060	M10 x 60	69,120	8	100	600
D91210070	M10 x 70	79,255	8	100	600
D91210080	M10 x 80	92,197	8	50	600
D91210090	M10 x 90	100,127	8	50	300
D91210100	M10 x 100	112,249	8	50	300
D91212020	M12 x 20	55,497	10	100	600
D91212025	M12 x 25	60,441	10	100	600
D91212030	M12 x 30	61,317	10	100	600
D91212035	M12 x 35	71,589	10	100	600
D91212040	M12 x 40	73,904	10	100	600
D91212045	M12 x 45	75,962	10	100	600
D91212050	M12 x 50	91,920	10	50	600
D91212060	M12 x 60	92,875	10	50	300
D91212070	M12 x 70	107,049	10	50	300
D91212080	M12 x 80	120,555	10	50	300
D91212090	M12 x 90	135,627	10	50	300
D91212100	M12 x 100	151,899	10	50	300
D91212110	M12 x 110	193,230	10	50	300
D91212120	M12 x 120	207,491	10	50	300



Disponibles en varios recubrimientos. Consulte precio y plazo de entrega.



Caja ventana

CÓDIGO	MEDIDA	€/CAJA	PCS	CAJAS
VD91204010	M4 x 10	11,174	150	8
VD91204012	M4 x 12	11,866	125	8
VD91204020	M4 x 20	10,156	100	8
VD91204030	M4 x 30	5,619	40	8
VD91204040	M4 x 40	3,983	20	8
VD91204050	M4 x 50	5,929	20	8
VD91205010	M5 x 10	9,675	100	8
VD91205012	M5 x 12	9,489	100	8
VD91205016	M5 x 16	8,274	90	8
VD91205020	M5 x 20	7,020	70	8
VD91205025	M5 x 25	7,194	60	8
VD91205030	M5 x 30	6,119	40	8
VD91205040	M5 x 40	4,151	20	8
VD91205050	M5 x 50	4,471	20	8
VD91206010	M6 x 10	6,392	50	8
VD91206012	M6 x 12	7,174	50	8
VD91206016	M6 x 16	6,280	50	8
VD91206020	M6 x 20	7,121	50	8
VD91206025	M6 x 25	10,456	50	8
VD91206030	M6 x 30	7,419	35	8
VD91206040	M6 x 40	7,043	30	8
VD91206050	M6 x 50	4,579	15	8
VD91206060	M6 x 60	4,958	15	8
VD91208010	M8 x 10	6,905	30	8
VD91208016	M8 x 16	7,826	30	8
VD91208020	M8 x 20	7,541	30	8
VD91208030	M8 x 30	6,789	20	8
VD91208040	M8 x 40	10,124	20	8
VD91208050	M8 x 50	5,505	10	8
VD91208060	M8 x 60	5,939	10	8

DIN-603/934 Tornillo con cabeza redonda con cuello cuadrado y tuerca hexagonal

METAL



CÓDIGO	MEDIDA	€/100				CÓDIGO	MEDIDA	€/100			
D603905016	M5 x 16	8,323	PC5	500	6.000	D603908120	M8 x 120	71,047	PC8	50	300
D603905020	M5 x 20	9,207	PC5	500	3.000	D603908130	M8 x 130	73,363	PC8	50	300
D603905025	M5 x 25	9,650	PC5	500	3.000	D603908140	M8 x 140	81,233	PC8	50	300
D603905030	M5 x 30	9,787	PC5	500	3.000	D603908150	M8 x 150	87,957	PC8	50	300
D603905035	M5 x 35	11,362	PC5	200	2.400	D603910020	M10 x 20	46,614	PC10	100	600
D603905040	M5 x 40	12,900	PC5	200	2.400	D603910025	M10 x 25	47,329	PC10	100	600
D603905045	M5 x 45	14,980	PC5	200	2.400	D603910030	M10 x 30	49,447	PC10	100	600
D603905050	M5 x 50	16,590	PC5	200	2.400	D603910035	M10 x 35	57,530	PC10	100	600
D603905060	M5 x 60	19,707	PC5	100	1.200	D603910040	M10 x 40	58,470	PC10	100	600
D603905070	M5 x 70	21,613	PC5	100	1.200	D603910045	M10 x 45	59,151	PC10	100	600
D603905080	M5 x 80	25,907	PC5	100	1.200	D603910050	M10 x 50	63,387	PC10	100	600
D603906016	M6 x 16	12,580	PC5	200	2.400	D603910060	M10 x 60	67,666	PC10	50	300
D603906020	M6 x 20	13,318	PC6	200	2.400	D603910070	M10 x 70	83,776	PC10	50	300
D603906025	M6 x 25	15,395	PC6	200	2.400	D603910080	M10 x 80	92,967	PC10	50	300
D603906030	M6 x 30	16,971	PC6	200	1.200	D603910090	M10 x 90	101,113	PC10	50	300
D603906035	M6 x 35	17,551	PC6	200	2.400	D603910100	M10 x 100	106,097	PC10	50	300
D603906040	M6 x 40	17,633	PC6	200	1.200	D603910110	M10 x 110	119,790	PC10	25	300
D603906045	M6 x 45	18,263	PC6	200	1.200	D603910120	M10 x 120	129,786	PC10	25	300
D603906050	M6 x 50	20,566	PC6	200	1.200	D603910130	M10 x 130	149,406	PC10	25	150
D603906060	M6 x 60	22,016	PC6	100	1.200	D603910140	M10 x 140	151,100	PC10	25	150
D603906070	M6 x 70	28,237	PC6	100	1.200	D603910150	M10 x 150	161,120	PC10	25	150
D603906080	M6 x 80	29,227	PC6	100	600	D603910160	M10 x 160	180,948	PC10	25	100
D603906090	M6 x 90	37,890	PC6	100	600	D603910180	M10 x 180	196,030	PC10	25	100
D603906100	M6 x 100	45,933	PC6	100	600	D603910200	M10 x 200	207,130	PC10	25	75
D603906110	M6 x 110	46,767	PC6	100	600	D603912030	M12 x 30	89,647	PC12	50	300
D603906120	M6 x 120	49,312	PC6	100	600	D603912035	M12 x 35	94,433	PC12	50	300
D603906130	M6 x 130	56,228	PC6	100	600	D603912040	M12 x 40	105,057	PC12	50	300
D603906140	M6 x 140	78,628	PC6	100	600	D603912045	M12 x 45	108,520	PC12	50	300
D603906150	M6 x 150	81,757	PC6	100	600	D603912050	M12 x 50	114,173	PC12	50	300
D603908016	M8 x 16	23,930	PC8	200	1.200	D603912060	M12 x 60	136,770	PC12	25	300
D603908020	M8 x 20	23,983	PC8	200	1.200	D603912070	M12 x 70	169,167	PC12	25	300
D603908025	M8 x 25	26,406	PC8	200	1.200	D603912080	M12 x 80	173,970	PC12	25	150
D603908030	M8 x 30	28,933	PC8	200	1.200	D603912100	M12 x 100	178,023	PC12	25	150
D603908035	M8 x 35	29,583	PC8	200	1.200	D603912120	M12 x 120	195,993	PC12	25	150
D603908040	M8 x 40	30,458	PC8	200	1.200	D603912140	M12 x 140	234,849	PC12	25	150
D603908045	M8 x 45	38,785	PC8	200	1.200	D603912160	M12 x 160	284,692	PC12	25	100
D603908050	M8 x 50	40,605	PC8	100	1.200	D603912180	M12 x 180	282,910	PC12	25	100
D603908060	M8 x 60	42,437	PC8	100	600	D603912200	M12 x 200	294,957	PC12	10	40
D603908070	M8 x 70	43,951	PC8	100	600	D603912220	M12 x 220	359,753	PC12	10	30
D603908080	M8 x 80	53,473	PC8	100	400	D603912240	M12 x 240	470,932	PC12	10	30
D603908090	M8 x 90	57,987	PC8	100	600	D603912260	M12 x 260	471,243	PC12	10	20
D603908100	M8 x 100	65,873	PC8	100	600	D603912280	M12 x 280	489,263	PC12	10	20
D603908110	M8 x 110	68,525	PC8	50	300	D603912300	M12 x 300	526,038	PC12	10	20

Blíster

CÓDIGO	MEDIDA	€/BOLSA	PCS	BOLSAS
BZ603905020	M5 x 20	2,582	10	15
BZ603905030	M5 x 30	2,582	10	15
BZ603905040	M5 x 40	2,582	4	15
BZ603905050	M5 x 50	2,582	4	15
BZ603906016	M6 x 16	2,582	4	15
BZ603906020	M6 x 20	2,582	4	15
BZ603906030	M6 x 30	2,582	4	15
BZ603906040	M6 x 40	2,582	4	15
BZ603906050	M6 x 50	2,582	4	15
BZ603906060	M6 x 60	2,582	2	15
BZ603906070	M6 x 70	2,582	2	15
BZ603906080	M6 x 80	2,582	2	15
BZ603908025	M8 x 25	2,582	4	15
BZ603908030	M8 x 30	2,582	4	15
BZ603908040	M8 x 40	2,582	4	15
BZ603908050	M8 x 50	2,582	2	15
BZ603908060	M8 x 60	2,582	2	15
BZ603908070	M8 x 70	2,582	2	15
BZ603908080	M8 x 80	2,582	2	12
BZ603908090	M8 x 90	2,582	2	12
BZ603910025	M10 x 25	2,582	2	10
BZ603910030	M10 x 30	2,582	2	10
BZ603910040	M10 x 40	2,582	2	10
BZ603910050	M10 x 50	2,582	2	10

Caja ventana

CÓDIGO	MEDIDA	€/CAJA	PCS	CAJAS
VD603905020	M5 x 20	5,842	50	8
VD603905030	M5 x 30	5,862	40	8
VD603905040	M5 x 40	6,933	40	8
VD603905050	M5 x 50	7,832	35	8
VD603906016	M6 x 16	4,804	30	8
VD603906020	M6 x 20	5,332	30	8
VD603906030	M6 x 30	5,847	30	8
VD603906040	M6 x 40	5,843	25	8
VD603906050	M6 x 50	6,712	25	8
VD603906060	M6 x 60	7,505	25	8
VD603906070	M6 x 70	9,406	25	8
VD603906080	M6 x 80	7,544	20	8
VD603908025	M8 x 25	5,769	15	8
VD603908030	M8 x 30	5,956	15	8
VD603908040	M8 x 40	5,796	15	8
VD603908050	M8 x 50	7,270	15	8
VD603908060	M8 x 60	6,527	12	8
VD603908070	M8 x 70	6,167	10	8
VD603908080	M8 x 80	6,913	10	8
VD603908090	M8 x 90	8,333	10	8
VD603908100	M8 x 100	8,364	10	8
VD603910025	M10 x 25	8,559	15	8
VD603910030	M10 x 30	7,449	10	8
VD603910040	M10 x 40	7,731	10	8
VD603910050	M10 x 50	7,847	8	8
VD603910060	M10 x 60	8,967	8	8
VD603910070	M10 x 70	9,268	8	8
VD603910080	M10 x 80	10,563	8	8

Tornillo con cabeza redonda y cuello cuadrado. Inoxidable A2

DIN-603 A2



CÓDIGO	MEDIDA	€/100		
D603I08016	M8 x 16	42,047	200	2.400



Disponible en varios recubrimientos. Consulte precio y plazo de entrega.

Tornillo arado con cabeza avellanada 8.8. Con tuerca

DIN-608



CÓDIGO	MEDIDA	€/100		
D60810035	10 x 35	45,005	100	600
D60810040	10 x 40	49,100	100	600
D60810045	10 x 45	50,634	100	600
D60810050	10 x 50	57,358	100	400
D60810060	10 x 60	66,876	100	400
D60811040	11 x 40	54,320	50	300
D60811045	11 x 45	57,855	50	300
D60811050	11 x 50	67,865	50	300
D60811060	11 x 60	73,143	50	300
D60811070	11 x 70	83,907	50	300

CÓDIGO	MEDIDA	€/100		
D60811080	11 x 80	96,310	50	200
D60811090	11 x 90	112,722	50	200
D60812040	12 x 40	71,446	50	300
D60812045	12 x 45	72,366	50	300
D60812050	12 x 50	73,929	50	300
D60812060	12 x 60	86,708	50	200
D60812070	12 x 70	101,635	50	200
D60812080	12 x 80	104,427	50	200
D60812090	12 x 90	115,845	50	200
D60812100	12 x 100	125,515	50	200



Disponible en varios recubrimientos. Consulte precio y plazo de entrega.

Tornillo ranurado, cabeza cilíndrica, 4.8

DIN-84



CÓDIGO	MEDIDA	€/100		
T0840304Z	M3 x 4	1,898	1.000	45.000
T0840306Z	M3 x 6	1,904	1.000	30.000
T0840308Z	M3 x 8	2,127	1.000	30.000
T0840310Z	M3 x 10	2,167	1.000	24.000
T0840312Z	M3 x 12	2,389	1.000	24.000
T0840316Z	M3 x 16	2,760	1.000	16.000
T0840320Z	M3 x 20	2,922	1.000	12.000
T0840325Z	M3 x 25	3,115	1.000	12.000
T0840330Z	M3 x 30	3,984	500	6.000
T0840335Z	M3 x 35	4,378	500	6.000
T0840340Z	M3 x 40	4,973	500	6.000
T0840406Z	M4 x 6	2,604	500	15.000
T0840408Z	M4 x 8	2,618	500	12.000
T0840410Z	M4 x 10	3,027	500	12.000
T0840412Z	M4 x 12	3,113	500	12.000
T0840416Z	M4 x 16	3,597	500	8.000
T0840420Z	M4 x 20	3,754	500	8.000
T0840425Z	M4 x 25	3,935	500	6.000
T0840435Z	M4 x 35	6,235	250	3.000
T0840445Z	M4 x 45	7,707	250	3.000
T0840450Z	M4 x 50	9,454	250	3.000
T0840460Z	M4 x 60	12,983	250	3.000
T0840470Z	M4 x 70	14,331	100	1.200
T0840506Z	M5 x 6	3,678	500	8.000

CÓDIGO	MEDIDA	€/100		
T0840508Z	M5 x 8	4,047	500	12.000
T0840510Z	M5 x 10	4,267	500	8.000
T0840512Z	M5 x 12	4,631	250	7.500
T0840516Z	M5 x 16	5,451	250	6.000
T0840520Z	M5 x 20	5,790	250	6.000
T0840525Z	M5 x 25	5,912	250	4.000
T0840530Z	M5 x 30	6,954	250	4.000
T0840535Z	M5 x 35	8,160	250	3.000
T0840540Z	M5 x 40	8,982	250	3.000
T0840545Z	M5 x 45	9,903	250	3.000
T0840550Z	M5 x 50	10,809	250	3.000
T0840560Z	M5 x 60	13,705	250	1.500
T0840608Z	M6 x 8	5,839	250	1.500
T0840610Z	M6 x 10	5,988	250	4.000
T0840616Z	M6 x 16	8,000	250	4.000
T0840620Z	M6 x 20	9,157	250	3.000
T0840625Z	M6 x 25	9,152	250	3.000
T0840630Z	M6 x 30	11,083	250	3.000
T0840635Z	M6 x 35	11,644	250	1.500
T0840640Z	M6 x 40	12,367	250	1.500
T0840645Z	M6 x 45	14,093	250	1.500
T0840650Z	M6 x 50	14,749	250	1.500
T0840660Z	M6 x 60	18,119	250	1.500



Disponible en varios recubrimientos. Consulte precio y plazo de entrega.

DIN-7985

Tornillo rosca métrica con cabeza alomada PH, 4.8

METAL



Disponible en varios recubrimientos. Consulte precio y plazo de entrega.

CÓDIGO	MEDIDA	€/100	PH	1.000	30.000	CÓDIGO	MEDIDA	€/100	PH	500	8.000
T9850306Z	M3 x 6	1,759	PH1	1.000	30.000	T9850510Z	M5 x 10	4,597	PH2	500	8.000
T9850308Z	M3 x 8	1,782	PH1	1.000	30.000	T9850512Z	M5 x 12	4,972	PH2	250	6.000
T9850310Z	M3 x 10	1,801	PH1	1.000	24.000	T9850516Z	M5 x 16	5,387	PH2	250	4.000
T9850312Z	M3 x 12	2,043	PH1	1.000	24.000	T9850520Z	M5 x 20	5,900	PH2	250	4.000
T9850316Z	M3 x 16	2,193	PH1	1.000	16.000	T9850525Z	M5 x 25	6,796	PH2	250	4.000
T9850320Z	M3 x 20	2,560	PH1	1.000	12.000	T9850530Z	M5 x 30	7,497	PH2	250	2.000
T9850325Z	M3 x 25	2,719	PH1	500	12.000	T9850535Z	M5 x 35	8,751	PH2	250	3.000
T9850330Z	M3 x 30	3,012	PH1	500	12.000	T9850540Z	M5 x 40	9,490	PH2	250	3.000
T9850406Z	M4 x 6	2,847	PH2	500	12.000	T9850545Z	M5 x 45	9,917	PH2	250	2.000
T9850408Z	M4 x 8	2,855	PH2	500	12.000	T9850550Z	M5 x 50	11,315	PH2	250	2.000
T9850410Z	M4 x 10	2,873	PH2	500	12.000	T9850608Z	M6 x 8	7,018	PH3	250	6.000
T9850412Z	M4 x 12	2,883	PH2	500	8.000	T9850610Z	M6 x 10	7,204	PH3	250	4.000
T9850416Z	M4 x 16	3,337	PH2	500	8.000	T9850612Z	M6 x 12	7,274	PH3	250	4.000
T9850420Z	M4 x 20	3,583	PH2	500	8.000	T9850616Z	M6 x 16	7,640	PH3	250	4.000
T9850425Z	M4 x 25	4,324	PH2	500	6.000	T9850620Z	M6 x 20	8,720	PH3	250	3.000
T9850430Z	M4 x 30	4,781	PH2	500	6.000	T9850625Z	M6 x 25	10,187	PH3	250	3.000
T9850435Z	M4 x 35	5,854	PH2	250	3.000	T9850630Z	M6 x 30	11,346	PH3	250	3.000
T9850440Z	M4 x 40	6,407	PH2	250	3.000	T9850635Z	M6 x 35	12,803	PH3	250	3.000
T9850450Z	M4 x 50	9,520	PH2	250	3.000	T9850640Z	M6 x 40	13,513	PH3	250	1.500
T9850506Z	M5 x 6	4,321	PH2	500	8.000	T9850650Z	M6 x 50	15,804	PH3	250	1.500
T9850508Z	M5 x 8	4,342	PH2	500	8.000	T9850660Z	M6 x 60	17,439	PH3	250	1.500

Blíster

CÓDIGO	MEDIDA	€/BOLSA	PCS	BOLSAS
BZT9850306Z	M3 x 6	2,040	10	20
BZT9850310Z	M3 x 10	2,040	10	20
BZT9850316Z	M3 x 16	2,040	6	20
BZT9850320Z	M3 x 20	2,040	6	20
BZT9850330Z	M3 x 30	2,040	6	20
BZT9850416Z	M4 x 16	2,040	6	20
BZT9850420Z	M4 x 20	2,040	6	20
BZT9850430Z	M4 x 30	2,040	6	20
BZT9850510Z	M5 x 10	2,040	6	20
BZT9850520Z	M5 x 20	2,040	6	20
BZT9850525Z	M5 x 25	2,040	6	20
BZT9850530Z	M5 x 30	2,040	6	20
BZT9850540Z	M5 x 40	2,040	6	20
BZT9850610Z	M6 x 10	2,040	6	20
BZT9850616Z	M6 x 16	2,040	6	20
BZT9850620Z	M6 x 20	2,040	6	20
BZT9850625Z	M6 x 25	2,040	6	20
BZT9850630Z	M6 x 30	2,040	6	20
BZT9850640Z	M6 x 40	2,040	6	15
BZT9850650Z	M6 x 50	2,040	4	15
BZT9850660Z	M6 x 60	2,040	4	15

Caja ventana

CÓDIGO	MEDIDA	€/CAJA	PCS	CAJAS
VT9850306Z	M3 x 6	4,139	150	8
VT9850310Z	M3 x 10	4,261	150	8
VT9850316Z	M3 x 16	4,013	100	8
VT9850320Z	M3 x 20	4,016	100	8
VT9850330Z	M3 x 30	4,617	100	8
VT9850406Z	M4 x 6	4,038	100	8
VT9850408Z	M4 x 8	4,377	100	8
VT9850410Z	M4 x 10	4,472	100	8
VT9850416Z	M4 x 16	5,008	100	8
VT9850420Z	M4 x 20	5,148	100	8
VT9850506Z	M5 x 6	5,547	100	8
VT9850510Z	M5 x 10	5,904	100	8
VT9850512Z	M5 x 12	5,371	70	8
VT9850516Z	M5 x 16	5,497	70	8
VT9850520Z	M5 x 20	5,891	70	8
VT9850530Z	M5 x 30	5,293	50	8
VT9850540Z	M5 x 40	6,709	50	8
VT9850550Z	M5 x 50	8,772	50	8
VT9850610Z	M6 x 10	6,832	70	8
VT9850612Z	M6 x 12	7,288	70	8
VT9850616Z	M6 x 16	7,692	70	8
VT9850620Z	M6 x 20	7,501	50	8
VT9850630Z	M6 x 30	7,369	50	8
VT9850640Z	M6 x 40	9,257	50	8
VT9850650Z	M6 x 50	11,404	50	8
VT9850660Z	M6 x 60	12,219	50	8

Tornillo rosca métrica con cabeza avellanada ranurada, 4.8

DIN-963

METAL



CÓDIGO	MEDIDA	€/100		
T9630410Z	M4 x 10	3,203	500	22.500
T9630412Z	M4 x 12	3,323	500	22.500
T9630416Z	M4 x 16	3,407	500	12.000
T9630420Z	M4 x 20	4,103	500	12.000
T9630430Z	M4 x 30	5,123	500	6.000
T9630440Z	M4 x 40	6,406	250	3.000
T9630450Z	M4 x 50	8,307	250	3.000
T9630510Z	M5 x 10	3,597	500	12.000
T9630512Z	M5 x 12	4,267	500	12.000
T9630516Z	M5 x 16	4,430	250	7.500
T9630520Z	M5 x 20	5,953	250	6.000
T9630525Z	M5 x 25	6,413	250	6.000
T9630530Z	M5 x 30	6,620	250	4.000

CÓDIGO	MEDIDA	€/100		
T9630540Z	M5 x 40	10,220	250	3.000
T9630550Z	M5 x 50	11,574	250	3.000
T9630560Z	M5 x 60	14,641	250	1.500
T9630610Z	M6 x 10	5,817	250	11.250
T9630612Z	M6 x 12	6,060	250	11.250
T9630616Z	M6 x 16	7,229	250	6.000
T9630620Z	M6 x 20	9,440	250	4.000
T9630625Z	M6 x 25	9,629	250	3.000
T9630630Z	M6 x 30	9,821	250	3.000
T9630640Z	M6 x 40	12,983	250	1.500
T9630650Z	M6 x 50	14,737	250	1.500
T9630660Z	M6 x 60	17,150	250	1.500



Disponible en varios recubrimientos. Consulte precio y plazo de entrega.

Tornillo rosca métrica con cabeza avellanada PH, 4.8

DIN-965

METAL



CÓDIGO	MEDIDA	€/100			
T9650306Z	M3 x 6	1,611	PH1	1.000	45.000
T9650308Z	M3 x 8	1,601	PH1	1.000	45.000
T9650310Z	M3 x 10	1,656	PH1	1.000	30.000
T9650312Z	M3 x 12	1,870	PH1	1.000	24.000
T9650316Z	M3 x 16	1,938	PH1	500	22.500
T9650320Z	M3 x 20	2,232	PH1	500	22.500
T9650325Z	M3 x 25	2,706	PH1	500	12.000
T9650408Z	M4 x 8	2,421	PH2	500	22.500
T9650410Z	M4 x 10	2,574	PH2	500	12.000
T9650412Z	M4 x 12	2,634	PH2	500	22.500
T9650416Z	M4 x 16	2,877	PH2	500	12.000
T9650420Z	M4 x 20	3,468	PH2	500	12.000
T9650425Z	M4 x 25	4,453	PH2	500	6.000
T9650430Z	M4 x 30	4,526	PH2	500	6.000
T9650435Z	M4 x 35	4,902	PH2	500	6.000
T9650440Z	M4 x 40	5,916	PH2	250	3.000
T9650450Z	M4 x 50	7,442	PH2	250	3.000
T9650510Z	M5 x 10	3,786	PH2	250	11.250
T9650512Z	M5 x 12	4,119	PH2	250	11.250

CÓDIGO	MEDIDA	€/100			
T9650516Z	M5 x 16	4,638	PH2	250	6.000
T9650520Z	M5 x 20	5,165	PH2	250	6.000
T9650525Z	M5 x 25	5,566	PH2	250	6.000
T9650530Z	M5 x 30	6,378	PH2	250	4.000
T9650535Z	M5 x 35	7,201	PH2	250	6.000
T9650540Z	M5 x 40	8,983	PH2	250	3.000
T9650550Z	M5 x 50	9,528	PH2	250	3.000
T9650560Z	M5 x 60	13,514	PH2	250	1.500
T9650610Z	M6 x 10	5,661	PH3	250	6.000
T9650612Z	M6 x 12	5,499	PH3	250	6.000
T9650616Z	M6 x 16	5,910	PH3	250	6.000
T9650620Z	M6 x 20	7,335	PH3	250	4.000
T9650625Z	M6 x 25	8,097	PH3	250	3.000
T9650630Z	M6 x 30	9,999	PH3	250	3.000
T9650635Z	M6 x 35	9,801	PH3	250	3.000
T9650640Z	M6 x 40	12,279	PH3	250	1.500
T9650650Z	M6 x 50	14,202	PH3	250	1.500
T9650660Z	M6 x 60	18,890	PH3	100	1.200



Disponible en varios recubrimientos. Consulte precio y plazo de entrega.

Blíster

CÓDIGO	MEDIDA	€/BOLSA	PCS	BOLSAS
BZT9650410Z	M4 x 10	2,040	6	20
BZT9650420Z	M4 x 20	2,040	6	20
BZT9650430Z	M4 x 30	2,040	6	20
BZT9650510Z	M5 x 10	2,040	6	20
BZT9650520Z	M5 x 20	2,040	6	20
BZT9650525Z	M5 x 25	2,040	6	20
BZT9650530Z	M5 x 30	2,040	6	20
BZT9650620Z	M6 x 20	2,040	6	20
BZT9650630Z	M6 x 30	2,040	6	20
BZT9650640Z	M6 x 40	2,040	6	20

Caja ventana

CÓDIGO	MEDIDA	€/CAJA	PCS	CAJAS
VT9650306Z	M3 x 6	4,506	200	8
VT9650310Z	M3 x 10	4,378	200	8
VT9650408Z	M4 x 8	3,594	100	8
VT9650410Z	M4 x 10	3,637	100	8
VT9650416Z	M4 x 16	3,877	100	8
VT9650420Z	M4 x 20	4,575	100	8
VT9650425Z	M4 x 25	5,738	100	8
VT9650430Z	M4 x 30	5,922	100	8
VT9650510Z	M5 x 10	3,983	70	8
VT9650516Z	M5 x 16	4,492	70	8
VT9650520Z	M5 x 20	4,647	70	8
VT9650530Z	M5 x 30	3,915	50	8
VT9650540Z	M5 x 40	5,615	50	8
VT9650610Z	M6 x 10	5,149	70	8
VT9650616Z	M6 x 16	5,593	70	8
VT9650620Z	M6 x 20	6,403	70	8
VT9650630Z	M6 x 30	5,946	50	8

DIN-934

Tuerca hexagonal

DIN-934

Zincada

METAL



Disponible en varios recubrimientos. Consulte precio y plazo de entrega.

CÓDIGO	MEDIDA	€/100	LLAVE DE INSTALACIÓN		
D93403	M3	1,206	5,5	500	22.500
D93404	M4	1,273	7	1.000	45.000
D93405	M5	1,618	8	500	12.000
D93406	M6	2,509	10	500	12.000
D93408	M8	4,877	13	250	6.000
D93410	M10	10,816	17	250	3.000
D93412	M12	16,198	19	250	1.500
D93414	M14	24,527	22	100	1.200
D93416	M16	34,659	24	100	600
D93418	M18	50,518	27	100	600
D93420	M20	60,683	30	50	600
D93422	M22	90,523	32	50	300
D93424	M24	132,450	36	25	300
D93427	M27	203,307	41	25	150
D93430	M30	269,976	46	25	150
D93433	M33	388,919	50	10	120
D93436	M36	473,517	55	10	60



Blíster

CÓDIGO	MEDIDA	€/BOLSA	PCS	BOLSAS
BZ934ZM03	M3	2,040	40	20
BZ934ZM04	M4	2,040	40	20
BZ934ZM05	M5	2,040	40	20
BZ934ZM06	M6	2,040	20	20
BZ934ZM08	M8	2,040	10	20
BZ934ZM10	M10	2,040	10	15
BZ934ZM12	M12	2,040	6	15



Caja ventana

CÓDIGO	MEDIDA	€/CAJA	PCS	CAJAS
VD93403	M3	2,940	150	8
VD93404	M4	3,003	150	8
VD93405	M5	2,557	100	8
VD93406	M6	3,620	100	8
VD93408	M8	3,622	50	8
VD93410	M10	4,693	30	8
VD93412	M12	4,942	20	8

DIN-934 A2

Inoxidable A2

INOXIDABLE



CÓDIGO	MEDIDA	€/100	LLAVE DE INSTALACIÓN		
D934IM04	M4	3,590	7	500	22.500
D934IM05	M5	4,150	8	500	12.000
D934IM06	M6	6,850	10	500	12.000
D934IM08	M8	13,897	13	250	4.000
D934IM10	M10	30,997	17	250	2.000
D934IM12	M12	45,447	19	250	1.500
D934IM14	M14	69,167	22	100	800
D934IM16	M16	97,060	24	100	600
D934IM18	M18	154,370	27	100	600
D934IM20	M20	202,697	30	50	400
D934IM22	M22	280,170	32	50	300
D934IM24	M24	364,217	36	25	200



Blíster

CÓDIGO	MEDIDA	€/BOLSA	PCS	BOLSAS
BZ934IM04	M4	2,582	10	20
BZ934IM05	M5	2,582	8	20
BZ934IM06	M6	2,582	8	20
BZ934IM08	M8	2,582	6	20
BZ934IM10	M10	2,582	5	15



Caja ventana

CÓDIGO	MEDIDA	€/CAJA	PCS	CAJAS
VD934IM04	M4	2,799	50	8
VD934IM05	M5	3,237	50	8
VD934IM06	M6	4,806	50	8
VD934IM08	M8	5,850	30	8
VD934IM10	M10	8,700	20	8



Tuerca autoblocante

DIN-985

METAL



DIN-985

Zincada

CÓDIGO	MEDIDA	€/100	LLAVE DE INSTALACIÓN		
DZ98503	M3	2,403	5,5	500	22.500
DZ98504	M4	2,373	7	500	12.000
DZ98505	M5	2,543	8	500	12.000
DZ98506	M6	3,543	10	500	12.000
DZ98508	M8	6,327	13	250	6.000
DZ98510	M10	14,007	17	250	2.000
DZ98512	M12	22,053	19	100	1.200
DZ98514	M14	37,303	22	100	1.200
DZ98516	M16	45,463	24	50	600
DZ98518	M18	75,223	27	50	600
DZ98520	M20	94,577	30	25	300
DZ98522	M22	153,563	32	25	300
DZ98524	M24	186,643	36	25	300
DZ98527	M27	369,520	41	15	180
DZ98530	M30	625,197	46	15	90



Disponible en varios recubrimientos. Consulte precio y plazo de entrega.

Blíster

CÓDIGO	MEDIDA	€/BOLSA	PCS BOLSAS	BOLSAS
BZZ98503	M3	2,040	20	20
BZZ98504	M4	2,040	20	20
BZZ98505	M5	2,040	20	20
BZZ98506	M6	2,040	10	20
BZZ98508	M8	2,040	5	20
BZZ98510	M10	2,040	5	15
BZZ98512	M12	2,040	3	15

Caja ventana

CÓDIGO	MEDIDA	€/CAJA	PCS CAJAS	CAJAS
VDZ98503	M3	3,835	100	8
VDZ98504	M4	3,835	100	8
VDZ98505	M5	4,001	100	8
VDZ98506	M6	4,617	80	8
VDZ98508	M8	4,581	50	8
VDZ98510	M10	5,111	25	8
VDZ98512	M12	5,120	15	8

INOXIDABLE



DIN-985 A2

Inoxidable A2

CÓDIGO	MEDIDA	€/100	LLAVE DE INSTALACIÓN		
D985IM04	M4	6,440	7	500	22.500
D985IM05	M5	6,933	8	500	8.000
D985IM06	M6	9,797	10	500	8.000
D985IM08	M8	20,447	13	250	4.000
D985IM10	M10	41,130	17	250	2.000
D985IM12	M12	63,930	19	100	1.200
D985IM14	M14	121,010	22	100	800
D985IM16	M16	146,667	24	50	600
D985IM18	M18	335,650	27	50	400
D985IM20	M20	430,477	30	25	300
D985IM22	M22	974,347	32	25	300
D985IM24	M24	1.313,707	36	25	150



DIN-6923

Tuerca brida grafilada

DIN-6923

METAL



Zincada



Disponible en varios recubrimientos. Consulte precio y plazo de entrega.

CÓDIGO	MEDIDA	€/100	LLAVE DE INSTALACIÓN		
D692304	M4	2,333	7	500	15.000
D692305	M5	2,784	8	500	12.000
D692306	M6	4,114	10	500	8.000
D692308	M8	8,009	13	250	3.000
D692310	M10	13,069	15	250	2.000
D692312	M12	21,214	18	250	1.000
D692314	M14	37,098	21	100	600
D692316	M16	46,625	24	100	400

DIN-6923 A2

METAL



Tuerca brida grafilada DIN-6923. Inoxidable A2



CÓDIGO	MEDIDA	€/100	LLAVE DE INSTALACIÓN	Nº HUELLA		
D6923IM08	M8	24,660	13	13	250	3.000
D6923IM10	M10	47,753	15	17	250	3.000
D6923IM12	M12	70,740	18	19	250	1.500

DIN-1587

Tuerca ciega

METAL



Disponible en varios recubrimientos. Consulte precio y plazo de entrega.

CÓDIGO	MEDIDA	€/100	LLAVE DE INSTALACIÓN		
D158704	M4	4,747	7	500	15.000
D158705	M5	5,802	8	250	7.500
D158706	M6	5,938	10	250	4.000
D158708	M8	11,583	13	100	2.400
D158710	M10	22,337	17	100	1.600
D158712	M12	33,899	19	50	800
D158714	M14	61,938	22	50	600
D158716	M16	61,391	24	25	300



Blíster

CÓDIGO	MEDIDA	€/BOLSA	PCS	BOLSAS
BZ158704	M4	2,040	20	20
BZ158705	M5	2,040	20	20
BZ158706	M6	2,040	10	20
BZ158708	M8	2,040	5	20
BZ158710	M10	2,040	5	20
BZ158712	M12	2,040	3	20



Caja ventana

CÓDIGO	MEDIDA	€/CAJA	PCS	CAJAS
VD158704	M4	5,454	75	8
VD158705	M5	4,262	50	8
VD158706	M6	4,568	50	8
VD158708	M8	4,457	25	8
VD158710	M10	6,874	20	8
VD158712	M12	5,217	10	8

Arandela plana

DIN-125

METAL



DIN-125

Zincada

CÓDIGO	MEDIDA	€/100		
D12503	M3	0,660	1.000	45.000
D12504	M4	0,947	1.000	45.000
D12505	M5	1,187	1.000	45.000
D12506	M6	1,747	500	22.500
D12508	M8	3,128	250	11.250
D12510	M10	5,619	250	6.000
D12512	M12	9,253	250	3.000
D12514	M14	11,887	200	2.400
D12516	M16	15,167	100	1.600
D12518	M18	19,973	100	2.400
D12520	M20	24,371	50	1.200
D12522	M22	38,405	50	1.200
D12524	M24	52,018	50	600
D12527	M27	70,756	50	600
D12530	M30	94,149	50	300
D12533	M33	147,398	50	300
D12536	M36	198,706	25	300



Disponible en varios recubrimientos. Consulte precio y plazo de entrega.

Blíster

CÓDIGO	MEDIDA	€/BOLSA	PCS	BOLSAS
BZ125ZM03	M3	2,040	40	20
BZ125ZM04	M4	2,040	40	20
BZ125ZM05	M5	2,040	40	20
BZ125ZM06	M6	2,040	20	20
BZ125ZM08	M8	2,040	10	20
BZ125ZM10	M10	2,040	10	20
BZ125ZM12	M12	2,040	6	20

Caja ventana

CÓDIGO	MEDIDA	€/CAJA	PCS	CAJAS
VD12503	M3	3,350	200	8
VD12504	M4	3,815	200	8
VD12505	M5	3,029	150	8
VD12506	M6	3,591	100	8
VD12508	M8	4,188	75	8
VD12510	M10	7,756	75	8
VD12512	M12	9,139	50	8

INOXIDABLE



DIN-125 A2

Inoxidable A2

CÓDIGO	MEDIDA	€/100		
D125IM04	M4	1,217	500	22.500
D125IM05	M5	1,610	500	22.500
D125IM06	M6	2,917	500	22.500
D125IM08	M8	5,003	250	11.250
D125IM10	M10	9,557	250	6.000
D125IM12	M12	19,037	250	3.000
D125IM14	M14	26,643	200	2.400
D125IM16	M16	29,420	100	2.400
D125IM18	M18	43,627	100	1.600
D125IM20	M20	46,327	50	1.200
D125IM22	M22	54,937	50	1.200
D125IM24	M24	96,120	50	600



Blíster

CÓDIGO	MEDIDA	€/BOLSA	PCS	BOLSAS
BZ125IM04	M4	2,582	10	20
BZ125IM05	M5	2,582	8	20
BZ125IM06	M6	2,582	8	20
BZ125IM08	M8	2,582	6	20
BZ125IM10	M10	2,582	5	20

Caja ventana

CÓDIGO	MEDIDA	€/CAJA	PCS	CAJAS
VD125IM04	M4	3,225	100	8
VD125IM05	M5	3,235	75	8
VD125IM06	M6	4,091	75	8
VD125IM08	M8	4,265	50	8
VD125IM10	M10	7,107	50	8

DIN-9021

Arandela plana ancha

METAL



DIN-9021

Zincada



Disponible en varios recubrimientos. Consulte precio y plazo de entrega.

CÓDIGO	MEDIDA	€/100		
D902103	M3	1,450	500	22.500
D902104	M4	1,467	500	12.000
D902105	M5	2,107	500	12.000
D902106	M6	3,217	500	12.000
D902108	M8	7,680	200	4.800
D902110	M10	13,503	100	2.400
D902112	M12	27,540	100	1.200
D902114	M14	38,477	100	800
D902116	M16	46,480	50	600
D902118	M18	85,287	50	600
D902120	M20	92,750	25	300
D902122	M22	179,087	25	300
D902124	M24	203,810	25	150



Blíster

CÓDIGO	MEDIDA	€/BOLSA	PCS	BOLSAS
BZ902103	M3	2,040	20	20
BZ902104	M4	2,040	20	20
BZ902105	M5	2,040	20	20
BZ902106	M6	2,040	10	20
BZ902108	M8	2,040	5	20
BZ902110	M10	2,040	5	20
BZ902112	M12	2,040	4	20



Caja ventana

CÓDIGO	MEDIDA	€/CAJA	PCS	CAJAS
VD902103	M3	3,360	125	8
VD902104	M4	3,360	125	8
VD902105	M5	4,233	125	8
VD902106	M6	4,712	100	8
VD902108	M8	5,296	50	8
VD902110	M10	5,399	30	8
VD902112	M12	5,121	15	8

DIN-9021 A2

Inoxidable A2

INOXIDABLE



CÓDIGO	MEDIDA	€/100		
D9021IM04	M4	2,460	500	22.500
D9021IM05	M5	4,410	500	12.000
D9021IM06	M6	7,990	500	8.000
D9021IM08	M8	16,463	200	4.800
D9021IM10	M10	35,630	100	1.600
D9021IM12	M12	61,450	100	800
D9021IM14	M14	138,600	100	800
D9021IM16	M16	134,200	50	600
D9021IM18	M18	240,293	50	400
D9021IM20	M20	257,160	25	300
D9021IM22	M22	277,533	25	200
D9021IM24	M24	326,100	25	150



Blíster

CÓDIGO	MEDIDA	€/BOLSA	PCS	BOLSAS
BZ9021IM04	M4	2,582	10	20
BZ9021IM05	M5	2,582	8	20
BZ9021IM06	M6	2,582	8	20
BZ9021IM08	M8	2,582	6	20
BZ9021IM10	M10	2,582	5	20



Caja ventana

CÓDIGO	MEDIDA	€/CAJA	PCS	CAJAS
VD9021IM04	M4	3,667	100	8
VD9021IM05	M5	4,525	75	8
VD9021IM06	M6	8,049	75	8
VD9021IM08	M8	8,623	40	8
VD9021IM10	M10	9,754	20	8

Arandela muelle Grower

DIN-127

METAL



CÓDIGO	MEDIDA	€/100		
D12703	M3	0,580	500	22.500
D12704	M4	0,746	500	22.500
D12705	M5	0,959	500	22.500
D12706	M6	1,353	500	12.000
D12708	M8	2,845	200	4.800
D12710	M10	4,537	100	2.400
D12712	M12	6,683	100	2.400
D12714	M14	9,780	100	2.400
D12716	M16	15,780	50	1.200
D12718	M18	17,197	50	1.200
D12720	M20	24,527	25	300
D12722	M22	27,587	25	600
D12724	M24	49,277	25	600
D12727	M27	72,793	25	600
D12730	M30	134,757	25	300
D12736	M36	273,407	25	300

DIN-127

Arandela muelle Grower



Disponible en varios recubrimientos. Consulte precio y plazo de entrega.

Blíster

CÓDIGO	MEDIDA	€/BOLSA	PCS BOLSAS	BOLSAS
BZ12703	M3	2,040	20	20
BZ12704	M4	2,040	20	20
BZ12705	M5	2,040	20	20
BZ12706	M6	2,040	10	20
BZ12708	M8	2,040	5	20
BZ12710	M10	2,040	5	20
BZ12712	M12	2,040	4	20

Caja ventana

CÓDIGO	MEDIDA	€/CAJA	PCS CAJAS	CAJAS
VD12704	M4	2,670	100	8
VD12705	M5	2,946	100	8
VD12706	M6	3,692	100	8
VD12708	M8	3,572	50	8
VD12710	M10	3,259	25	8
VD12712	M12	4,236	25	8

METAL



CÓDIGO	MEDIDA	€/100		
D127IM08	M8	4,530	200	9.000
D127IM10	M10	7,237	100	4.500
D127IM12	M12	10,923	100	4.500

DIN-127 A2

Arandela muelle grower DIN-127. Inoxidable A2



Tuerca mariposa

TU-MA

METAL



CÓDIGO	MEDIDA	€/100		
TUMAM03	M3	12,027	500	12.000
TUMAM04	M4	11,500	500	8.000
TUMAM05	M5	11,997	250	6.000
TUMAM06	M6	13,473	250	6.000
TUMAM08	M8	18,731	100	2.400
TUMAM10	M10	29,507	100	1.600
TUMAM12	M12	57,892	50	1.200
TUMAM14	M14	197,400	50	-
TUMAM16	M16	208,178	25	300



Disponible en varios recubrimientos. Consulte precio y plazo de entrega.

Blíster

CÓDIGO	MEDIDA	€/BOLSA	PCS BOLSAS	BOLSAS
BZTUMAM03	M3	2,582	10	20
BZTUMAM04	M4	2,582	10	20
BZTUMAM05	M5	2,582	10	20
BZTUMAM06	M6	2,582	10	20
BZTUMAM08	M8	2,582	5	20
BZTUMAM10	M10	2,582	5	20
BZTUMAM12	M12	2,582	3	20

Caja ventana

CÓDIGO	MEDIDA	€/CAJA	PCS CAJAS	CAJAS
VTUMAM03	M3	11,658	75	8
VTUMAM04	M4	11,148	75	8
VTUMAM05	M5	8,069	50	8
VTUMAM06	M6	8,709	50	8
VTUMAM08	M8	6,057	25	8
VTUMAM10	M10	7,935	20	8
VTUMAM12	M12	7,783	10	8

DIN-6798 A Arandela dentada exterior



Disponible en varios recubrimientos. Consulte precio y plazo de entrega.

CÓDIGO	MEDIDA	€/100		
D6798A03	M3	1,165	500	22.500
D6798A04	M4	1,205	500	22.500
D6798A05	M5	1,441	500	22.500
D6798A06	M6	2,010	500	22.500
D6798A08	M8	3,649	250	11.250
D6798A10	M10	6,622	250	11.250
D6798A12	M12	8,380	100	4.500
D6798A14	M14	12,915	100	4.500
D6798A16	M16	16,170	100	4.500

ISO 7380 Tornillo allen con cabeza redonda de acero calidad 10.9

NEW



CÓDIGO	MEDIDA	€/100				CÓDIGO	MEDIDA	€/100			
T738003012	M3 x 12	-	2	1.000	30.000	T738006030	M6 x 30	-	4	250	3.000
T738003016	M3 x 16	-	2	1.000	24.000	T738006035	M6 x 35	-	4	250	3.000
T738003020	M3 x 20	-	2	1.000	24.000	T738006040	M6 x 40	-	4	250	3.000
T738004008	M4 x 8	-	2.5	500	22.500	T738006045	M6 x 45	-	4	250	2.000
T738004010	M4 x 10	-	2.5	500	22.500	T738006050	M6 x 50	-	4	250	1.500
T738004016	M4 x 16	-	2.5	500	12.000	T738006060	M6 x 60	-	4	250	1.500
T738004020	M4 x 20	-	2.5	500	-	T738008010	M8 x 10	-	5	100	3.000
T738004025	M4 x 25	-	2.5	500	8.000	T738008012	M8 x 12	-	5	100	2.400
T738004030	M4 x 30	-	2.5	500	6.000	T738008016	M8 x 16	-	-	100	2.400
T738004040	M4 x 40	-	2.5	250	6.000	T738008020	M8 x 20	-	5	100	2.400
T738005010	M5 x 10	-	3	500	8.000	T738008025	M8 x 25	-	5	100	1.600
T738005012	M5 x 12	-	3	250	6.000	T738008030	M8 x 30	-	5	100	1.600
T738005014	M5 x 14	-	3	250	-	T738008035	M8 x 35	-	5	100	1.200
T738005016	M5 x 16	-	3	250	6.000	T738008040	M8 x 40	-	5	100	1.200
T738005020	M5 x 20	-	3	250	6.000	T738008045	M8 x 45	-	5	100	1.200
T738005025	M5 x 25	-	3	250	6.000	T738008050	M8 x 50	-	-	100	1.200
T738005030	M5 x 30	-	3	250	4.000	T738008060	M8 x 60	-	-	100	800
T738005035	M5 x 35	-	3	250	3.000	T738010016	M10 x 16	-	6	100	1.600
T738005040	M5 x 40	-	3	250	3.000	T738010020	M10 x 20	-	6	100	-
T738005050	M5 x 50	-	3	250	2.000	T738010025	M10 x 25	-	6	100	1.200
T738006008	M6 x 8	-	4	250	7.500	T738010030	M10 x 30	-	6	100	800
T738006010	M6 x 10	-	4	250	6.000	T738010035	M10 x 35	-	-	100	800
T738006012	M6 x 12	-	4	250	6.000	T738010040	M10 x 40	-	6	100	800
T738006016	M6 x 16	-	4	250	6.000	T738010045	M10 x 45	-	6	100	600
T738006020	M6 x 20	-	4	250	4.000	T738010050	M10 x 50	-	6	100	600
T738006025	M6 x 25	-	4	250	3.000	T738010060	M10 x 60	-	-	100	600



BROCAS, PUNTAS Y ACCESORIOS



PUN

Puntas de atornillar



PU-PH

PH



CÓDIGO	MEDIDA	€/100			
PUPHC01	PH1	73,543	PH1	25	1.125
PUPHL01	PH1	117,973	PH1	25	1.125
PUPHC02	PH2	73,543	PH2	25	1.125
PUPHL02	PH2	117,973	PH2	25	1.125
PUPHC03	PH3	73,543	PH3	25	1.125
PUPHL03	PH3	117,973	PH3	25	1.125

 Blíster



CÓDIGO	MEDIDA	€/BOLSA	PCS 	BOLSAS 
BZPUPHCL01	PH1	3,377	4	20
BZPUPHCL02	PH2	3,377	4	20
BZPUPHCL03	PH3	3,377	4	20

METAL



PU-TO

TX



CÓDIGO	MEDIDA	€/100			
PUT0010	T10	82,853	TX10	25	1.125
PUT0015	T15	82,853	TX15	25	1.125
PUT0020	T20	82,853	TX20	25	1.125
PUT0025	T25	82,853	TX25	25	1.125
PUT0030	T30	82,853	TX30	25	1.125
PUT0040	T40	82,853	TX40	25	1.125

 Blíster



CÓDIGO	MEDIDA	€/BOLSA	PCS 	BOLSAS 
BZPUTOT01	T10+T20	3,377	2	20
BZPUTOT02	T30+T40	3,377	2	20

METAL

PU-OX

OXBIT



CÓDIGO	MEDIDA	€/100			
PUOXBITC10	OXB-10	99,433	OXB-10	25	1.125
PUOXBITL10	OXB-10	159,000	OXB-10	25	1.125
PUOXBITC15	OXB-15	99,433	OXB-15	25	1.125
PUOXBITL15	OXB-15	159,000	OXB-15	25	1.125
PUOXBITC20	OXB-20	99,433	OXB-20	25	1.125
PUOXBITL20	OXB-20	159,000	OXB-20	25	1.125
PUOXBITC25	OXB-25	99,433	OXB-25	25	1.125
PUOXBITL25	OXB-25	159,000	OXB-25	25	1.125
PUOXBITC30	OXB-30	99,433	OXB-30	25	1.125
PUOXBITL30	OXB-30	159,000	OXB-30	25	1.125
PUOXBITC40	OXB-40	99,433	OXB-40	25	1.125
PUOXBITL40	OXB-40	159,000	OXB-40	25	1.125

METAL



CARACTERÍSTICAS

Ajuste perfecto en tornillo:

Garantizan que el tornillo quede totalmente fijado en la punta, permitiendo una instalación ergonómica en cualquier posición y mejorando el guiado del tornillo.

Transmisión óptima de la fuerza:

Aseguran un asiento perfecto en la mortaja y aumentan la superficie de apriete, optimizando la transmisión del par de apriete.

Anti Cam-Out:

Las puntas OXBIT reducen el efecto "Cam-Out" que en el caso de trabajos con máquina son especialmente altas y pueden provocar un deslizamiento de la punta saliéndose de la mortaja del tornillo. Esto aumenta la vida útil de las puntas y de las mortajas.

Ideal para aplicaciones de altas prestaciones:

Especialmente diseñadas para garantizar la transmisión en trabajos con pares altos, soportan altas velocidades y el par de los atornilladores de impacto.

Menor esfuerzo:

Aumentan la transmisión del par de apriete, permitiendo la instalación con un menor esfuerzo, incluso con pares de apriete elevados.

Aumento de la vida útil de la punta:

Gracias al diseño de las puntas OXBIT y al ajuste perfecto con la mortaja, permiten alargar la vida útil de las puntas y de las mortajas.



Puntas de atornillar

PUN

METAL

PU-PO

PZ

CÓDIGO	MEDIDA	€/100			
PUPOC01	PZ1	73,543	PZ1	25	1.125
PUPOL01	PZ1	117,973	PZ1	25	1.125
PUPOC02	PZ2	73,543	PZ2	25	1.125
PUPOL02	PZ2	117,973	PZ2	25	1.125
PUPOC03	PZ3	73,543	PZ3	25	1.125
PUPOL03	PZ3	117,973	PZ3	25	1.125



Blíster

CÓDIGO	MEDIDA	€/BOLSA	PCS BOLSA	BOLSAS
BZPUPOCL01	PZ1	3,377	4	20
BZPUPOCL02	PZ2	3,377	4	20
BZPUPOCL03	PZ3	3,377	4	20

METAL

PU-CU

Cuadrada

CÓDIGO	MEDIDA	€/100			
PUCUC01	PC1	73,543	PC1	25	1.125
PUCUL01	PC1	117,973	PC1	25	1.125
PUCUC02	PC2	73,543	PC2	25	1.125
PUCUL02	PC2	117,973	PC2	25	1.125
PUCUC03	PC3	73,543	PC3	25	1.125
PUCUL03	PC3	117,973	PC3	25	1.125



Bocas hexagonales magnéticas

BOCA

METAL

CÓDIGO	MEDIDA	€/100	LLAVE DE INSTALACIÓN		
BOCA006	6 mm.	426,000	1/4"	5	225
BOCA007	7 mm.	426,000	1/4"	5	225
BOCA008	8 mm.	426,000	1/4"	5	225
BOCA010	10 mm.	426,000	1/4"	5	225
BOCA013	13 mm.	583,333	1/4"	5	225
BOCA055	5,5 mm.	426,000	1/4"	5	225



Blíster

CÓDIGO	MEDIDA	€/BOLSA	PCS BOLSA	BOLSAS
BZBOCA008	8 mm.	4,597	1	20
BZBOCA010	10 mm.	4,597	1	20

PU-PM

Porta puntas magnético 1/4

METAL

PU-PM

Porta puntas magnético 1/4





CÓDIGO	MEDIDA	€/100		
PUPM014	1/4" x 60	540,410	5	225

NEW PU-PMI

Inoxidable

METAL





CÓDIGO	MEDIDA	€/100	UD. MIN. VENTA		
PUPMI014	1/4" x 60	1.000,000	5	5	225

ATAP

Tapón de nylon de colores para tornillos con cabeza hexagonal

METAL



CÓDIGO	COLOR	€/100			
ATAPO08AR	RAL 1001	7,557	8	1.000	2.000
ATAPO08BO	RAL 9002	7,557	8	1.000	2.000
ATAPO08BP	RAL 9010	7,557	8	1.000	2.000
ATAPO08BS	RAL 9003	7,557	8	1.000	2.000
ATAPO08GM	RAL 9006	7,557	8	1.000	2.000
ATAPO08NE	RAL 9005	7,557	8	1.000	2.000
ATAPO08PC	RAL 8004	7,557	8	1.000	2.000
ATAPO08RC	RAL 3003	7,557	8	1.000	2.000
ATAPO08RT	RAL 3011	7,557	8	1.000	2.000
ATAPO08RX	RAL 3009	7,557	8	1.000	2.000
ATAPO08VN	RAL 6028	7,557	8	1.000	2.000
ATAPO10AR	RAL 1001	7,557	10	1.000	2.000
ATAPO10BO	RAL 9002	7,557	10	1.000	2.000
ATAPO10BP	RAL 9010	7,557	10	1.000	2.000
ATAPO10BS	RAL 9003	7,557	10	1.000	2.000
ATAPO10GM	RAL 9006	7,557	10	1.000	2.000
ATAPO10NE	RAL 9005	7,557	10	1.000	2.000
ATAPO10PC	RAL 8004	7,557	10	1.000	2.000
ATAPO10RC	RAL 3003	7,557	10	1.000	2.000
ATAPO10RT	RAL 3011	7,557	10	1.000	2.000
ATAPO10RX	RAL 3009	7,557	10	1.000	2.000
ATAPO10VN	RAL 6028	7,557	10	1.000	2.000

Tapones de PVC para tornillos DIN-7504-N y DIN-7981



TP-CR

METAL



TP-CR B

Blanco

CÓDIGO	MEDIDA	€/100		
TPCR042BL	Ø4,2	3,757	1.000	12.000
TPCR048BL	Ø4,8	3,757	1.000	12.000
TPCR055BL	Ø5,5	3,757	1.000	6.000





METAL



TP-CR N

Negro

CÓDIGO	MEDIDA	€/100		
TPCR042NE	Ø4,2	3,757	1.000	12.000
TPCR048NE	Ø4,8	3,757	1.000	12.000
TPCR055NE	Ø5,5	3,757	1.000	6.000





Tapones adhesivos de colores tapa-tornillo

TP-TP



MADERA



CÓDIGO	DIÁMETRO	COLOR	€/100		
TPTPADBE	14	BEIGE	3,710	1.000	24.000
TPTPADBL	14	BLANCO	3,710	1.000	24.000
TPTPADCA	14	CAOBA	3,710	1.000	24.000
TPTPADCE	14	CEREZO	3,710	1.000	24.000
TPTPADGR	14	GRIS	3,710	1.000	24.000
TPTPADHA	14	HAYA	3,710	1.000	24.000
TPTPADNE	14	NEGRO	3,710	1.000	24.000
TPTPADNO	14	NOGAL	3,710	1.000	24.000
TPTPADPI	14	PINO	3,710	1.000	24.000
TPTPADRO	14	ROBLE	3,710	1.000	24.000
TPTPADSA	14	SAPELLY	3,710	1.000	24.000





















 Blíster



















CÓDIGO	MEDIDA	€/BOLSA	PCS 	BOLSAS 
BZTTPADBE	BEIGE	2,040	20	25
BZTTPADBL	BLANCO/WHITE/BLANC	2,040	20	25
BZTTPADCA	CAOBA/MAHOGANY/ACAJOU	2,040	20	25
BZTTPADCE	CEREZO/CHERRY/CERISIER	2,040	20	25
BZTTPADGR	GRIS/GREY/GRIS	2,040	20	25
BZTTPADHA	HAYA/BEECH/HETRE	2,040	20	25
BZTTPADNE	NEGRO/BLACK/NOIR	2,040	20	25
BZTTPADNO	NOGAL/WALNUT/NOYER	2,040	20	25
BZTTPADPI	PINO/PINE/PIN	2,040	20	25
BZTTPADRO	ROBLE/OAK/CHÊNE	2,040	20	25
BZTTPADSA	SAPELLY	2,040	20	25



ABRAZADERAS METÁLICAS PESADAS



	MEDIDAS (mm)	CARGA RECOMENDADA kg	RECUBRIMIENTO	ESPESOR (mm)	ANCHURA (mm)	APERTURA	MANGUITO	HOMOLOGACIÓN	ISOFÓNICA	CTE
AB-RA	APLICACIONES: Saneamiento Eléctrico									P. 252
	Ø 15 - Ø 125	80		1,5	20	Rápida lateral	M8	-	-	-
AB-IA	APLICACIONES: ACS y AF, Gas, Saneamiento, Calefacción, Climatización, Eléctrico, Ventilación									P. 252
	Ø 15 - Ø 125	80		1,5	20	Rápida lateral	M8	-	✓	✓
AB-IR	APLICACIONES: ACS y AF, Gas, Saneamiento, Calefacción, Climatización, Eléctrico, Ventilación									P. 252
	Ø 15 - Ø 60	60		1,25	19	Rápida vertical	M8	-	✓	✓
AB-RE AB-RE V	APLICACIONES: Saneamiento, Eléctrico, Ventilación									P. 253
	Ø 18 - Ø 1250	150 - 200		1,8 - 2,3	19	Tornillo	M8 / M10	-	-	-
AB-RI AB-RI V	APLICACIONES: ACS y AF, Gas, Saneamiento, Calefacción, Climatización, Eléctrico, Ventilación									P. 254/ 255
	Ø 18 - Ø 1250	150 - 200		1,8 - 2,3	19	Tornillo	M8 / M10	-	✓	✓
AB-RE A2 AB-RE A4	APLICACIONES: ACS y AF, Gas, Saneamiento, Calefacción, Climatización, Eléctrico, Ventilación									P. 253/ 254
	Ø 18 - Ø 1250	150 - 200	  AB-RE A2 AB-RE A4	1,8 - 2,3	19	Tornillo	M8 / M10	-	✓	✓
AB-RI A2 AB-RI A4	APLICACIONES: ACS y AF, Gas, Saneamiento, Calefacción, Climatización, Eléctrico, Ventilación									P. 255
	Ø 18 - Ø 1250	150 - 200	  AB-RI A2 AB-RI A4	1,8 - 2,3	19	Tornillo	M8 / M10	-	✓	✓
AB-RI DES	APLICACIONES: Saneamiento, Eléctrico									P. 256
	Ø 16 - Ø 160	150		1,2 - 2,0	20	Rápida lateral	M8 / M10	-	✓	✓

	MEDIDAS (mm)	CARGA RECOMENDADA (kg)	RECUBRIMIENTO	ESPESOR (mm)	ANCHURA (mm)	APERTURA	MANGUITO	HOMOLOGACIÓN	ISOFÓNICA	CTE <small>CONFORME CON LA NORMATIVA</small>	
AB-ICP	APLICACIONES: ACS y AF, Gas, Saneamiento, Calefacción, Climatización, Eléctrico, Ventilación										P. 256
	Ø 60 - Ø 135	200		2,75 - 4,0	30 - 40	Tornillo	M8 / M10 M10 / M12 M12 / M16	-			
AB-AIS	APLICACIONES: ACS y AF, Gas, Saneamiento, Calefacción, Climatización, Eléctrico, Ventilación										P. 257
	Ø 10 - Ø 219	150 - 200		13 - 40	20 - 40	AB-AIS Rápida lateral 13 & 19 AB-AIS Tornillo 30 & 40	M8 / M10 M8 / M10 M12 / M16	-			
AB-GA	APLICACIONES: Gas										P. 258
	Ø 18 - Ø 160	150 - 200		2	19	Tornillo	M8 ≤ Ø54 M8 / M10 > Ø54	De acuerdo a UNE-EN ISO 4892	-	-	
AB-M8	APLICACIONES: Saneamiento, Desagüe										P. 258
	Ø 50 - Ø 315	100		1	28	Tornillo	M8	-	-	-	
AB-ZI	APLICACIONES: Gas, Saneamiento										P. 258
	Ø 16 - Ø 230	250 - 350		M6 - M8 - M10	-	-	-	-	-	-	
AB-SA	APLICACIONES: Gas, Saneamiento										P. 259
	-	-		5 - 6	-	-	-	-	-	-	
AB-GP	APLICACIONES: Saneamiento, Industrial										P. 259
	Ø 25 - Ø 235	-		0,6 - 1,8	18 - 25	Tornillo	-	-	-	-	

AB-RA

Abrazadera reforzada M8 abierta

02 Info. Técnica
P. 412

SANEAMIENTO



CÓDIGO	MEDIDA	ØD(MM)	€/100	CARGA MÁXIMA		
ABRA015	15 (M8)	12-16	83,611	80	50	300
ABRA018	18 (M8)	15 - 19	85,567	80	50	300
ABRA022	22 (M8)	20 - 25	91,230	80	50	200
ABRA028	28 (M8)	26 - 30	96,853	80	50	200
ABRA035	35 (M8)	32 - 36	101,958	80	50	150
ABRA042	42 (M8)	38 - 43	111,573	80	50	150
ABRA048	48 (M8)	47 - 51	122,989	80	50	100
ABRA054	54 (M8)	53 - 58	132,837	80	25	100
ABRA060	60 (M8)	60 - 64	138,013	80	25	75
ABRA075	75 (M8)	75 - 80	156,344	80	25	50
ABRA090	90 (M8)	87 - 92	161,442	80	25	50
ABRA100	100 (M8)	99 - 105	178,070	80	25	50
ABRA110	110 (M8)	107 - 112	191,317	80	25	50
ABRA115	115 (M8)	113 - 118	213,425	80	25	50
ABRA125	125 (M8)	125 - 130	221,321	80	25	50

AB-IA

Abrazadera reforzada isofónica M8 abierta

02 Info. Técnica
P. 412

SANEAMIENTO



CÓDIGO	MEDIDA	ØD(MM)	€/100	CARGA MÁXIMA		
ABIA015	15 (M8)	12-16	99,229	80	50	200
ABIA018	18 (M8)	15 - 19	101,767	80	50	200
ABIA022	22 (M8)	20 - 25	110,525	80	50	150
ABIA028	28 (M8)	26 - 30	117,850	80	50	100
ABIA035	35 (M8)	32 - 36	126,042	80	50	100
ABIA042	42 (M8)	38 - 43	143,082	80	50	-
ABIA048	48 (M8)	47 - 51	152,777	80	50	-
ABIA054	54 (M8)	53 - 58	166,184	80	25	50
ABIA060	60 (M8)	60 - 64	176,356	80	25	50
ABIA075	75 (M8)	75 - 80	199,200	80	25	50
ABIA090	90 (M8)	87 - 92	217,696	80	25	50
ABIA100	100 (M8)	99 - 105	252,274	80	25	50
ABIA110	110 (M8)	107 - 112	265,193	80	25	-
ABIA115	115 (M8)	113 - 118	295,822	80	25	-
ABIA125	125 (M8)	125 - 130	304,824	80	25	-

AB-IR

Abrazadera isofónica M8 instalación rápida

02 Info. Técnica
P. 412

SANEAMIENTO



CÓDIGO	MEDIDA	ØD(MM)	€/100	MEDIDA EN PULGADAS	CARGA MÁXIMA		
ABIR015	15 (M8)	14 - 15	87,655	M8	60	50	300
ABIR018	18 (M8)	16 - 19	93,735	M8	60	50	300
ABIR022	22 (M8)	21 - 23	98,802	M8	60	50	200
ABIR028	28 (M8)	26 - 28	107,965	M8	60	50	150
ABIR035	35 (M8)	32 - 35	120,765	M8	60	50	100
ABIR040	40 (M8)	40 - 43	136,242	M8	60	25	100
ABIR048	48 (M8)	48 - 51	150,872	M8	60	25	100
ABIR054	54 (M8)	52 - 56	157,355	M8	60	25	75
ABIR060	60 (M8)	57 - 60	165,220	M8	60	25	75

Abrazadera reforzada M8 + M10

AB-RE



02 Info
P. 413 Técnica

SANEAMIENTO



AB-RE

Zincada

CÓDIGO	MEDIDA	ØD(MM)	€/100	CARGA MÁXIMA		
ABRE018	18 (M8+M10)	15 - 19	108,313	80	50	300
ABRE022	22 (M8+M10)	20 - 25	112,630	80	50	200
ABRE028	28 (M8+M10)	26 - 30	122,599	80	50	150
ABRE035	35 (M8+M10)	32 - 36	129,061	80	50	100
ABRE040	40 (M8+M10)	38 - 43	139,467	80	25	100
ABRE048	48 (M8+M10)	47 - 51	153,737	80	25	100
ABRE054	54 (M8+M10)	53 - 56	163,997	80	25	75
ABRE060	60 (M8+M10)	60 - 64	168,308	80	25	75
ABRE070	70 (M8+M10)	68 - 72	181,377	80	25	50
ABRE075	75 (M8+M10)	75 - 80	186,123	150	25	50
ABRE083	83 (M8+M10)	81 - 86	190,277	150	25	-
ABRE090	90 (M8+M10)	87 - 92	196,880	150	25	-
ABRE100	100 (M8+M10)	99 - 105	217,159	150	25	-
ABRE110	110 (M8+M10)	107 - 112	233,314	150	25	-
ABRE115	115 (M8+M10)	113 - 118	260,274	200	25	-
ABRE125	125 (M8+M10)	125 - 130	269,904	200	25	-
ABRE133	133 (M8+M10)	132 - 137	307,700	200	25	-
ABRE140	140 (M8+M10)	138 - 142	334,617	200	25	-
ABRE150	150 (M8+M10)	148 - 152	336,679	200	25	-
ABRE160	160 (M8+M10)	159 - 166	356,928	200	25	-
ABRE180	180 (M8+M10)	179 - 184	413,061	200	25	-
ABRE200	200 (M8+M10)	199 - 212	449,244	200	25	-
ABRE220	220 (M8+M10)	215 - 226	488,817	200	25	-
ABRE250	250 (M8+M10)	245 - 254	567,453	200	25	-
ABRE280	280 (M8+M10)	278 - 284	648,289	200	25	-
ABRE300	300 (M8+M10)	299 - 304	729,124	200	25	-
ABRE315	315 (M8+M10)	314 - 319	819,980	200	25	-
ABRE355	355 (M8+M10)	354 - 359	1.039,097	200	25	-



02 Info
P. 413 Técnica

SANEAMIENTO



AB-RE V

Zincada. Ventilación

CÓDIGO	MEDIDA	ØD(MM)	€/100	CARGA MÁXIMA	
ABRE400	400 (M8+M10)	399 - 404	1.203,173	200	25
ABRE450	450 (M8+M10)	449 - 454	1.467,213	200	10
ABRE500	500 (M8+M10)	499 - 504	1.473,424	200	10
ABRE560	560 (M8+M10)	555 - 561	1.727,242	200	10
ABRE600	600 (M8+M10)	599 - 604	1.838,294	200	10
ABRE630	630 (M8+M10)	625 - 631	2.006,924	200	10
ABRE710	710 (M8+M10)	705 - 711	2.262,498	200	10
ABRE800	800 (M8+M10)	799 - 804	2.503,142	200	10
ABRE900	900 (M8+M10)	899 - 904	2.774,952	200	10
ABRE910	1000 (M8+M10)	999 - 1.004	3.108,835	200	10
ABRE911	1120 (M8+M10)	1.115 - 1.121	3.403,800	200	10
ABRE912	1250 (M8+M10)	1.245 - 1.251	3.738,284	200	10



02 Info
P. 414 Técnica

INOXIDABLE



AB-RE A2

Inoxidable A2

CÓDIGO	MEDIDA	ØD(MM)	€/100	CARGA MÁXIMA		
ABREA2018	18 (M8+M10)	15 - 18	381,133	150	50	300
ABREA2022	22 (M8+M10)	20 - 24	392,963	150	50	200
ABREA2028	28 (M8+M10)	26 - 30	443,166	150	50	150
ABREA2035	35 (M8+M10)	32 - 36	461,445	150	50	100
ABREA2040	40 (M8+M10)	36 - 42	487,376	150	25	100
ABREA2048	48 (M8+M10)	47 - 50	514,040	150	25	100
ABREA2054	54 (M8+M10)	51 - 55	542,877	150	25	75
ABREA2060	60 (M8+M10)	60 - 64	560,050	150	25	75
ABREA2075	75 (M8+M10)	75 - 80	623,047	150	25	50
ABREA2090	90 (M8+M10)	87 - 92	666,692	150	25	-
ABREA2110	110 (M8+M10)	106 - 112	736,779	150	25	-
ABREA2115	115 (M8+M10)	114 - 119	784,717	150	25	-
ABREA2125	125 (M8+M10)	124 - 131	824,328	150	25	-
ABREA2140	140 (M8+M10)	133 - 140	988,740	150	25	-
ABREA2160	160 (M8+M10)	159 - 163	1.083,740	150	25	-
ABREA2200	200 (M8+M10)	199 - 212	1.449,991	150	25	-



AB-RE

Abrazadera reforzada M8 + M10

AB-RE A4

Inoxidable A4

02 Info. Técnica
P. 414

INOXIDABLE



CÓDIGO	MEDIDA	ØD(MM)	€/100	CARGA MÁXIMA		
ABREA4018	18 (M8+M10)	15 - 18	461,382	150	50	300
ABREA4022	22 (M8+M10)	20 - 24	473,873	150	50	200
ABREA4028	28 (M8+M10)	26 - 30	506,095	150	50	150
ABREA4035	35 (M8+M10)	32 - 36	559,794	150	50	100
ABREA4040	40 (M8+M10)	36 - 42	583,804	150	25	100
ABREA4048	48 (M8+M10)	47 - 50	648,745	150	25	100
ABREA4054	54 (M8+M10)	51 - 55	676,822	150	25	75
ABREA4060	60 (M8+M10)	60 - 64	701,442	150	25	75
ABREA4075	75 (M8+M10)	75 - 80	800,485	150	25	50
ABREA4090	90 (M8+M10)	87 - 92	829,012	150	25	-
ABREA4110	110 (M8+M10)	106 - 112	973,250	150	25	-
ABREA4115	115 (M8+M10)	114 - 119	1.044,142	150	25	-
ABREA4125	125 (M8+M10)	124 - 131	1.088,679	150	25	-
ABREA4140	140 (M8+M10)	133 - 140	1.338,383	150	25	-
ABREA4160	160 (M8+M10)	159 - 163	1.428,322	150	25	-
ABREA4200	200 (M8+M10)	199 - 212	1.714,167	150	25	-

AB-RI

Abrazadera isofónica reforzada M8 + M10

AB-RI

Zincada

02 Info. Técnica
P. 413

SANEAMIENTO



CÓDIGO	MEDIDA	ØD(MM)	€/100	CARGA MÁXIMA		
ABRI018	18 (M8+M10)	15 - 19	124,107	80	50	200
ABRI022	22 (M8+M10)	20 - 25	134,787	80	50	150
ABRI028	28 (M8+M10)	26 - 30	143,720	80	50	150
ABRI035	35 (M8+M10)	32 - 36	153,710	80	50	100
ABRI040	40 (M8+M10)	38 - 43	174,490	80	25	75
ABRI048	48 (M8+M10)	47 - 51	186,313	80	25	75
ABRI054	54 (M8+M10)	53 - 56	202,663	80	25	50
ABRI060	60 (M8+M10)	60 - 64	215,069	80	25	50
ABRI070	70 (M8+M10)	68 - 72	234,357	80	25	-
ABRI075	75 (M8+M10)	75 - 80	242,927	150	25	-
ABRI083	83 (M8+M10)	81 - 86	266,647	150	25	-
ABRI090	90 (M8+M10)	87 - 92	265,483	150	25	-
ABRI100	100 (M8+M10)	99 - 105	307,651	150	25	-
ABRI110	110 (M8+M10)	107 - 112	323,407	150	25	-
ABRI115	115 (M8+M10)	113 - 118	360,759	200	25	-
ABRI125	125 (M8+M10)	125 - 130	371,737	200	25	-
ABRI133	133 (M8+M10)	132 - 137	407,990	200	25	-
ABRI140	140 (M8+M10)	138 - 142	436,817	200	25	-
ABRI150	150 (M8+M10)	148 - 152	446,467	200	25	-
ABRI160	160 (M8+M10)	159 - 166	482,517	200	25	-
ABRI180	180 (M8+M10)	179 - 184	555,907	200	25	-
ABRI200	200 (M8+M10)	196 - 203	615,721	200	25	-
ABRI220	220 (M8+M10)	215 - 226	674,807	200	25	-
ABRI250	250 (M8+M10)	245 - 254	743,757	200	25	-
ABRI280	280 (M8+M10)	278 - 284	849,585	200	25	-
ABRI300	300 (M8+M10)	299 - 304	904,413	200	25	-
ABRI315	315 (M8+M10)	314 - 319	1.006,933	200	25	-
ABRI355	355 (M8+M10)	354 - 359	1.416,279	200	25	-

Abrazadera reforzada M8 + M10

AB-RE

 Info Técnica
P. 613

SANEAMIENTO



CÓDIGO	MEDIDA	ØD(MM)	€/100	CARGA MÁXIMA	
ABRI400	400 (M8+M10)	399 - 404	1.521,835	200	25
ABRI450	450 (M8+M10)	449 - 454	1.851,179	200	10
ABRI500	500 (M8+M10)	499 - 504	1.899,788	200	10
ABRI560	560 (M8+M10)	555 - 561	2.108,473	200	10
ABRI600	600 (M8+M10)	599 - 604	2.279,002	200	10
ABRI630	630 (M8+M10)	625 - 631	2.424,033	200	10
ABRI710	710 (M8+M10)	705 - 711	2.926,004	200	10
ABRI800	800 (M8+M10)	799 - 804	3.179,462	200	10
ABRI900	900 (M8+M10)	899 - 904	3.609,140	200	10
ABRI910	1000 (M8+M10)	999 - 1.004	3.990,690	200	10
ABRI911	1120 (M8+M10)	1.115 - 1.121	4.408,712	200	10
ABRI912	1250 (M8+M10)	1.245 - 1.251	4.924,982	200	10

AB-RI V

Zincada. Ventilación



 Info Técnica
P. 614

INOXIDABLE



CÓDIGO	MEDIDA	ØD(MM)	€/100	CARGA MÁXIMA		
ABRIA2018	18 (M8+M10)	15 - 18	451,652	150	50	200
ABRIA2022	22 (M8+M10)	20 - 24	464,112	150	50	150
ABRIA2028	28 (M8+M10)	26 - 30	484,763	150	50	150
ABRIA2035	35 (M8+M10)	32 - 36	510,016	150	50	100
ABRIA2040	40 (M8+M10)	36 - 42	560,523	150	25	75
ABRIA2048	48 (M8+M10)	47 - 50	594,062	150	25	75
ABRIA2054	54 (M8+M10)	51 - 55	640,098	150	25	50
ABRIA2060	60 (M8+M10)	60 - 64	674,848	150	25	50
ABRIA2075	75 (M8+M10)	75 - 80	760,267	150	25	-
ABRIA2090	90 (M8+M10)	87 - 92	799,166	150	25	-
ABRIA2110	110 (M8+M10)	106 - 112	902,767	150	25	-
ABRIA2115	115 (M8+M10)	114 - 119	894,469	150	25	-
ABRIA2125	125 (M8+M10)	124 - 131	991,594	150	25	-
ABRIA2140	140 (M8+M10)	133 - 140	1.057,113	150	25	-
ABRIA2160	160 (M8+M10)	159 - 163	1.149,961	150	25	-

AB-RI A2

Inoxidable A2



 Info Técnica
P. 614

INOXIDABLE



CÓDIGO	MEDIDA	ØD(MM)	€/100	CARGA MÁXIMA		
ABRIA4018	18 (M8+M10)	15 - 18	572,529	150	50	200
ABRIA4022	22 (M8+M10)	20 - 24	601,895	150	50	150
ABRIA4028	28 (M8+M10)	26 - 30	625,189	150	50	150
ABRIA4035	35 (M8+M10)	32 - 36	675,318	150	50	100
ABRIA4040	40 (M8+M10)	36 - 42	720,756	150	25	75
ABRIA4048	48 (M8+M10)	47 - 50	782,568	150	25	75
ABRIA4054	54 (M8+M10)	51 - 55	829,332	150	25	50
ABRIA4060	60 (M8+M10)	60 - 64	897,729	150	25	50
ABRIA4075	75 (M8+M10)	75 - 80	972,580	150	25	-
ABRIA4090	90 (M8+M10)	87 - 92	1.072,419	150	25	-
ABRIA4110	110 (M8+M10)	106 - 112	1.264,429	150	25	-
ABRIA4115	115 (M8+M10)	114 - 119	1.320,999	150	25	-
ABRIA4125	125 (M8+M10)	124 - 131	1.392,583	150	25	-
ABRIA4140	140 (M8+M10)	133 - 140	1.427,321	150	25	-
ABRIA4160	160 (M8+M10)	159 - 163	1.694,718	150	25	-

AB-RI A4

Inoxidable A4



AB-RI DES

Abrazadera isofónica reforzada deslizante M8+M10



CÓDIGO	MEDIDA	€/100	
ABRID016	16	192,147	150
ABRID020	20	200,150	100
ABRID025	25	212,160	100
ABRID032	32	232,180	100
ABRID040	40	252,190	50
ABRID050	50	335,673	50
ABRID063	63	404,303	50
ABRID075	75	460,350	50
ABRID090	90	508,387	50
ABRID110	110	660,503	25
ABRID125	125	800,607	25
ABRID140	140	848,643	20
ABRID160	160	980,743	20

PA-EX

Patin de expansión



CÓDIGO	MEDIDA	€/100	
PAEXM08	M8 x 180	3.865,435	50
PAEXM10	M10 x 180	3.865,435	50

CO-AR

Colgador articulado



CÓDIGO	MEDIDA	€/100		
COAR08060	M8 x 60	243,227	50	300
COAR10060	M10 x 60	374,200	50	300

AB-ICP

Abrazadera isofónica reforzada para cargas pesadas



CÓDIGO	MEDIDA	ØD(MM)	€/100	MEDIDA EN PULGADAS	
ABICP060	60 (M8+M10)	60 - 64	969,273	(M8+M10)	25
ABICP075	75 (M10+M12)	75 - 80	1.222,077	(M10+M12)	25
ABICP090	90 (M10+M12)	87 - 92	1.333,170	(M10+M12)	25
ABICP110	110 (M10+M12)	107 - 112	1.527,600	(M10+M12)	25
ABICP140	140 (M12+M16)	138 - 142	2.666,357	(M12+M16)	25
ABICP160	160 (M12+M16)	159 - 166	3.069,363	(M12+M16)	25
ABICP220	220 (M12+M16)	215 - 226	4.038,643	(M12+M16)	10
ABICP270	270 (M12+M16)	268 - 274	5.060,080	(M12+M16)	10
ABICP315	315 (M12+M16)	314 - 319	5.738,233	(M12+M16)	10

Abrazadera aislante térmica

AB-AIS



AB-AIS 13

13 mm



CÓDIGO	MEDIDA	€/100	ESPEJOR AISLANTE (MM)	
ABAI513010	Ø10	895,627	13	50
ABAI513012	Ø12	918,590	13	50
ABAI513015	Ø15	941,553	13	50
ABAI513018	Ø18	1.010,450	13	50
ABAI513022	Ø22	1.079,343	13	50
ABAI513028	Ø28	1.125,270	13	50



AB-AIS 19

19 mm



CÓDIGO	MEDIDA	€/100	ESPEJOR AISLANTE (MM)	
ABAI519010	Ø10	1.102,307	19	50
ABAI519012	Ø12	1.125,270	19	50
ABAI519015	Ø15	1.194,170	19	50
ABAI519017	Ø17	1.194,170	19	50
ABAI519018	Ø18	1.217,130	19	50
ABAI519022	Ø22	1.240,093	19	50
ABAI519028	Ø28	1.331,953	19	50
ABAI519035	Ø35	1.423,810	19	50
ABAI519042	Ø42	1.538,640	19	25
ABAI519054	Ø54	1.745,323	19	25
ABAI519060	Ø60	2.020,898	19	25
ABAI519064	Ø64	2.213,365	19	25
ABAI519067	Ø67	2.357,714	19	25
ABAI519076	Ø76	2.526,121	19	25
ABAI519080	Ø80	2.646,409	19	25
ABAI519114	Ø114	3.608,741	19	10



AB-AIS 30

30 mm



CÓDIGO	MEDIDA	€/100	ESPEJOR AISLANTE (MM)	
ABAI530027	Ø27	1.676,427	30	50
ABAI530034	Ø34	1.814,213	30	50
ABAI530042	Ø42	1.929,040	30	25
ABAI530049	Ø49	2.093,073	30	25
ABAI530054	Ø54	2.411,297	30	25
ABAI530060	Ø60	2.574,242	30	25
ABAI530076	Ø76	3.184,445	30	25
ABAI530089	Ø89	3.383,467	30	25
ABAI530108	Ø108	4.510,929	30	10
ABAI530114	Ø114	4.833,530	30	10



AB-AIS 40

40 mm



CÓDIGO	MEDIDA	€/100	ESPEJOR AISLANTE (MM)	
ABAI540049	Ø49	2.503,153	40	25
ABAI540060	Ø60	3.219,437	40	25
ABAI540089	Ø89	4.378,608	40	25
ABAI540114	Ø114	6.036,442	40	10
ABAI540133	Ø133	6.514,332	40	10
ABAI540140	Ø140	7.042,516	40	10
ABAI540159	Ø159	8.048,593	40	10
ABAI540168	Ø168	8.551,630	40	10
ABAI540219	Ø219	10.312,257	40	5

AB-GA

Abrazadera gásmica M8 + M10 amarilla



02 Info. Técnica
P. 415

SANEAMIENTO



CÓDIGO	MEDIDA	ØD(MM)	€/100	MEDIDA EN PULGADAS	CARGA MÁXIMA		
ABGA018	18 (M8)	15 - 18	109,181	M8	200	50	300
ABGA022	22 (M8)	20 - 24	112,424	M8	200	50	200
ABGA028	28 (M8)	26 - 30	119,532	M8	200	50	150
ABGA035	35 (M8)	32 - 36	129,366	M8	200	50	100
ABGA040	40 (M8)	38 - 42	134,804	M8	200	50	100
ABGA048	48 (M8)	47 - 50	142,291	M8	200	50	100
ABGA054	54 (M8)	52 - 56	151,516	M8	200	25	75
ABGA060	60 (M8/M10)	60 - 64	163,653	M8/M10	200	25	75
ABGA075	75 (M8/M10)	75 - 80	194,657	M8/M10	200	25	50
ABGA090	90 (M8/M10)	85 - 90	205,708	M8/M10	200	25	-
ABGA100	100 (M8/M10)	99 - 105	223,913	M8/M10	200	25	-
ABGA110	110 (M8/M10)	107 - 112	253,583	M8/M10	200	25	-
ABGA115	115 (M8/M10)	113 - 118	255,808	M8/M10	200	25	-
ABGA140	140 (M8/M10)	138 - 142	305,934	M8/M10	200	25	-
ABGA160	160 (M8/M10)	159 - 166	318,283	M8/M10	200	25	-

AB-M8

Abrazadera desagüe M8



02 Info. Técnica
P. 415

SANEAMIENTO



CÓDIGO	MEDIDA	ØD(MM)	€/100	CARGA MÁXIMA	
ABM8050	50 (M8)	49 - 54	146,253	100	100
ABM8063	63 (M8)	60 - 65	139,340	100	100
ABM8075	75 (M8)	75 - 80	146,867	100	100
ABM8090	90 (M8)	88 - 92	157,063	100	100
ABM8110	110 (M8)	108 - 113	171,850	100	100
ABM8125	125 (M8)	124 - 130	184,093	100	100
ABM8160	160 (M8)	159 - 165	251,007	100	100
ABM8200	200 (M8)	199 - 203	292,053	100	100
ABM8250	250 (M8)	249 - 254	388,487	100	50
ABM8315	315 (M8)	314 - 319	846,490	100	50

AB-ZI

Abarcón

AB-ZI

Zincada



02 Info. Técnica
P. 416

SANEAMIENTO



CÓDIGO	MEDIDA	€/100	CARGA MÁXIMA	Ø VARILLA PULGADAS		
AZIM060250	M6 1/4"	35,025	250	M6	100	800
AZIM060375	M6 3/8"	36,246	250	M6	100	1.200
AZIM060500	M6 1/2"	41,600	250	M6	100	600
AZIM060750	M6 3/4"	49,225	250	M6	100	600
AZIM061000	M6 1"	52,866	250	M6	100	400
AZIM061250	M6 1 1/4"	70,721	250	M6	50	300
AZIM081500	M8 1 1/2"	109,784	350	M8	50	150
AZIM082000	M8 2"	125,138	350	M8	50	150
AZIM082250	M8 2 1/4"	147,254	350	M8	50	100
AZIM082500	M8 2 1/2"	153,571	350	M8	50	100
AZIM083000	M8 3"	164,666	350	M8	50	100
AZIM083500	M8 3 1/2"	196,159	350	M8	50	100
AZIM084000	M8 4"	242,100	350	M8	50	100
AZIM084500	M8 4 1/2"	256,059	350	M8	25	100
AZIM085000	M8 5"	265,016	350	M8	25	100
AZIM086000	M8 6"	301,296	350	M8	25	100
AZIM103000	M10 3"	236,621	350	M10	25	50
AZIM103500	M10 3 1/2"	273,066	350	M10	25	50
AZIM104000	M10 4"	305,159	350	M10	25	100
AZIM105000	M10 5"	338,350	350	M10	25	100
AZIM106000	M10 6"	391,375	350	M10	25	100
AZIM108000	M10 8"	459,104	350	M10	25	100

Abrazadera aislante térmica

AB-AIS

SANEAMIENTO



AB-ZI A2

Inoxidable A2



CÓDIGO	MEDIDA	€/100	CARGA MÁXIMA	Ø VARILLA PULGADAS		
AZA2060500	M6 1/2"	109,780	250	M6	100	600
AZA2060750	M6 3/4"	127,623	250	M6	100	600
AZA2061000	M6 1"	157,233	250	M6	100	400
AZA2061250	M6 1 1/4"	186,167	250	M6	50	300
AZA2081500	M8 1 1/2"	323,520	350	M8	50	150
AZA2082000	M8 2"	376,290	350	M8	50	150
AZA2082500	M8 2 1/2"	423,973	350	M8	50	100
AZA2083000	M8 3"	460,830	350	M8	50	100
AZA2104000	M10 4"	937,600	350	M10	50	-
AZA2106000	M10 6"	1.209,237	350	M10	25	-
AZA2108000	M10 8"	1.446,647	350	M10	25	-

Soporte de abarcón

AB-SA

02 Info. Técnica
P. 416

SANEAMIENTO



CÓDIGO	MEDIDA	€/100	
ABSA050100	50 x 100	642,924	50
ABSA050125	50 x 125	696,783	50
ABSA050200	50 x 200	869,735	25
ABSA050300	50 x 300	1.030,077	25
ABSA050400	50 x 400	1.258,478	25
ABSA050500	50 x 500	1.838,547	10
ABSA050600	50 x 600	2.060,639	10
ABSA100100	100 x 100	881,066	25
ABSA100125	100 x 125	916,244	25
ABSA100200	100 x 200	1.117,190	25
ABSA100300	100 x 300	1.373,463	10
ABSA100400	100 x 400	1.837,104	10
ABSA100500	100 x 500	2.401,347	10



Abrazadera de gran presión

AB-GP

02 Info. Técnica
P. 417

SANEAMIENTO





































CÓDIGO	MEDIDA	ØD(MM)	€/100		
AGP023025	23-25	23 - 25	148,370	50	300
AGP026028	26-28	26 - 28	154,273	50	300
AGP029031	29-31	29 - 31	179,797	50	200
AGP032035	32-35	32 - 35	190,460	50	150
AGP036039	36-39	36 - 39	193,733	50	150
AGP040043	40-43	40 - 43	205,247	50	100
AGP044047	44-47	44 - 47	237,177	50	-
AGP048051	48-51	48 - 51	247,572	25	75
AGP052055	52-55	52 - 55	253,041	25	75
AGP056059	56-59	56 - 59	259,050	25	75
AGP060063	60-63	60 - 63	269,994	25	50
AGP064067	64-67	64 - 67	339,123	25	50
AGP068073	68-73	68 - 73	368,514	25	-
AGP074079	74-79	74 - 79	401,777	25	-
AGP080085	80-85	80 - 85	414,237	25	-
AGP086091	86-91	86 - 91	422,097	25	-
AGP092097	92-97	92 - 97	442,573	25	-
AGP098103	98-103	98 - 103	447,167	25	-
AGP104112	104-112	104 - 112	466,192	25	-
AGP113121	113-121	113 - 121	482,326	25	-
AGP122130	122-130	122 - 130	506,564	25	-
AGP131139	131-139	131 - 139	673,733	25	-
AGP140148	140-148	140 - 148	681,232	25	-
AGP149161	149-161	149 - 161	729,278	25	-
AGP162174	162-174	162 - 174	784,840	25	-





























ABRAZADERAS METÁLICAS LIGERAS



ABRAZADERAS METÁLICAS LIGERAS

MEDIDAS (mm)	CARGA RECOMENDADA kg	RECUBRIMIENTO	ESPESOR (mm)	ANCHURA (mm)	APERTURA	MANGUITO	HOMOLOGACIÓN	ISOFÓNICA	CTE	MONTAJE EN PARALELO	TORNILLO
AB-M6 AB-M6 Z											
APLICACIONES: Gas, Saneamiento, Eléctrico											
P. 264											
	Ø 8 - Ø 63	70 - 100	  AB-M6 AB-M6 Z	1 - 1,2	12	Rápida lateral	Embutida M6	-	-	-	-
AB-M7 Z											
APLICACIONES: Gas Saneamiento Eléctrico											
P. 266											
	Ø 8 - Ø 63	70	 Z	0,8 - 1	11	-	Embutida M7	-	-	-	-
AB-D6 AB-D6 Z											
APLICACIONES: Gas, Saneamiento, Eléctrico											
P. 265											
	Ø 12 - Ø 28	100	  AB-D6 AB-D6 Z	1	12	-	Embutida M6	-	-		-
AB-DZ 7											
APLICACIONES: Gas, Saneamiento, Eléctrico											
P. 266											
	Ø 10 - Ø 28	70	 Z	0,8 - 1	11	-	Embutida M7	-	-		-
AB-6I											
APLICACIONES: ACS y AF, Gas, Saneamiento, Calefacción, Climatización, Eléctrico, Ventilación											
P. 265											
	Ø 12 - Ø 60	70 - 100	 B	1 - 1,2	12	Rápida lateral	Embutida M6	-			-
AB-DI											
APLICACIONES: ACS y AF, Gas, Saneamiento, Calefacción, Climatización, Eléctrico, Ventilación											
P. 265											
	Ø 12 - Ø 60	100	 B	1	12	-	Embutida M6	-			
AB-7I Z											
APLICACIONES: ACS y AF, Gas, Saneamiento, Calefacción, Climatización, Eléctrico, Ventilación											
P. 266											
	Ø 12 - Ø 50	70	 Z	0,8 - 1	11	-	Embutida M7	-			-
AB-7ID Z											
APLICACIONES: ACS y AF, Gas, Saneamiento, Calefacción, Climatización, Eléctrico, Ventilación											
P. 267											
	Ø 10 - Ø 28	70	 Z	0,8 - 1	11	-	Embutida M7	-			
AB-PI											
APLICACIONES: Saneamiento, Eléctrico											
P. 267											
	Ø 6 - Ø 63	30	 Z	1,1 - 1,3	12,5 - 19	-	-	-	-	-	-
AB-PU											
APLICACIONES: Saneamiento, Eléctrico											
P. 267											
	Ø 16 - Ø 63	30	 Z	1,2 - 1,4	12 - 20	-	-	-	-	-	-

ABRAZADERAS METÁLICAS LIGERAS

MEDIDAS (mm)	CARGA RECOMENDADA kg	RECUBRIMIENTO	ESPESOR (mm)	ANCHURA (mm)	APERTURA	MANGUITO	HOMOLOGACIÓN	ISOFÓNICA	CTE	MONTAJE EN PARALELO	TORNILLO	
AB-GM APLICACIONES: Gas P. 272												
	Ø 12 - Ø 35	100		1 - 1,2	12	Rápida lateral	Embutida M6	De acuerdo a UNE-EN ISO 4892	-	-	-	Premontado
AB-GS APLICACIONES: Gas P. 272												
	Ø 10 - Ø 54	70 - 100		1 - 1,2	12	Rápida lateral	Embutida M6	De acuerdo a UNE-EN ISO 4892	-	-	-	Premontado
AB-GD APLICACIONES: Gas P. 272												
	Ø 12 - Ø 28	100		1 - 1,2	12	-	Embutida M6	De acuerdo a UNE-EN ISO 4892	-	-		Premontado
AB-CR APLICACIONES: Saneamiento P. 271												
	Ø 10 - Ø 12	70		1 - 1,2	12	Rápida lateral	Embutida M6	-	-	-	-	-
AB-ITS P. 271												
	15 - 28	-		1,0 - 1,2	20 - 33	-	-	-	-	-	-	-
AB-ITD P. 271												
	15 - 22	-		1,0	20 - 27	-	-	-	-	-	-	-
AB-BU APLICACIONES: Saneamiento, Industrial P. 275												
	Ø 13 - Ø 21	-		0,6	9	-	-	-	-	-	-	Premontado
AB-SF APLICACIONES: Saneamiento, Industrial P. 269												
	Ø 8 - Ø 150	-		0,6 - 0,8	9	-	-	-	-	-	-	Premontado
AB-IP APLICACIONES: ACS y AF, Gas, Saneamiento, Calefacción, Climatización, Eléctrico, Ventilación P. 268												
	-	-		1,5	20	-	-	-			-	ABT006015
AB-SI APLICACIONES: ACS y AF, Gas, Saneamiento, Calefacción, Climatización, Eléctrico, Ventilación P. 268												
	3 / 25 Agujeros	-		3	20	-	-	-				ABT006015

AB-M6

Abrazadera M6

AB-M6

Bicromatada



02 Info. Técnica P. 417

SANEAMIENTO



CÓDIGO	MEDIDA	ØD(MM)	€/100	CARGA MÁXIMA		
ABM6008	8 (M6)	8	19,733	70	100	1.200
ABM6010	10 (M6)	10	19,720	70	100	1.200
ABM6012	12 (M6)	12	19,887	70	100	1.200
ABM6014	14 (M6)	14	20,683	70	100	1.200
ABM6015	15 (M6)	15	20,690	70	100	600
ABM6016	16 (M6)	16	21,487	70	100	600
ABM6018	18 (M6)	18	21,567	70	100	600
ABM6020	20 (M6)	20	22,117	70	100	600
ABM6022	22 (M6)	22	22,883	70	100	600
ABM6025	25 (M6)	25	24,037	70	100	600
ABM6026	26 (M6)	26	24,637	70	100	400
ABM6028	28 (M6)	28	25,363	70	100	400
ABM6032	32 (M6)	32	28,083	70	50	300
ABM6035	35 (M6)	35	31,733	70	50	300
ABM6037	37 (M6)	37	33,480	100	50	300
ABM6040	40 (M6)	40	35,427	100	50	300
ABM6042	42 (M6)	42	36,743	100	50	300
ABM6047	47 (M6)	47	39,953	100	50	200
ABM6050	50 (M6)	50	40,537	100	50	150
ABM6054	54 (M6)	54	46,150	100	50	150
ABM6060	60 (M6)	60	52,660	100	50	150
ABM6063	63 (M6)	63	53,907	100	50	100

AB-M6 Z

Zincada



02 Info. Técnica P. 417

SANEAMIENTO



CÓDIGO	MEDIDA	ØD(MM)	€/100	CARGA MÁXIMA		
ABMZ6008	8 (M6)	8	19,733	70	100	1.200
ABMZ6010	10 (M6)	10	19,720	70	100	1.200
ABMZ6012	12 (M6)	12	19,887	70	100	1.200
ABMZ6014	14 (M6)	14	20,683	70	100	1.200
ABMZ6015	15 (M6)	15	20,690	70	100	600
ABMZ6016	16 (M6)	16	21,487	70	100	600
ABMZ6018	18 (M6)	18	21,567	70	100	600
ABMZ6020	20 (M6)	20	22,117	70	100	600
ABMZ6022	22 (M6)	22	22,883	70	100	600
ABMZ6025	25 (M6)	25	24,037	70	100	600
ABMZ6026	26 (M6)	26	24,637	70	100	400
ABMZ6028	28 (M6)	28	25,363	70	100	400
ABMZ6032	32 (M6)	32	28,083	70	50	300
ABMZ6035	35 (M6)	35	31,733	70	50	300
ABMZ6037	37 (M6)	37	33,480	100	50	300
ABMZ6040	40 (M6)	40	35,427	100	50	300
ABMZ6042	42 (M6)	42	36,743	100	50	300
ABMZ6047	47 (M6)	47	39,953	100	50	200
ABMZ6050	50 (M6)	50	40,537	100	50	150
ABMZ6054	54 (M6)	54	46,150	100	50	150
ABMZ6060	60 (M6)	60	52,660	100	50	150
ABMZ6063	63 (M6)	63	53,907	100	50	100

AB-M6 A2

Inoxidable A2



02 Info. Técnica P. 418

INOXIDABLE



CÓDIGO	MEDIDA	ØD(MM)	€/100	CARGA MÁXIMA		
ABM6A2012	12 (M6)	12	269,863	70	100	1.200
ABM6A2015	15 (M6)	14 - 15	274,740	70	100	600
ABM6A2018	18 (M6)	16 - 18	279,617	70	100	600
ABM6A2020	20 (M6)	19 - 21	285,207	70	100	600
ABM6A2022	22 (M6)	22 - 24	288,820	70	100	600
ABM6A2028	28 (M6)	25 - 30	305,037	70	100	400



Abrazadera doble M6

AB-D6

 Info
Técnica
P. 418

SANEAMIENTO



CÓDIGO	MEDIDA	ØD(MM)	€/100	CARGA MÁXIMA		
ABD6012	12 (M6)	12	30,813	100	50	600
ABD6015	15 (M6)	15	34,253	100	50	300
ABD6018	18 (M6)	18	37,253	100	50	300
ABD6022	22 (M6)	22	42,677	100	50	300
ABD6028	28 (M6)	28	48,517	100	50	200

AB-D6

Bicromatada



 Info
Técnica
P. 418

SANEAMIENTO



CÓDIGO	MEDIDA	ØD(MM)	€/100	CARGA MÁXIMA		
ABDZ6012	12 (M6)	12	30,813	100	50	600
ABDZ6015	15 (M6)	15	34,253	100	50	300
ABDZ6018	18 (M6)	18	37,253	100	50	300
ABDZ6022	22 (M6)	22	42,677	100	50	300
ABDZ6028	28 (M6)	28	48,517	100	50	200

AB-D6 Z

Zincada



Abrazadera isofónica M6

AB-6I

 Info
Técnica
P. 419

SANEAMIENTO



CÓDIGO	MEDIDA	ØD(MM)	€/100	CARGA MÁXIMA		
AB6I012	12 (M6)	12	29,947	70	100	600
AB6I015	15 (M6)	15	31,390	70	100	600
AB6I016	16 (M6)	16	32,783	70	100	600
AB6I018	18 (M6)	18	34,033	70	100	600
AB6I022	22 (M6)	22	37,630	70	100	400
AB6I026	26 (M6)	26	42,031	70	100	400
AB6I028	28 (M6)	28	43,726	70	100	300
AB6I032	32 (M6)	32	48,715	70	50	200
AB6I035	35 (M6)	35	54,424	70	50	200
AB6I042	42 (M6)	42	66,660	100	50	150
AB6I048	48 (M6)	48	74,038	100	50	100
AB6I054	54 (M6)	54	82,402	100	50	100
AB6I060	60 (M6)	60	89,317	100	50	100



Abrazadera doble isofónica M6

AB-DI

 Info
Técnica
P. 419

SANEAMIENTO



CÓDIGO	MEDIDA	ØD(MM)	€/100	CARGA MÁXIMA		
ABDI0012	12 (M6)	12	55,825	100	50	300
ABDI0015	15 (M6)	15	62,147	100	50	300
ABDI0018	18 (M6)	18	69,170	100	50	200
ABDI0022	22 (M6)	22	82,093	100	50	200
ABDI0028	28 (M6)	28	109,218	100	50	150



AB-M7 Z

Abrazadera M7. Zincada



02 Info. Técnica
P. 419

SANEAMIENTO



CÓDIGO	MEDIDA	ØD(MM)	€/100	MEDIDA EN PULGADAS		
ABMZ7008	8	8	19,733	7	100	1.200
ABMZ7010	10	10	19,720	7	100	1.200
ABMZ7012	12	12	19,887	7	100	1.200
ABMZ7014	14	14	20,683	7	100	1.200
ABMZ7016	16	16	21,487	7	100	1.200
ABMZ7018	18	18	21,567	7	100	1.200
ABMZ7020	20	20	22,117	7	100	1.200
ABMZ7022	22	22	22,883	7	100	600
ABMZ7024	24	24	23,827	7	100	600
ABMZ7025	25	25	24,037	7	100	600
ABMZ7026	26	26	24,637	7	100	600
ABMZ7028	28	28	25,363	7	100	600
ABMZ7032	32	32	28,083	7	50	600
ABMZ7034	34	34	31,733	7	50	300
ABMZ7036	36	36	33,480	7	50	300
ABMZ7038	38	38	35,427	7	50	300
ABMZ7040	40	40	36,743	7	50	300
ABMZ7050	50	50	40,537	7	50	200
ABMZ7063	63	63	53,907	7	25	150

AB-D7 Z

Abrazadera doble M7. Zincada



02 Info. Técnica
P. 420

SANEAMIENTO



CÓDIGO	MEDIDA	ØD(MM)	€/100	MEDIDA EN PULGADAS		
ABDZ70810	8-10	8-10	30,813	7	50	600
ABDZ71012	10-12	10-12	30,813	7	50	600
ABDZ71214	12-14	12-14	33,920	7	50	600
ABDZ71416	14-16	14-16	34,253	7	50	600
ABDZ71618	16-18	16-18	37,253	7	50	600
ABDZ71820	18-20	18-20	42,677	7	50	300
ABDZ72022	20-22	20-22	42,677	7	50	300
ABDZ72224	22-24	22-24	51,653	7	50	300
ABDZ72628	26-28	26-28	48,517	7	50	300

AB-7I Z

Abrazadera isofónica M7. Zincada



02 Info. Técnica
P. 420

SANEAMIENTO



CÓDIGO	MEDIDA	ØD(MM)	€/100	MEDIDA EN PULGADAS		
AB7IZ010	10	10	29,103	7	100	1.200
AB7IZ012	12	12	29,947	7	100	1.200
AB7IZ014	14	14	31,390	7	100	1.200
AB7IZ016	16	16	32,783	7	100	1.200
AB7IZ018	18	18	34,033	7	100	600
AB7IZ020	20	20	35,683	7	100	600
AB7IZ022	22	22	37,630	7	100	600
AB7IZ024	24	24	38,843	7	100	600
AB7IZ026	26	26	42,031	7	100	600
AB7IZ028	28	28	43,726	7	100	400
AB7IZ032	32	32	48,715	7	50	300
AB7IZ034	34	34	52,390	7	50	300
AB7IZ036	36	36	54,424	7	50	300
AB7IZ038	38	38	52,680	7	50	300
AB7IZ040	40	40	66,660	7	50	300
AB7IZ050	50	50	74,038	7	50	200



Abrazadera doble isofónica M7. Zincada

AB-7ID Z



SANEAMIENTO



CÓDIGO	MEDIDA	ØD(MM)	€/100	MEDIDA EN PULGADAS		
AB7IDZ0810	08-10	08-10	51,200	7	50	600
AB7IDZ1012	10-12	10-12	55,825	7	50	600
AB7IDZ1214	12-14	12-14	56,510	7	50	600
AB7IDZ1416	14-16	14-16	62,147	7	50	300
AB7IDZ1618	16-18	16-18	69,170	7	50	300
AB7IDZ1820	18-20	18-20	72,253	7	50	300
AB7IDZ2022	20-22	20-22	82,093	7	50	300
AB7IDZ2224	22-24	22-24	86,910	7	50	200
AB7IDZ2628	26-28	26-28	109,218	7	50	200





Grapa 1 pie

AB-PI



SANEAMIENTO



CÓDIGO	MEDIDA	ØD(MM)	€/100	CARGA MÁXIMA		
ABPI006	6	6	6,023	30	100	2.400
ABPI008	8	8	6,701	30	100	2.400
ABPI010	10	10	7,375	30	100	2.400
ABPI012	12	12	7,629	30	100	2.400
ABPI014	14	14	9,529	30	100	2.400
ABPI016	16	16	11,147	30	100	1.200
ABPI018	18	18	12,340	30	100	1.200
ABPI020	20	20	14,380	30	100	1.200
ABPI022	22	22	16,033	30	100	600
ABPI025	25	25	17,880	30	100	600
ABPI026	26	26	19,263	30	100	600
ABPI028	28	28	19,429	30	100	600
ABPI032	32	32	26,007	30	100	600
ABPI040	40	40	36,363	30	50	300
ABPI042	42	42	42,037	30	50	300
ABPI047	47	47	43,807	30	50	200
ABPI050	50	50	45,310	30	50	200
ABPI063	63	63	67,920	30	50	200





Grapa puente

AB-PU



SANEAMIENTO



CÓDIGO	MEDIDA	ØD(MM)	€/100	CARGA MÁXIMA		
ABPU016	16	16	14,180	75	100	1.200
ABPU018	18	18	14,631	75	100	1.200
ABPU020	20	20	15,487	75	100	600
ABPU022	22	22	20,002	75	100	600
ABPU025	25	25	20,491	75	100	600
ABPU028	28	28	21,918	75	100	600
ABPU032	32	32	25,291	75	50	300
ABPU037	37	37	28,805	75	50	300
ABPU040	40	40	32,900	75	50	300
ABPU050	50	50	41,369	75	50	200
ABPU063	63	63	55,520	75	50	150



AB-IP

Grapa puente isofónica para montaje



02 Info. Técnica
P. 422

SANEAMIENTO



CÓDIGO	MEDIDA	ØD(MM)	€/100	Nº AGUJEROS		
ABIP015	15	15	58,610	3	50	600
ABIP018	18	18	64,583	3	50	300
ABIP022	22	22	69,447	3	50	300
ABIP026	26	26	82,823	4	50	300
ABIP028	28	28	88,540	4	50	300
ABIP035	35	35	92,710	4	50	150
ABIP042	42	42	103,016	4	25	100
ABIP048	48	48	113,581	4	25	100
ABIP054	54	54	122,453	5	25	100
ABIP060	60	60	151,256	5	25	75
ABIP067	67	67	166,573	5	25	75
ABIP075	75	75	175,943	6	25	75
ABIP090	90	90	218,327	6	25	75



AB-SI

Soporte para grapa puente isofónica

AB-SI

Soporte para grapa puente isofónica



02 Info. Técnica
P. 423

SANEAMIENTO



CÓDIGO	MEDIDA	€/100	Nº AGUJEROS		
ABSI003	3	205,080	3	25	-
ABSI004	4	234,094	4	25	-
ABSI005	5	269,088	5	25	150
ABSI006	6	299,993	6	25	-
ABSI007	7	325,637	7	25	-
ABSI008	8	357,548	8	25	-
ABSI009	9	389,667	9	25	-
ABSI010	10	420,953	10	25	-
ABSI011	11	455,681	11	25	-
ABSI012	12	494,723	12	25	-
ABSI013	13	521,730	13	25	-
ABSI014	14	553,970	14	25	-
ABSI015	15	588,850	15	25	-
ABSI016	16	622,003	16	10	-
ABSI017	17	656,067	17	10	-
ABSI018	18	698,129	18	10	-
ABSI019	19	713,510	19	10	-
ABSI020	20	753,685	20	10	-
ABSI021	21	777,394	21	10	-
ABSI022	22	810,823	22	10	-
ABSI025	25	908,216	25	10	-



AB-TO

Tornillo para montaje AB-IP



SANEAMIENTO



CÓDIGO	MEDIDA	€/100	
ABT006015	M6 x 15	8,887	100

Abrazadera sin fin

AB-SF



 Info
Técnica
P. 423

SANEAMIENTO





AB-SF

Zincada

CÓDIGO	MEDIDA	ØD(MM)	€/100		
ASF008016	8-16	8-16	30,913	100	1.200
ASF012022	12-22	12-22	31,741	100	600
ASF016027	16-27	16 - 27	33,755	100	600
ASF020032	20-32	20 - 32	37,657	100	600
ASF025040	25-40	25 - 40	42,619	100	400
ASF030045	30-45	30 - 45	47,548	100	300
ASF035050	35-50	35 - 50	50,343	100	200
ASF040060	40-60	40 - 60	55,385	100	200
ASF050070	50-70	50 - 70	64,640	50	100
ASF060080	60-80	60 - 80	67,770	50	100
ASF070090	70-90	70 - 90	70,984	50	-
ASF080100	80-100	80 - 100	74,235	50	-
ASF090110	90-110	90 - 110	83,210	50	-
ASF100120	100-120	100 - 120	93,290	25	-
ASF110130	110-130	110 - 130	95,960	25	-
ASF120140	120-140	120 - 140	103,216	25	-
ASF130150	130-150	130 - 150	107,890	25	-



 Blíster

CÓDIGO	MEDIDA	€/BOLSA	PCS 	BOLSAS 
BZASF008016	8-16	2,582	2	20
BZASF012022	12-22	2,582	2	20
BZASF016027	16-27	2,582	2	20
BZASF020032	20-32	2,582	2	10
BZASF025040	25-40	2,582	2	10



 Info
Técnica
P. 424

INOXIDABLE



AB-SF A2

Inoxidable A2

CÓDIGO	MEDIDA	ØD(MM)	€/100		
ASF2010016	10-16	10-16	95,663	100	1.200
ASF2012020	12-20	12-20	98,043	100	600
ASF2016027	16-27	16 - 27	102,270	100	600
ASF2020032	20-32	20 - 32	115,347	100	600
ASF2025040	25-40	25 - 40	126,033	100	200
ASF2032050	32-50	32 - 50	175,423	100	300
ASF2040060	40-60	40 - 60	186,260	100	200
ASF2050070	50-70	50 - 70	194,387	50	100
ASF2060080	60-80	60 - 80	204,343	50	100
ASF2070090	70-90	70 - 90	215,207	50	100
ASF2080100	80-100	80 - 100	222,420	50	100
ASF2090110	90-110	90 - 110	259,380	50	100
ASF2100120	100-120	100 - 120	269,563	25	75
ASF2110130	110-130	110 - 130	279,720	25	50
ASF2120140	120-140	120 - 140	293,967	25	75
ASF2130150	130-150	130 - 150	305,160	25	50



AB-SF IR

Abrazadera sin fin inoxidable en rollo

AB-SF IR

Kit (Rollo 3 m. + 8 cabezales).
Inoxidable



INOXIDABLE



CÓDIGO	MEDIDA	€/PC		
ASFIR03	9 x 0,6 mm/ 3 m	14,867	1	50

AB-SF IRC

Cabezal inoxidable



INOXIDABLE



CÓDIGO	MEDIDA	€/100		
ASFIRCA	Cabezal	106,197	50	1.000

AB-SF IRR

Rollo 30 m. Inoxidable



INOXIDABLE



CÓDIGO	MEDIDA	€/PC		
ASFIR30	9 x 0,6 mm/ 30 m	53,097	1	10

CI-PE

Cinta perforada

CI-PE

Cinta perforada curva. ATLANTIS C2-M



SANEAMIENTO



CÓDIGO	MEDIDA	€/PC	UD. MIN. VENTA		
CIPE1208	12 x 0,8 x 10 m	7,810	10	1	40
CIPE1708	17 x 0,8 x 10 m	10,192	10	1	30

CI-PE A2

Cinta perforada curva. Inoxidable A2



INOXIDABLE



CÓDIGO	MEDIDA	€/PC		
CIPEA21708	17 x 0,8 x 10 m	38,243	1	30

CI-PR

Cinta perforada recta ATLANTIS C2-M



SANEAMIENTO



CÓDIGO	MEDIDA	€/PC	UD. MIN. VENTA		
CIPR1208	12 x 0,8 x 10 m	8,096	5	1	40
CIPR1908	19 x 0,8 x 10 m	11,803	5	1	30

Abrazadera cromada M6

AB-CR

 Info
Técnica
P. 425

SANEAMIENTO



CÓDIGO	MEDIDA	ØD(MM)	€/100	CARGA MÁXIMA		
ABCR010	10 (M6)	10	30,737	70	100	1.200
ABCR012	12 (M6)	12	33,103	70	100	1.200

Abrazadera inoxidable Indextube



AB-IT

SANEAMIENTO



AB-ITS

Simple

CÓDIGO	MEDIDA	€/100		
ABITS015	15	193,863	100	600
ABITS018	18	210,063	100	400
ABITS022	22	311,367	100	400
ABITS028	28	418,547	100	300





SANEAMIENTO



AB-ITD

Doble

CÓDIGO	MEDIDA	€/100		
ABITD015	15	716,737	50	300
ABITD018	18	811,463	50	200
ABITD022	22	1.016,350	50	100





Abrazadera butano

AB-BU

 Info
Técnica
P. 425

SANEAMIENTO



CÓDIGO	MEDIDA	ØD(MM)	€/100		
ABBU1315	13 - 15	13-15	31,403	50	600
ABBU1618	16 - 18	16-18	31,403	50	600
ABBU1921	19 - 21	19-21	48,410	50	600

AB-GM

Abrazadera gásmica con tirafondo amarilla



SANEAMIENTO



CÓDIGO	MEDIDA	ØD(MM)	€/100	CARGA MÁXIMA		
ABGM012	12 (M6)	12	37,747	70	100	600
ABGM015	15 (M6)	15	40,047	70	100	600
ABGM018	18 (M6)	18	40,713	70	100	600
ABGM022	22 (M6)	22	43,443	70	50	200
ABGM028	28 (M6)	28	45,877	70	50	200
ABGM035	35 (M6)	35	56,973	70	50	200



De acuerdo a
UNE-EN ISO 4892

AB-GS

Abrazadera gásmica negra M6 con tirafondo



SANEAMIENTO



CÓDIGO	MEDIDA	ØD(MM)	€/100	CARGA MÁXIMA		
ABGS010	10 (M6)	10	38,163	70	100	600
ABGS012	12 (M6)	12	38,840	70	100	600
ABGS015	15 (M6)	15	38,510	70	100	600
ABGS018	18 (M6)	18	39,580	70	100	600
ABGS022	22 (M6)	22	42,957	70	50	200
ABGS028	28 (M6)	28	45,823	70	50	200
ABGS035	35 (M6)	35	54,777	70	50	200
ABGS042	42 (M6)	42	60,427	70	25	100
ABGS054	54 (M6)	54	81,467	70	25	100



De acuerdo a
UNE-EN ISO 4892

AB-GD

Abrazadera gásmica negra doble M6 con tirafondo



SANEAMIENTO



CÓDIGO	MEDIDA	ØD(MM)	€/100	CARGA MÁXIMA		
ABGD012	12 (M6)	12	52,833	100	50	300
ABGD015	15 (M6)	15	57,043	100	50	300
ABGD018	18 (M6)	18	64,193	100	50	300
ABGD022	22 (M6)	22	65,787	100	50	200
ABGD028	28 (M6)	28	86,600	100	50	200



De acuerdo a
UNE-EN ISO 4892



SISTEMAS DE PROTECCIÓN CONTRA INCENDIOS



AB-PE

Abrazadera colgante pera

02 Info. Técnica
P. 426

SANEAMIENTO



CÓDIGO	MEDIDA	ØD(MM)	€/100	MEDIDA EN PULGADAS	CARGA MÁXIMA		
ABPE028	28 (M10)	DN 20	88,830	28	154	50	200
ABPE035	35 (M10)	DN 25	93,163	35	186	50	200
ABPE040	40 (M10)	DN 32	109,617	40	195	50	200
ABPE048	48 (M10)	DN 40	109,653	48	236	50	200
ABPE060	60 (M10)	DN 50	124,213	60	288	50	200
ABPE075	75 (M10)	DN 65	143,643	75	426	25	100
ABPE090	90 (M10)	DN 80	161,763	90	481	25	100
ABPE100	100 (M10)	DN 90	199,350	100	569	25	100
ABPE115	115 (M10)	DN 100	269,683	115	669	25	100
ABPE140	140 (M12)	DN 125	480,493	140	907	10	40
ABPE160	160 (M12)	DN 150	589,474	160	1186	10	40
ABPE220	220 (M12)	DN 200	982,457	220	1723	10	40

AB-CH

Abrazadera para tubería Clevis

02 Info. Técnica
P. 427

SANEAMIENTO



CÓDIGO	HOMOLOGACIÓN	MEDIDA	ØD(MM)	€/100	
ABCH00034	UL	3/4"	28	283,973	50
ABCH01000	UL	1"	35	299,710	50
ABCH01012	UL	1 1/2"	48	325,617	50
ABCH01014	UL	1 1/4"	42	301,577	50
ABCH02000	UL	2"	60	333,433	50
ABCH02012	UL & FM	2 1/2"	75	607,443	30
ABCH03000	UL & FM	3"	90	626,687	25
ABCH04000	UL & FM	4"	115	1.150,460	25
ABCH05000	UL & FM	5"	140	1.596,087	25
ABCH06000	UL & FM	6"	160	2.258,957	10
ABCH08000	UL & FM	8"	220	3.386,197	10
ABCH10000	UL	10"	275	5.775,397	1
ABCH12000	UL	12"	325	7.666,323	1
ABCH14000	-	14"	355	9.901,050	1
ABCH16000	-	16"	405	14.220,860	1

AB-CI

Collarín intumescente

METAL



CÓDIGO	MEDIDA	€/PC	
ABCIKIT25	2,5 m x 50 mm	498,854	1
ABCIKIT30	3 m x 50 mm	595,637	1



AN-CU

Anclaje metálico tipo cuña. Homologado ETE

02 Info. Técnica
P. 392

MACIZOS

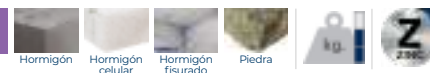

CÓDIGO	MEDIDA	€/100	Ø BROCA		
ANCU06040	6 x 40 Ø6	29,150	6	100	1.200
ANCU06070	6 x 70 Ø6	43,747	6	100	1.200





SOPORTES PARA CANALONES

TE

Soportes de canalón

TE-MO

Módulo para canal de PVC

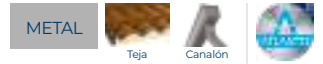

CÓDIGO	ØD(MM)	A (MM)	€/100	
TEM025	100	60	563,180	50
TEM033	150	80	694,120	50

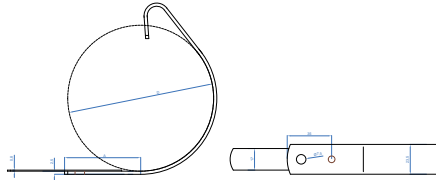

TE-GA

Gancho para canal de PVC

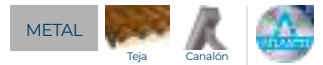
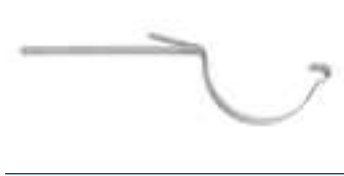

CÓDIGO	ØD(MM)	€/100	
TEGA25	100	488,190	50
TEGA33	150	510,044	50

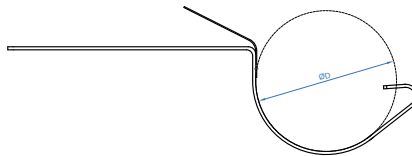

TE-GR

Placa teja grande



CÓDIGO	A (MM)	B(MM)	L(MM)	€/100	
TEGR2530	35	50	80	268,569	50

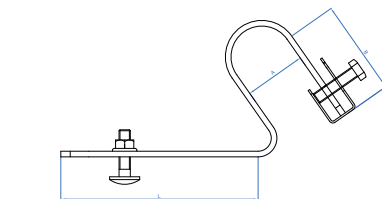

TE-PE

Placa teja



CÓDIGO	A (MM)	B(MM)	L(MM)	€/100	
TEPE2530	22	50	100	253,488	50

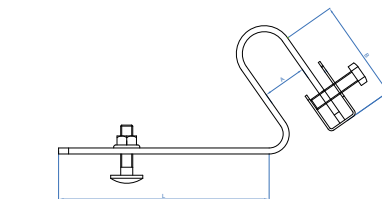



ABRAZADERAS PLÁSTICAS



Las bridas de Nylon® y sus accesorios son uno de los productos de mayor demanda en el mundo de la instalación profesional. Están indicadas para todo tipo de aplicaciones, tales como instalaciones eléctricas, jardinería, cableado industrial, construcción, DIY, cadenas de fabricación o instalaciones fotovoltaicas. La gama de bridas de INDEX está compuesta de una amplia variedad de colores y tamaños, bridas detectables y accesorios varios. Contamos con la certificación UNE-EN 62275 (marcado CE) y con la homologación UL.



CUALIDADES Y VENTAJAS



INSTALACIÓN RÁPIDA Y SENCILLA

El diseño ergonómico de la cola flexible de la brida facilita un enhebrado fácil y suave.



ALTAS PRESTACIONES

El diseño del cabezal garantiza una alta resistencia a la tracción, garantizando un fuerte tensado. Hasta 122,3 Kg* de carga de rotura según EN 50146.

*En brida con anchura de 12 mm.



DENTADO INTERIOR

El diseño del dentado interior asegura un óptimo ajuste de la brida sin dañar el objeto a fijar.



MÁXIMA CALIDAD Y GARANTÍAS

La calidad de las bridas de INDEX está garantizada con los más altos estándares de calidad, gracias a la certificación de acuerdo con la norma UNE-EN 62275, que permite el marcado CE y con homologación UL.

APLICACIONES



- Cableados en general:
- Cableados eléctricos, sujeción de mangueras, agrupación de mangueras de cables
- Plantas Solares
- Automoción y Aeronáutica
- Embalaje de Productos
- Parques Infantiles
- Industria Farmacéutica y Alimentación
- Bricolaje y Jardinería
- Arte y Manualidades
- Instalaciones con requisitos HACCP/APPCC (bridas desechables)

GAMA



BRIDAS BLANCAS Y NEGRAS

Las bridas de Nylon® blancas y negras de dentado interior son muy versátiles, ya que sirven para numerosos usos en múltiples industrias. Están disponibles en una gran variedad de tamaños, permitiendo una óptima fijación del elemento a fijar, ya sean mazos de cables, tubos y/o mangueras.

Las bridas negras, fabricadas con poliamida y aditivo negro, disponen de una mayor resistencia a la radiación ultravioleta, siendo aptas para aplicaciones en exterior. Las bridas blancas (naturales) están indicadas para aplicaciones en interior.

Son idóneas para uso en instalaciones donde sea necesaria una alta resistencia a álcalis, aceites, grasas, derivados del aceite o disolventes clorados. Por el contrario, tienen una resistencia limitada a ácidos y no son resistentes a fenoles.



BRIDAS DE COLORES

Las bridas de colores están indicadas para el cableado en cajas de conexión en las que se agrupan distintos mazos de cables, permitiendo identificarlos de manera rápida y sencilla y posibilitando ordenar visualmente el espacio de trabajo. También se utilizan en aquellas aplicaciones donde se requiera que las bridas pasen desapercibidas (vallados).

Disponibles en una amplia gama de medidas en color **marrón, amarillo, azul, rojo, verde y gris**.



BRIDAS DETECTABLES

Las bridas detectables están especialmente diseñadas para la utilización en la industria alimentaria, cosmética, farmacéutica y en todas aquellas que sean aplicaciones donde se deben **cumplir los requisitos de la metodología HACCP* o APPCC** (Análisis de Peligros y Puntos Críticos de Control).

Fabricadas en Poliamida 6.6 con partículas metálicas, disponen de **propiedades magnéticas que permiten la detección** con un detector de metales, así como por equipos de inspección de rayos X. Además, su particular color azul facilita su detección visual.

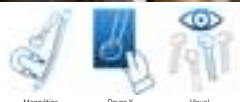

PACKAGING Y PUNTO DE VENTA



La bolsa donde se venden las bridas dispone de toda la información necesaria de un solo vistazo.

En la etiqueta está impreso las dimensiones de la brida, la temperatura de uso, el tamaño mínimo y máximo de diámetro, la tensión soportada, código o EAN. Se trata de una bolsa de plástico de alta calidad que garantiza su estanqueidad para mantener el contenido de humedad recomendada.

Las bridas se presentan tres opciones de presentación en lineal:



BOLSAS COLGADAS EN GANCHOS



BOLSAS COLOCADAS EN BANDEJAS



BOLSAS EN CAJAS EXPOSITOAS

RECOMENDACIONES DE USO Y ALMACENAJE DE LAS BRIDAS

Las bridas de INDEX están fabricadas en poliamida de alta calidad, un material plástico higroscópico, es decir, que el material absorbe y pierde agua en función de las condiciones externas (humedad y temperatura). Para garantizar una correcta manipulación y una óptima conservación de la poliamida, las bolsas de bridas contienen el nivel de humedad adecuado.

Recomendamos seguir las siguientes indicaciones para un correcto comportamiento del producto:



No abrir la bolsa hasta el momento de usarlas y una vez abiertas utilizarlas lo antes posible o bien almacenarlas en bolsas de plástico herméticas.



No almacenar cerca de fuentes de calor.



Condiciones óptimas de almacenamiento: 23°C de temperatura y 50% de humedad relativa.



No exponer directamente al sol.



Bridas de nylon

BN

MULTIMATERIAL

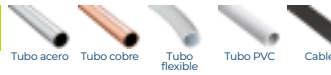

BN-N

Negra

CÓDIGO	MEDIDA	€/100		
BN25080	2,5 x 80	1,153	100	1.000
BN25100	2,5 x 100	1,277	100	1.000
BN25140	2,5 x 140	2,013	100	1.000
BN25160	2,5 x 160	2,190	100	1.000
BN25200	2,5 x 200	2,622	100	1.000
BN36140	3,6 x 140	2,780	100	1.000
BN36200	3,6 x 200	3,787	100	1.000
BN36250	3,6 x 250	4,938	100	1.000
BN36300	3,6 x 300	5,792	100	1.000
BN36370	3,6 x 370	7,610	100	1.000
BN48120	4,8 x 120	4,059	100	1.000
BN48160	4,8 x 160	4,423	100	1.000
BN48180	4,8 x 180	4,818	100	1.000
BN48200	4,8 x 200	4,825	100	1.000
BN48250	4,8 x 250	6,965	100	1.000
BN48290	4,8 x 290	7,464	100	1.000
BN48370	4,8 x 370	9,728	100	1.000
BN48430	4,8 x 430	12,944	100	1.000
BN76150	7,6 x 150	10,493	100	1.000
BN76200	7,6 x 200	11,246	100	1.000
BN76290	7,6 x 290	14,749	100	1.000
BN76370	7,6 x 370	17,583	100	1.000
BN76450	7,6 x 450	26,274	100	1.000
BN76540	7,6 x 540	30,746	100	1.000
BN76750	NEW 7,6 x 750	43,245	100	1.000
BN88770	8,8 x 770	59,097	50	1.000
BN88920	NEW 8,8 x 920	84,835	50	500
BN88122	NEW 8,8 x 1220	114,303	50	500
BN12225	12,5 x 225	39,489	50	500
BN12500	12,5 x 500	80,734	50	500
BN12720	12,5 x 720	114,684	50	500
BN12850	12,5 x 850	132,620	50	500
BN12100	12,5 x 1000	162,834	50	500



MULTIMATERIAL

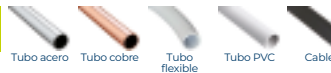

BN-B

Blanca

CÓDIGO	MEDIDA	€/100		
BB25080	2,5 x 80	1,177	100	1.000
BB25100	2,5 x 100	1,340	100	1.000
BB25140	2,5 x 140	2,093	100	1.000
BB25160	2,5 x 160	2,277	100	1.000
BB25200	2,5 x 200	2,810	100	1.000
BB36140	3,6 x 140	2,890	100	1.000
BB36200	3,6 x 200	3,937	100	1.000
BB36250	3,6 x 250	5,350	100	1.000
BB36300	3,6 x 300	6,147	100	1.000
BB36370	3,6 x 370	8,243	100	1.000
BB48120	4,8 x 120	4,263	100	1.000
BB48160	4,8 x 160	4,693	100	1.000
BB48180	4,8 x 180	5,060	100	1.000
BB48200	4,8 x 200	5,120	100	1.000
BB48250	4,8 x 250	7,390	100	1.000
BB48290	4,8 x 290	7,920	100	1.000
BB48370	4,8 x 370	10,323	100	1.000
BB48430	4,8 x 430	14,023	100	1.000
BB76150	7,6 x 150	10,913	100	1.000
BB76200	7,6 x 200	11,813	100	1.000
BB76290	7,6 x 290	15,187	100	1.000
BB76370	7,6 x 370	18,287	100	1.000
BB76450	7,6 x 450	28,170	100	1.000
BB76540	7,6 x 540	32,627	100	1.000
BB88770	8,8 x 770	62,397	50	1.000
BB12225	12,5 x 225	41,693	50	500
BB12500	12,5 x 500	85,243	50	500
BB12720	12,5 x 720	121,087	50	500
BB12850	12,5 x 850	140,027	50	500
BB12100	12,5 x 1000	171,927	50	500



BN-CO

Bridas de nylon colores

BN-GR

Gris



MULTIMATERIAL



CÓDIGO	MEDIDA	€/100		
BC25100GR	2,5 x 100	1,513	100	50.000
BC36140GR	3,6 x 140	3,637	100	30.000
BC36200GR	3,6 x 200	4,920	100	25.000
BC48200GR	4,8 x 200	6,400	100	16.000
BC48290GR	4,8 x 290	10,063	100	11.000

BN-VE

Verde



MULTIMATERIAL



CÓDIGO	MEDIDA	€/100		
BC25100VE	2,5 x 100	1,513	100	50.000
BC36140VE	3,6 x 140	3,637	100	30.000
BC36200VE	3,6 x 200	4,920	100	25.000
BC48200VE	4,8 x 200	6,400	100	16.000
BC48290VE	4,8 x 290	10,063	100	11.000

BN-MA

Marrón



MULTIMATERIAL



CÓDIGO	MEDIDA	€/100		
BC25100MA	2,5 x 100	1,513	100	50.000
BC36140MA	3,6 x 140	3,637	100	30.000
BC36200MA	3,6 x 200	4,920	100	25.000
BC48200MA	4,8 x 200	6,400	100	16.000
BC48290MA	4,8 x 290	10,063	100	11.000

BN-AM

Amarilla



MULTIMATERIAL



CÓDIGO	MEDIDA	€/100		
BC25100AM	2,5 x 100	1,513	100	50.000
BC36140AM	3,6 x 140	3,637	100	30.000
BC36200AM	3,6 x 200	4,920	100	25.000
BC48200AM	4,8 x 200	6,400	100	16.000
BC48290AM	4,8 x 290	10,063	100	11.000

BN-AZ

Azul



MULTIMATERIAL



CÓDIGO	MEDIDA	€/100		
BC25100AZ	2,5 x 100	1,513	100	50.000
BC36140AZ	3,6 x 140	3,637	100	30.000
BC36200AZ	3,6 x 200	4,920	100	25.000
BC48200AZ	4,8 x 200	6,400	100	16.000
BC48290AZ	4,8 x 290	10,063	100	11.000

BN-RO

Roj



MULTIMATERIAL



CÓDIGO	MEDIDA	€/100		
BC25100RO	2,5 x 100	1,513	100	50.000
BC36140RO	3,6 x 140	3,637	100	30.000
BC36200RO	3,6 x 200	4,920	100	25.000
BC48200RO	4,8 x 200	6,400	100	16.000
BC48290RO	4,8 x 290	10,063	100	11.000



Brida detectable

BN-DT

MULTIMATERIAL

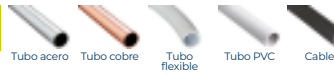

CÓDIGO	MEDIDA	€/100		
BNDT25100	2,5 x 100	3,131	100	50.000
BNDT36150	3,6 x 150	7,179	100	30.000
BNDT36200	3,6 x 200	9,614	100	25.000
BNDT48200	4,8 x 200	11,748	100	16.000
BNDT48300	4,8 x 300	18,155	100	11.000
BNDT48370	4,8 x 370	25,631	100	8.000
BNDT76370	7,6 x 370	46,994	100	5.000



Taco para bridas

TACOBRI

MULTIMATERIAL



CÓDIGO	MEDIDA	COLOR	€/100		
TACOBRIE8	Ø8	NEGRO	5,823	100	5.000
TACOBRIE6	Ø6	NEGRO	6,993	100	5.000

TACOBRI N

Negro



Blíster

CÓDIGO	MEDIDA	€/BOLSA	PCS	BOLSAS
BZTABRIE8	Ø8	2,040	4	15

MULTIMATERIAL



CÓDIGO	MEDIDA	COLOR	€/100		
TACOBRI B8	Ø8	BLANCO	6,290	100	5.000
TACOBRI B6	Ø6	BLANCO	7,213	100	5.000

TACOBRI B

Blanco



Blíster

CÓDIGO	MEDIDA	€/BOLSA	PCS	BOLSAS
BZTABRI B8	Ø8	2,040	4	15

MULTIMATERIAL



CÓDIGO	MEDIDA	COLOR	€/100		
TACOBRI GR8	Ø8	GRIS	8,043	100	5.000

TACOBRI G

Gris



BN-ID

Bridas de nylon con identificación



MULTIMATERIAL



CÓDIGO	MEDIDA	€/100		
BID25110	2,5 x 110	8,573	100	16.000
BID25210	2,5 x 210	18,860	100	12.000

BN-PL

Placa de identificación de nylon de hasta 4,8 mm

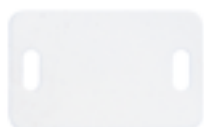

MULTIMATERIAL



CÓDIGO	MEDIDA	€/100		
BPLO2616	26,4 x 16,2	23,070	100	5.000

BN-BA

Base de dos vías adhesivas para bridas de nylon



MULTIMATERIAL



CÓDIGO	MEDIDA	COLOR	€/100		
BBANA19	19 x 19	BLANCO	17,560	100	15.000
BBANE19	19 x 19	NEGRO	17,560	100	15.000
BBANA27	27 x 27	BLANCO	25,117	100	6.000
BBANE27	27 x 27	NEGRO	25,117	100	6.000

AB-IN

Clip simple de polipropileno con casquillo de latón M6



02 Info. Técnica P. 427

SANEAMIENTO



CÓDIGO	MEDIDA	ØD(MM)	€/100		
ABIN012	12	12	30,837	100	1.200
ABIN014	14-15	14-15	33,000	100	600
ABIN016	16-18	16-18	42,203	100	600
ABIN020	20-22	20-22	44,200	100	400
ABIN025	25	25	57,200	50	300
ABIN028	28	28	57,190	50	300
ABIN032	32	32	76,667	25	150
ABIN035	35	35	85,147	25	300

INSTALACIÓN

PERFIL





Clip doble de polipropileno con casquillo de latón M6

AB-ID

02
P. 428 Info
Técnica

SANEAMIENTO



CÓDIGO	MEDIDA	ØD(MM)	€/100		
ABID012	12	12	66,623	50	200
ABID014	14-15	14-15	69,937	50	300
ABID016	16-18	16-18	89,240	50	200
ABID020	20-22	20-22	94,533	50	150
ABID028	28	28	116,717	25	100



INSTALACIÓN

PERFIL



20/10

Abrazadera guía simple con pre-rosca M6

AB-GU

02
P. 428 Info
Técnica

SANEAMIENTO



CÓDIGO	MEDIDA	ØD(MM)	€/100		
ABGUG15	15	15	24,737	100	400
ABGUG18	18	18	24,987	100	400
ABGUG20	20	20	26,300	100	400
ABGUG22	22	22	27,857	100	300
ABGUG25	25	25	30,950	50	300
ABGUG28	28	28	38,713	50	200
ABGUG32	32	32	42,153	25	150
ABGUG40	40	40	56,067	25	150
ABGUG50	50	50	67,237	25	100



INSTALACIÓN

PERFIL

20/10
27/18
28/30

PISTOLA



TACO + TORNILLO



CAÑÓN ELECTRICISTA



Abrazadera multidímetro

AB-MUG

02
P. 428 Info
Técnica

SANEAMIENTO



CÓDIGO	MEDIDA	ØD(MM)	€/100		
ABMUG15	15-16	15	21,977	100	400
ABMUG18	18-20	18	27,703	100	400
ABMUG22	22-25	22	32,910	100	300
ABMUG26	26-28	26	41,103	50	150
ABMUG32	32-35	32	53,047	50	150
ABMUG40	40-42	40	71,767	50	100
ABMUG48	48-50	42	86,263	25	75



INSTALACIÓN

PERFIL

20/10
27/18
28/30

PISTOLA



TACO + TORNILLO



CAÑÓN ELECTRICISTA



AB-PR

Abrazadera a presión con pre-rosca M6



02 Info. Técnica
P. 429

SANEAMIENTO



CÓDIGO	MEDIDA	ØD(MM)	€/100		
ABPRG15	15-18	15-18	25,473	100	400
ABPRG20	20-22	20-22	26,651	100	400
ABPRG25	25-28	25-28	31,812	100	300
ABPRG32	32-35	32-35	44,632	25	150
ABPRG40	40	40	57,893	25	150
ABPRG50	50	50	72,970	25	100

INSTALACIÓN



AB-MS

Abrazadera multitubo + taco. Simple



02 Info. Técnica
P. 429

SANEAMIENTO



CÓDIGO	MEDIDA	ØD(MM)	€/100	CARGA MÁXIMA		
ABMS10	5 x 20 Ø5	10	29,840	9	100	1.200
ABMS12	5 x 20 Ø5	12	31,807	9	100	1.200
ABMS14	6 x 25 Ø6	14	44,337	15	100	600
ABMS16	6 x 25 Ø6	16	45,760	15	100	600
ABMS18	8 x 30 Ø8	18	60,177	16	100	300
ABMS20	8 x 30 Ø8	20	61,607	16	50	300
ABMS22	8 x 30 Ø8	22	62,973	16	50	300
ABMS26	10 x 40 Ø10	26	117,341	30	50	150
ABMS28	10 x 40 Ø10	28	120,423	30	50	150

AB-MD

Abrazadera multitubo + taco. Doble



02 Info. Técnica
P. 429

SANEAMIENTO



CÓDIGO	MEDIDA	ØD(MM)	€/100	CARGA MÁXIMA		
ABMD10	8 x 30 Ø8	10	59,007	16	100	300
ABMD12	8 x 30 Ø8	12	60,207	16	100	300
ABMD14	8 x 30 Ø8	14	61,410	16	100	300
ABMD16	8 x 30 Ø8	16	60,443	16	100	300
ABMD18	10 x 40 Ø10	18	85,397	30	100	200
ABMD20	10 x 40 Ø10	20	90,643	30	50	150
ABMD22	10 x 40 Ø10	22	93,360	30	50	150
ABMD26	10 x 40 Ø10	26	149,040	30	50	100
ABMD28	10 x 40 Ø10	28	150,180	30	50	100



Taco para fijación de tubo INDEXring

AB-T

02
P. 430
Info
Técnica

SANEAMIENTO



CÓDIGO	MEDIDA	ØD(MM)	€/100		
ABTS014	14	14 - 15	36,335	100	600
ABTS016	16	16 - 17	37,643	100	400
ABTS018	18	18 - 19	40,678	100	400
ABTS020	20	20 - 21	41,358	100	300
ABTS022	22	22 - 23	42,415	100	300
ABTS025	25	25 - 26	43,792	100	300
ABTS028	28	28 - 29	51,988	100	200
ABTS032	30	30 - 32	67,008	50	150

AB-TS

Simple

02
P. 430
Info
Técnica

SANEAMIENTO



CÓDIGO	MEDIDA	ØD(MM)	€/100		
ABTD016	16	15 - 16	43,877	100	400
ABTD018	18	18 - 19	49,892	100	300
ABTD020	20	20 - 21	51,082	100	200
ABTD022	22	22 - 23	55,005	100	200
ABTD025	25	25 - 26	59,894	100	200
ABTD028	28	28 - 29	79,039	50	150

AB-TD

Doble

02
P. 430
Info
Técnica

SANEAMIENTO



CÓDIGO	MEDIDA	ØD(MM)	€/100		
ABTC020	20	20 - 21	83,320	50	100
ABTC025	25	25 - 26	102,450	50	100

AB-TC

Cuádruple



FI-CA

Fijaciones para cables

FI-CA AB

Abrazadera



MULTIMATERIAL



CÓDIGO	MEDIDA	€/100		
FICAAB080	80	150,544	50	
FICAAB119	119	250,907	25	

FI-CA PS

Pinza simple



MULTIMATERIAL



CÓDIGO	MEDIDA	€/100		
FICAPS080	80	72,136	50	1.500

FI-CA PD

Pinza doble



MULTIMATERIAL



CÓDIGO	MEDIDA	€/100		
FICAPD160	80 (x2)	106,635	50	800

FI-CA CL

Clip



MULTIMATERIAL



CÓDIGO	MEDIDA	€/100	TALADRO		
FICACL13	Ø13	15,368	6	200	2.400
FICACL26	Ø16	20,386	6	100	1.200

SANEAMIENTO



CÓDIGO	MEDIDA	€/100	UD. MIN. VENTA	
GRBL001	2 x 0,7	6,390	400	100
GRBL010	2 x 0,7 - 2 x 1	8,117	400	100
GRBL100	2 x 4	11,570	200	100
GRBL120	3 x 6	14,207	200	100
GRBL140	4 x 6	16,877	200	100
GRBL002	2 x 0,4 - 0,7 ó 1	6,740	400	100
GRBL020	2 x 1,5 - 3 x 1	8,243	400	100
GRBL003	2 x 1 - 3 x 0,7	6,820	400	100
GRBL030	3 x 1,5 - 3 x 2,5	9,973	400	100
GRBL040	1 x 1 - 2 x 0,5	7,860	400	100
GRBL050	2 x 0,75	8,073	400	100
GRBL060	2 x 1	8,550	400	100
GRBL070	2 x 1-1,5	9,327	400	100
GRBL080	2 x 2,5	9,410	400	100
GRBL090	3 x 2,5	10,363	400	100

GR-NY BL

Grapilla de nylon con clavo de acero zincado. Blanca



Blíster

CÓDIGO	MEDIDA	€/BOLSA	PCS BOLSA	BOLSAS
BZGRB001	2 x 0,7	2,582	6	20
BZGRB010	2 x 0,7 - 2 x 1	2,582	6	20
BZGRB100	2 x 4	2,582	6	20
BZGRB120	3 x 6	2,582	6	15
BZGRB050	2 x 0,75	2,582	6	20
BZGRB060	2 x 1	2,582	6	20
BZGRB070	2 x 1-1,5	2,582	6	20
BZGRB080	2 x 2,5	2,582	6	20
BZGRB090	3 x 2,5	2,582	6	20

SANEAMIENTO



CÓDIGO	MEDIDA	€/100	UD. MIN. VENTA	
GRNE100	2 x 4	11,570	200	100
GRNE120	3 x 6	14,207	200	100
GRNE060	2 x 1	8,550	400	100
GRNE070	2 x 1 - 2 x 1,5	9,327	400	100
GRNE080	2 x 2,50	9,410	400	100
GRNE090	3 x 2,50	10,363	400	100



GR-NY N

Grapilla de nylon con clavo de acero zincado. Negra



SANEAMIENTO



CÓDIGO	MEDIDA	€/100	UD. MIN. VENTA		
GRNATTV	GRAPILLA - CLIP - CRAMPON TV - CLIP	11,160	200	100	2.000

GR-NY NT

Grapilla de nylon con clavo de acero zincado. Natural





PERFILERÍA Y SOPORTACIÓN



PUENTES GUÍA		TORNILLOS GUÍA		TUERCAS GUÍA		TAPONES	
GZ2718							
PGZ2830							
PGZ3840							
PGI2718							
PGI2830							
PGI3840							
PGX4121							
PGX4141							
TC230620	M6 x 20						
TC230820	M8 x 20						
TC230830	M8 x 30						
TC340830	M8 x 30						
TC341030	M10 x 30						
TCR230620	M6 x 20						
TCR230820	M8 x 20						
TCR230830	M8 x 30						
TCR340830	M8 x 30						
TCR341030	M10 x 30						
TCRX0830	M8 x 30						
TCRX0860	M8 x 60						
TCRX1030	M10 x 30						
TCRX1060	M10 x 60						
TUC201006	M6						
TUC201008	M8						
TUC271808	M8						
TUC271810	M10						
TUGRA2706	M6						
TUGRA2708	M8						
TUGRA3808	M8						
TUGRA3810	M10						
TUCX08	M8						
TUCX10	M10						
TUCXMU08	Muelle						
TUCXMU10	Muelle						
TURX08							
TURX10							
TURX12							
TURXA08							
TURXA10							
SOTP2718							
SOTP2830							
SOTP3840							
SOTP4121							
SOTP4141							

GP

Perfiles para cargas ligeras tipo "C"

GP-Z

Guía perforada zincada



METAL



CÓDIGO	MEDIDA	€/100	
GPZ201010	20 x 10 x 1 x 2000	715,913	30
GPZ250808	25 x 8 x 0,80 x 1000	590,803	30

GP-G

Guía perforada ATLANTIS C2-H



METAL



CÓDIGO	MEDIDA	€/100	
GPG271812	27 x 18 x 1,25 x 2000	1.293,857	10
GPG3M271812 NEW	27 x 18 x 1,25 x 3000	1.940,785	10
GPG283018	28 x 30 x 1,8 x 2000	2.658,370	10
GPG3M283018 NEW	28 x 30 x 1,8 x 3000	3.987,555	10
GPG351312	35 x 13 x 1,2 x 2000	1.772,080	10
GPG384020	38 x 40 x 2 x 2000	4.391,170	6
GPG402015	40 x 20 x 1,50 x 2000	1.916,430	10

GP-A2

Guía perforada inoxidable A2



INOXIDABLE



CÓDIGO	MEDIDA	€/100	
GPI271812	27 x 18 x 1,25 x 2000	11.696,187	6
GPI283015	28 x 30 x 1,50 x 2000	18.898,133	6
GPI384020	38 x 40 x 2,00 x 2000	39.110,867	5

GP-PL

Guía perforada plastificada amarilla



METAL



CÓDIGO	MEDIDA	€/100	
GPP271812	27 x 18 x 1,25	1.862,700	10

GP-PVC

Guía perforada PVC



METAL



CÓDIGO	MEDIDA	€/100	
GPV251120	25 x 11 x 2 x 1000	843,660	30

Perfiles para cargas ligeras tipo "C"

GP

METAL



CÓDIGO	MEDIDA	€/100	
GLO357510	35x7,5x1,0	777,323	10
GLO351515	35x15x1,5	1.321,680	10

GL-O

Guía Omega lisa ATLANTIS C2-M



METAL



CÓDIGO	MEDIDA	€/100	
GPO351515	35x15x1,5	1.317,593	10
GPO357510	35x7,5x1,0	736,710	10

GP-O

Guía Omega perforada ATLANTIS C2-M



Soportes para cargas ligeras tipo "C"

SP

METAL



CÓDIGO	MEDIDA	€/100	
SPZ271820	27 x 18 x 1,25 x 200	757,377	10
SPZ271830	27 x 18 x 1,25 x 300	817,293	10
SPZ384020	38 x 40 x 2 x 200	1.226,083	10
SPZ384025	38 x 40 x 2 x 250	1.362,487	10
SPZ384030	38 x 40 x 2 x 300	1.528,713	10
SPZ384035	38 x 40 x 2 x 350	1.637,843	10
SPZ384040	38 x 40 x 2 x 400	1.908,950	10
SPZ384050	38 x 40 x 2 x 500	2.318,293	10
SPZ384060	38 x 40 x 2 x 600	2.581,627	10

SP-Z

Soporte perforado zincado



METAL



CÓDIGO	MEDIDA	€/100	
SPV2718	M10 (27/18-28/30)	534,363	50
SPV3840	M10 (38/40-40/20)	576,783	50

SP-V

Soporte vertical



METAL



CÓDIGO	MEDIDA	€/100	
SPH2718	M10 (27/18-28/30)	484,577	50
SPH3840	M10 (38/40-40/20)	502,590	50

SP-H

Soporte horizontal



SP

Soportes para cargas ligeras tipo "C"

SP-HX

SopORTE horizontal carriles



METAL



CÓDIGO	MEDIDA	€/100		
SPGH2718	M10 (27/18-28/30)	745,600	10	10
SPGH3840	M10 (38/40-40/20-41/21-41/41)	1.449,113	10	10

PE-AC

Accesorios para perfiles tipo "C"

TO-GU

Tope tornillo guía



METAL



CÓDIGO	MEDIDA	€/100		
TG230620	M6 x 20	69,107	100	800
TG230820	M8 x 20	83,390	100	400
TG230830	M8 x 30	87,770	100	600
TG340830	M8 x 30	117,872	100	600
TG341030	M10 x 30	151,835	100	400

TO-GR

Tope tornillo guía de fijación rápida



METAL



CÓDIGO	MEDIDA	€/100		
TGR230620	M6x20	185,437	100	600
TGR230820	M8x20	196,013	100	600
TGR230830	M8x30	200,683	100	600
TGR340830	M8x30	252,057	100	400
TGR341030	M10x30	284,610	50	300

TU-GU

Tuerca guía perforada



METAL



CÓDIGO	MEDIDA	€/100		
TUG201006	M6	18,263	100	3.000
TUG201008	M8	18,263	100	2.400
TUG271808	M8	49,180	100	1.200
TUG271810	M10	49,180	100	1.200

TU-GRA

Tuerca guía con arandela de fijación rápida



METAL





CÓDIGO	MEDIDA	€/100		
TUGRA2706	M6	167,963	50	600
TUGRA2708	M8	167,963	50	600
TUGRA3808	M8	215,400	50	600
TUGRA3810	M10	229,303	50	600

Accesorios para perfiles tipo "C"

PE-AC

METAL



CÓDIGO	MEDIDA	€/100		
EMZ45	50 x 50 45°	128,447	100	400
EMZ90	54 x 54 90°	128,447	100	300
EMZ00	100 180°	125,237	100	-



EG-Z

Escuadra zincada



INOXIDABLE



CÓDIGO	MEDIDA	€/100		
EMI45	50 x 50 45°	653,707	50	200
EMI90	54 x 54 90°	653,707	50	-
EMI00	100 180°	648,100	50	200

EG-A2

Escuadra inoxidable A2



METAL



CÓDIGO	MEDIDA	€/100	
PUZ2718	M8 (27/18-28/30)	57,937	50
PUZ3840	M8 (38/40)	64,073	50



PU-Z

Placa de unión para perfiles



METAL



CÓDIGO	MEDIDA	€/100		
PGZ2718	27 / 18 x 81	108,377	50	300
PGZ2830	28 / 30 x 81	131,250	50	300
PGZ3840	38 / 40 x 93	146,437	50	100



PG-Z

Puente guía zincado



INOXIDABLE



CÓDIGO	MEDIDA	€/100		
PGI2718	27 / 18 x 81	318,853	50	300
PGI2830	28 / 30 x 81	366,683	50	200
PGI3840	38 / 40 x 93	446,397	50	100

PG-A2

Puente guía inoxidable A2



METAL



CÓDIGO	MEDIDA	€/100		
SOTP2718	27/18	31,793	100	400
SOTP2830	28/30	38,237	100	300
SOTP3840	38/40	61,990	100	300
SOTP4121	41/21	50,943	100	600
SOTP4141	41/41	53,413	100	300

SO-TP

Tapones plásticos



GPX

Perfiles para cargas pesadas Indextrut

GP-X 21

Guía perforada Indextrut 41x21



METAL



CÓDIGO	MEDIDA	€/100	
GPX412115	41 x 21 x 1,5	4.040,640	10
GPX412120	41 x 21 x 2	4.542,207	10
GPX2M412120	41 x 21 x 2	3.028,137	10
GPX412125	41 x 21 x 2,5	6.226,723	6

GP-X 41

Guía perforada Indextrut 41x41



METAL



CÓDIGO	MEDIDA	€/100	
GPX414115	41 x 41 x 1,5	4.904,780	10
GPX414120	41 x 41 x 2	6.997,603	6
GPX2M414120	41 x 41 x 2	4.665,067	10
GPX414125	41 x 41 x 2,5	8.572,370	6

SPX

Soportes para cargas pesadas Indextrut

SP-X

Soporte perforado Indextrut



METAL



CÓDIGO	MEDIDA	€/100	
SPX412115	41 x 21 x 2,5 x 150	1.084,823	10
SPX412130	41 x 21 x 2,5 x 300	1.508,527	10
SPX412145	41 x 21 x 2,5 x 450	1.877,453	10
SPX414110	41 x 41 x 2,5 x 1000	4.959,593	2
SPX414115	41 x 41 x 2,5 x 150	1.391,533	10
SPX414130	41 x 41 x 2,5 x 300	1.939,473	10
SPX414145	41 x 41 x 2,5 x 450	2.536,200	10
SPX414160	41 x 41 x 2,5 x 600	3.188,740	10
SPX414175	41 x 41 x 2,5 x 750	3.943,767	10

SP-RX

Soporte base rectangular "U" Indextrut



METAL



CÓDIGO	MEDIDA	€/100	
SPRXH4121	M12 (41/21-41/41)	1.367,503	12
SPRXV4121	M12 (41/21-41/41)	1.367,503	12

SP-UX

Soporte base cuadrada "U" Indextrut



METAL



CÓDIGO	MEDIDA	€/100	
SPUX412100	M16 (41/21-41/41)	1.737,687	12
SPUX412145	M16 (41/21-41/41)	1.737,687	12

Soportes para cargas pesadas Indextrut

SPX

METAL



CÓDIGO	MEDIDA	€/100	
PRX01	M8 (41/21-41/41)	1.509,770	12



PR-X

Soporte regulable Indextrut



METAL



CÓDIGO	MEDIDA	€/100		
RESX300	252 x 252 x 6 (300)	1.219,660	10	20
RESX550	428 x 428 x 6 (550)	1.942,967	10	20

RE-SX

Refuerzo para soportes Indextrut



Accesorios para perfiles Indextrut

PX-AC

METAL



CÓDIGO	MEDIDA	€/100		
SOTP2718	27/18	31,793	100	400
SOTP2830	28/30	38,237	100	300
SOTP3840	38/40	61,990	100	300
SOTP4121	41/21	50,943	100	600
SOTP4141	41/41	53,413	100	300



SO-TP

Tapones plásticos



METAL



CÓDIGO	MEDIDA	€/100		
TGX0840	M8 x 40	124,220	100	400
TGX0860	M8 x 60	135,857	50	300
TGX1040	M10 x 40	165,169	50	300
TGX1060	M10 x 60	185,259	50	200

TG-X

Tope tornillo Guía Indextrut



METAL



CÓDIGO	MEDIDA	€/100	
TGRX0830	M8x30	297,130	100
TGRX0860	M8x60	310,723	50
TGRX1030	M10x30	337,760	50
TGRX1060	M10x60	358,583	50

TO-GRX

Tope tornillo Guía de fijación rápida Indextrut



PX-AC

Accesorios para perfiles Indextrut

TU-GX

Tuerca guía Indextrut



METAL



CÓDIGO	MEDIDA	€/100		
TUGX08	M8	74,513	100	800
TUGX10	M10	82,393	100	800

TU-MU

Tuerca guía Indextrut con muelle



METAL



CÓDIGO	MEDIDA	€/100		
TUGXMU08	M8	108,883	100	400
TUGXMU10	M10	108,883	100	400

TU-RX

Tuerca guía de fijación Rápida Indextrut



METAL



CÓDIGO	MEDIDA	€/100		
TURX08	M8	103,140	100	400
TURX10	M10	117,837	100	400
TURX12	M12	130,677	50	300

TU-RXA

Tuerca guía con arandela de fijación rápida Indextrut



METAL



CÓDIGO	MEDIDA	€/100	
TURXA08	M8	248,933	50
TURXA10	M10	272,113	50

EG-X

Escuadra para Indextrut



METAL



CÓDIGO	MEDIDA	€/100	N° AGUJEROS		
EMX1302	71/48 x 40 x 5 135°	312,960	2	20	100
EMX4502	86/52 x 40 x 5 45°	293,990	2	25	125
EMX9002	48 x 51 x 5 90°	192,043	2	50	150
EMX9004	95 x 98 x 5 90°	303,477	4	25	75

Accesorios para perfiles Indextrut

PX-AC

METAL



CÓDIGO	MEDIDA	€/100	
SCRX090	100 x 100 x 40	749,803	10

SC-RX

Escuadra reforzada Indextrut



METAL



CÓDIGO	MEDIDA	€/100	
EMPX4121	M8 (41/21-41/41)	1.175,967	10

EMP-X

Empalme Indextrut



METAL



CÓDIGO	MEDIDA	€/100	
RTX01	50 x 5	829,507	10



RT-X

Soporte Rótula Indextrut



METAL



CÓDIGO	MEDIDA	€/100	N° AGUJEROS		
UNPX412101	40 x 40 x 5	79,627	1	50	300
UNPX412102	40 x 90 x 5	164,383	2	25	150
UNPX412103	40 x 138 x 5	231,167	3	25	125
UNPX412104	40 x 186 x 5	287,673	4	10	60

UN-PX

Placa de unión Indextrut



METAL



CÓDIGO	MEDIDA	€/100	N° AGUJEROS	
UNEX412103	89 x 89 x 5	418,643	3	25

UN-EX

Placa de unión Escuadra Indextrut



PX-AC

Accesorios para perfiles Indextrut

UN-TX

Placa de unión "T" Indextrut

METAL



CÓDIGO	MEDIDA	€/100	Nº AGUJEROS	
UNTX412104	138 x 89 x 5	544,233	4	25

PG-X

Puente guía Indextrut

METAL



CÓDIGO	MEDIDA	€/100		
PGX4121	41/21 x 40	386,533	15	90
PGX4141	41/41 x 40	512,320	10	60

AB-GX

Abrazadera para guía perforada Indextrut

METAL



CÓDIGO	MEDIDA	€/100	
ABGX4121	41x21 - 41x41	548,647	20

VE-AC

Accesorios de ventilación

UN-CO

Unión conducto tipo "C"

METAL



CÓDIGO	MEDIDA	€/100		
UNCO3220	32 x 20	63,473	100	400

SO-PG

Perfil de goma isofónico para soportación

METAL



CÓDIGO	MEDIDA	€/PC	
SOPG27	27/18 - 28/30 (20M)	152,687	1
SOPG38	38/40 - 40/20 (20M)	217,873	1
SOPG41	41/21 - 41/41 (20M)	222,893	1



SISTEMAS DE INSTALACIÓN Y FIJACIONES PARA PANELES SOLARES



ISF-GG

Grapas y galgas para montaje de placas

KFR-SC

Grapa fijación rápida



METAL



CÓDIGO	MEDIDA	€/100		
KFRSC3050	30 - 50	583,910	10	240

NEW KFR-SCN

Grapa fijación rápida. Negra



METAL



CÓDIGO	MEDIDA	€/100		
KFRSCN3050	30 - 50	636,463	10	240



NEW KFR-SS

Grapa fijación simple



METAL



CÓDIGO	MEDIDA	€/100		
KFRSS0850	8 x 50	331,640	10	60
KFRSS0870	8 x 70	357,153	10	60



NEW CL-GS

Grapa para fijación de paneles solares por clipado



METAL



CÓDIGO	MEDIDA	€/100		
CLGS1522	1,5-2,2	187,170	20	240

PGS-A

Perfil grapa



METAL





CÓDIGO	MEDIDA	€/100		
PGSA26	26	95,603	20	720

Crapas y galgas para montaje de placas

ISF-GG

METAL



CÓDIGO	MEDIDA	€/100		
PGSN26	26	104,207	20	720

PGS-N NEW

Perfil grapa. Negro



METAL



CÓDIGO	MEDIDA	€/100		
GMA030	30	166,647	10	120
GMA035	35	172,690	10	120
GMA040	40	190,220	10	120

GM-A

Galga de aluminio para marco



METAL



CÓDIGO	MEDIDA	€/100		
GMN030	30	166,647	10	120
GMN035	35	189,960	10	120
GMN040	40	209,243	10	120

GM-N NEW

Galga de aluminio para marco. Negra



Perfiles, uniones, guías y empalmes para estructura de apoyo

ISF-PU

METAL



CÓDIGO	MEDIDA	€/100	
GPXS4115012	41 x 41 x 1,5 - L.125mm	360,933	50
GPXS4115125	41 x 41 x 1,5 - L.1250mm	2.026,550	10
GPXS4115187	41 x 41 x 1,5 - L.1875mm	3.008,747	10
GPXS4115250	41 x 41 x 1,5 - L.2500mm	3.998,713	6
GPXS4115362	41 x 41 x 1,5 - L.3625mm	5.779,227	6

GP-XS

Guía perforada INDETRUT solar. Acero Atlantis C4-M



METAL



CÓDIGO	MEDIDA	€/100	
GPXSB415012	41 x 41 x 1,5 - L.125 mm	493,397	50

GP-XSB NEW

Guía perforada INDETRUT solar con cinta de estanqueidad de butileno



ISF-PU

Perfiles, uniones, guías y empalmes para estructura de apoyo

EMP-XS

Empalme INDEXTUT solar. Acero Atlantis C4-M. Válido para guía GP-XS



METAL



CÓDIGO	MEDIDA	€/100	
EMPXS4115	41 x 1,5	369,070	40

NEW EMP-XSD

Empalme INDEXTUT solar con tornillo DIN-603 A2 y tuerca DIN-6923 A2. Válido para guía GP-XS



METAL



CÓDIGO	MEDIDA	€/PC	MEDIDA TORNILLO	
EMPXSD4115	41 x 1,5	15,261	M8x16	1

Componentes. EMPXS4115 x 2
D603I08016 x 4
6923IM08 x 4

GP-VD

Guía perforada INDEXTUT solar para fijación en valle discontinua. Acero Atlantis C4-M



METAL



CÓDIGO	MEDIDA	€/100	
GPVD4162012	41 x 62 x 2,00	689,233	50

PSA-A

Perfil de aluminio con alas



METAL



CÓDIGO	MEDIDA	€/100	
PSAA0400	80 x 35 - L.400 mm	1.006,720	20
PSAA1250	80 x 35 - L.1250 mm	3.105,327	2
PSAA1875	80 x 35 - L.1875 mm	4.457,927	2
PSAA2500	80 x 35 - L.2500 mm	5.962,750	2
PSAA3625	80 x 35 - L.3625 mm	8.415,697	2
PSAA4400 NEW	80 x 35 - L.4400 mm	9.776,800	2
PSAA4800 NEW	80 x 35 - L.4800 mm	10.672,200	2

PSA-UN

Unión de aluminio para perfil PSA-A



METAL



CÓDIGO	MEDIDA	€/100	
PSAUN200	200	290,488	20

Perfiles, uniones, guías y empalmes para estructura de apoyo

ISF-PU

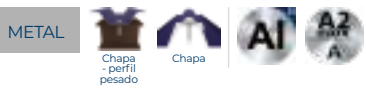

CÓDIGO	MEDIDA	€/PC	MEDIDA TORNILLO	
PSAUNT200	200	11,100	M5,5 x 19,0	1

PSA-UNT NEW

Unión de aluminio para perfil PSA-A con tornillo DIN-7504-K A2. Válido para guía PSA-A. Gültig für PSA-A Lochführung



Componentes. PSAUN200 x 2
ABE15519 x 8

CÓDIGO	MEDIDA	€/100	
PSAAV0150	90 x 75 - L. 150 mm	926,744	20



PSA-AV

Perfil de aluminio con alas para fijación directa discontinua en valle



CÓDIGO	MEDIDA	€/100	
PSEA601250	47 x 60 - L. 1250 mm	3.956,283	2
PSEA601875	47 x 60 - L. 1875 mm	5.842,287	2
PSEA602500	47 x 60 - L. 2500 mm	7.766,230	2
PSEA603625	47 x 60 - L. 3625 mm	11.169,717	2
PSEA604400 <small>NEW</small>	47 x 60 - L. 4400 mm	12.971,200	2
PSEA604800 <small>NEW</small>	47 x 60 - L. 4800 mm	14.084,400	2



PSE-A

Perfil de aluminio para fijación ensamblada





CÓDIGO	MEDIDA	€/100	
PSEUN060200	60 x 200	426,703	20

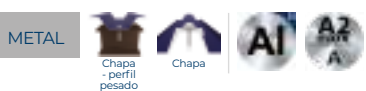

PSE-UN

Unión de aluminio para perfil PSE-A



CÓDIGO	MEDIDA	€/PC	MEDIDA TORNILLO	
PSEUNT60200	60 x 200	14,694	M 5,5 x 19,0	1

PSE-UNT NEW

Unión de aluminio para perfil PSE-A con tornillo DIN-7504-K A2



Componentes. PSEUN60200 x 2
ABE15519 x 8

ISF-PU

Perfiles, uniones, guías y empalmes para estructura de apoyo

PSE-C

Perfil de aluminio para fijación ensamblada lateral



CÓDIGO	MEDIDA	€/100	
PSEC410125	41 x 41 - L.125 mm	418,820	20
PSEC410200	41 x 41 - L.200 mm	589,513	20
PSEC411250	41 x 41 - L.1250 mm	2.902,063	2
PSEC411875	41 x 41 - L.1875 mm	4.166,273	2
PSEC412500	41 x 41 - L.2500 mm	5.572,777	2
PSEC413625	41 x 41 - L.3625 mm	7.786,350	2
PSEC414400 NEW	41 x 41 - L.4400 mm	9.002,400	2
PSEC414800 NEW	41 x 41 - L.4800 mm	9.873,600	2

NEW PSE-CB

Perfil de aluminio para fijación ensamblada lateral con cinta de estanqueidad de butileno



CÓDIGO	MEDIDA	€/100	
PSECB410125	41 x 41 - L.125 mm	570,847	20
PSECB410200	41 x 41 - L.200 mm	877,417	20

PSE-CUN

Unión de aluminio para perfil PSE-C

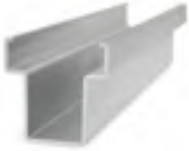

CÓDIGO	MEDIDA	€/100	
PSECUN200	200 mm	368,501	10

NEW PSE-CUNT

Unión de aluminio para perfil PSE-C con tornillo DIN-7504-K A2. Válido para guía PSE-C



CÓDIGO	MEDIDA	€/PC	MEDIDA TORNILLO		
PSECUNT200	200	10,130	5,5 x 19	1	20

Componentes: PSECUN200 x2
ABEIS519 x8

Conectores + Complementos para montaje de estructuras solares

ISF-CC

METAL



CÓDIGO	MEDIDA	€/100	LLAVE DE INSTALACIÓN		
6921108020	M8 x 20	50,523	13	200	2.400
6921108050	M8 x 50	80,817	13	100	600
6921108070	M8 x 70	117,303	13	100	600

DIN-6921 A2

Tornillo DIN-6921. Tornillo hexagonal con arandela estampada y grafilada. Inoxidable A2



METAL



CÓDIGO	MEDIDA	€/100		
D603108016	M8 x 16	42,047	200	2.400

DIN-603 A2

Tornillo DIN-603. Cabeza redonda y cuello cuadrado. Inoxidable A2



Disponible en varios recubrimientos. Consulte precio y plazo de entrega.

METAL



CÓDIGO	MEDIDA	€/100	LLAVE DE INSTALACIÓN	N° HUELLA		
D6923IM08	M8	24,660	13	13	250	3.000
D6923IM10	M10	47,753	15	17	250	3.000
D6923IM12	M12	70,740	18	19	250	1.500



DIN-6923 A2

Tuerca brida grafilada DIN-6923. Inoxidable A2



METAL



CÓDIGO	MEDIDA	€/100		
D127IM08	M8	4,530	200	9.000
D127IM10	M10	7,237	100	4.500
D127IM12	M12	10,923	100	4.500

DIN-127 A2

Arandela muelle grower DIN-127. Inoxidable A2



MULTIMATERIAL



CÓDIGO	MEDIDA	€/100		
TPGPXS	Perfil GP-XS	58,418	20	500
TPPSAA	Perfil PSA-A	58,418	20	500
TPPSEA	Perfil PSE-A	61,925	20	500
TPPSEC	Perfil PSE-C	58,418	20	500

TP-PS NEW

Tapa lateral para perfil solar



ISF-CC

Conectores + Complementos para montaje de estructuras solares

KFS-FI

Conector cruzado para fijación inferior. Inoxidable A2



METAL



CÓDIGO	MEDIDA	€/100		
KFSFI08	M8	141,570	100	900

KFS-FL

Conector cruzado para fijación lateral. Inoxidable A2



METAL



CÓDIGO	MEDIDA	€/100		
KFSFL08	M8	294,530	10	80

KFS-FC

Conector cruzado para fijación lateral. Perfil PSE-C



METAL



CÓDIGO	MEDIDA	€/100		
KFSFCM0820	8 x 20	183,920	10	80

TU-RX A2

Tuerca rápida INDEXTRUT. Inoxidable A2



METAL



CÓDIGO	MEDIDA	€/100		
TURXA208	M8	141,600	50	300

CL-CCS

Clip para conducción de cables. Simple



METAL



CÓDIGO	MEDIDA	€/100		
CLCCS0616	6-16	137,130	20	480

CL-SC

Clip para la sujeción de conexiones entre cables



METAL





CÓDIGO	MEDIDA	€/100		
CLSC1722	17-22	107,970	20	480

Conectores + Complementos para montaje de estructuras solares

ISF-CC

METAL



CÓDIGO	MEDIDA	€/100		
CLTT01	1	401,100	20	900



CL-TT NEW

Clip para cable de toma tierra sin tornillos



METAL



CÓDIGO	MEDIDA	€/100		
CLEX01	350 x 80 x 40	668,400	1	12



CL-EX NEW

Herramienta de extracción para clips de fijación solar CL



METAL



CÓDIGO	MEDIDA	€/100		
CLPG4120	20 mm	41,690	10	120



CL-PG NEW

Goma de separación entre paneles para clip CL-GS



MACIZOS



CÓDIGO	MEDIDA	€/PC		
BBISDS10210	Ø10 x 210	14,617	1	50
BBISDS16400	Ø16 x 400	43,560	1	25

BBI-SDS NEW

Broca SDS-Plus de bajo impacto



METAL

CÓDIGO	MEDIDA	€/100	
BOCAL007	7 mm	1.045,440	5
BOCAL009	9 mm	1.121,472	5

BOCA-L NEW

Boca hexagonal larga





ISF-TR

Triángulos para instalación de placas solares

TPA-R

Triángulo regulable de aluminio premontado. Válido para perfil PSE-A



METAL



CÓDIGO	MEDIDA	€/PC	
TPAR251500	25° / 30° / 35° - L.1500 mm	64,947	4

TPA-P

Perfil riostra para triángulo de aluminio premontado



METAL



CÓDIGO	MEDIDA	€/100	
TPAP352000	35 x 35 - L.2000 mm	1.842,760	2

TRP-XS

Triángulo regulable premontado INDEXTRUT. Acero con recubrimiento Atlantis C4-M. Válido para guía GP-XS



METAL



CÓDIGO	MEDIDA	€/PC	
TRPXS412515	25° - 35° - L.1500 mm	56,582	4

NEW TPA-A

Triángulo abierto de aluminio premontado. Válido para guías PSE-C y PSE-A



METAL



CÓDIGO	MEDIDA	€/PC	
TPAA301230	30° - L.1230 mm	5.904,296	4
TPAA301750	30° - L.1750 mm	7.555,694	4
TPAA301230	30° - L.1230 mm	5.904,296	4
TPAA301750	30° - L.1750 mm	7.555,694	4

NEW TPA-C

Triángulo cerrado de aluminio premontado. Válido para guías PSE-C y PSE-A



METAL





CÓDIGO	MEDIDA	€/PC	
TPAC151230	15° - L.1230 mm	7.562,500	4
TPAC151750	15° - L.1750 mm	9.831,250	4
TPAC301230	30° - L.1230 mm	7.562,500	4
TPAC301750	30° - L.1750 mm	9.831,250	4

Triángulos para instalación de placas solares

ISF-TR

METAL



CÓDIGO	MEDIDA	€/100		
NUXSM0841	MB	732,827	10	100

NU-XS

Nudo articulado INDEXTRUT. Acero con recubrimiento Atlantis C4-M. Válido para guías PSE-C y PSE-A





Accesorios regulables para la instalación de placas solares

ISF-FR

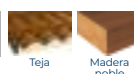
METAL



CÓDIGO	MEDIDA	€/100	LLAVE DE INSTALACIÓN		
KFSMA10200	10 x 200	509,034	7	25	150
KFSMA102002 NEW	10 x 200	559,936	7	2	-
KFSMA102010 NEW	10 x 200	534,485	7	10	40
KFSMA10250	10 x 250	529,474	7	25	150
KFSMA102502 NEW	10 x 250	580,186	7	2	-
KFSMA102510 NEW	10 x 250	563,921	7	10	20
KFSMA12300	12 x 300	1.113,006	9	25	75
KFSMA12350	12 x 350	1.321,193	9	25	75

KFS-MA

Espárrago doble rosca. Inoxidable A2



METAL

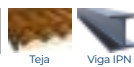

CÓDIGO	MEDIDA	€/100	LLAVE DE INSTALACIÓN		
KFSAU10160	10 x 160	2.071,968	13	25	150
KFSAU10200	10 x 200	2.404,101	13	25	75

KFS-AU

Kit tornillo autorroscante. Inoxidable A2



METAL

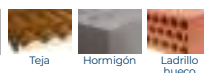

CÓDIGO	MEDIDA	€/100	LLAVE DE INSTALACIÓN		
KFSRV10250	10 x 250	529,474	7	25	150
KFSRV12350	12 x 350	1.228,877	9	25	75

KFS-RV

Varilla roscada para instalación con anclaje químico. Inoxidable A2





ISF-FR

Accesorios regulables para la instalación de placas solares

GS-TC

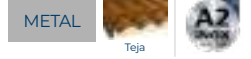
Gancho salvateja ajustable para teja curva. Inoxidable A2



CÓDIGO	MEDIDA	€/100	
GSTC040080	40 - 80	2.419,966	20
GSTC040801 NEW	40 - 80	2.782,962	1
GSTC040810 NEW	40 - 80	2.589,366	10
GSTC080120	80 - 120	2.465,763	20
GSTC081201 NEW	80 - 120	2.835,630	1
GSTC081210 NEW	80 - 120	2.638,369	10

GS-TU

Gancho salvateja ajustable para teja universal. Inoxidable A2



CÓDIGO	MEDIDA	€/100	
GSTU040055	40 - 55	2.614,391	20
GSTU040501 NEW	40 - 55	3.006,549	1
GSTU040510 NEW	40 - 55	2.797,398	10

NEW GS-TP

Gancho salvateja para teja plana. Inoxidable A2

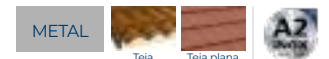

CÓDIGO	MEDIDA	€/100	
GSTP075100	75 - 100	1.427,800	20
GSTP120145	120 - 145	1.903,733	20

NEW GS-PI

Gancho salvateja para teja de pizarra. Inoxidable A2



CÓDIGO	MEDIDA	€/100	
GSPI040065	40 - 65	1.308,817	20
GSPI090115	90 - 115	1.856,140	20

STR

Soporte regulable para perfil trapecoidal. Inoxidable A2





CÓDIGO	MEDIDA	€/100	
STR1680	16 - 80	1.769,204	40

Accesorios regulables para la instalación de placas solares

ISF-FR

METAL



CÓDIGO	MEDIDA	€/100		
PMO1012	M10 - M12	263,027	25	300

PMO

Placa para tornillo doble rosca. Inoxidable A2



METAL



CÓDIGO	MEDIDA	€/100	
PMOD101202	M10 - M12	412,333	2
PMOD101210	M10 - M12	352,667	10

PMO-D NEW

Placa para tornillo doble rosca con tornillo DIN-603 A2 y tuerca DIN-6923 A2



Componentes. PMO1012 x1
D603I08016 x1
D6923I08 x1

METAL



CÓDIGO	MEDIDA	€/100	
PMOK101202	M10 - M12	525,000	2
PMOK101210	M10 - M12	449,333	10

PMO-K NEW

Placa para tornillo doble rosca con conector cruzado para fijación inferior. Inoxidable A2



Componentes. PMO1012 x1
KFSFIM08 x1

METAL



CÓDIGO	MEDIDA	€/100		
PMOL1012	M10 - M12	156,117	25	300

PMO-L

Pletina en "L" de aluminio para fijación lateral. Válida para perfil PSE-C



METAL



CÓDIGO	MEDIDA	€/100	
PMOLK101202	M10 - M12	379,764	2
PMOLK101210	M10 - M12	325,116	10

PMO-LK NEW

Pletina en "L" de aluminio para fijación lateral con conector cruzado para fijación inferior. Válida para perfil PSE-C



Componentes. PMO1012 x1
KFSFIM08 x1

ISF-FR



Accesorios regulables para la instalación de placas solares

MO-TL

Tamiz largo recortable para fijación en cubierta teja + rasillón

QUÍMICOS



CÓDIGO	MEDIDA	€/100		
MOTL16330	16 x 330	178,637	10	500

MO-PC

Extensor de cánula para fijaciones químicas

QUÍMICOS



CÓDIGO	MEDIDA	€/PC	PCS. X BOTE		
MOPC185	185 mm	3,587	12	1	20

ISF-FD



Accesorios de fijación directa para la instalación de placas solares

DIN-7504-K RE NI + ARVUL

Tornillo autotaladrante punta reducida Atlantis C4-M + Arandela vulcanizada EPDM-inoxidable A2

METAL



CÓDIGO	MEDIDA	€/100			
ARENI166325	6,25 x 25 P-16	30,039	8	500	3.000



NEW PST 3 + ARVUL A2

Tornillo con punta broca estándar #3 con recubrimiento ATLANTIS C4-M y arandela inoxidable A2

METAL



CÓDIGO	MEDIDA	€/100		ESPESOR MÁX. A FIJAR (MM)	CAPACIDAD DE TALADRO		
PST1655060	5,5 / 6,3 x 60 P16	56,360	8	31 - 45	1,50-6,00	100	1.200
PST1655082	5,5 / 6,3 x 82 P16	66,557	8	43 - 67	1,50-6,00	100	600
PST1655098	5,5 / 6,3 x 98 P16	72,273	8	54 - 83	1,50-6,00	100	600
PST1655115	5,5 / 6,3 x 115 P16	86,140	8	56 - 100	1,50-6,00	100	600





NEW PST 5 + ARVUL A2

Tornillo con punta broca extra larga #5 con recubrimiento ATLANTIS C4-M y arandela inoxidable A2

METAL



CÓDIGO	MEDIDA	€/100		ESPESOR MÁX. A FIJAR (MM)	CAPACIDAD DE TALADRO		
PSTL1655075	5,5 / 6,3 x 75 P16	63,827	8	33 - 60	6,00-12,00	100	1.200
PSTL1655085	5,5 / 6,3 x 85 P16	70,980	8	38 - 70	6,00-12,00	100	600
PSTL1655105	5,5 / 6,3 x 105 P16	87,957	8	48 - 90	6,00-12,00	100	600
PSTL1655130	5,5 / 6,3 x 130 P16	114,480	8	63 - 115	6,00-12,00	100	600



Accesorios de fijación directa para la instalación de placas solares

ISF-FD





CÓDIGO	MEDIDA	€/100	Nº HUELLA		
TACN165525	5,5 x 25 P16	38,211	8	500	2.000

TAC + ARVUL

Tornillo de cosido Atlantis C4-M + Arandela vulcanizada EPDM



CÓDIGO	MEDIDA	€/100	Nº HUELLA		
TACB166025	6 x 25 P16	92,799	8	500	2.000

TAC BIMETAL + ARVUL A2

Tornillo de cosido Bimetal + Arandela vulcanizada EPDM-inoxidable A2



CÓDIGO	MEDIDA	€/100	Ø BROCA		
RETE5220	5,2 x 20	92,842	5,3	250	3.000

RE-TE

Remache trebol estanco + Arandela vulcanizada EPDM



CÓDIGO	MEDIDA	€/100		
AUEN1166325	6,25 x 25 P-16	35,340	500	2.000

AUE NI + ARVUL

Tornillo autorroscante Atlantis C4-M + Arandela vulcanizada EPDM-inoxidable A2



ISF-ES

Accesorios de estanqueidad para la instalación de placas solares

ARS-P

Arandela paraguas inoxidable A2 + EPDM



METAL



CÓDIGO	MEDIDA	€/100		
ARSP08	M8	47,727	100	1.200
ARSP10	M10	47,727	100	1.200

ARS-S

Arandela para tornillo doble rosca



METAL



CÓDIGO	MEDIDA	€/100		
ARSS10	M10	23,623	100	1.200
ARSS12	M12	23,623	100	1.200

CS-B

Cinta de estanqueidad de butileno



METAL



CÓDIGO	MEDIDA	€/PC		
CSB0104010	40 x 1 - L.10	20,623	1	27
CSB0108010	80 x 1 - L.10	40,300	1	18

MS-IS

Membrana impermeabilizante híbrida líquida multiusos de alta elasticidad, basada en tecnología W-PROTEK



QUÍMICOS



Hormigón



Cerámica



Madera noble



Fibrocemento



Teja



Perfiles de aluminio



Ladrillo de adobe



Ladrillo macizo

CÓDIGO	MEDIDA	COLOR	€/PC		
MSISG01	1 kg. (Gris)	GRIS	37,623	1	6
MSISG05	5 kg. (Gris)	GRIS	152,473	1	6
MSIST01	1 kg. (Terracota)	TERRACOTA	37,623	1	6
MSIST05	5 kg. (Terracota)	TERRACOTA	152,473	1	6



Kits para instalaciones solares

ISF-KT



KC-PSA

Coplanar con perfil con alas de aluminio (PSA-A). Fijación directa



CÓDIGO	MEDIDA	€/PC	
KCPSA0230	x2 (30 mm) - ORIGEN	182,758	1
KCPSA0235	x2 (35 mm) - ORIGEN	182,758	1
KCPSA0240	x2 (40 mm) - ORIGEN	182,758	1
KCPSA02AM	x2 - AMPLIACION	175,015	1
KCPSA0330	x3 (30 mm) - ORIGEN	254,004	1
KCPSA0335	x3 (35 mm) - ORIGEN	254,004	1
KCPSA0340	x3 (40 mm) - ORIGEN	254,004	1
KCPSA03AM	x3 - AMPLIACION	244,711	1



KC-PSD

Coplanar con perfil con alas de aluminio (PSA-A). Fijación directa formato de perfil discontinuo



CÓDIGO	MEDIDA	€/PC	
KCPSD01AM	x1 - AMPLIACION	42,689	1
KCPSD0130	x1 (30 mm) - ORIGEN	85,378	1
KCPSD0135	x1 (35 mm) - ORIGEN	85,378	1
KCPSD0140	x1 (40 mm) - ORIGEN	85,378	1



KC-PSC

Coplanar con perfil de aluminio PSE-C. Fijación ensamblada lateral



CÓDIGO	MEDIDA	€/PC	
KCPSC0230	x2 (30 mm) - ORIGEN	176,563	1
KCPSC0235	x2 (35 mm) - ORIGEN	176,563	1
KCPSC0240	x2 (40 mm) - ORIGEN	176,563	1
KCPSC02AM	x2 - AMPLIACION	165,598	1
KCPSC0330	x3 (30 mm) - ORIGEN	240,730	1
KCPSC0335	x3 (35 mm) - ORIGEN	240,730	1
KCPSC0340	x3 (40 mm) - ORIGEN	240,730	1
KCPSC03AM	x3 - AMPLIACION	230,772	1



KC-GPX

Coplanar con guía perforada acero Atlantis C4-M INDEXTRUT SOLAR GP-XS



CÓDIGO	MEDIDA	€/PC	
KCGPX0230	x2 (30 mm) - ORIGEN	154,000	1
KCGPX0235	x2 (35 mm) - ORIGEN	154,000	1
KCGPX0240	x2 (40 mm) - ORIGEN	154,000	1
KCGPX02AM	x2 - AMPLIACION	148,830	1
KCGPX0330	x3 (30 mm) - ORIGEN	210,540	1
KCGPX0335	x3 (35 mm) - ORIGEN	210,540	1
KCGPX0340	x3 (40 mm) - ORIGEN	210,540	1
KCGPX03AM	x3 - AMPLIACION	205,333	1



ISF-KT

Kits para instalaciones solares

KC-GPD

Coplanar con guía perforada Atlantis C4-M INDEXTRUT SOLAR GP-XS. Formato guía discontinua



METAL



CÓDIGO	MEDIDA	€/PC	
KCGPD01AM	x1 - AMPLIACION	24,384	1
KCGPD0130	x1 (30 mm) - ORIGEN	52,250	1
KCGPD0135	x1 (35 mm) - ORIGEN	52,250	1
KCGPD0140	x1 (40 mm) - ORIGEN	52,250	1

KT-PSE

Triangular con perfil de aluminio PSE-A. Fijación ensamblada



METAL



CÓDIGO	MEDIDA	€/PC	
KTPSE0230	x2 (30 mm) - ORIGEN	365,517	1
KTPSE0235	x2 (35 mm) - ORIGEN	365,517	1
KTPSE0240	x2 (40 mm) - ORIGEN	365,517	1
KTPSE02AM	x2 - AMPLIACION	360,871	1
KTPSE0330	x3 (30 mm) - ORIGEN	520,397	1
KTPSE0335	x3 (35 mm) - ORIGEN	520,397	1
KTPSE0340	x3 (40 mm) - ORIGEN	520,397	1
KTPSE03AM	x3 - AMPLIACION	508,006	1

NEW

KT-PSC

Triangular con perfil de aluminio PSE-C. Fijación ensamblada



METAL



CÓDIGO	MEDIDA	€/PC	
KTPSC0230	x2 (30 mm) - ORIGEN	316,884	1
KTPSC0235	x2 (35 mm) - ORIGEN	316,884	1
KTPSC0240	x2 (40 mm) - ORIGEN	316,884	1
KTPSC02AM	x2 - AMPLIACION	309,683	1
KTPSC0330	x3 (30 mm) - ORIGEN	439,317	1
KTPSC0335	x3 (35 mm) - ORIGEN	439,317	1
KTPSC0340	x3 (40 mm) - ORIGEN	439,317	1
KTPSC03AM	x3 - AMPLIACION	432,115	1

KT-GPX

Triangular con guía perforada Atlantis C4-M INDEXTRUT SOLAR GP-XS



METAL

CÓDIGO	MEDIDA	€/PC	
KTGPX0230	x2 (30 mm) - ORIGEN	274,032	1
KTGPX0235	x2 (35 mm) - ORIGEN	274,032	1
KTGPX0240	x2 (40 mm) - ORIGEN	274,032	1
KTGPX02AM	x2 - AMPLIACION	266,112	1
KTGPX0330	x3 (30 mm) - ORIGEN	392,832	1
KTGPX0335	x3 (35 mm) - ORIGEN	392,832	1
KTGPX0340	x3 (40 mm) - ORIGEN	392,832	1
KTGPX03AM	x3 - AMPLIACION	386,496	1



SISTEMAS DE FIJACIÓN RÁPIDA EN VIGA



SU

Sistemas de fijación rápida en viga

SU-MO

Mordaza para viga



 *Info. Técnica*
P. 431

METAL



CÓDIGO	MEDIDA	€/100	ANCHO MÁX. A LA VIGA		
SUMOM06	ROSCADO M6	338,307	20	50	200
SUMOM08	ROSCADO M8	363,639	20	50	200
SUMOP09	PASANTE Ø9	363,639	20	50	200
SUMOM10	ROSCADO M10	424,970	20	50	150
SUMOP11	PASANTE Ø11	424,970	20	50	150
SUMOM12	ROSCADO M12	659,773	25	50	-
SUMOP13	PASANTE Ø13	659,773	25	50	100

SU-CL



Clip de suspensión



 *Info. Técnica*
P. 431

METAL



CÓDIGO	MEDIDA	€/100	LONGITUD MIN. ALA VIGA		
SUCL02	6.3	38,962	14	100	1.200
SUCL04	6.3	55,177	23	100	400
SUCL10	6.3	64,260	23	100	300
SUCL15	6.3	87,390	23	100	300

SU-VA



Clip varilla



 *Info. Técnica*
P. 431

METAL





CÓDIGO	MEDIDA	€/100	LONGITUD MIN. ALA VIGA		
SUVA0602	M6	99,043	14	100	300
SUVA0802	M8	99,043	14	100	300
SUVA0604	M6	121,857	23	100	200
SUVA0804	M8	121,857	23	100	200
SUVA0610	M6	172,149	23	100	-
SUVA0810	M8	172,149	23	100	200
SUVA0615	M6	207,771	23	100	-
SUVA0815	M8	207,771	23	100	-

Sistemas de fijación rápida en viga

SU

02 Info. Técnica
p. 432



CÓDIGO	MEDIDA	€/100		
SUCU0602	M6	99,483	100	300
SUCU0605	M6	109,464	100	300
SUCU0606	M6	138,413	100	200
SUCU0607	M6	163,147	100	200

SU-CU

Clip de cuelgue



02 Info. Técnica
p. 432



CÓDIGO	MEDIDA	€/100	MEDIDA TORNILLO	ESPESOR MÁX. A FIJAR (MM)	ANCHO MÁX. A LA VIGA		
SUAB0603	M6	94,023	M6 x 9	3 - 7	3 - 7	100	300
SUAB0607	M6	94,397	M6 x 9	7 - 13	7 - 13	100	200
SUAB0614	M6	98,353	M6 x 9	14 - 20	14 - 20	100	200



SU-AB

Clip de viga para abrazadera



02 Info. Técnica
p. 432



CÓDIGO	MEDIDA	€/100	ESPESOR MÁX. A FIJAR (MM)		
SUCA0602	6-7	32,513	1 - 4	100	2.400
SUCA0604	6-7	33,260	4 - 7,5	100	1.200
SUCA0607	6-7	33,777	7,5 - 12	100	1.200
SUCA0802	8-9	33,887	1 - 4	100	1.200
SUCA0804	8-9	34,407	4 - 7,5	100	1.200
SUCA0807	8-9	34,840	7,5 - 12	100	1.200
SUCA1002	10-11	34,567	1 - 4	100	1.200
SUCA1004	10-11	35,100	4 - 7,5	100	1.200
SUCA1007	10-11	35,563	7,5 - 12	100	1.200
SUCA1202	12-14	35,387	1 - 4	100	1.200
SUCA1204	12-14	35,900	4 - 7,5	100	1.200
SUCA1207	12-14	36,033	7,5 - 12	100	1.200
SUCA1502	15-18	36,157	1 - 4	100	1.200
SUCA1504	15-18	36,933	4 - 7,5	100	1.200
SUCA1507	15-18	37,083	7,5 - 12	100	1.200
SUCA1902	19-24	36,997	1 - 4	100	1.200
SUCA1904	19-24	44,830	4 - 7,5	100	600
SUCA1907	19-24	45,700	7,5 - 12	100	600
SUCA2502	25-30	46,080	1 - 4	100	600
SUCA2504	25-30	51,403	4 - 7,5	100	600
SUCA2507	25-30	56,287	7,5 - 12	100	600

SU-CA

Clip de viga para cable





VARILLA ROSCADA Y ACCESORIOS DE FIJACIÓN



RV

Varilla roscada

RV-ZN

Zincada. 1 metro

METAL



CÓDIGO	MEDIDA	€/100	PASO	
975ZM04	M4 x 1000	124,025	0.7	100
975ZM05	M5 x 1000	183,116	0.8	100
975ZM06	M6 x 1000	170,063	1	100
975ZM08	M8 x 1000	274,050	1.25	50
975ZM10	M10 x 1000	427,334	1.5	25
975ZM12	M12 x 1000	635,238	1.75	20
975ZM14	M14 x 1000	956,009	2	10
975ZM16	M16 x 1000	1.321,788	2	10
975ZM18	M18 x 1000	1.652,284	2.5	10
975ZM20	M20 x 1000	2.035,196	2.5	5
975ZM22	M22 x 1000	2.976,584	2.5	5
975ZM24	M24 x 1000	3.238,888	3	5
975ZM27	M27 x 1000	4.097,934	3	5
975ZM30	M30 x 1000	5.130,471	3.5	5
975ZM33	M33 x 1000	6.313,225	3.5	3
975ZM36	M36 x 1000	9.123,459	4	3

RV-ZN 8.8

Zincada. Calidad 8.8. 1 metro

METAL



CÓDIGO	MEDIDA	€/100	PASO	
9758ZM05	M5 x 1000	266,259	0.8	100
9758ZM06	M6 x 1000	253,571	1	100
9758ZM08	M8 x 1000	451,679	1.25	50
9758ZM10	M10 x 1000	700,188	1.5	25
9758ZM12	M12 x 1000	966,021	1.75	20
9758ZM14	M14 x 1000	1.393,859	2	10
9758ZM16	M16 x 1000	1.821,416	2	10
9758ZM18	M18 x 1000	2.308,613	2.5	5
9758ZM20	M20 x 1000	2.984,266	2.5	5
9758ZM22	M22 x 1000	3.938,016	2.5	5
9758ZM24	M24 x 1000	4.210,929	3	5
9758ZM27	M27 x 1000	5.487,954	3	5
9758ZM30	M30 x 1000	7.302,359	3.5	5
9758ZM33	M33 x 1000	9.280,446	3.5	3
9758ZM36	M36 x 1000	12.018,084	4	3

RV-A2

Inoxidable A2. 1 metro

INOXIDABLE



CÓDIGO	MEDIDA	€/100	PASO	
975A2M04	M4 x 1000	359,840	0.7	1
975A2M05	M5 x 1000	424,307	0.8	1
975A2M06	M6 x 1000	585,823	1	1
975A2M08	M8 x 1000	950,680	1.25	1
975A2M10	M10 x 1000	1.377,197	1.5	1
975A2M12	M12 x 1000	2.096,627	1.75	1
975A2M14	M14 x 1000	3.671,453	2	1
975A2M16	M16 x 1000	4.239,507	2	1
975A2M18	M18 x 1000	4.624,917	2.5	1
975A2M20	M20 x 1000	6.382,387	2.5	1
975A2M22	M22 x 1000	7.460,763	2.5	1
975A2M24	M24 x 1000	10.070,977	3	1
975A2M27	M27 x 1000	12.137,603	3	1
975A2M30	M30 x 1000	18.890,203	3.5	1
975A2M33	M33 x 1000	23.715,537	3.5	1
975A2M36	M36 x 1000	27.276,713	4	1



Varilla roscada

RV

METAL



RV-2M

Zincada. 2 metros

CÓDIGO	MEDIDA	€/100	PASO	
975ZM2M06	M6 x 2.000	340,121	1	50
975ZM2M08 NEW	M8 x 2.000	548,100	1.25	25
975ZM2M10 NEW	M10 x 2.000	854,666	1.5	20



Espárrago separador

VR-SE

METAL



CÓDIGO	MEDIDA	€/100		
VRSE06020	M6 x 20	12,873	200	4,800
VRSE06030	M6 x 30	18,103	200	4,800
VRSE08020	M8 x 20	17,476	200	3,200
VRSE08030	M8 x 30	22,547	200	2,400
VRSE10030	M10 x 30	34,368	200	2,400
VRSE12030	M12 x 35	72,389	100	800



Manguito de unión

MA

METAL



MA-HE

Hexagonal

CÓDIGO	MEDIDA	€/100		
MAE0620	M6 x 20	18,587	200	2,400
MAE0630	M6 x 30	26,953	200	1,600
MAE0825	M8 x 25	21,830	200	1,600
MAE1030	M10 x 30	29,944	150	900
MAE1235	M12 x 35	67,103	100	600
MAE1650	M16 x 50	188,404	50	100
MAE2060	M20 x 60	477,990	25	-



Blíster

Caja ventana

CÓDIGO	MEDIDA	€/BOLSA	PCS	BOLSAS
BZMAE0630	M6 x 30	2,582	6	15
BZMAE0825	M8 x 25	2,582	6	15
BZMAE1030	M10 x 30	2,582	4	15

CÓDIGO	MEDIDA	€/CAJA	PCS	CAJAS
VMAE0630	M6 x 30	7,094	20	8
VMAE0825	M8 x 25	5,726	20	8
VMAE1030	M10 x 30	6,187	15	8

METAL



MA-RE

Redondo

CÓDIGO	MEDIDA	€/100		
MAR0420	M4 x 20	17,207	200	4,800
MAR5322	5/32W x 20	25,643	200	4,800
MAR0620	M6 x 20	17,247	200	2,400
MAR0630	M6 x 30	25,617	200	1,600
MAR0825	M8 x 25	21,830	200	2,400
MAR0830	M8 x 30	25,720	200	1,600
MAR1030	M10 x 30	29,787	150	900
MAR1235	M12 x 35	50,330	100	600
MAR1650	M16 x 50	179,630	50	300



Caja ventana

CÓDIGO	MEDIDA	€/CAJA	PCS	CAJAS
VMAR0420	M4 x 20	5,471	25	8
VMAR0630	M6 x 30	6,861	20	8
VMAR0830	M8 x 30	6,748	20	8
VMAR1030	M10 x 30	5,789	15	8

MA

Manguito de unión

MA-RI

Redondo. Inoxidable A2



INOXIDABLE



CÓDIGO	MEDIDA	€/100		
MARI0830	M8 x 30	204,683	100	2.400
MARI1030	M10 x 30	281,790	100	-

MA-MH

Separador macho-hembra especial para cuadros eléctricos



METAL



CÓDIGO	MEDIDA	€/100		
MAMH0610	M6 x 10	44,927	100	3.000
MAMH0620	M6 x 20	55,247	100	1.200
MAMH0630	M6 x 30	88,027	100	1.200
MAMH0640	M6 x 40	102,153	100	1.000
MAMH0650	M6 x 50	114,210	50	1.000

AR-FO

Argolla forjada



METAL



CÓDIGO	MEDIDA	€/100	LONGITUD DE LA ROSCA	Ø OJO		
ARFOM06Z	M6 x 55	81,027	55	10	100	1.200
ARFOM08Z	M8 x 60	108,623	60	11.8	100	600
ARFOM10Z	M10 x 73	153,213	73	14.5	50	300
ARFOM12Z	M12 x 90	295,803	90	17	50	200
ARFOM16Z	M16 x 95	666,417	95	23.5	25	50

GA-FO

Gancho forjado



METAL



CÓDIGO	MEDIDA	€/100	LONGITUD DE LA ROSCA	APERTURA GANCHO		
GAFOM06Z	M6 x 55	74,687	55	8	100	1.200
GAFOM08Z	M8 x 60	122,840	60	10	100	600
GAFOM10Z	M10 x 73	201,100	73	12.5	50	300
GAFOM12Z	M12 x 90	349,063	90	16	50	100
GAFOM16Z	M16 x 95	693,717	95	19	25	50

Tirafondo abrazadera y grapa

TAG

02
P. 432
Info
Técnica

SANEAMIENTO



CÓDIGO	MEDIDA	€/100		
ABTA0630	M6 x 30	6,192	100	4,500
ABTA0640	M6 x 40	7,592	100	2,400
ABTA0650	M6 x 50	8,752	100	2,400
ABTA0730	M7 x 30	6,192	100	2,400
ABTA0740	M7 x 40	7,592	100	2,400
ABTA0750	M7 x 50	8,752	100	2,400
ABTA0760	M7 x 60	14,344	100	1,200
ABTA0770	M7 x 70	19,960	100	1,200
ABTA0780	M7 x 80	21,632	100	1,200
ABTA0840	M8 x 40	10,856	100	2,400
ABTA0860	M8 x 60	14,344	100	1,200
ABTA0880	M8 x 80	21,632	100	1,200
ABTA1050	M10 x 50	24,120	100	1,200
ABTA1070	M10 x 70	30,824	100	800
ABTA1090	M10 x 90	40,368	100	600

AB-TA

Zincado. Ranurado



02
P. 433
Info
Técnica

SANEAMIENTO



CÓDIGO	MEDIDA	€/100		
ABTAB0630	M6 x 30	6,192	100	4,500
ABTAB0640	M6 x 40	7,592	100	2,400
ABTAB0650	M6 x 50	8,752	100	2,400

AB-TA B

Bicromatado. Ranurado



02
P. 433
Info
Técnica

INOXIDABLE



CÓDIGO	MEDIDA	€/100		
ABTA20630	M6 x 30	84,600	100	2,400

AB-TA A2

Inoxidable A2



02
P. 433
Info
Técnica

SANEAMIENTO



CÓDIGO	MEDIDA	€/100		
ABTR05030	M5 x 30	10,850	100	2,400
ABTR05040	M5 x 40	11,237	100	2,400
ABTR05050	M5 x 50	12,523	100	2,400
ABTR05060	M5 x 60	14,837	100	1,200
ABTR06040	M6 x 40	14,337	100	2,400
ABTR06050	M6 x 50	17,387	100	1,200
ABTR06060	M6 x 60	19,967	100	1,200

AB-TR

Tornillo doble para abrazaderas

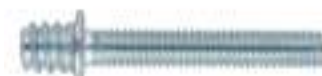

TAG

Tirafondo abrazadera y grapa

AB-PM7

Prolongador cilíndrico para abrazaderas M7



SANEAMIENTO



CÓDIGO	MEDIDA	€/100		
ABPM720	20	112,693	50	2.250
ABPM730	30	147,677	50	2.250
ABPM740	40	166,307	50	1.200

AB-TG

Tirafondo grapa. Huella combi



SANEAMIENTO



CÓDIGO	MEDIDA	€/100		UD. MIN. VENTA		
ABTG4530	4,5 x 30	7,477	PZ2	200	100	4.500
ABTG4535	4,5 x 35	7,957	PZ2	200	100	4.500
ABTG4540	4,5 x 40	8,287	PZ2	200	100	2.400
ABTG5030	5 x 30	9,389	PZ3	200	100	2.400
ABTG5040	5 x 40	9,940	PZ3	200	100	2.400

TM-VR

Tornillo manguito para varilla roscada



SANEAMIENTO



CÓDIGO	MEDIDA	€/100		
TMVR06065	M6-Ø6 x 65	159,717	50	1.200
TMVR07065	M7-Ø6 x 65	167,330	50	1.200
TMVR08065	M8-Ø6 x 65	170,723	50	1.200



Espárrago de doble rosca

ES-DR



SANEAMIENTO



ES-DR

Zincado. TX

CÓDIGO	MEDIDA	€/100	LLAVE DE INSTALACIÓN		
ESDR06040	M6 x 40	12,504	-	100	3.000
ESDR06050	M6 x 50	14,912	-	100	2.400
ESDR06060	M6 x 60	17,216	-	100	2.400
ESDR06070	M6 x 70	20,136	-	100	1.600
ESDR06080	M6 x 80	22,536	-	100	1.600
ESDR08050	M8 x 50	16,068	-	100	1.600
ESDR08060	M8 x 60	17,952	-	100	800
ESDR08070	M8 x 70	21,688	-	100	800
ESDR08080	M8 x 80	23,076	6	100	800
ESDR08090	M8 x 90	27,724	6	100	800
ESDR08100	M8 x 100	28,536	6	100	800
ESDR08110	M8 x 110	32,264	6	100	800
ESDR08120	M8 x 120	40,436	6	100	800
ESDR08130	M8 x 130	47,236	6	100	800
ESDR10080	M10 x 80	38,92	8	100	800
ESDR10100	M10 x 100	46,744	8	100	400
ESDR10110	M10 x 110	52,084	8	100	400
ESDR10120	M10 x 120	63,120	8	100	400
ESDR10130	M10 x 130	84,120	8	100	400
ESDR10140	M10 x 140	88,664	8	100	400
ESDR10150	M10 x 150	93,828	8	100	400
ESDR10180	M10 x 180	129,384	8	100	300
ESDR10200	M10 x 200	143,840	8	100	200



INOXIDABLE



ES-DA2

Inoxidable A2. TX

CÓDIGO	MEDIDA	€/100	LLAVE DE INSTALACIÓN		
ESDA208060	M8 x 60	123,333	6	100	800
ESDA210060	M10 x 60	208,583	8	100	800



Florón para abrazaderas

AB-F

SANEAMIENTO



AB-FP

Florón plano para abrazaderas

CÓDIGO	MEDIDA	€/100		
ABFP25	25	7,023	100	2.400
ABFP32	32	10,330	100	2.400



SANEAMIENTO



AB-FC

Florón cónico para abrazaderas

CÓDIGO	MEDIDA	€/100		
ABFC09	9	11,393	100	2.400
ABFC14	14	17,757	100	1.200
ABFC19	19	28,317	100	1.200



PF

Pletina de fijación

PF-ZN

Zincada



METAL



CÓDIGO	MEDIDA	€/100		
PFZNM0800	M8	52,292	100	600
PFZNM0810	M8+M10	66,443	100	600
PFZNM1000	M10	63,920	100	600

PF-A4

Inoxidable A4



INOXIDABLE



CÓDIGO	MEDIDA	€/100		
PFA4M0800	M8	303,137	100	600
PFA4M0810	M8+M10	361,303	100	600
PFA4M1000	M10	346,320	100	600

ABE-R

Tornillo punta broca con rosca macho y accesorios

ABE-RM

Tornillo punta broca. Rosca macho



METAL



CÓDIGO	MEDIDA	€/100		
ABERM06006	M6 x 5	60,510	200	2.400
ABERM08010	M8 x 10	89,787	100	1.200
ABERM08015	M8 x 15	97,440	100	1.200

ABE-BO

Boca hexagonal para el ABE-RM



METAL

CÓDIGO	MEDIDA	€/100		
ABEBO10	10 mm.	1.466,667	5	150
ABEBO13	13 mm.	1.466,667	5	150



FIJACIÓN PARA SANITARIOS Y CLIMATIZACIÓN



RA

Soportes para radiadores de aluminio

RA-TRG

Soporte triangular regulable con goma antivibraciones. 2 PCS x KIT



SANEAMIENTO

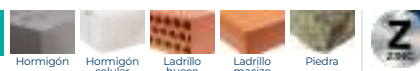

CÓDIGO	MEDIDA	€/KIT	KITS x
RATRG095	95	4,371	50

TAMBIÉN DISPONIBLE EN
easykits



RA-TRI

Soporte triangular 1°



SANEAMIENTO

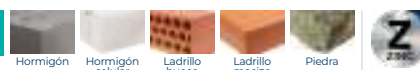

CÓDIGO	MEDIDA	€/100	KITS x
RATRI095	95	135,550	100

RA-FRE

Soporte ferrolí recto. 2 PCS x KIT



SANEAMIENTO



CÓDIGO	MEDIDA	€/KIT	KITS x
RAFRE095	95	4,329	50

RA-FIN

Soporte ferrolí inclinado. 2 PCS x KIT



SANEAMIENTO

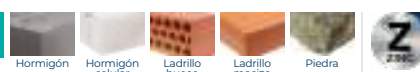

CÓDIGO	MEDIDA	€/KIT	KITS x
RAFIN100	100	4,486	50



Soportes para radiadores de aluminio

RA

SANEAMIENTO

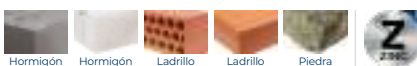

CÓDIGO	MEDIDA	€/KIT	KITS x 
RAR0100	100	6,952	50



RA-RO

Soporte Roca. 2 PCS x KIT



SANEAMIENTO

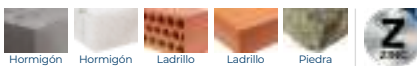

CÓDIGO	MEDIDA	€/100	KITS x 
RAFEM145	145	124,083	250
RAFEM175	175	133,036	250

RA-FEM

Soporte ferroli para empotrar



SANEAMIENTO

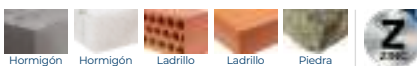

CÓDIGO	MEDIDA	€/100	KITS x 
RARAY032	32 x 78	101,564	250

RA-RAY

Soporte Rayco



SANEAMIENTO

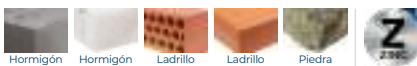

CÓDIGO	MEDIDA	€/100	KITS x 
RAPES032	32 x 78	110,514	250

RA-PES

Soporte de pestaña



22 KITS SOLUCIONES

easykits

AUMENTA LA VENTA CRUZADA
 PACKAGING MUY VISUAL Y ATRACTIVO
 INFORMACIÓN ÚTIL EN EL PACKAGING
 SOLUCIONES A PRODUCTOS HABITUALES

SA

Soportes de fijación para sanitarios

SA-LN

Fijación de lavabos con tuerca de nylon. 2 PCS x KIT



		SANEAMIENTO						Ny NYLON	Z ZINC
		Hormigón	Hormigón hueco	Ladrillo macizo	Hormigón celular	Ladrillo hueco	Piedra		
CÓDIGO	MEDIDA	€/KIT							KITS x
SALN08100	M8 x 100	2,205							50
SALN10120	M10 x 120	2,674							50



SA-LH

Fijación de lavabos con tuerca de hierro. 2 PCS x KIT



		SANEAMIENTO						Ny NYLON	Z ZINC
		Hormigón	Hormigón hueco	Ladrillo macizo	Hormigón celular	Ladrillo hueco	Piedra		
CÓDIGO	MEDIDA	€/KIT							KITS x
SALH08100	M8 x 100	2,202							100
SALH10120	M10 x 120	3,128							50



SA-IL

Fijación de WC y bidé con taco largo. 2 PCS x KIT



		SANEAMIENTO						A2 Acero	Ny NYLON
		Hormigón	Hormigón hueco	Ladrillo macizo	Hormigón celular	Ladrillo hueco	Piedra		
CÓDIGO	MEDIDA	€/KIT							KITS x
SAIL06080	M6 x 80	2,926							100

SA-WZ

Fijación WC y bidé, zincado. 2 PCS x KIT



		SANEAMIENTO						Ny NYLON	Z ZINC
		Hormigón	Hormigón hueco	Ladrillo macizo	Hormigón celular	Ladrillo hueco	Piedra		
CÓDIGO	MEDIDA	€/KIT							KITS x
SAWZ05080	M5 x 80	1,213							300



SA-WL

Fijación WC y bidé, latón. 2 PCS x KIT



		SANEAMIENTO						L LATÓN	Ny NYLON
		Hormigón	Hormigón hueco	Ladrillo macizo	Hormigón celular	Ladrillo hueco	Piedra		
CÓDIGO	MEDIDA	€/KIT							KITS x
SAWL05080	M5 x 80	3,091							100



Soportes de fijación para sanitarios

SA

SANEAMIENTO



CÓDIGO	MEDIDA	€/KIT	KITS x 
SACIO6080	M6 x 80	5,727	100

TAMBIÉN DISPONIBLE EN
easykits

SA-CI

Fijación de cisterna. 2 PCS x KIT



SANEAMIENTO



CÓDIGO	MEDIDA	€/KIT	KITS x 
SAWH06070	M6 x 70	2,498	50

TN4S
Con taco de multimaterial de alta calidad

SA-WH

Fijación de WC horizontal. 2 PCS x KIT



SANEAMIENTO



CÓDIGO	MEDIDA	€/KIT	KITS x 
SAWHM06060	Ø6x60	5,402	50

TN4S
Con taco de multimaterial de alta calidad

SA-WHM

Fijación WC horizontal multiposición. 2 PCS x KIT



SANEAMIENTO



CÓDIGO	MEDIDA	€/100	KITS x 
SATEB0860	Ø8x60	129,406	50
SATEB1080	Ø10x80	218,246	50

TN4S
Con taco de multimaterial de alta calidad

SA-TE TB

Fijación de termos y calentadores. Tornillo. 2 PCS x KIT



SANEAMIENTO



CÓDIGO	MEDIDA	€/100	KITS x 
SATEA0865	Ø8x65	117,518	50
SATEA1075	Ø10x75	176,543	50

TN4S
Con taco de multimaterial de alta calidad

SA-TE AL

Fijación de termos y calentadores. Alcayata. 2 PCS x KIT



CO

Soporte para aire acondicionado

CO-SO

Juego soporte aire acondicionado. 2 PCS x KIT



SANEAMIENTO



CÓDIGO	MEDIDA	€/KIT	KITS x 
COSO15400	1,5 x 400	36,131	1
COSO15450	1,5 x 450	39,332	1
COSO15500	1,5 x 500	48,455	1
COSO20400	2 x 400	54,927	1
COSO20450	2 x 450	59,154	1
COSO20500	2 x 500	60,441	1

CO-KS

Kit silent block soporte AC. 4 PCS x KIT



SANEAMIENTO



CÓDIGO	MEDIDA	€/KIT	KITS x 
COKS08060	M8 x 60	8,151	1



EASYKITS

**easy
kits**

EKMULCAN

Canaletas - Rodapiés



MULTIMATERIAL



CÓDIGO	COMPONENTES	MEDIDA COMPONENTES	UDS X BOLSA	€/BOLSA	Nº MINIMO VENTA
EKMULCAN	TCCA05.050	5 x 50 Ø5	8	5,103	12
	BROCA GRATIS	5 x 85	1		

EKMULFAE

Fijacones accesorios exterior



MULTIMATERIAL



CÓDIGO	COMPONENTES	MEDIDA COMPONENTES	UDS X BOLSA	€/BOLSA	Nº MINIMO VENTA
EKMULFAE	TN4506	6 x 30 Ø6	4	5,103	12
	TPA240.050	4 x 50	4		
	BROCA GRATIS	6 x 100	1		

EKMULTEN

Tendederos - Antenas - AC



MULTIMATERIAL



CÓDIGO	COMPONENTES	MEDIDA COMPONENTES	UDS X BOLSA	€/BOLSA	Nº MINIMO VENTA
EKMULTEN	TN4508	8 x 40 Ø8	4	8,318	12
	TBA206.050	6 x 50	4		
	125IM06	M6	4		
	BROCA GRATIS	8 x 120	1		

EKMULAC

Aparatos de aire acondicionado



MULTIMATERIAL



CÓDIGO	COMPONENTES	MEDIDA COMPONENTES	UDS X BOLSA	€/BOLSA	Nº MINIMO VENTA
EKMULAC	TNUXE10.080	10 x 80 Ø10	4	5,226	12
	TN4506	6 x 30 Ø6	4		
	D12.505	M5	4		
	T8142.038	4,2 x 38	4		

EKMULTOL

Toldos



MULTIMATERIAL



CÓDIGO	COMPONENTES	MEDIDA COMPONENTES	UDS X BOLSA	€/BOLSA	Nº MINIMO VENTA
EKMULTOL	TNUXE08.080	8 x 80 Ø8	4	8,318	12
	BROCA GRATIS	8 x 120	1		

MULTIMATERIAL



CÓDIGO	COMPONENTES	MEDIDA COMPONENTES	UDS X BOLSA	€/BOLSA	Nº MINIMO VENTA
EKMULCAL	TN4S10	10 x 50 Ø10	2	8,318	12
	TB06.060	4 x 50	2		
	ALRO22.100	22x100 (6 x 79 x 23)	2		
	BROCA GRATIS	10 x 120	1		

EKMULCAL

Calderas - Calentadores



MULTIMATERIAL



CÓDIGO	COMPONENTES	MEDIDA COMPONENTES	UDS X BOLSA	€/BOLSA	Nº MINIMO VENTA
EKMULAV08	SALH08.100	M8 x 100	2	8,318	12
	BROCA GRATIS	8 x 120	11		
EKMULAV10	SALH10.120	M10 x 120	2	10,848	12
	BROCA GRATIS	10 x 120	1		

EKMULAV

Lavabos



MULTIMATERIAL



CÓDIGO	COMPONENTES	MEDIDA COMPONENTES	UDS X BOLSA	€/BOLSA	Nº MINIMO VENTA
EKMULCIS	SACIO6.080	M6 x 80	2	10,848	12

EKMULCIS

Cisternas WC



MULTIMATERIAL



CÓDIGO	COMPONENTES	MEDIDA COMPONENTES	UDS X BOLSA	€/BOLSA	Nº MINIMO VENTA
EKMULWCB	SAWZ05.080	M5 x 80	2	7,233	12
	BROCA GRATIS	8 x 120	1		

EKMULWCB

WC - Bidés



MULTIMATERIAL



CÓDIGO	COMPONENTES	MEDIDA COMPONENTES	UDS X BOLSA	€/BOLSA	Nº MINIMO VENTA
EKMULRAD	RATRG095	95	2	15,594	12
	BROCA GRATIS	8 x 120	1		

EKMULRAD

Radiadores



EKMULROB

Antirrobo



MULTIMATERIAL



CÓDIGO	COMPONENTES	MEDIDA COMPONENTES	UDS X BOLSA	€/BOLSA	Nº MINIMO VENTA
EKMULROB	TN4S10	10 x 50 Ø10	4	8,901	12
	INVN7.070	7 x 70	4		
	BROCA GRATIS	10 x 120	1		

EKMACILU

Iluminación - Cuadros



MACIZOS



CÓDIGO	COMPONENTES	MEDIDA COMPONENTES	UDS X BOLSA	€/BOLSA	Nº MINIMO VENTA
EKMACILU	TN4S06	6 x 30 Ø6	4	5,103	12
	TPPOZ40.045	4 x 45	4		
	ALRO18.050	18x50 (3,7 x 37 x 15)	4		
	BROCA GRATIS	6 x 100	1		

EKHUEILU

Iluminación - Cuadros



HUECOS



CÓDIGO	COMPONENTES	MEDIDA COMPONENTES	UDS X BOLSA	€/BOLSA	Nº MINIMO VENTA
EKHUEILU	TAPLANY	15 x 33	4	5,103	12
	TPPOZ45.045	4,5 x 45	4		
	ALRO19.050	19x50 (4,4 x 37 x 15)	4		

EKMACFTP

Fijaciones techo pesadas



MACIZOS



CÓDIGO	COMPONENTES	MEDIDA COMPONENTES	UDS X BOLSA	€/BOLSA	Nº MINIMO VENTA
EKMACFTP	TN4S10	10 x 50 Ø10	4	8,133	12
	TB06.060	6 x 60	4		
	D12.506	M6	4		
	BROCA GRATIS	10 x 120	1		

EKHUEFTP

Cisternas WC



HUECOS



CÓDIGO	COMPONENTES	MEDIDA COMPONENTES	UDS X BOLSA	€/BOLSA	Nº MINIMO VENTA
EKHUEFTP	BAESM06	M6 Ø16	4	7,233	12

EKMACFTL

Fijaciones techo ligeras



MACIZOS



CÓDIGO	COMPONENTES	MEDIDA COMPONENTES	UDS X BOLSA	€/BOLSA	Nº MINIMO VENTA
EKMACFTL	TN4S06	6 x 30 Ø6	4	5,103	12
	TPPOZ40.040	4 x 40	4		
	BROCA GRATIS	6 x 100	1		

HUECOS



CÓDIGO	COMPONENTES	MEDIDA COMPONENTES	UDS X BOLSA	€/BOLSA	N° MINIMO VENTA
EKHUEFTL	BAESM04	M4 Ø14	2	5,103	12

EKHUEFTL

Fijaciones techo ligeras



MACIZOS



CÓDIGO	COMPONENTES	MEDIDA COMPONENTES	UDS X BOLSA	€/BOLSA	N° MINIMO VENTA
EKMACFTG	TN4S06	6 x 30 Ø6	4	5,103	12
	ALHA19.070	19x70 (4,4 x 41 x 15)	4		
	BROCA GRATIS	6 x 100	1		

EKMACFTG

Fijaciones techo pesadas



HUECOS



CÓDIGO	COMPONENTES	MEDIDA COMPONENTES	UDS X BOLSA	€/BOLSA	N° MINIMO VENTA
EKHUEFTG	BAGAM06	10 x 80 Ø10	2	5,103	12

EKHUEFTG

Fijaciones techo gancho



MULTIMATERIAL



CÓDIGO	COMPONENTES	MEDIDA COMPONENTES	UDS X BOLSA	€/BOLSA	N° MINIMO VENTA
EKMULFAP	TN4S08	8 x 40 Ø8	4	7,233	12
	TPPOZ05.050	5 x 50	4		
	ALRO19.050	19x50 (4,4 x 37 x 15)	4		
	BROCA GRATIS	8 x 120	1		

EKMULFAP

Fijaciones accesorios pesados



MULTIMATERIAL



CÓDIGO	COMPONENTES	MEDIDA COMPONENTES	UDS X BOLSA	€/BOLSA	N° MINIMO VENTA
EKMULFAL	TN4S05	5 x 25 Ø5	4	5,103	12
	TPPOZ35.030	3,5 x 30	4		
	ALRO17.040	17x40 (3,5 x 29 x 13)	4		
	BROCA GRATIS	5 x 85	1		

EKMULFAL

Pequeñas fijaciones





**GAMA
INOX**



MTP

Anclaje macho para cargas altas en hormigón fisurado y no fisurado

MTP-A4

Homologado ETE Opt.1. Eje Inoxidable A4. Clip inoxidable A4



Útil de colocación

02 Info. Técnica
P. 377

INOXIDABLE



CÓDIGO	HOMOLOGACIÓN SÍSMICA	MEDIDA	€/100	ESPESOR MÁX. A FIJAR (MM)	LETRA EJE (LONGITUD)		
APA408075	-	M8 x 75 Ø8	317,357	9	C	100	600
APA408095	-	M8 x 95 Ø8	393,693	29	E	100	600
APA408115	-	M8 x 115 Ø8	445,823	49	G	100	400
APA408135	-	M8 x 135 Ø8	515,787	69	H	50	300
APA410090	C1 & C2	M10 x 90 Ø10	529,970	10	E	100	400
APA410105	C1 & C2	M10 x 105 Ø10	566,727	25	F	50	300
APA410115	C1 & C2	M10 x 115 Ø10	624,313	35	G	50	300
APA410135	C1 & C2	M10 x 135 Ø10	748,930	55	H	50	300
APA410165	C1 & C2	M10 x 165 Ø10	893,657	85	K	50	100
APA410185	C1 & C2	M10 x 185 Ø10	956,417	105	L	50	100
APA412110	C1 & C2	M12 x 110 Ø12	769,477	14	F	50	200
APA412120	C1 & C2	M12 x 120 Ø12	825,520	24	G	50	200
APA412130	C1 & C2	M12 x 130 Ø12	896,413	34	H	50	200
APA412150	C1 & C2	M12 x 150 Ø12	1.047,557	54	I	50	100
APA412180	C1 & C2	M12 x 180 Ø12	1.221,933	84	L	50	150
APA412200	C1 & C2	M12 x 200 Ø12	1.247,603	104	M	50	100
APA416125	C1 & C2	M16 x 125 Ø16	1.704,563	8	G	50	100
APA416145	C1 & C2	M16 x 145 Ø16	1.967,780	28	I	25	100
APA416175	C1 & C2	M16 x 175 Ø16	2.577,187	58	K	25	50
APA416190	C1 & C2	M16 x 190 Ø16	2.668,900	73	L	25	50
APA416220	C1 & C2	M16 x 220 Ø16	2.842,630	103	O	20	40
APA420200	C1 & C2	M20 x 200 Ø20	4.386,093	62	M	20	40
APA420240	C1 & C2	M20 x 240 Ø20	5.034,167	102	P	15	30
APA420285	C1 & C2	M20 x 285 Ø20	5.922,157	147	S	10	20

MTH

Anclaje macho para cargas altas en hormigón no fisurado

MTH-A2

Homologado ETE Opt.7. Eje inoxidable A2. Clip inoxidable A2



Útil de colocación

02 Info. Técnica
P. 391

INOXIDABLE



CÓDIGO	MEDIDA	€/100	ESPESOR MÁX. A FIJAR (MM)	LETRA EJE (LONGITUD)		
• MI06045	M6 x 45 Ø6	118,327	1	A	200	1.200
• MI06060	M6 x 60 Ø6	132,697	2	B	200	1.200
• MI06080	M6 x 80 Ø6	138,793	22	D	200	1.200
• MI06120	M6 x 120 Ø6	175,317	62	G	100	600
• MI06140	M6 x 140 Ø6	216,960	82	I	100	600
• MI06160	M6 x 160 Ø6	235,343	102	J	100	400
• MI06170	M6 x 170 Ø6	253,434	112	K	100	400
• MI06180	M6 x 180 Ø6	293,136	122	L	100	300
• MI08050	M8 x 50 Ø8	140,943	4	A	100	800
MI08075	M8 x 75 Ø8	154,380	5	C	100	600
MI08090	M8 x 90 Ø8	175,687	20	E	100	600
MI08115	M8 x 115 Ø8	227,260	45	G	100	400
MI10070	M10 x 70 Ø10	238,873	3	C	100	400
MI10090	M10 x 90 Ø10	267,387	10	E	100	400
MI10120	M10 x 120 Ø10	320,529	40	G	50	300
MI10150	M10 x 150 Ø10	446,763	70	I	50	200
• MI12075	M12 x 75 Ø12	362,203	5	C	50	300
MI12090	M12 x 90 Ø12	384,384	13	D	50	200
MI12110	M12 x 110 Ø12	423,588	18	F	50	200
MI12140	M12 x 140 Ø12	530,916	48	I	50	200
• MI16090	M16 x 90 Ø16	1.000,270	4	D	25	150
MI16145	M16 x 145 Ø16	1.392,707	23	I	25	100
MI16170	M16 x 170 Ø16	1.576,917	48	K	25	75
• MI20120	M20 x 120 Ø20	1.807,833	5	G	25	40
MI20170	M20 x 170 Ø20	2.444,500	23	K	20	40
MI20220	M20 x 220 Ø20	3.062,987	73	O	20	40

• Medidas sin homologar
• Medida sin homologar para fuego

Caja ventana

CÓDIGO	MEDIDA	€/CAJA	PCS	CAJAS
VMI08075	M8 x 75 Ø8	22,100	10	8
VMI08090	M8 x 90 Ø8	23,629	10	8
VMI10070	M10 x 70 Ø10	24,417	8	8
VMI10090	M10 x 90 Ø10	27,331	8	8
VMI10120	M10 x 120 Ø10	24,026	6	8
VMI12110	M12 x 110 Ø12	29,808	6	8



Anclaje macho para cargas altas en hormigón no fisurado

MTH

02 Info
P. 350 Técnica

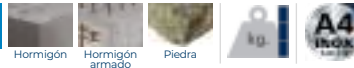
INOXIDABLE



CÓDIGO	MEDIDA	€/100	ESPESOR MÁX. A FIJAR (MM)	LETRA EJE (LONGITUD)		
• MIA406045	M6 x 45 Ø6	146,353	1	A	200	1.200
• MIA406060	M6 x 60 Ø6	159,443	2	B	200	1.200
• MIA406080	M6 x 80 Ø6	178,310	22	D	200	1.200
• MIA408050	M8 x 50 Ø8	187,323	4	A	100	800
MIA408075	M8 x 75 Ø8	207,767	5	C	100	600
MIA408090	M8 x 90 Ø8	226,910	20	E	100	600
MIA408115	M8 x 115 Ø8	285,133	45	G	100	400
MIA410070	M10 x 70 Ø10	325,793	3	C	100	400
MIA410090	M10 x 90 Ø10	369,267	10	E	100	400
MIA410120	M10 x 120 Ø10	448,880	40	G	50	300
MIA410150	M10 x 150 Ø10	657,360	70	I	50	200
• MIA412075	M12 x 75 Ø12	498,023	5	C	50	300
MIA412090	M12 x 90 Ø12	529,160	13	D	50	200
MIA412110	M12 x 110 Ø12	596,347	18	F	50	200
MIA412140	M12 x 140 Ø12	715,110	48	I	50	200
• MIA416090	M16 x 90 Ø16	1.321,547	4	D	25	150
MIA416145	M16 x 145 Ø16	1.736,247	23	I	25	100
MIA416170	M16 x 170 Ø16	2.004,967	48	K	25	75
• MIA420120	M20 x 120 Ø20	2.330,647	5	G	20	40
MIA420170	M20 x 170 Ø20	3.185,910	23	K	20	40
MIA420220	M20 x 220 Ø20	3.966,147	73	O	20	40

• Medidas sin homologar
• Medida sin homologar para fuego

MTH-A4

Homologado ETE Opt.7. Eje inoxidable A4. Clip inoxidable A4



Disponibles con arandela DIN 9021.
Consultar precio y plazo

Útil de colocación

 Caja ventana

CÓDIGO	MEDIDA	€/CAJA	PCS	CAJAS
VMIA408075	M8 x 75 Ø8	28,783	10	8
VMIA410090	M10 x 90 Ø10	39,392	8	8
VMIA412110	M12 x 110 Ø12	45,068	6	8



Anclaje de fijación directa en hormigón Bimetal (cuerpo inoxidable A4 y punta de acero al carbono). Homologado ETE Opt.1

TX

02 Info
P. 355 Técnica

MACIZOS



CÓDIGO	MEDIDA	€/100		ESPESOR MÁX. A FIJAR (MM)	
TXE06040	Ø6 x 40	224,863	10	5	100
TXE06060	Ø6 x 60	251,333	10	5	100
TXE08070	Ø8 x 70	362,343	13	5	50
TXE08080	Ø8 x 80	400,000	13	15	25
TXE08090	Ø8 x 90	450,000	13	25	25
TXE08105	Ø8 x 105	525,027	13	40	25
TXE10070	Ø10 x 70	441,697	15	15	50
TXE10090	Ø10 x 90	567,897	15	5	25
TXE10100	Ø10 x 100	609,187	15	15	25
TXE10120	Ø10 x 120	693,627	15	35	25
TXE12080	Ø12 x 80	659,273	18	5	25
TXE12110	Ø12 x 110	906,500	18	5	25



Homologado ETE Opt.1. Cabeza hexagonal



02 Info
P. 355 Técnica

MACIZOS



CÓDIGO	MEDIDA	€/100		ESPESOR MÁX. A FIJAR (MM)	
TXA08060	Ø8 x 60	372,600	TX45	10	50
TXA08080	Ø8 x 80	445,003	TX45	15	25
TXA08120	Ø8 x 120	588,647	TX45	55	25
TXA10070	Ø10 x 70	535,117	TX50	15	50
TXA10090	Ø10 x 90	661,480	TX50	5	25
TXA10120	Ø10 x 120	829,027	TX50	35	25

Homologado ETE Opt.1. Cabeza avellanada



TX

Anclaje de fijación directa en hormigón Bimetal (cuerpo inoxidable A4 y punta de acero al carbono). Homologado ETE Opt.1

NEW TXP

Homologado ETE Opt.1. Cabeza alomada

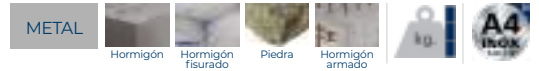

CÓDIGO	MEDIDA	€/100		
TXP06050	Ø6 x 50	294,162	50	800
TXP06060	Ø6 x 60	311,603	50	600
TXP06080	Ø6 x 80	347,320	50	400
TXP06100	Ø6 x 100	382,173	50	400
TXP08060	Ø8 x 60	358,864	25	400
TXP08080	Ø8 x 80	414,539	25	400

NEW TXT

Homologado ETE Opt.1. Cabeza Truss

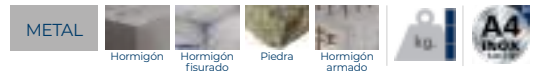

CÓDIGO	MEDIDA	€/100		
TXT06040	Ø6 x 40	270,765	50	1.200
TXT06050	Ø6 x 50	287,504	50	1.200
TXT06060	Ø6 x 60	303,541	50	800

CH

Anclaje camisa antigiro para cargas medias

CH-A2

Inoxidable A2. Homologado ETE Opt.7

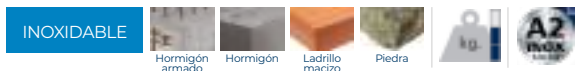

CÓDIGO	MEDIDA	€/100		
ACHTA208C	M6 x 45 Ø8	109,583	100	1.200
• ACHTA209C	M6 x 45 Ø9	124,010	100	1.200
ACHTA208L	M6 x 60 Ø8	123,800	100	600
• ACHTA209L	M6 x 60 Ø9	143,233	100	600
ACHTA210C	M8 x 60 Ø10	177,550	100	600
• ACHTA211C	M8 x 60 Ø11	213,603	100	400
ACHTA210L	M8 x 80 Ø10	204,243	100	400
• ACHTA211L	M8 x 80 Ø11	251,620	100	400
ACHTA212C	M10 x 70 Ø12	299,513	100	200
• ACHTA214C	M10 x 70 Ø14	398,427	100	300
ACHTA212L	M10 x 100 Ø12	366,293	50	200
• ACHTA214L	M10 x 100 Ø14	444,400	50	200
ACHTA216C	M12 x 80 Ø16	590,597	50	100
ACHTA216L	M12 x 110 Ø16	747,340	50	100
ACHTA220C	M16 x 110 Ø20	1.534,333	25	75

• Medidas sin homologar

Caja ventana

CÓDIGO	MEDIDA	€/CAJA	PCS	CAJAS
VACHTA208C	M6 x 45 Ø8	12,948	10	8
VACHTA208L	M6 x 60 Ø8	15,055	10	8
VACHTA210C	M8 x 60 Ø10	13,481	6	8
VACHTA210L	M8 x 80 Ø10	16,052	6	8
VACHTA212C	M10 x 70 Ø12	15,128	4	8
VACHTA212L	M10 x 100 Ø12	18,672	4	8



Anclaje camisa antigiro para cargas medias

CH

02 Info
Técnica
p. 389

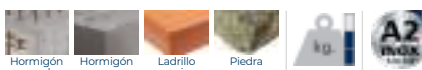
INOXIDABLE



CÓDIGO	MEDIDA	€/100			
ACHTP108C	M6 x 45 Ø8	113,997	4	100	1.200
ACHTP108L	M6 x 60 Ø8	138,665	4	100	1.200
ACHTP110C	M8 x 60 Ø10	204,304	5	100	600
ACHTP110L	M8 x 80 Ø10	241,854	5	100	400
ACHTP12C	M10 x 70 Ø12	323,051	6	50	300
ACHTP12L	M10 x 100 Ø12	401,477	6	50	300

CH-PI

Cabeza plana inoxidable A2.
Homologado ETE Opt.7



02 Info
Técnica
p. 390

INOXIDABLE

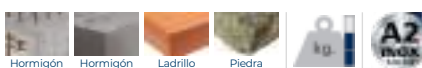

CÓDIGO	MEDIDA	€/100	APERTURA GANCHO		
ACHGA208C	M6 x 45 Ø8	447,373	10	100	600
ACHGA210C	M8 x 60 Ø10	664,537	11	100	400
ACHGA212C	M10 x 70 Ø12	881,317	14	50	200

CH-GF A2



Gancho forjado. Inoxidable A2

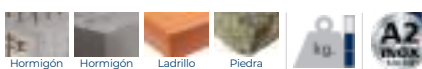

02 Info
Técnica
p. 390

INOXIDABLE



CÓDIGO	MEDIDA	€/100	Ø OJO		
ACHAA208C	M6 x 45 Ø8	491,243	10	100	600
ACHAA210C	M8 x 60 Ø10	783,613	11	100	400
ACHAA212C	M10 x 70 Ø12	1.045,200	14	50	200

CH-AF A2

Argolla forjada. Inoxidable A2





Anclaje hembra con cono interior para grandes cargas

HE

02 Info
Técnica
p. 391

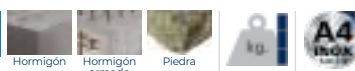
INOXIDABLE



CÓDIGO	MEDIDA	€/100		
HEA4M06	M6 x 25 Ø8	102,750	100	4.000
HEA4M08	M8 x 30 Ø10	146,510	100	1.600
HEA4M10	M10 x 40 Ø12	231,770	50	800
HEA4M12	M12 x 50 Ø15	438,380	50	600
HEA4M16	M16 x 65 Ø20	930,627	25	250
HEA4M20	M20 x 80 Ø25	1.784,273	25	100

HE-A4



Inoxidable A4. Homologado ETE
Aplicaciones no estructurales



02 Info
Técnica
p. 391

INOXIDABLE



CÓDIGO	MEDIDA	€/100		
HEC4M06	M6 x 25 Ø8	141,623	100	3.200
HEC4M08	M8 x 30 Ø10	192,640	100	1.600
HEC4M10	M10 x 40 Ø12	297,627	50	800
HEC4M12	M12 x 50 Ø15	563,283	50	400

HE-C4

Con collarín. Inoxidable A4.
Homologado ETE Aplicaciones no
estructurales



AC

Anclaje de acero con aletas para cargas altas

AC-CI

Cápsula. Inoxidable A4



02 Info. Técnica
P. 395

INOXIDABLE

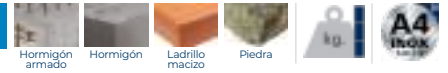

CÓDIGO	MEDIDA	€/100		
AACCI06	M6 x 40 Ø10	406,123	50	1.200
AACCI08	M8 x 50 Ø14	736,383	50	600
AACCI10	M10 x 60 Ø16	850,880	25	300
AACCI12	M12 x 80 Ø20	1.524,433	10	120

HI

Anclaje antigiro para cargas altas

HI-CI

Cápsula. Inoxidable A2



02 Info. Técnica
P. 395

INOXIDABLE

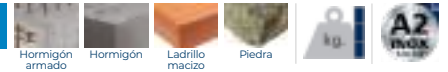

CÓDIGO	MEDIDA	€/100		
AHIC10645	M6 x 45 Ø12	642,275	100	600
AHIC10855	M8 x 55 Ø14	800,887	50	600
AHIC11065	M10 x 65 Ø16	1.069,243	50	300

AV

Anclaje para fachadas ventiladas

AVR

Roscado



INOXIDABLE



CÓDIGO	MEDIDA	€/100		
AVR08120	M8 x 120 Ø8	293,609	100	600
AVR08150	M8 x 150 Ø8	318,543	100	600
AVR10120	M10 x 120 Ø10	359,184	100	400
AVR10150	M10 x 150 Ø10	411,042	100	200
AVR10180	M10 x 180 Ø10	457,326	100	200

AVC

Corrugado



INOXIDABLE







CÓDIGO	MEDIDA	€/100		
AVC08120	8 x 120 Ø8	403,750	100	400
AVC08150	8 x 150 Ø8	460,750	100	-
AVC10120	10 x 120 Ø10	566,103	100	400
AVC10150	10 x 150 Ø10	648,407	100	200
AVC10180	10 x 180 Ø10	732,023	100	200

Tige fileada para sellamiento químico con rondella y écrou

EQ

QUÍMICOS



CÓDIGO	MEDIDA	€/100			CÓDIGO	MEDIDA	€/100		
EQA208110	M8 x 110	252,930	10	240	EQA220260	M20 x 260	2.887,737	6	12
EQA210130	M10 x 130	439,997	10	120	EQA224300	M24 x 300	4.614,763	6	12
EQA212160	M12 x 160	729,210	10	120	EQA230330	M30 x 330	7.745,917	6	12
EQA216190	M16 x 190	1.510,907	10	40					





EQ-A2

Inoxidable A2



QUÍMICOS



CÓDIGO	MEDIDA	€/100			CÓDIGO	MEDIDA	€/100		
EQA408110	M8 x 110	338,743	10	240	EQA420260	M20 x 260	5.048,270	6	12
EQA410130	M10 x 130	615,293	10	120	EQA424300	M24 x 300	8.320,540	6	12
EQA412160	M12 x 160	1.058,413	10	120	EQA430330	M30 x 330	15.411,365	6	12
EQA416190	M16 x 190	2.073,420	10	40					

EQ-A4

Inoxidable A4





Taco de nylon universal de alto rendimiento

T-NUX

02 Info Técnica
p. 401

INOXIDABLE



CÓDIGO	MEDIDA	€/100		ESPESOR MÁX. A FIJAR (MM)		
• TNXA408080	8 x 80 Ø8	255,723	TX30	10	50	600
• TNXA408100	8 x 100 Ø8	308,360	TX30	30	50	600
• TNXA408120	8 x 120 Ø8	364,898	TX30	50	50	300
TNXA410080	10 x 80 Ø10	342,620	TX40	10	50	300
TNXA410100	10 x 100 Ø10	409,077	TX40	30	50	300
TNXA410120	10 x 120 Ø10	476,397	TX40	50	50	300
TNXA410140	10 x 140 Ø10	564,920	TX40	70	50	300

• Medida sin homologar para fuego



T-NUX A A4

Inoxidable A4. Cabeza avellanada. Huella TX. Homologado ETE



02 Info Técnica
p. 401

INOXIDABLE

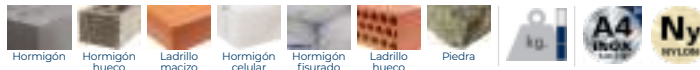

CÓDIGO	MEDIDA	€/100	Nº HUELLA	ESPESOR MÁX. A FIJAR (MM)		
• TNXE408080	8 x 80 Ø8	340,083	SW10/TX30	10	50	600
• TNXE408100	8 x 100 Ø8	403,086	SW10/TX30	30	50	300
TNXE410080	10 x 80 Ø10	451,086	SW13/TX40	10	50	300
TNXE410100	10 x 100 Ø10	471,096	SW13/TX40	30	50	300
TNXE410120	10 x 120 Ø10	597,720	SW13/TX40	50	50	300
TNXE410140	10 x 140 Ø10	733,937	SW13/TX40	70	50	200

• Medida sin homologar para fuego



T-NUX E A4

Inoxidable A4. Cabeza hexagonal. Huella TX. Homologado ETE







Taco clavable de poliamida 6.6, premontado con tornillo rosca-arpón

TC

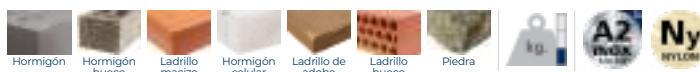
02 Info Técnica
p. 403

INOXIDABLE



CÓDIGO	MEDIDA	€/100		ESPESOR MÁX. A FIJAR (MM)		
TCA205030	5 x 30 Ø5	46,088	PZ2	5	100	2.400
TCA206040	6 x 40 Ø6	59,964	PZ2	10	100	1.200
TCA206060	6 x 60 Ø6	85,789	PZ2	30	100	1.200
TCA208060	8 x 60 Ø8	135,022	PZ3	20	100	600
TCA208080	8 x 80 Ø8	158,402	PZ3	40	100	600
TCA208100	8 x 100 Ø8	208,343	PZ3	60	100	600

Taco con cabeza avellanada y tornillo inoxidable A2



RE

Remaches

RE-IN

Cabeza alomada. Acero inoxidable A2



METAL



CÓDIGO	MEDIDA	€/100	Ø BROCA	ESPOSOR MÁX. A FIJAR (MM)		
REIN3206	3,2 x 6,4	15,697	3,3	0,5 - 3	500	6.000
REIN3208	3,2 x 8	16,793	3,3	3 - 5	500	6.000
REIN3212	3,2 x 12,7	24,747	3,3	6,5 - 8,5	500	6.000
REIN3215	3,2 x 15,9	29,900	3,3	10,5 - 12,5	500	6.000
REIN4008	4 x 8,5	28,190	4,1	2,5 - 4,5	500	6.000
REIN4010	4 x 10,2	29,997	4,1	4,5 - 6,5	500	6.000
REIN4012	4 x 12	33,997	4,1	6,5 - 8,5	500	6.000
REIN4016	4 x 16	41,163	4,1	10 - 12	500	3.000
REIN4810	4,8 x 10,8	41,473	5	4 - 6	500	3.000
REIN4812	4,8 x 12	45,333	5	6 - 8	500	3.000
REIN4816	4,8 x 16	55,733	5	8 - 11	250	3.000
REIN4818	4,8 x 18	59,590	5	13 - 15	250	3.000
REIN4820	4,8 x 20,3	78,197	5	11 - 13	250	3.000

SJ

Sujetacable DIN 741

SJ-A4

Inoxidable A4



METAL



CÓDIGO	MEDIDA	€/100		
SJA42103	M4(Ø3)	175,590	50	1.200
SJA42305	M5(Ø5)	231,300	40	960
SJA42606	M5(Ø6)	252,720	20	900
SJA43008	M6(Ø8)	265,590	20	480
SJA43410	M8(Ø10)	471,150	10	240
SJA43611	M8(Ø11)	685,350	10	240
SJA44414	M10(Ø14)	805,320	5	225
SJA45016	M12(Ø16)	1.280,700	5	120
SJA45418	M12(Ø18)	1.927,530	5	80
SJA46122	M14(Ø22)	2.732,850	1	45
SJA46525	M14(Ø25)	3.062,610	1	24

SJ-P

Sujetacable plano

SJ-PS A4

Simple. Inoxidable A4



METAL



CÓDIGO	MEDIDA	€/100		
SJPSA40403	M4(Ø3)	89,953	30	1.350
SJPSA40504	M5(Ø4)	132,787	30	1.350
SJPSA40605	M6(Ø5)	184,187	20	900
SJPSA40606	M6(Ø6)	312,687	10	450

SJ-PD A4

Doble. Inoxidable A4



METAL



CÓDIGO	MEDIDA	€/100		
SJPDA40403	M4(Ø3)	149,920	30	720
SJPDA40504	M5(Ø4)	244,157	30	720
SJPDA40605	M5(Ø5)	304,123	20	480
SJPDA40606	M6(Ø6)	526,857	10	240

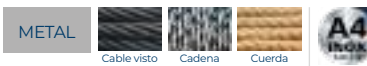

Tensor gancho/anilla DIN-1480

TS-GA



TS-GA A4

Inoxidable A4

CÓDIGO	MEDIDA	€/100		
TSGAA405	M5	444,531	10	240
TSGAA406	M6	623,235	10	120
TSGAA410	M10	1.620,375	5	30
TSGAA412	M12	3.053,841	5	30



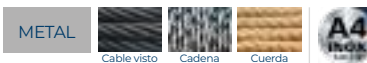

Tensor anilla/anilla DIN-1480

TS-AA



TS-AA A4

Inoxidable A4

CÓDIGO	MEDIDA	€/100		
TSAAA405	M5	444,531	10	240
TSAAA406	M6	623,235	10	120
TSAAA408	M8	1.126,530	10	60
TSAAA410	M10	1.620,375	5	20
TSAAA412	M12	3.053,841	5	20



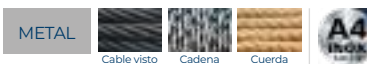

Tensor gancho/gancho DIN-1480

TS-GG



TS-GG A4

Inoxidable A4

CÓDIGO	MEDIDA	€/100		
TSGGA405	M5	444,531	10	240
TSGGA406	M6	623,235	10	120
TSGGA408	M8	1.126,530	10	-
TSGGA410	M10	1.620,375	5	20
TSGGA412	M12	3.053,841	5	15



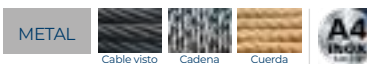

Cáncamo hembra D-582

EV-H



EV-H A4

Inoxidable A4

CÓDIGO	MEDIDA	€/100		
EVHA406	M6(Ø15)	188,470	10	450
EVHA408	M8(Ø20)	304,123	10	450
EVHA410	M10(Ø25)	578,260	10	240
EVHA412	M12(Ø30)	856,680	5	120
EVHA414	M14(Ø30)	1.285,020	5	120
EVHA416	M16(Ø35)	1.499,190	1	-
EVHA420	M20(Ø38)	1.970,363	1	-
EVHA424	M24(Ø50)	4.283,400	1	24



EV-M

Cáncamo macho D-580

EV-M A4

Inoxidable A4

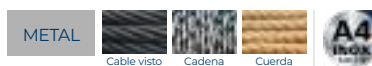

CÓDIGO	MEDIDA	€/100		
EVMA406	M6 (Ø20)	207,317	10	450
EVMA408	M8 (Ø20)	334,536	10	450
EVMA410	M10 (Ø25)	636,086	10	240
EVMA412	M12 (Ø30)	942,348	5	120
EVMA414	M14 (Ø35)	1.413,522	5	120
EVMA416	M16 (Ø35)	1.649,109	1	45
EVMA420	M20 (Ø40)	2.167,400	1	-
EVMA424	M24 (Ø50)	4.711,740	1	12

GR

Grillete recto

GR-A4

Inoxidable A4

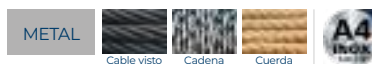

CÓDIGO	MEDIDA	€/100		
GRA404	M4 (Ø8)	188,470	25	1.125
GRA405	M5 (Ø10)	205,603	25	1.125
GRA406	M6 (Ø12)	235,587	25	600
GRA408	M8 (Ø16)	351,240	10	240
GRA410	M10 (Ø19)	565,410	10	120
GRA412	M12 (Ø25)	890,947	5	60
GRA414	M14 (Ø28)	1.434,940	5	60
GRA416	M16 (Ø32)	2.056,033	5	40
GRA419	M20 (Ø38)	4.026,397	1	-
GRA425	M25 (Ø50)	8.652,467	1	-

GD

Guardacabo DIN-6899/A

GD-A4

Inoxidable A4

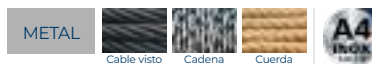

CÓDIGO	MEDIDA	€/100		
GDA402	M2 (Ø10)	35,553	100	4.500
GDA403	M3 (Ø12)	51,403	100	4.500
GDA404	M4 (Ø13)	59,967	50	2.250
GDA405	M5 (Ø14)	81,383	50	1.200
GDA406	M6 (Ø15)	94,237	50	1.200
GDA408	M8 (Ø18)	179,903	50	600
GDA410	M10 (Ø22)	295,553	25	300
GDA412	M12 (Ø26)	346,957	10	120
GDA415	M15 (Ø32)	599,677	5	60

GI

Grillete lira

GI-A4

Inoxidable A4

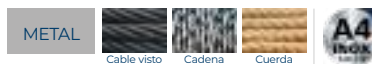

CÓDIGO	MEDIDA	€/100		
GIA404	M4 (Ø6)	239,870	25	1.125
GIA405	M5 (Ø8)	261,287	25	1.125
GIA406	M6 (Ø10)	286,990	10	450
GIA408	M8 (Ø12)	428,340	10	240
GIA410	M10 (Ø16)	706,760	10	120
GIA412	M12 (Ø28)	1.113,683	5	60
GIA414	M14 (Ø33)	1.927,530	5	60
GIA416	M16 (Ø37)	2.634,290	5	30

Tornillo autotaladrante de cabeza hexagonal

DIN-7504-K

INOXIDABLE



DIN-7504-K A2

Tornillo. Inoxidable A2

CÓDIGO	MEDIDA	€/100			
ABEI4213	4,2 x 13	16,077	7	1.000	12.000
ABEI4216	4,2 x 16	18,037	7	1.000	8.000
ABEI4219	4,2 x 19	18,697	7	1.000	8.000
ABEI4813	4,8 x 13	22,743	8	1.000	8.000
ABEI4816	4,8 x 16	22,223	8	500	6.000
ABEI4819	4,8 x 19	24,047	8	500	6.000
ABEI4825	4,8 x 25	26,930	8	500	6.000
ABEI4832	4,8 x 32	32,017	8	500	3.000
ABEI5519	5,5 x 19	33,200	8	500	6.000
ABEI5522	5,5 x 22	35,420	8	500	4.000
ABEI5525	5,5 x 25	37,643	8	500	6.000
ABEI6319	6,3 x 19	50,320	10	500	3.000
ABEI6325	6,3 x 25	57,247	10	500	3.000



Tornillo autotaladrante inoxidable bimetálico con cabeza hexagonal

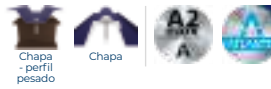

ABE BIMETAL

METAL



ABE BIMETAL

Tornillo

CÓDIGO	MEDIDA	€/100		ESPESOR MÁX. A FIJAR (MM)	CAPACIDAD DE TALADRO		
BIE4825	4,8 x 25	69,317	8	9	1,75-4,40	500	6.000
BIE5525	5,5 x 25	81,253	8	5	1,75-5,25	500	6.000
BIE5532	5,5 x 32	93,313	8	12	1,75-5,25	500	3.000
BIE5538	5,5 x 38	99,213	8	18	1,75-5,25	500	3.000
BIE5550	5,5 x 50	114,513	8	30	1,75-5,25	500	2.000
BIE5558	5,5 x 58	127,457	8	38	1,75-5,25	250	1.500
BIE5565	5,5 x 65	133,217	8	45	1,75-5,25	250	1.500
BIE5580	5,5 x 80	157,167	8	60	1,75-5,25	250	1.000
BIE6325	6,3 x 25	104,047	10	7	2,50-6,00	500	3.000



METAL

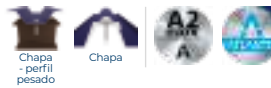

ABE BIMETAL + ARVUL

Tornillo con arandela vulcanizada de acero-EPDM

CÓDIGO	MEDIDA	€/100		ESPESOR MÁX. A FIJAR (MM)	CAPACIDAD DE TALADRO		
BIE164825	4,8 x 25 P16	83,140	8	7	1,75-4,40	500	2.000
BIE165525	5,5 x 25 P16	96,320	8	3	1,75-5,25	500	2.000
BIE165532	5,5 x 32 P16	109,580	8	10	1,75-5,25	500	2.000
BIE165538	5,5 x 38 P16	115,253	8	16	1,75-5,25	500	1.500
BIE165550	5,5 x 50 P16	134,430	8	28	1,75-5,25	500	1.500
BIE165558	5,5 x 58 P16	144,637	8	36	1,75-5,25	250	1.500
BIE165565	5,5 x 65 P16	150,527	8	43	1,75-5,25	250	1.500
BIE165580	5,5 x 80 P16	175,167	8	58	1,75-5,25	250	1.000
BIE166325	6,3 x 25 P16	120,333	10	5	2,50-6,00	500	2.000



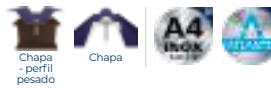

METAL



ABE A4 BIMETAL ^{NEW}

Tornillo inoxidable A4

CÓDIGO	MEDIDA	€/100	ESPESOR MÁX. A FIJAR (MM)	CAPACIDAD DE TALADRO		
BIE45525	5,5 x 25	106,444	3	1,75-5,25	500	4.000
BIE45532	5,5 x 32	115,344	10	1,75-5,25	500	3.000
BIE45550	5,5 x 50	147,644	28	1,75-5,25	500	2.000
BIE45565	5,5 x 65	177,822	43	1,75-5,25	250	1.500
BIE46325	6,3 x 25	137,133	5	2,50-6,00	500	3.000



AUTO BIMETAL Tornillo viga autotaladrante inoxidable bimetetal con cabeza hexagonal

AUTO BIMETAL

Tornillo



CÓDIGO	MEDIDA	€/100		ESPEJOR MÁX. A FIJAR (MM)	CAPACIDAD DE TALADRO		
BAUTO5540	5,5 x 40	118,609	8	10	4,00-12,00	500	3.000
BAUTO5550	5,5 x 50	159,790	8	20	4,00-12,00	500	3.000
BAUTO5565	5,5 x 65	166,927	8	35	4,00-12,00	250	1.500
BAUTO5580	5,5 x 80	214,237	8	50	4,00-12,00	250	1.000
BAUTO5510	5,5 x 100	216,643	8	70	4,00-12,00	100	600

AUTO BIMETAL + ARVUL

Tornillo con arandela vulcanizada de acero-EPDM



CÓDIGO	MEDIDA	€/100		ESPEJOR MÁX. A FIJAR (MM)	CAPACIDAD DE TALADRO		
BAUTO165540	5,5 x 40 P16	140,588	8	8	4,00-12,00	500	1.500
BAUTO165550	5,5 x 50 P16	184,233	8	18	4,00-12,00	500	1.500
BAUTO165565	5,5 x 65 P16	190,353	8	33	4,00-12,00	250	1.500
BAUTO165580	5,5 x 80 P16	223,733	8	48	4,00-12,00	250	1.000
BAUTO165510	5,5 x 100 P16	238,365	8	68	4,00-12,00	100	600

PS

Tornillo autotaladrante de cabeza hexagonal para panel sándwich

PS 3 + ARVUL A2

Punta broca estándar #3 con recubrimiento ATLANTIS C4-M y arandela inoxidable A2



CÓDIGO	MEDIDA	€/100		ESPEJOR MÁX. A FIJAR (MM)	CAPACIDAD DE TALADRO		
PS1955195	5,5 / 6,3 x 195 P19	303,319	8	130 - 185	1,50-6,00	200	400
PS1955230	5,5 / 6,3 x 230 P19	364,325	8	166 - 215	1,50-6,00	200	-

PS 5 + ARVUL A2

Punta broca extra larga #5 con recubrimiento ATLANTIS C4-M y arandela inoxidable A2



CÓDIGO	MEDIDA	€/100		ESPEJOR MÁX. A FIJAR (MM)	CAPACIDAD DE TALADRO		
PSL1955255	5,5 / 6,3 x 255 P19	514,352	8	170 - 210	6,00-12,00	200	
PSL1955285	5,5 / 6,3 x 285 P19	804,912	8	200 - 250	6,00-12,00	200	

NEW PST 3 + ARVUL A2

Tornillo con punta broca estándar #3 con recubrimiento ATLANTIS C4-M y arandela inoxidable A2



CÓDIGO	MEDIDA	€/100		ESPEJOR MÁX. A FIJAR (MM)	CAPACIDAD DE TALADRO		
PST1655060	5,5 / 6,3 x 60 P16	56,360	8	31 - 45	1,50-6,00	100	1.200
PST1655082	5,5 / 6,3 x 82 P16	66,557	8	43 - 67	1,50-6,00	100	600
PST1655098	5,5 / 6,3 x 98 P16	72,273	8	54 - 83	1,50-6,00	100	600
PST1655115	5,5 / 6,3 x 115 P16	86,140	8	56 - 100	1,50-6,00	100	600

NEW PST 5 + ARVUL A2

Tornillo con punta broca extra larga #5 con recubrimiento ATLANTIS C4-M y arandela inoxidable A2





CÓDIGO	MEDIDA	€/100		ESPEJOR MÁX. A FIJAR (MM)	CAPACIDAD DE TALADRO		
PSTL1655075	5,5 / 6,3 x 75 P16	63,827	8	33 - 60	6,00-12,00	100	1.200
PSTL1655085	5,5 / 6,3 x 85 P16	70,980	8	38 - 70	6,00-12,00	100	600
PSTL1655105	5,5 / 6,3 x 105 P16	87,957	8	48 - 90	6,00-12,00	100	600
PSTL1655130	5,5 / 6,3 x 130 P16	114,480	8	63 - 115	6,00-12,00	100	600

Arandela vulcanizada de acero-EPDM

ARVUL

INOXIDABLE



CÓDIGO	MEDIDA	€/100	Ø INTERIOR ARANDELA		
ARINO14	P14	11,587	2.5	1.000	12.000
ARINO16	P16	13,100	2.7	1.000	6.000
ARINO18	P18	16,487	3.2	1.000	6.000
ARINO25	P25	30,483	3.3	500	3.000
ARINOM30	P30	48,630	6.3	500	1.500

ARVUL A2

Inoxidable A2



Arandela paraguas

ARPAR

METAL



CÓDIGO	MEDIDA	€/100		
ARPARA225	P22	41,150	250	1.500

ARPAR A2

Inoxidable A2





Tornillo autotaladrante de cabeza alomada

DIN-7504-N

INOXIDABLE



CÓDIGO	MEDIDA	€/100		ESPESOR MÁX. A FIJAR (MM)	CAPACIDAD DE TALADRO		
ABRA23509	3,5 x 9,5	10,940	PH2	2,85	0,70-2,25	1.000	24.000
ABRA23513	3,5 x 13	12,960	PH2	6,2	0,70-2,25	500	12.000
ABRA23519	3,5 x 19	15,880	PH2	12,1	0,70-2,25	500	12.000
ABRA24213	4,2 x 13	15,180	PH2	4,3	1,75-3,00	500	12.000
ABRA24216	4,2 x 16	17,007	PH2	7,3	1,75-3,00	500	12.000
ABRA24219	4,2 x 19	18,097	PH2	10,3	1,75-3,00	500	12.000
ABRA24225	4,2 x 25	19,713	PH2	16,3	1,75-3,00	250	6.000
ABRA24816	4,8 x 16	23,813	PH2	5,5	1,75-4,40	250	6.000
ABRA24819	4,8 x 19	24,193	PH2	8,7	1,75-4,40	250	6.000
ABRA24825	4,8 x 25	26,880	PH2	14,7	1,75-4,40	250	6.000
ABRA24832	4,8 x 32	31,460	PH2	21,5	1,75-4,40	250	4.000
ABRA24838	4,8 x 38	34,443	PH2	27,5	1,75-4,40	250	3.000
ABRA24850	4,8 x 50	40,613	PH2	39,5	1,75-4,40	250	3.000

DIN-7504-N HP A2

Inoxidable A2. Huella PH





Tornillo punta broca, cabeza remache y huella PH

RS

INOXIDABLE



CÓDIGO	MEDIDA	€/100		ESPESOR MÁX. A FIJAR (MM)	CAPACIDAD DE TALADRO		
RSA23509	3,5 x 9,5	14,270	PH2	2,8	0,75 - 2,25	500	22.500
RSA24213	4,2 x 13	20,557	PH2	7,3	1,75 - 3	500	22.500
RSA24216	4,2 x 16	21,897	PH2	10,3	1,75 - 3	500	12.000
RSA24219	4,2 x 19	23,220	PH2	16,3	1,75 - 3	500	12.000
RSA24816	4,8 x 16	28,733	PH2	5,5	1,75 - 4,4	250	11.250
RSA24819	4,8 x 19	30,790	PH2	8,7	1,75 - 4,4	250	11.250
RSA24825	4,8 x 25	34,737	PH2	14,7	1,75 - 4,4	250	6.000

RS-A2

Inoxidable A2



BCP

Tornillo autotaladrante de cabeza extraplana y huella PH

BCP A2

Inoxidable A2. Huella PH

INOXIDABLE



CÓDIGO	MEDIDA	€/100		ESPESOR MÁX. A FIJAR (MM)	CAPACIDAD DE TALADRO		
BCPA24214	4,2 x 14	20,323	PH2	6	0,70-2,00	500	12.000
BCPA24223	4,2 x 23	28,050	PH2	6	-	500	12.000

CPC

Tornillo rosca chapa con cabeza extraplana

CP-A2

Inoxidable A2. Huella PH

INOXIDABLE



CÓDIGO	MEDIDA	€/100		ESPESOR MÁX. A FIJAR (MM)		
TCPA24213	4,2 x 13	9,134	PH2	6	500	12.000
TCPA24222	4,2 x 22	15,680	PH2	15	500	12.000
TCPA24232	4,2 x 32	19,130	PH2	25	500	6.000

TEX

Tirafondo de alto rendimiento

TEX-A2

Inoxidable A2. Huella TX

INOXIDABLE



CÓDIGO	MEDIDA	€/100			
TEXA250050	5 x 50	27,858	TX25	250	3.000
TEXA250060	5 x 60	33,477	TX25	100	2.400
TEXA250070	5 x 70	40,050	TX25	100	2.400

Caja ventana

CÓDIGO	MEDIDA	€/CAJA	PCS	CAJAS
VTEXA250050	5 x 50	7,569	20	8
VTEXA250060	5 x 60	9,092	20	8
VTEXA250070	5 x 70	10,310	20	8





Tirafondos de cabeza avellanada

TP

INOXIDABLE



CÓDIGO	MEDIDA	€/100			
TPA230016	3 x 16	4,330	PZ1	200	9.000
TPA230025	3 x 25	5,537	PZ1	200	9.000
TPA235020	3,5 x 20	7,295	PZ2	200	9.000
TPA235025	3,5 x 25	7,882	PZ2	200	9.000
TPA235030	3,5 x 30	9,610	PZ2	200	9.000
TPA235040	3,5 x 40	13,663	PZ2	200	4.800
TPA240030	4 x 30	11,681	PZ2	200	4.800
TPA240040	4 x 40	13,793	PZ2	200	4.800
TPA240050	4 x 50	21,645	PZ2	200	4.800
TPA245030	4,5 x 30	13,716	PZ2	200	4.800
TPA245050	4,5 x 50	21,909	PZ2	200	2.400
TPA250050	5 x 50	27,632	PZ2	200	2.400
TPA250070	5 x 70	37,658	PZ2	200	2.400

TP-A2

Inoxidable A2. Huella PZ





Tornillo con rosca para madera y aglomerado. Cabeza hexagonal

DIN-571

INOXIDABLE



CÓDIGO	MEDIDA	€/100			
• TBA206040	6 x 40	29,117	10	100	2.400
• TBA206050	6 x 50	35,387	10	100	1.200
• TBA206060	6 x 60	42,357	10	100	1.200
• TBA206070	6 x 70	45,490	10	100	1.200
• TBA208050	8 x 50	65,997	13	100	1.200
• TBA208060	8 x 60	75,710	13	100	1.200
• TBA208070	8 x 70	87,377	13	100	600
• TBA208080	8 x 80	93,583	13	100	600
• TBA210080	10 x 80	163,663	17	100	400

DIN-571 A2

Inoxidable A2





• Medidas sin homologar

Tornillo inviolable. Huella TX

INV

INOXIDABLE



CÓDIGO	MEDIDA	€/100			
• INVVA27050	7 x 50	119,867	TX40	100	1.200
• INVVA27060	7 x 60	142,010	TX40	100	600
• INVVA27070	7 x 70	157,617	TX40	100	600
• INVVA27080	7 x 80	170,147	TX40	100	600

INV A2

Inoxidable A2



• Medidas sin homologar

DIN-933

Tornillo rosca métrica con cabeza hexagonal 8.8. Rosca completa

DIN-933 A2

INOXIDABLE



Inoxidable A2



CÓDIGO	MEDIDA	€/100				CÓDIGO	MEDIDA	€/100			
D933IM04010	M4 x 10	9,093	7	500	12.000	D933IM10040	M10 x 40	94,335	17	200	-
D933IM04016	M4 x 16	10,890	7	500	12.000	D933IM10050	M10 x 50	103,379	17	200	-
D933IM04020	M4 x 20	12,527	7	500	8.000	D933IM10060	M10 x 60	118,386	17	100	600
D933IM04025	M4 x 25	13,517	7	500	8.000	D933IM10070	M10 x 70	133,539	17	100	400
D933IM04030	M4 x 30	18,118	7	500	6.000	D933IM10080	M10 x 80	157,127	17	100	400
D933IM04035	M4 x 35	19,000	7	250	6.000	D933IM10090	M10 x 90	171,313	17	50	300
D933IM04040	M4 x 40	21,123	7	250	6.000	D933IM10100	M10 x 100	193,297	17	50	300
D933IM05010	M5 x 10	9,497	8	500	8.000	D933IM12020	M12 x 20	106,508	19	100	600
D933IM05016	M5 x 16	11,137	8	500	-	D933IM12030	M12 x 30	110,786	19	100	600
D933IM05020	M5 x 20	12,613	8	500	6.000	D933IM12040	M12 x 40	128,797	19	100	400
D933IM05025	M5 x 25	14,953	8	500	4.000	D933IM12050	M12 x 50	148,635	19	100	400
D933IM05030	M5 x 30	17,893	8	500	4.000	D933IM12060	M12 x 60	169,412	19	100	400
D933IM05035	M5 x 35	19,211	8	250	3.000	D933IM12070	M12 x 70	190,406	19	100	-
D933IM05040	M5 x 40	21,579	8	250	3.000	D933IM12080	M12 x 80	225,610	19	50	300
D933IM05050	M5 x 50	25,553	8	250	3.000	D933IM12090	M12 x 90	247,007	19	50	300
D933IM06010	M6 x 10	15,933	10	250	6.000	D933IM12100	M12 x 100	268,407	19	25	150
D933IM06016	M6 x 16	16,880	10	250	4.000	D933IM14030	M14 x 30	204,223	22	50	300
D933IM06020	M6 x 20	19,557	10	250	4.000	D933IM14040	M14 x 40	253,490	22	50	300
D933IM06025	M6 x 25	20,323	10	250	3.000	D933IM14050	M14 x 50	277,438	22	50	300
D933IM06030	M6 x 30	23,610	10	250	3.000	D933IM14060	M14 x 60	328,437	22	50	200
D933IM06035	M6 x 35	26,700	10	250	2.000	D933IM14070	M14 x 70	330,035	22	50	200
D933IM06040	M6 x 40	32,790	10	250	2.000	D933IM14080	M14 x 80	354,507	22	25	150
D933IM06050	M6 x 50	36,968	10	250	1.500	D933IM14100	M14 x 100	539,080	22	25	150
D933IM08016	M8 x 16	34,613	13	200	1.600	D933IM16030	M16 x 30	265,604	24	50	300
D933IM08020	M8 x 20	35,644	13	200	1.600	D933IM16040	M16 x 40	271,385	24	50	200
D933IM08025	M8 x 25	38,117	13	200	1.600	D933IM16050	M16 x 50	312,188	24	50	200
D933IM08030	M8 x 30	42,380	13	200	1.200	D933IM16060	M16 x 60	320,347	24	50	200
D933IM08035	M8 x 35	46,633	13	200	1.200	D933IM16070	M16 x 70	357,073	24	25	150
D933IM08040	M8 x 40	58,337	13	200	1.200	D933IM16080	M16 x 80	453,421	24	25	150
D933IM08050	M8 x 50	61,937	13	200	800	D933IM16090	M16 x 90	502,047	24	25	150
D933IM08060	M8 x 60	70,693	13	200	800	D933IM16100	M16 x 100	543,837	24	25	100
D933IM08070	M8 x 70	96,006	13	200	800	D933IM18030	M18 x 30	450,847	27	25	100
D933IM08080	M8 x 80	96,820	13	100	600	D933IM18040	M18 x 40	476,837	27	25	200
D933IM08090	M8 x 90	107,270	13	100	600	D933IM18050	M18 x 50	520,883	27	25	150
D933IM08100	M8 x 100	120,357	13	100	600	D933IM18060	M18 x 60	582,160	27	25	150
D933IM10020	M10 x 20	63,470	17	200	800	D933IM18070	M18 x 70	647,253	27	25	100
D933IM10025	M10 x 25	75,439	17	200	800	D933IM18080	M18 x 80	708,547	27	25	100
D933IM10030	M10 x 30	76,921	17	200	800	D933IM18090	M18 x 90	769,830	27	25	100
D933IM10035	M10 x 35	92,976	17	200	800	D933IM18100	M18 x 100	831,110	27	25	100

Blister

CÓDIGO	MEDIDA	€/BOLSA	PCS	BOLSAS
BZ3I04010	M4 x 10	2,582	6	20
BZ3I04016	M4 x 16	2,582	6	20
BZ3I04020	M4 x 20	2,582	6	20
BZ3I04030	M4 x 30	2,582	6	20
BZ3I04040	M4 x 40	2,582	6	20
BZ3I05010	M5 x 10	2,582	6	20
BZ3I05016	M5 x 16	2,582	6	20
BZ3I05020	M5 x 20	2,582	6	20
BZ3I05030	M5 x 30	2,582	6	20
BZ3I05040	M5 x 40	2,582	6	20
BZ3I05050	M5 x 50	2,582	6	20
BZ3I06016	M6 x 16	2,582	6	20
BZ3I06020	M6 x 20	2,582	6	20
BZ3I06025	M6 x 25	2,582	6	20
BZ3I06030	M6 x 30	2,582	6	20
BZ3I06040	M6 x 40	2,582	6	20
BZ3I06050	M6 x 50	2,582	6	20
BZ3I08016	M8 x 16	2,582	4	20
BZ3I08020	M8 x 20	2,582	4	20
BZ3I08025	M8 x 25	2,582	4	20
BZ3I08030	M8 x 30	2,582	4	20
BZ3I08040	M8 x 40	2,582	4	20
BZ3I08050	M8 x 50	2,582	4	20
BZ3I08060	M8 x 60	2,582	4	20
BZ3I10020	M10 x 20	2,582	2	20
BZ3I10030	M10 x 30	2,582	2	20
BZ3I10040	M10 x 40	2,582	2	20

Caja ventana

CÓDIGO	MEDIDA	€/CAJA	PCS	CAJAS
VD933I04010	M4 x 10	5,047	40	8
VD933I04016	M4 x 16	6,045	40	8
VD933I04020	M4 x 20	6,702	40	8
VD933I04030	M4 x 30	6,986	30	8
VD933I04040	M4 x 40	7,061	25	8
VD933I05010	M5 x 10	5,273	40	8
VD933I05016	M5 x 16	6,184	40	8
VD933I05020	M5 x 20	7,001	40	8
VD933I05030	M5 x 30	4,905	20	8
VD933I05040	M5 x 40	5,796	20	8
VD933I05050	M5 x 50	3,919	10	8
VD933I06010	M6 x 10	6,638	30	8
VD933I06016	M6 x 16	6,767	30	8
VD933I06020	M6 x 20	7,842	30	8
VD933I06025	M6 x 25	6,789	25	8
VD933I06030	M6 x 30	8,306	25	8
VD933I06040	M6 x 40	6,470	15	8
VD933I06050	M6 x 50	5,115	10	8
VD933I08016	M8 x 16	9,105	20	8
VD933I08020	M8 x 20	9,372	20	8
VD933I08025	M8 x 25	10,582	20	8
VD933I08030	M8 x 30	8,826	15	8
VD933I08040	M8 x 40	7,520	10	8
VD933I08050	M8 x 50	8,595	10	8
VD933I08060	M8 x 60	9,812	10	8
VD933I10020	M10 x 20	8,809	10	8
VD933I10030	M10 x 30	10,124	10	8
VD933I10040	M10 x 40	11,657	10	8
VD933I10050	M10 x 50	13,884	10	8
VD933I10060	M10 x 60	16,394	10	8

Tornillo cabeza hexagonal con arandela estampada y grafilada 8.8

DIN-6921

METAL



CÓDIGO	MEDIDA	€/100	LLAVE DE INSTALACIÓN		
6921108020	M8 x 20	50,523	13	200	2.400
6921108050	M8 x 50	80,817	13	100	600
6921108070	M8 x 70	117,303	13	100	600

DIN-6921 A2

Tornillo DIN-6921. Tornillo hexagonal con arandela estampada y grafilada. Inoxidable A2



Tornillo con cabeza redonda y cuello cuadrado. Inoxidable A2

DIN-603 A2

METAL



CÓDIGO	MEDIDA	€/100		
D603108016	M8 x 16	42,047	200	2.400



Disponible en varios recubrimientos. Consulte precio y plazo de entrega.

Tuerca hexagonal

DIN-934

INOXIDABLE



CÓDIGO	MEDIDA	€/100	LLAVE DE INSTALACIÓN		
D934IM04	M4	3,590	7	500	22.500
D934IM05	M5	4,150	8	500	12.000
D934IM06	M6	6,850	10	500	12.000
D934IM08	M8	13,897	13	250	4.000
D934IM10	M10	30,997	17	250	2.000
D934IM12	M12	45,447	19	250	1.500
D934IM14	M14	69,167	22	100	800
D934IM16	M16	97,060	24	100	600
D934IM18	M18	154,370	27	100	600
D934IM20	M20	202,697	30	50	400
D934IM22	M22	280,170	32	50	300
D934IM24	M24	364,217	36	25	200

DIN-934 A2

Inoxidable A2



 Blíster

CÓDIGO	MEDIDA	€/BOLSA	PCS 	BOLSAS 
BZ934IM04	M4	2,582	10	20
BZ934IM05	M5	2,582	8	20
BZ934IM06	M6	2,582	8	20
BZ934IM08	M8	2,582	6	20
BZ934IM10	M10	2,582	5	15

 Caja ventana

CÓDIGO	MEDIDA	€/CAJA	PCS 	CAJAS 
VD934IM04	M4	2,799	50	8
VD934IM05	M5	3,237	50	8
VD934IM06	M6	4,806	50	8
VD934IM08	M8	5,850	30	8
VD934IM10	M10	8,700	20	8

DIN-985

Tuerca autoblocante

DIN-985 A2

Inoxidable A2

INOXIDABLE



CÓDIGO	MEDIDA	€/100	LLAVE DE INSTALACIÓN		
D985IM04	M4	6,440	7	500	22.500
D985IM05	M5	6,933	8	500	8.000
D985IM06	M6	9,797	10	500	8.000
D985IM08	M8	20,447	13	250	4.000
D985IM10	M10	41,130	17	250	2.000
D985IM12	M12	63,930	19	100	1.200
D985IM14	M14	121,010	22	100	800
D985IM16	M16	146,667	24	50	600
D985IM18	M18	335,650	27	50	400
D985IM20	M20	430,477	30	25	300
D985IM22	M22	974,347	32	25	300
D985IM24	M24	1.313,707	36	25	150

DIN-6923

Tuerca brida grafilada

DIN-6923 A2

Tuerca brida grafilada DIN-6923.
Inoxidable A2

METAL



CÓDIGO	MEDIDA	€/100	LLAVE DE INSTALACIÓN	Nº HUELLA		
D6923IM08	M8	24,660	13	13	250	3.000
D6923IM10	M10	47,753	15	17	250	3.000
D6923IM12	M12	70,740	18	19	250	1.500

DIN-125

Arandela plana

DIN-125 A2

Inoxidable A2

INOXIDABLE



CÓDIGO	MEDIDA	€/100		
D125IM04	M4	1,217	500	22.500
D125IM05	M5	1,610	500	22.500
D125IM06	M6	2,917	500	22.500
D125IM08	M8	5,003	250	11.250
D125IM10	M10	9,557	250	6.000
D125IM12	M12	19,037	250	3.000
D125IM14	M14	26,643	200	2.400
D125IM16	M16	29,420	100	2.400
D125IM18	M18	43,627	100	1.600
D125IM20	M20	46,327	50	1.200
D125IM22	M22	54,937	50	1.200
D125IM24	M24	96,120	50	600



CÓDIGO	MEDIDA	€/BOLSA	PCS BOLSAS	BOLSAS
BZ125IM04	M4	2,582	10	20
BZ125IM05	M5	2,582	8	20
BZ125IM06	M6	2,582	8	20
BZ125IM08	M8	2,582	6	20
BZ125IM10	M10	2,582	5	20



Caja ventana

CÓDIGO	MEDIDA	€/CAJA	PCS CAJAS	CAJAS
VD125IM04	M4	3,225	100	8
VD125IM05	M5	3,235	75	8
VD125IM06	M6	4,091	75	8
VD125IM08	M8	4,265	50	8
VD125IM10	M10	7,107	50	8

Arandela plana ancha

DIN-9021



INOXIDABLE



DIN-9021 A2

Inoxidable A2



CÓDIGO	MEDIDA	€/100		
D9021IM04	M4	2,460	500	22.500
D9021IM05	M5	4,410	500	12.000
D9021IM06	M6	7,990	500	8.000
D9021IM08	M8	16,463	200	4.800
D9021IM10	M10	35,630	100	1.600
D9021IM12	M12	61,450	100	800
D9021IM14	M14	138,600	100	800
D9021IM16	M16	134,200	50	600
D9021IM18	M18	240,293	50	400
D9021IM20	M20	257,160	25	300
D9021IM22	M22	277,533	25	200
D9021IM24	M24	326,100	25	150



Blíster



Caja ventana

CÓDIGO	MEDIDA	€/BOLSA	PCS BOLSA	BOLSAS
BZ9021IM04	M4	2,582	10	20
BZ9021IM05	M5	2,582	8	20
BZ9021IM06	M6	2,582	8	20
BZ9021IM08	M8	2,582	6	20
BZ9021IM10	M10	2,582	5	20

CÓDIGO	MEDIDA	€/CAJA	PCS CAJA	CAJAS
VD9021IM04	M4	3,667	100	8
VD9021IM05	M5	4,525	75	8
VD9021IM06	M6	8,049	75	8
VD9021IM08	M8	8,623	40	8
VD9021IM10	M10	9,754	20	8

Arandela muelle Grower

DIN-127



METAL



DIN-127 A2

Arandela muelle grower DIN-127.
Inoxidable A2



CÓDIGO	MEDIDA	€/100		
D127IM08	M8	4,530	200	9.000
D127IM10	M10	7,237	100	4.500
D127IM12	M12	10,923	100	4.500

Porta puntas magnético 1/4

PU-PM

METAL



PU-PMI NEW

Inoxidable

CÓDIGO	MEDIDA	€/100	UD. MIN. VENTA		
PUPMI014	1/4" x 60	1.000,000	5	5	225



AB-RE

Abrazadera reforzada M8 + M10

AB-RE A2

Inoxidable A2



INOXIDABLE



CÓDIGO	MEDIDA	ØD(MM)	€/100	CARGA MÁXIMA		
ABREA2018	18 (M8+M10)	15 - 18	381,133	150	50	300
ABREA2022	22 (M8+M10)	20 - 24	392,963	150	50	200
ABREA2028	28 (M8+M10)	26 - 30	443,166	150	50	150
ABREA2035	35 (M8+M10)	32 - 36	461,445	150	50	100
ABREA2040	40 (M8+M10)	36 - 42	487,376	150	25	100
ABREA2048	48 (M8+M10)	47 - 50	514,040	150	25	100
ABREA2054	54 (M8+M10)	51 - 55	542,877	150	25	75
ABREA2060	60 (M8+M10)	60 - 64	560,050	150	25	75
ABREA2075	75 (M8+M10)	75 - 80	623,047	150	25	50
ABREA2090	90 (M8+M10)	87 - 92	666,692	150	25	-
ABREA2110	110 (M8+M10)	106 - 112	736,779	150	25	-
ABREA2115	115 (M8+M10)	114 - 119	784,717	150	25	-
ABREA2125	125 (M8+M10)	124 - 131	824,328	150	25	-
ABREA2140	140 (M8+M10)	133 - 140	988,740	150	25	-
ABREA2160	160 (M8+M10)	159 - 163	1.083,740	150	25	-
ABREA2200	200 (M8+M10)	199 - 212	1.449,991	150	25	-

AB-RE

Abrazadera reforzada M8 + M10

AB-RE A4

Inoxidable A4



INOXIDABLE



CÓDIGO	MEDIDA	ØD(MM)	€/100	CARGA MÁXIMA		
ABREA4018	18 (M8+M10)	15 - 18	461,382	150	50	300
ABREA4022	22 (M8+M10)	20 - 24	473,873	150	50	200
ABREA4028	28 (M8+M10)	26 - 30	506,095	150	50	150
ABREA4035	35 (M8+M10)	32 - 36	559,794	150	50	100
ABREA4040	40 (M8+M10)	36 - 42	583,804	150	25	100
ABREA4048	48 (M8+M10)	47 - 50	648,745	150	25	100
ABREA4054	54 (M8+M10)	51 - 55	676,822	150	25	75
ABREA4060	60 (M8+M10)	60 - 64	701,442	150	25	75
ABREA4075	75 (M8+M10)	75 - 80	800,485	150	25	50
ABREA4090	90 (M8+M10)	87 - 92	829,012	150	25	-
ABREA4110	110 (M8+M10)	106 - 112	973,250	150	25	-
ABREA4115	115 (M8+M10)	114 - 119	1.044,142	150	25	-
ABREA4125	125 (M8+M10)	124 - 131	1.088,679	150	25	-
ABREA4140	140 (M8+M10)	133 - 140	1.338,383	150	25	-
ABREA4160	160 (M8+M10)	159 - 163	1.428,322	150	25	-
ABREA4200	200 (M8+M10)	199 - 212	1.714,167	150	25	-

AB-RI

Abrazadera isofónica reforzada M8 + M10

AB-RI A2

Inoxidable A2



INOXIDABLE



CÓDIGO	MEDIDA	ØD(MM)	€/100	CARGA MÁXIMA		
ABRIA2018	18 (M8+M10)	15 - 18	451,652	150	50	200
ABRIA2022	22 (M8+M10)	20 - 24	464,112	150	50	150
ABRIA2028	28 (M8+M10)	26 - 30	484,763	150	50	150
ABRIA2035	35 (M8+M10)	32 - 36	510,016	150	50	100
ABRIA2040	40 (M8+M10)	36 - 42	560,523	150	25	75
ABRIA2048	48 (M8+M10)	47 - 50	594,062	150	25	75
ABRIA2054	54 (M8+M10)	51 - 55	640,098	150	25	50
ABRIA2060	60 (M8+M10)	60 - 64	674,848	150	25	50
ABRIA2075	75 (M8+M10)	75 - 80	760,267	150	25	-
ABRIA2090	90 (M8+M10)	87 - 92	799,166	150	25	-
ABRIA2110	110 (M8+M10)	106 - 112	902,767	150	25	-
ABRIA2115	115 (M8+M10)	114 - 119	894,469	150	25	-
ABRIA2125	125 (M8+M10)	124 - 131	991,594	150	25	-
ABRIA2140	140 (M8+M10)	133 - 140	1.057,113	150	25	-
ABRIA2160	160 (M8+M10)	159 - 163	1.149,961	150	25	-



Abrazadera isofónica reforzada M8 + M10

AB-RI

02
P. 414
Info
Técnica

INOXIDABLE



AB-RI A4

Inoxidable A4

CÓDIGO	MEDIDA	ØD(MM)	€/100	CARGA MÁXIMA		
ABRIA4018	18 (M8+M10)	15 - 18	572,529	150	50	200
ABRIA4022	22 (M8+M10)	20 - 24	601,895	150	50	150
ABRIA4028	28 (M8+M10)	26 - 30	625,189	150	50	150
ABRIA4035	35 (M8+M10)	32 - 36	675,318	150	50	100
ABRIA4040	40 (M8+M10)	36 - 42	720,756	150	25	75
ABRIA4048	48 (M8+M10)	47 - 50	782,568	150	25	75
ABRIA4054	54 (M8+M10)	51 - 55	829,332	150	25	50
ABRIA4060	60 (M8+M10)	60 - 64	897,729	150	25	50
ABRIA4075	75 (M8+M10)	75 - 80	972,580	150	25	-
ABRIA4090	90 (M8+M10)	87 - 92	1.072,419	150	25	-
ABRIA4110	110 (M8+M10)	106 - 112	1.264,429	150	25	-
ABRIA4115	115 (M8+M10)	114 - 119	1.320,999	150	25	-
ABRIA4125	125 (M8+M10)	124 - 131	1.392,583	150	25	-
ABRIA4140	140 (M8+M10)	133 - 140	1.427,321	150	25	-
ABRIA4160	160 (M8+M10)	159 - 163	1.694,718	150	25	-



Abarcón

AB-ZI

SANEAMIENTO



AB-ZI A2

Inoxidable A2

CÓDIGO	MEDIDA	€/100	CARGA MÁXIMA	Ø VARILLA PULGADAS		
AZA2060500	M6 1/2"	109,780	250	M6	100	600
AZA2060750	M6 3/4"	127,623	250	M6	100	600
AZA2061000	M6 1"	157,233	250	M6	100	400
AZA2061250	M6 1 1/4"	186,167	250	M6	50	300
AZA2081500	M8 1 1/2"	323,520	350	M8	50	150
AZA2082000	M8 2"	376,290	350	M8	50	150
AZA2082500	M8 2 1/2"	423,973	350	M8	50	100
AZA2083000	M8 3"	460,830	350	M8	50	100
AZA2104000	M10 4"	937,600	350	M10	50	-
AZA2106000	M10 6"	1.209,237	350	M10	25	-
AZA2108000	M10 8"	1.446,647	350	M10	25	-



Abrazadera M6

AB-M6



02
P. 418
Info
Técnica

INOXIDABLE



AB-M6 A2

Inoxidable A2

CÓDIGO	MEDIDA	ØD(MM)	€/100	CARGA MÁXIMA		
ABM6A2012	12 (M6)	12	269,863	70	100	1.200
ABM6A2015	15 (M6)	14 - 15	274,740	70	100	600
ABM6A2018	18 (M6)	16 - 18	279,617	70	100	600
ABM6A2020	20 (M6)	19 - 21	285,207	70	100	600
ABM6A2022	22 (M6)	22 - 24	288,820	70	100	600
ABM6A2028	28 (M6)	25 - 30	305,037	70	100	400



AB-SF

Abrazadera sin fin

AB-SF A2

Inoxidable A2



02 Info
P. 424 Técnica

INOXIDABLE



CÓDIGO	MEDIDA	ØD(MM)	€/100		
ASF2010016	10-16	10-16	95,663	100	1.200
ASF2012020	12-20	12-20	98,043	100	600
ASF2016027	16-27	16-27	102,270	100	600
ASF2020032	20-32	20-32	115,347	100	600
ASF2025040	25-40	25-40	126,033	100	200
ASF2032050	32-50	32-50	175,423	100	300
ASF2040060	40-60	40-60	186,260	100	200
ASF2050070	50-70	50-70	194,387	50	100
ASF2060080	60-80	60-80	204,343	50	100
ASF2070090	70-90	70-90	215,207	50	100
ASF2080100	80-100	80-100	222,420	50	100
ASF2090110	90-110	90-110	259,380	50	100
ASF2100120	100-120	100-120	269,563	25	75
ASF2110130	110-130	110-130	279,720	25	50
ASF2120140	120-140	120-140	293,967	25	75
ASF2130150	130-150	130-150	305,160	25	50

AB-SF IR

Abrazadera sin fin inoxidable en rollo

AB-SF IR

Kit (Rollo 3 m. + 8 cabezales).
Inoxidable



INOXIDABLE



CÓDIGO	MEDIDA	€/PC		
ASFIR03	9 x 0,6 mm/ 3 m	14,867	1	50

AB-SF IRC

Cabezal inoxidable



INOXIDABLE



CÓDIGO	MEDIDA	€/100		
ASFIRCA	Cabezal	106,197	50	1.000

AB-SF IRR

Rollo 30 m. Inoxidable



INOXIDABLE



CÓDIGO	MEDIDA	€/PC		
ASFIR30	9 x 0,6 mm/ 30 m	53,097	1	10



Cinta perforada

CI-PE



INOXIDABLE



CÓDIGO	MEDIDA	€/PC		
CIPEA21708	17 x 0,8 x 10 m	38,243	1	30

CI-PE A2

Cinta perforada curva. Inoxidable A2





Abrazadera inoxidable Indextube

AB-IT

SANEAMIENTO



CÓDIGO	MEDIDA	€/100		
ABITS015	15	193,863	100	600
ABITS018	18	210,063	100	400
ABITS022	22	311,367	100	400
ABITS028	28	418,547	100	300



AB-ITS

Simple



SANEAMIENTO



CÓDIGO	MEDIDA	€/100		
ABITD015	15	716,737	50	300
ABITD018	18	811,463	50	200
ABITD022	22	1.016,350	50	100

AB-ITD

Doble



Perfiles para cargas ligeras tipo "C"

GP

INOXIDABLE



CÓDIGO	MEDIDA	€/100	
GPI271812	27 x 18 x 1,25 x 2000	11.696,187	6
GPI283015	28 x 30 x 1,50 x 2000	18.898,133	6
GPI384020	38 x 40 x 2,00 x 2000	39.110,867	5

GP-A2

Guía perforada inoxidable A2



PE-AC

Accesorios para perfiles tipo "C"

EG-A2

Escuadra inoxidable A2



INOXIDABLE



CÓDIGO	MEDIDA	€/100		
EMI45	50 x 50 45°	653,707	50	200
EMI90	54 x 54 90°	653,707	50	-
EMI00	100 180°	648,100	50	200

PG-A2

Puente guía inoxidable A2



INOXIDABLE



CÓDIGO	MEDIDA	€/100		
PGI2718	27 / 18 x 81	318,853	50	300
PGI2830	28 / 30 x 81	366,683	50	200
PGI3840	38 / 40 x 93	446,397	50	100

ISF-GG

Grapas y galgas para montaje de placas

KFR-SC

Grapa fijación rápida



METAL



CÓDIGO	MEDIDA	€/100		
KFRSC3050	30 - 50	583,910	10	240

NEW KFR-SCN

Grapa fijación rápida. Negra



METAL



CÓDIGO	MEDIDA	€/100		
KFRSCN3050	30 - 50	636,463	10	240

NEW KFR-SS

Grapa fijación simple



METAL



CÓDIGO	MEDIDA	€/100		
KFRSS0850	8 x 50	331,640	10	60
KFRSS0870	8 x 70	357,153	10	60

METAL



CÓDIGO	MEDIDA	€/PC	MEDIDA TORNILLO	
EMPXSD4115	41 x 1,5	15,261	M8x16	1

EMP-XSD NEW

Empalme INDEXTRUT solar con tornillo DIN-603 A2 y tuerca DIN-6923 A2. Válido para guía GP-XS



Componentes: EMPXS4115 x 2
D603108016 x 4
69231M08 x 4

METAL



CÓDIGO	MEDIDA	€/PC	MEDIDA TORNILLO	
PSAUNT200	200	11,100	M5,5 x 19,0	1

PSA-UNT NEW

Unión de aluminio para perfil PSA-A con tornillo DIN-7504-K A2. Válido para guía PSA-A. Gültig für PSA-A Lochführung



Componentes: PSAUN200 x 2
ABE15519 x 8

METAL



CÓDIGO	MEDIDA	€/PC	MEDIDA TORNILLO	
PSEUNT60200	60 x 200	14,694	M 5,5 x 19,0	1

PSE-UNT NEW

Unión de aluminio para perfil PSE-A con tornillo DIN-7504-K A2



Componentes: PSEUN60200 x 2
ABE15519 x 8

METAL



CÓDIGO	MEDIDA	€/PC	MEDIDA TORNILLO		
PSECUNT200	200	10,130	5,5 x 19	1	20

PSE-CUNT NEW

Unión de aluminio para perfil PSE-C con tornillo DIN-7504-K A2. Válido para guía PSE-C



Componentes: PSECUN200 x 2
ABE15519 x 8

ISF-CC

Conectores + Complementos para montaje de estructuras solares

DIN-6921 A2

Tornillo DIN-6921. Tornillo hexagonal con arandela estampada y grafilada. Inoxidable A2



METAL



CÓDIGO	MEDIDA	€/100	LLAVE DE INSTALACIÓN		
692108020	M8 x 20	50,523	13	200	2.400
692108050	M8 x 50	80,817	13	100	600
692108070	M8 x 70	117,303	13	100	600

DIN-603 A2

Tornillo DIN-603. Cabeza redonda y cuello cuadrado. Inoxidable A2



METAL



CÓDIGO	MEDIDA	€/100		
D60308016	M8 x 16	42,047	200	2.400



Disponible en varios recubrimientos. Consulte precio y plazo de entrega.

DIN-6923 A2

Tuerca brida grafilada DIN-6923. Inoxidable A2



METAL



CÓDIGO	MEDIDA	€/100	LLAVE DE INSTALACIÓN	Nº HUELLA		
D6923IM08	M8	24,660	13	13	250	3.000
D6923IM10	M10	47,753	15	17	250	3.000
D6923IM12	M12	70,740	18	19	250	1.500

DIN-127 A2

Arandela muelle grower DIN-127. Inoxidable A2



METAL



CÓDIGO	MEDIDA	€/100		
D127IM08	M8	4,530	200	9.000
D127IM10	M10	7,237	100	4.500
D127IM12	M12	10,923	100	4.500

KFS-FI

Conector cruzado para fijación inferior. Inoxidable A2



METAL





CÓDIGO	MEDIDA	€/100		
KFSFIM08	M8	141,570	100	900

Conectores + Complementos para montaje de estructuras solares

ISF-CC

METAL



CÓDIGO	MEDIDA	€/100		
TURXA208	M8	141,600	50	300

TU-RX A2

Tuerca rápida INDEXTRUT. Inoxidable A2



Accesorios regulables para la instalación de placas solares

ISF-FR

METAL

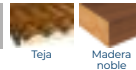

CÓDIGO	MEDIDA	€/100	LLAVE DE INSTALACIÓN		
KFSMA10200	10 x 200	509,034	7	25	150
KFSMA102002 NEW	10 x 200	559,936	7	2	-
KFSMA102010 NEW	10 x 200	534,485	7	10	40
KFSMA10250	10 x 250	529,474	7	25	150
KFSMA102502 NEW	10 x 250	580,186	7	2	-
KFSMA102510 NEW	10 x 250	563,921	7	10	20
KFSMA12300	12 x 300	1.113,006	9	25	75
KFSMA12350	12 x 350	1.321,193	9	25	75

KFS-MA

Espárrago doble rosca. Inoxidable A2



METAL



CÓDIGO	MEDIDA	€/100	LLAVE DE INSTALACIÓN		
KFSAU10160	10 x 160	2.071,968	13	25	150
KFSAU10200	10 x 200	2.404,101	13	25	75

KFS-AU

Kit tornillo autorroscante. Inoxidable A2



METAL

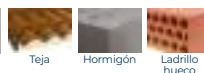

CÓDIGO	MEDIDA	€/100	LLAVE DE INSTALACIÓN		
KFSRV10250	10 x 250	529,474	7	25	150
KFSRV12350	12 x 350	1.228,877	9	25	75

KFS-RV

Varilla roscada para instalación con anclaje químico. Inoxidable A2



METAL



CÓDIGO	MEDIDA	€/100	
GSTC040080	40 - 80	2.419,966	20
GSTC040801 NEW	40 - 80	2.782,962	1
GSTC040810 NEW	40 - 80	2.589,366	10
GSTC080120	80 - 120	2.465,763	20
GSTC081201 NEW	80 - 120	2.835,630	1
GSTC081210 NEW	80 - 120	2.638,369	10

GS-TC

Gancho salvateja ajustable para teja curva. Inoxidable A2



ISF-FR

Accesorios regulables para la instalación de placas solares

GS-TU

Gancho salvateja ajustable para teja universal. Inoxidable A2



METAL



CÓDIGO	MEDIDA	€/100	
GSTU040055	40 - 55	2.614,391	20
GSTU040501 NEW	40 - 55	3.006,549	1
GSTU040510 NEW	40 - 55	2.797,398	10

NEW GS-TP

Gancho salvateja para teja plana. Inoxidable A2



METAL



CÓDIGO	MEDIDA	€/100	
GSTP075100	75 - 100	1.427,800	20
GSTP120145	120 - 145	1.903,733	20

NEW GS-PI

Gancho salvateja para teja de pizarra. Inoxidable A2



METAL



CÓDIGO	MEDIDA	€/100	
GSPI040065	40 - 65	1.308,817	20
GSPI090115	90 - 115	1.856,140	20

STR

Soporte regulable para perfil trapezoidal. Inoxidable A2



METAL



CÓDIGO	MEDIDA	€/100	
STR1680	16 - 80	1.769,204	40

PMO

Placa para tornillo doble rosca. Inoxidable A2



METAL



CÓDIGO	MEDIDA	€/100		
PMO1012	M10 -M12	263,027	25	300

Accesorios regulables para la instalación de placas solares

ISF-FR

METAL



CÓDIGO	MEDIDA	€/100	
PMOD101202	M10 - M12	412,333	2
PMOD101210	M10 - M12	352,667	10

PMO-D NEW

Placa para tornillo doble rosca con tornillo DIN-603 A2 y tuerca DIN-6923 A2



Componentes. PMOI012x1
D603I08016x1
D6923I08x1

METAL



CÓDIGO	MEDIDA	€/100	
PMOK101202	M10 - M12	525,000	2
PMOK101210	M10 - M12	449,333	10

PMO-K NEW

Placa para tornillo doble rosca con conector cruzado para fijación inferior. Inoxidable A2



Componentes. PMOI012x1
KFSFIM08x1

METAL



CÓDIGO	MEDIDA	€/100	
PMOLK101202	M10 - M12	379,764	2
PMOLK101210	M10 - M12	325,116	10

PMO-LK NEW

Pletina en "L" de aluminio para fijación lateral con conector cruzado para fijación inferior. Válida para perfil PSE-C





Componentes. PMOI012x1
KFSFIM08x1

Accesorios de fijación directa para la instalación de placas solares

ISF-FD

METAL



CÓDIGO	MEDIDA	€/100		ESPESOR MÁX. A FIJAR (MM)	CAPACIDAD DE TALADRO		
PST1655060	5,5 / 6,3 x 60 P16	56,360	8	31 - 45	1,50-6,00	100	1.200
PST1655082	5,5 / 6,3 x 82 P16	66,557	8	43 - 67	1,50-6,00	100	600
PST1655098	5,5 / 6,3 x 98 P16	72,273	8	54 - 83	1,50-6,00	100	600
PST1655115	5,5 / 6,3 x 115 P16	86,140	8	56 - 100	1,50-6,00	100	600

PST 3 + ARVUL NEW
A2

Tornillo con punta broca estándar #3 con recubrimiento ATLANTIS C4-M y arandela inoxidable A2



ISF-FD

Accesorios de fijación directa para la instalación de placas solares

NEW **PST 5 + ARVUL**
A2

Tornillo con punta broca extra larga #5 con recubrimiento ATLANTIS C4-M y arandela inoxidable A2



CÓDIGO	MEDIDA	€/100		ESPESOR MÁX. A FIJAR (MM)	CAPACIDAD DE TALADRO		
PSTL1655075	5,5 / 6,3 x 75 P16	63,827	8	33 - 60	6,00-12,00	100	1.200
PSTL1655085	5,5 / 6,3 x 85 P16	70,980	8	38 - 70	6,00-12,00	100	600
PSTL1655105	5,5 / 6,3 x 105 P16	87,957	8	48 - 90	6,00-12,00	100	600
PSTL1655130	5,5 / 6,3 x 130 P16	114,480	8	63 - 115	6,00-12,00	100	600

TAC BIMETAL +
ARVUL A2

Tornillo de cosido Bimetal + Arandela vulcanizada EPDM-inoxidable A2



CÓDIGO	MEDIDA	€/100	Nº HUELLA		
TACB166025	6 x 25 P16	92,799	8	500	2.000

ISF-ES

Accesorios de estanqueidad para la instalación de placas solares

ARS-P

Arandela paraguas inoxidable A2 + EPDM



CÓDIGO	MEDIDA	€/100		
ARSP08	M8	47,727	100	1.200
ARSP10	M10	47,727	100	1.200

ISF-KT

Kits para instalaciones solares

KT-PSE

Triangular con perfil de aluminio PSE-A. Fijación ensamblada



CÓDIGO	MEDIDA	€/PC	
KTPSE0230	x2 (30 mm) - ORIGEN	365,517	1
KTPSE0235	x2 (35 mm) - ORIGEN	365,517	1
KTPSE0240	x2 (40 mm) - ORIGEN	365,517	1
KTPSE02AM	x2 - AMPLIACION	360,871	1
KTPSE0330	x3 (30 mm) - ORIGEN	520,397	1
KTPSE0335	x3 (35 mm) - ORIGEN	520,397	1
KTPSE0340	x3 (40 mm) - ORIGEN	520,397	1
KTPSE03AM	x3 - AMPLIACION	508,006	1



Kits para instalaciones solares

ISF-KT

METAL



KT-PSC NEW

Triangular con perfil de aluminio
PSE-C. Fijación ensamblada

CÓDIGO	MEDIDA	€/PC	
KTPSC0230	x2 (30 mm) - ORIGEN	316,884	1
KTPSC0235	x2 (35 mm) - ORIGEN	316,884	1
KTPSC0240	x2 (40 mm) - ORIGEN	316,884	1
KTPSC02AM	x2 - AMPLIACION	309,683	1
KTPSC0330	x3 (30 mm) - ORIGEN	439,317	1
KTPSC0335	x3 (35 mm) - ORIGEN	439,317	1
KTPSC0340	x3 (40 mm) - ORIGEN	439,317	1
KTPSC03AM	x3 - AMPLIACION	432,115	1



Varilla roscada

RV

INOXIDABLE



RV-A2

Inoxidable A2. 1 metro

CÓDIGO	MEDIDA	€/100	PASO	
975A2M04	M4 x 1000	359,840	0.7	1
975A2M05	M5 x 1000	424,307	0.8	1
975A2M06	M6 x 1000	585,823	1	1
975A2M08	M8 x 1000	950,680	1.25	1
975A2M10	M10 x 1000	1.377,197	1.5	1
975A2M12	M12 x 1000	2.096,627	1.75	1
975A2M14	M14 x 1000	3.671,453	2	1
975A2M16	M16 x 1000	4.239,507	2	1
975A2M18	M18 x 1000	4.624,917	2.5	1
975A2M20	M20 x 1000	6.382,387	2.5	1
975A2M22	M22 x 1000	7.460,763	2.5	1
975A2M24	M24 x 1000	10.070,977	3	1
975A2M27	M27 x 1000	12.137,603	3	1
975A2M30	M30 x 1000	18.890,203	3.5	1
975A2M33	M33 x 1000	23.715,537	3.5	1
975A2M36	M36 x 1000	27.276,713	4	1



Manguito de unión



MA

INOXIDABLE



MA-RI

Redondo. Inoxidable A2

CÓDIGO	MEDIDA	€/100		
MARI0830	M8 x 30	204,683	100	2.400
MARI1030	M10 x 30	281,790	100	-



Tirafondo abrazadera y grapa

TAG

 Info Técnica
P. 433

INOXIDABLE



AB-TA A2

Inoxidable A2

CÓDIGO	MEDIDA	€/100		
ABTA20630	M6 x 30	84,600	100	2.400



ES-DR

Espárrago de doble rosca

ES-DA2

Inoxidable A2. TX



INOXIDABLE



CÓDIGO	MEDIDA	€/100	LLAVE DE INSTALACIÓN		
ESDA208060	M8 x 60	123,333	6	100	800
ESDA210060	M10 x 60	208,583	8	100	800

PF

Pletina de fijación

PF-A4

Inoxidable A4

INOXIDABLE



CÓDIGO	MEDIDA	€/100		
PFA4M0800	M8	303,137	100	600
PFA4M0810	M8 + M10	361,303	100	600
PFA4M1000	M10	346,320	100	600

SA

Soportes de fijación para sanitarios

SA-IL

Fijación de WC y bidé con taco largo.
2 PCS x KIT

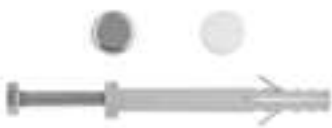

SANEAMIENTO Hormigón Hormigón hueco Ladrillo macizo Hormigón celular Ladrillo hueco Piedra

CÓDIGO	MEDIDA	€/KIT	
SAILO6080	M6 x 80	2,926	100

SA

Soportes de fijación para sanitarios

SA-CI

Fijación de cisterna. 2 PCS x KIT



SANEAMIENTO Hormigón Hormigón hueco Ladrillo macizo Hormigón celular Ladrillo hueco Piedra

CÓDIGO	MEDIDA	€/KIT	
SACIO6080	M6 x 80	5,899	100



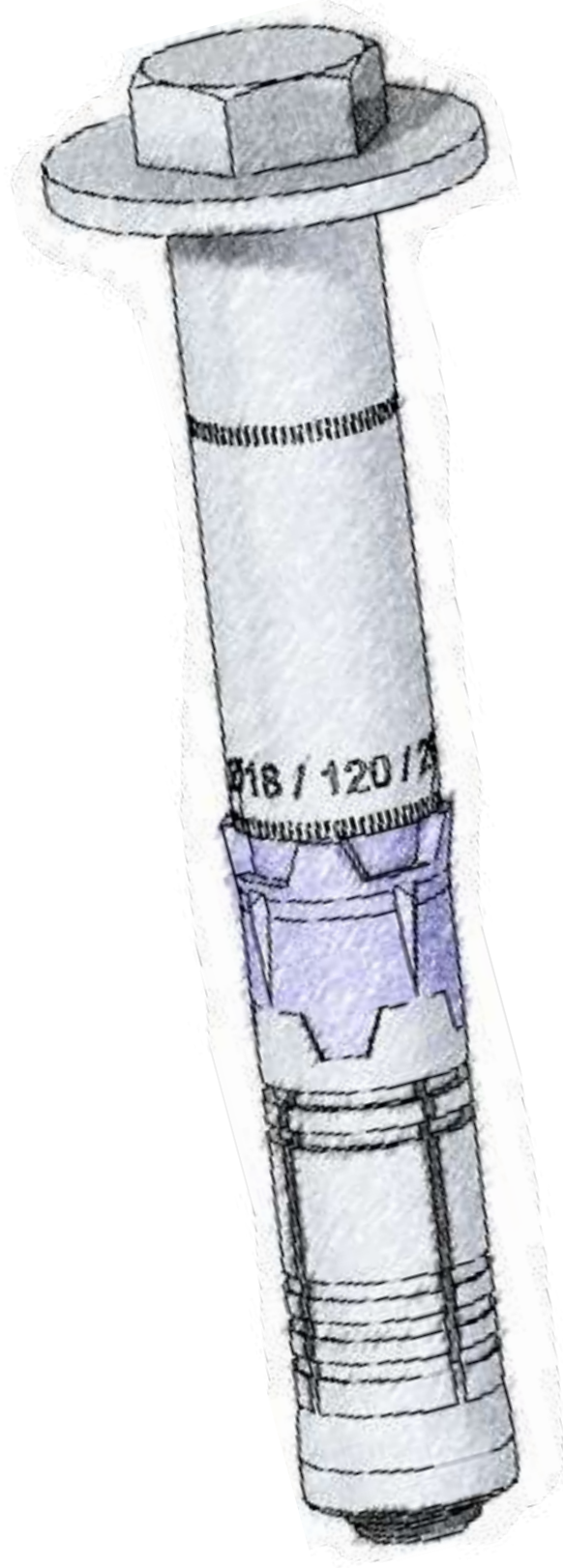
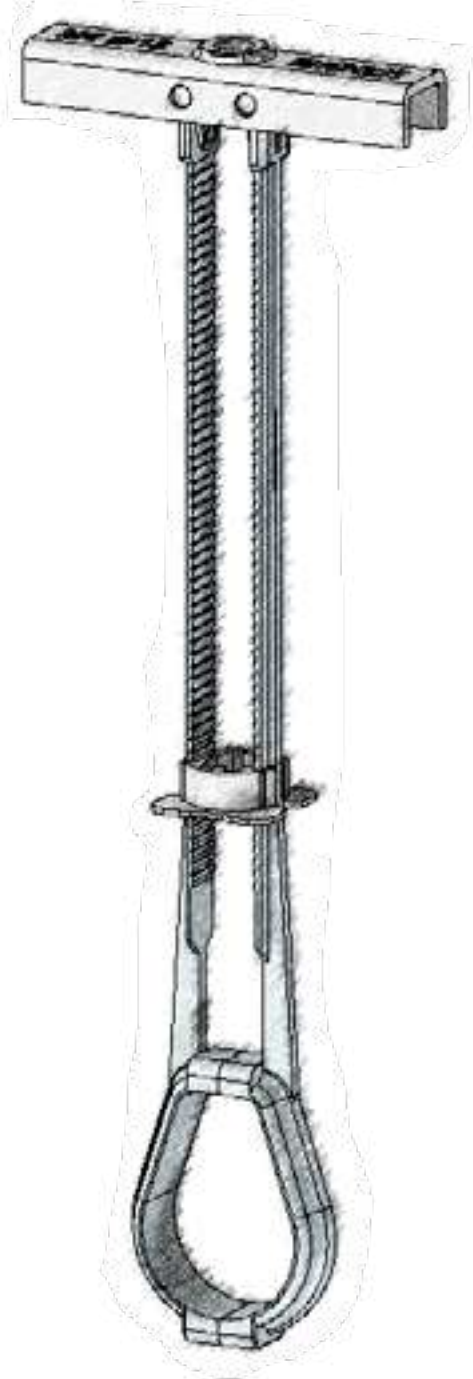
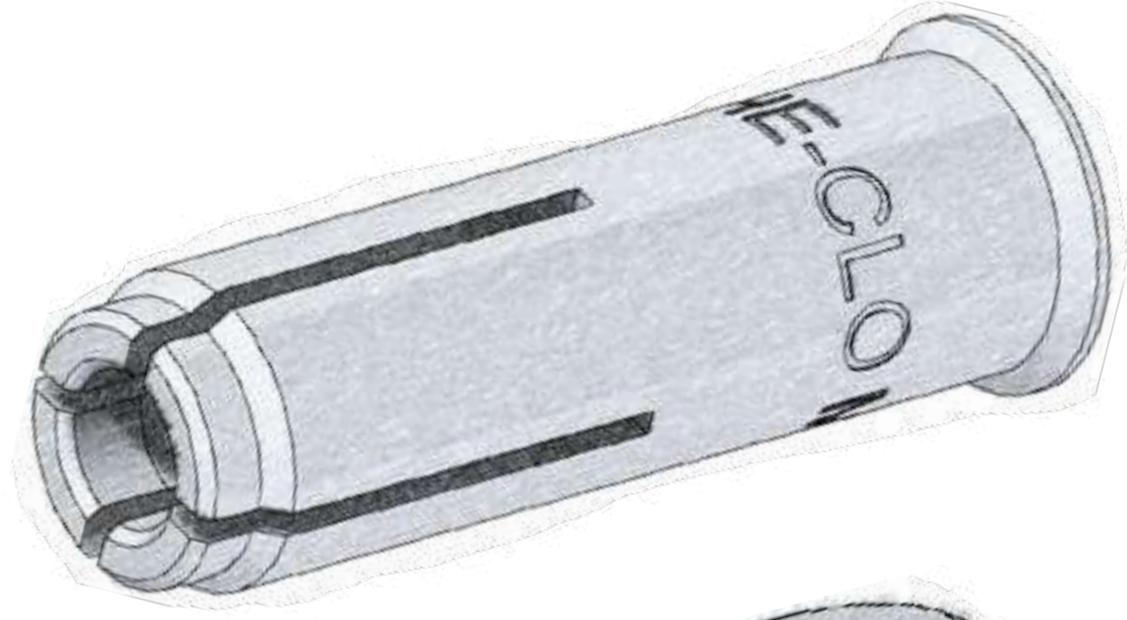

CARACTERÍSTICAS TÉCNICAS

PARÁMETROS TÉCNICOS DE INSTALACIÓN

En las siguientes páginas encontrarás una serie de datos de consulta rápida que te ayudarán a elegir el producto adecuado para tu instalación. Si deseas ampliar esta información puedes consultar nuestra documentación técnica en: www.indexfix.com

Los datos que primero encontrarás son de carácter descriptivo y nos ayudan a entender la geometría del anclaje y su código de referencia correspondiente. Los siguientes son parámetros de instalación del producto, utilizando como unidades de distancia los mm, kg para las cargas máximas recomendadas y Nm para el par de apriete de los anclajes.

La mayoría de productos vienen acompañados de un croquis acotado, el significado de estas cotas para los anclajes se describe a continuación:

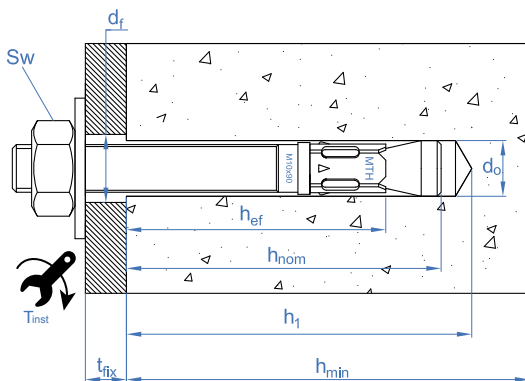

d_o	diámetro de broca o diámetro del taladro [mm]
h_1	profundidad mínima del taladro o agujero [mm]
h_{min}	espesor mínimo del material base [mm]
d_f	diámetro del agujero del elemento a fijar [mm]
h_{nom}	profundidad de instalación del anclaje [mm]
t_{fix}	espesor máximo a fijar [mm]
t_{inst}	par de apriete necesario para la correcta expansión del anclaje [Nm]
C_{cr}	distancia crítica al borde [mm]
S_c	distancia crítica entre anclajes [mm]
h_{ef}	profundidad efectiva del anclaje [mm]
SW	llave de instalación o distancia entre caras de la tuerca [mm]

EXTRACCIÓN

Carga máxima recomendada a tracción que puede resistir el anclaje. Ésta ha sido calculada aplicando un factor de seguridad 1.4 a la resistencia de cálculo del anclaje y está expresada en kg. Este factor aplica para hormigón fisurado y no fisurado. Para otros materiales el factor de seguridad puede llegar hasta 2.5.

CIZALLADURA

Carga máxima recomendada a cortante que puede resistir el anclaje. Ésta ha sido calculada aplicando un factor de seguridad 1.4 a la resistencia de cálculo del anclaje y está expresada en kg. Este factor aplica para hormigón fisurado y no fisurado. Para otros materiales el factor de seguridad puede llegar hasta 2.5.

MTP

Anclaje macho para cargas altas en hormigón fisurado y no fisurado

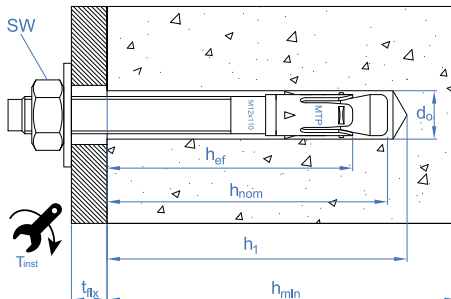

MTP

Homologado ETE Opt.1. Eje cincado. Clip Inoxidable A4

CÓDIGO	MXL	ESPEJOR MÁX. A FIJAR	Ø BROCA	PROFUNDIDAD MÍN. DE TALADRO	PROFUNDIDAD MÍN. DEL ANCLAJE	LLAVE DE INSTALACIÓN	PAR DE APRIETE (NM)	LETRA EJE	Ø ELEMENTO A FIJAR	MÍN. ESPEJOR MATERIAL BASE	DISTANCIA MÍN. AL BORDE "A"	DISTANCIA MÍN. ENTRE EJES "B"	EXTRACCIÓN HORMIGÓN NO-FISURADO	CIZALLADURA HORMIGÓN NO-FISURADO	EXTRACCIÓN HORMIGÓN FISURADO	CIZALLADURA HORMIGÓN FISURADO
AP08050	M8 x 50	2	8	40	37	13	20	A	9	100	72	144	182	392	130	275
AP08075	M8 x 75	9	8	60	55	13	20	C	9	100	72	144	364	641	202	556
AP08095	M8 x 95	29	8	60	55	13	20	E	9	100	72	144	364	641	202	556
AP08115	M8 x 115	49	8	60	55	13	20	G	9	100	72	144	364	641	202	556
AP10090	M10 x 90	10	10	75	68	17	40	E	12	120	90	180	874	1014	461	1014
AP10105	M10 x 105	25	10	75	68	17	40	F	12	120	90	180	874	1014	461	1014
AP10115	M10 x 115	35	10	75	68	17	40	G	12	120	90	180	874	1014	461	1014
AP10135	M10 x 135	55	10	75	68	17	40	H	12	120	90	180	874	1014	461	1014
AP10165	M10 x 165	85	10	75	68	17	40	K	12	120	90	180	874	1014	461	1014
AP10185	M10 x 185	105	10	75	68	17	40	L	12	120	90	180	874	1014	461	1014
AP12080	M12 x 80	4	12	65	60	19	60	D	14	100	105	210	585	1474	417	1182
AP12100	M12 x 100	4	12	85	80	19	60	E	14	140	105	210	971	1474	582	1474
AP12110	M12 x 110	14	12	85	80	19	60	F	14	140	105	210	971	1474	582	1474
AP12120	M12 x 120	24	12	85	80	19	60	G	14	140	105	210	971	1474	582	1474
AP12130	M12 x 130	34	12	85	80	19	60	H	14	140	105	210	971	1474	582	1474
AP12150	M12 x 150	54	12	85	80	19	60	I	14	140	105	210	971	1474	582	1474
AP12180	M12 x 180	84	12	85	80	19	60	L	14	140	105	210	971	1474	582	1474
AP12200	M12 x 200	104	12	85	80	19	60	M	14	140	105	210	971	1474	582	1474
AP16145	M16 x 145	28	16	105	97	24	100	I	18	170	128	255	1747	2744	1214	2620
AP16175	M16 x 175	58	16	105	97	24	100	K	18	170	128	255	1747	2744	1214	2620
AP16220	M16 x 220	103	16	105	97	24	100	O	18	170	128	255	1747	2744	1214	2620
AP16250	M16 x 250	133	16	105	97	24	100	Q	18	170	128	255	1747	2744	1214	2620
AP20170	M20 x 170	32	20	125	114	30	200	K	22	200	150	300	2330	4258	1553	3343
AP20200	M20 x 200	62	20	125	114	30	200	N	22	200	150	300	2330	4258	1553	3343
AP24205	M24 x 205	35	24	155	143	36	250	N	26	250	188	375	2225	4934	1416	4672
AP24235	M24 x 235	65	24	155	143	36	250	P	26	250	188	375	2225	4934	1416	4672

MTP-A4

Homologado ETE Opt.1. Eje inoxidable A4. Clip Inoxidable A4

CÓDIGO	MXL	ESPEJOR MÁX. A FIJAR	Ø BROCA	PROFUNDIDAD MÍN. DE TALADRO	PROFUNDIDAD MÍN. DEL ANCLAJE	LLAVE DE INSTALACIÓN	PAR DE APRIETE (NM)	LETRA EJE	Ø ELEMENTO A FIJAR	MÍN. ESPEJOR MATERIAL BASE	DISTANCIA MÍN. AL BORDE "A"	DISTANCIA MÍN. ENTRE EJES "B"	EXTRACCIÓN HORMIGÓN NO-FISURADO	CIZALLADURA HORMIGÓN NO-FISURADO	EXTRACCIÓN HORMIGÓN FISURADO	CIZALLADURA HORMIGÓN FISURADO
APA408075	M8 x 75	9	8	60	55	13	15	C	9	100	144	72	582	693	413	556
APA408095	M8 x 95	29	8	60	55	13	15	E	9	100	144	72	582	693	413	556
APA408115	M8 x 115	49	8	60	55	13	15	G	9	100	144	72	582	693	413	556
APA408135	M8 x 135	69	8	60	55	13	15	H	9	100	144	72	582	693	413	556
APA410090	M10 x 90	10	10	75	68	17	30	E	12	120	180	90	777	1101	680	1101
APA410105	M10 x 105	25	10	75	68	17	30	F	12	120	180	90	777	1101	680	1101
APA410115	M10 x 115	35	10	75	68	17	30	G	12	120	180	90	777	1101	680	1101
APA410135	M10 x 135	55	10	75	68	17	30	H	12	120	180	90	777	1101	680	1101
APA410165	M10 x 165	85	10	75	68	17	30	K	12	120	180	90	777	1101	680	1101
APA410185	M10 x 185	105	10	75	68	17	30	L	12	120	180	90	777	1101	680	1101
APA412110	M12 x 110	14	12	85	80	19	60	F	14	140	210	105	890	1596	769	1596
APA412120	M12 x 120	24	12	85	80	19	60	G	14	140	210	105	890	1596	769	1596
APA412130	M12 x 130	34	12	85	80	19	60	H	14	140	210	105	890	1596	769	1596
APA412150	M12 x 150	54	12	85	80	19	60	I	14	140	210	105	890	1596	769	1596
APA412180	M12 x 180	84	12	85	80	19	60	L	14	140	210	105	890	1596	769	1596
APA412200	M12 x 200	104	12	85	80	19	60	M	14	140	210	105	890	1596	769	1596
APA416125	M16 x 125	8	16	105	97	24	100	G	18	170	255	128	1559	3204	1092	2620
APA416145	M16 x 145	28	16	105	97	24	100	I	18	170	255	128	1559	3204	1092	2620
APA416175	M16 x 175	58	16	105	97	24	100	K	18	170	255	128	1559	3204	1092	2620
APA416190	M16 x 190	73	16	105	97	24	100	L	18	170	255	128	1559	3204	1092	2620
APA416220	M16 x 220	103	16	105	97	24	100	O	18	170	255	128	1559	3204	1092	2620
APA420200	M20 x 200	62	20	125	114	30	200	M	22	200	300	150	1990	4776	1393	3343
APA420240	M20 x 240	102	20	125	114	30	200	P	22	200	300	150	1990	4776	1393	3343
APA420285	M20 x 285	147	20	125	114	30	200	S	22	200	300	150	1990	4776	1393	3343

MTP-AT

Homologado ETE Opt.1. Eje ATLANTIS C4-M. Clip inoxidable

CÓDIGO	MXL	ESPEJOR MÁX. A FIJAR	Ø BROCA	PROFUNDIDAD MÍN. DE TALADRO	PROFUNDIDAD MÍN. DEL ANCLAJE	LLAVE DE INSTALACIÓN	PAR DE APRIETE (NM)	LETRA EJE	Ø ELEMENTO A FIJAR	MÍN. ESPEJOR MATERIAL BASE	DISTANCIA MÍN. AL BORDE "A"	DISTANCIA MÍN. ENTRE EJES "B"	EXTRACCIÓN HORMIGÓN NO-FISURADO	CIZALLADURA HORMIGÓN NO-FISURADO	EXTRACCIÓN HORMIGÓN FISURADO	CIZALLADURA HORMIGÓN FISURADO
APAT08075	M8 x 75	9	8	60	55	13	20	C	9	100	72	144	364	641	202	556
APAT08095	M8 x 95	29	8	60	55	13	20	E	9	100	72	144	364	641	202	556
APAT08115	M8 x 115	49	8	60	55	13	20	G	9	100	72	144	364	641	202	556
APAT10090	M10 x 90	10	10	75	68	17	40	E	12	120	90	180	874	1014	461	1014
APAT10105	M10 x 105	25	10	75	68	17	40	F	12	120	90	180	874	1014	461	1014
APAT10115	M10 x 115	35	10	75	68	17	40	G	12	120	90	180	874	1014	461	1014
APAT10135	M10 x 135	55	10	75	68	17	40	H	12	120	90	180	874	1014	461	1014
APAT10165	M10 x 165	85	10	75	68	17	40	K	12	120	90	180	874	1014	461	1014
APAT10185	M10 x 185	105	10	75	68	17	40	L	12	120	90	180	874	1014	461	1014
APAT12100	M12 x 100	4	12	85	80	19	60	E	14	140	105	210	971	1474	582	1474
APAT12110	M12 x 110	14	12	85	80	19	60	F	14	140	105	210	971	1474	582	1474
APAT12120	M12 x 120	24	12	85	80	19	60	G	14	140	105	210	971	1474	582	1474
APAT12130	M12 x 130	34	12	85	80	19	60	H	14	140	105	210	971	1474	582	1474
APAT12150	M12 x 150	54	12	85	80	19	60	I	14	140	105	210	971	1474	582	1474
APAT12180	M12 x 180	84	12	85	80	19	60	L	14	140	105	210	971	1474	582	1474
APAT12200	M12 x 200	104	12	85	80	19	60	M	14	140	105	210	971	1474	582	1474
APAT16145	M16 x 145	28	16	105	97	24	100	I	18	170	128	255	1747	2744	1214	2620
APAT16175	M16 x 175	58	16	105	97	24	100	K	18	170	128	255	1747	2744	1214	2620
APAT16220	M16 x 220	103	16	105	97	24	100	O	18	170	128	255	1747	2744	1214	2620
APAT20170	M20 x 170	32	20	125	114	30	200	K	22	200	150	300	2225	4934	1416	4672
APAT20200	M20 x 200	62	20	125	114	30	200	N	22	200	150	300	2225	4934	1416	4672

MTP-X

Homologado ETE Opt.1. Eje Cincado. Clip ATLANTIS C3-L

CÓDIGO	MXL	ESPEJOR MÁX. A FIJAR	Ø BROCA	PROFUNDIDAD MÍN. DE TALADRO	PROFUNDIDAD MÍN. DEL ANCLAJE	LLAVE DE INSTALACIÓN	PAR DE APRIETE (NM)	LETRA EJE	Ø ELEMENTO A FIJAR	MÍN. ESPEJOR MATERIAL BASE	DISTANCIA MÍN. AL BORDE "A"	DISTANCIA MÍN. ENTRE EJES "B"	EXTRACCIÓN HORMIGÓN NO-FISURADO	CIZALLADURA HORMIGÓN NO-FISURADO	EXTRACCIÓN HORMIGÓN FISURADO	CIZALLADURA HORMIGÓN FISURADO
APX08050	M8 x 50	2	8	40	37	13	15	A	9	80	72	144	182	392	130	275
APX08075	M8 x 75	9	8	60	55	13	15	C	9	80	72	144	405	641	283	556
APX08080	M8 x 80	14	8	60	55	13	15	D	9	80	72	144	405	641	283	556
APX08095	M8 x 95	29	8	60	55	13	15	E	9	80	72	144	405	641	283	556
APX08115	M8 x 115	49	8	60	55	13	15	G	9	80	72	144	405	641	283	556
APX10090	M10 x 90	10	10	75	68	17	40	E	12	90	90	180	874	1014	534	1014
APX10105	M10 x 105	25	10	75	68	17	40	F	12	90	90	180	874	1014	534	1014
APX10115	M10 x 115	35	10	75	68	17	40	G	12	90	90	180	874	1014	534	1014
APX10135	M10 x 135	55	10	75	68	17	40	H	12	90	90	180	874	1014	534	1014
APX10165	M10 x 165	85	10	75	68	17	40	K	12	90	90	180	874	1014	534	1014
APX10185	M10 x 185	105	10	75	68	17	40	L	12	90	90	180	874	1014	534	1014
APX12080	M12 x 80	4	12	65	60	19	60	D	14	100	105	210	488	1474	348	1182
APX12100	M12 x 100	4	12	85	80	19	60	E	14	105	105	210	1359	1474	728	1474
APX12110	M12 x 110	14	12	85	80	19	60	F	14	105	105	210	1359	1474	728	1474
APX12120	M12 x 120	24	12	85	80	19	60	G	14	105	105	210	1359	1474	728	1474
APX12130	M12 x 130	34	12	85	80	19	60	H	14	105	105	210	1359	1474	728	1474
APX12150	M12 x 150	54	12	85	80	19	60	I	14	105	105	210	1359	1474	728	1474
APX12180	M12 x 180	84	12	85	80	19	60	L	14	105	105	210	1359	1474	728	1474
APX12200	M12 x 200	104	12	85	80	19	60	M	14	105	105	210	1359	1474	728	1474
APX12220	M12 x 220	124	12	85	80	19	60	O	14	105	105	210	1359	1474	728	1474
APX12255	M12 x 255	159	12	85	80	19	60	R	14	105	105	210	1359	1474	728	1474
APX16145	M16 x 145	28	16	105	97	24	100	I	18	130	128	255	1650	2744	1310	2620
APX16175	M16 x 175	58	16	105	97	24	100	K	18	130	128	255	1650	2744	1310	2620
APX16220	M16 x 220	103	16	105	97	24	100	O	18	130	128	255	1650	2744	1310	2620
APX16250	M16 x 250	133	16	105	97	24	100	Q	18	130	128	255	1650	2744	1310	2620
APX20170	M20 x 170	32	20	125	114	30	200	K	22	150	150	300	2388	4258	1672	3343
APX20200	M20 x 200	62	20	125	114	30	200	M	22	150	150	300	2388	4258	1672	3343

MTP-G

Homologado ETE Opt.1. Eje ATLANTIS C3-L. Clip Inoxidable A4

CÓDIGO	MXL	ESPEJOR MÁX. A FIJAR	Ø BROCA	PROFUNDIDAD MÍN. DE TALADRO	PROFUNDIDAD MÍN. DEL ANCLAJE	LLAVE DE INSTALACIÓN	PAR DE APRIETE (NM)	LETRA EJE	Ø ELEMENTO A FIJAR	MÍN. ESPEJOR MATERIAL BASE	DISTANCIA MÍN. AL BORDE "A"	DISTANCIA MÍN. ENTRE EJES "B"	EXTRACCIÓN HORMIGÓN NO-FISURADO	CIZALLADURA HORMIGÓN NO-FISURADO	EXTRACCIÓN HORMIGÓN FISURADO	CIZALLADURA HORMIGÓN FISURADO
APG06060	M6 x 60	10	6	50	46	10	7	B	7	100	60	120	243	352	-	-
APG06070	M6 x 70	20	6	50	46	10	7	C	7	100	60	120	243	352	-	-
APG06100	M6 x 100	50	6	50	46	10	7	E	7	100	60	120	243	352	-	-
APG08050	M8 x 50	2	8	40	37	13	15	A	9	100	72	144	182	392	130	275
APG08060	M8 x 60	12	8	40	37	13	15	B	9	100	72	144	182	392	130	275
APG08075	M8 x 75	9	8	60	55	13	15	C	9	100	72	144	405	641	243	556
APG08095	M8 x 95	29	8	60	55	13	15	E	9	100	72	144	405	641	243	556
APG08115	M8 x 115	49	8	60	55	13	15	G	9	100	72	144	405	641	243	556
APG10070	M10 x 70	5	10	60	53	17	40	C	12	100	90	180	325	1014	232	1009
APG10090	M10 x 90	10	10	75	68	17	40	E	12	120	90	180	874	1014	485	1014
APG10105	M10 x 105	25	10	75	68	17	40	F	12	120	90	180	874	1014	485	1014
APG10115	M10 x 115	35	10	75	68	17	40	G	12	120	90	180	874	1014	485	1014
APG10135	M10 x 135	55	10	75	68	17	40	H	12	120	90	180	874	1014	485	1014
APG10165	M10 x 165	85	10	75	68	17	40	K	12	120	90	180	874	1014	485	1014
APG10185	M10 x 185	105	10	75	68	17	40	L	12	120	90	180	874	1014	485	1014
APG12080	M12 x 80	4	12	65	60	19	60	D	14	100	105	210	585	1474	417	1182
APG12110	M12 x 110	14	12	85	80	19	60	F	14	140	105	210	1399	1474	777	1474

CÓDIGO	MXL	ESPESOR MÁX. A FIJAR	Ø BROCA	PROFUNDIDAD MÍN. DE TALADRO	PROFUNDIDAD MÍN. DEL ANCLAJE	LLAVE DE INSTALACIÓN	PAR DE APRIETE (NM)	LETRA EJE	Ø ELEMENTO A FIJAR	MÍN. ESPESOR MATERIAL BASE	DISTANCIA MÍN. AL BORDE "A"	DISTANCIA MÍN. ENTRE EJES "B"	EXTRACCIÓN HORMIGÓN NO-FISURADO	CIZALLADURA HORMIGÓN NO-FISURADO	EXTRACCIÓN HORMIGÓN FISURADO	CIZALLADURA HORMIGÓN FISURADO
APG12130	M12 x 130	34	12	85	80	19	60	H	14	140	105	210	1399	1474	777	1474
APG12150	M12 x 150	54	12	85	80	19	60	I	14	140	105	210	1399	1474	777	1474
APG12180	M12 x 180	84	12	85	80	19	60	L	14	140	105	210	1399	1474	777	1474
APG12200	M12 x 200	104	12	85	80	19	60	M	14	140	105	210	1399	1474	777	1474
APG16125	M16 x 125	8	16	105	97	24	100	G	18	170	128	255	1747	2744	1310	2620
APG16145	M16 x 145	28	16	105	97	24	100	I	18	170	128	255	1747	2744	1310	2620
APG16175	M16 x 175	58	16	105	97	24	100	K	18	170	128	255	1747	2744	1310	2620
APG16220	M16 x 220	103	16	105	97	24	100	O	18	170	128	255	1747	2744	1310	2620
APG20170	M20 x 170	32	20	125	114	30	200	K	22	200	150	300	2388	4258	1456	3343
APG20200	M20 x 200	62	20	125	114	30	200	M	22	200	150	300	2388	4258	1456	3343

MTH

Anclaje macho para cargas altas en hormigón no fisurado

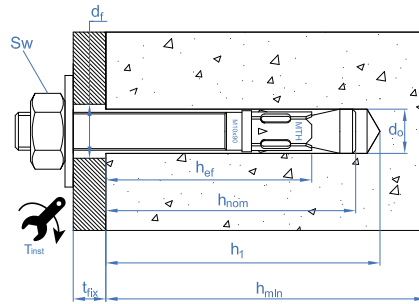

MTH

Homologado ETE Opt.7. Eje cincado. Clip cincado

CÓDIGO	MXL	ESPESOR MÁX. A FIJAR	Ø BROCA	PROFUNDIDAD MÍN. DE TALADRO	PROFUNDIDAD MÍN. DEL ANCLAJE	LLAVE DE INSTALACIÓN	PAR DE APRIETE (NM)	LETRA EJE	Ø ELEMENTO A FIJAR	MÍN. ESPESOR MATERIAL BASE	DISTANCIA MÍN. AL BORDE "A"	DISTANCIA MÍN. ENTRE EJES "B"	EXTRACCIÓN HORMIGÓN NO-FISURADO	CIZALLADURA HORMIGÓN NO-FISURADO
AH06060	M6 x 60	2	6	55	50	10	7	B	7	100	60	120	385	297
AH06070	M6 x 70	12	6	55	50	10	7	C	7	100	60	120	385	297
AH06080	M6 x 80	22	6	55	50	10	7	D	7	100	60	120	385	297
AH06090	M6 x 90	32	6	55	50	10	7	E	7	100	60	120	385	297
AH06100	M6 x 100	42	6	55	50	10	7	E	7	100	60	120	385	297
AH06110	M6 x 110	52	6	55	50	10	7	F	7	100	60	120	385	297
AH06120	M6 x 120	62	6	55	50	10	7	G	7	100	60	120	385	297
AH06130	M6 x 130	72	6	55	50	10	7	H	7	100	60	120	385	297
AH06140	M6 x 140	82	6	55	50	10	7	I	7	100	60	120	385	297
AH06150	M6 x 150	92	6	55	50	10	7	I	7	100	60	120	385	297
AH06160	M6 x 160	102	6	55	50	10	7	J	7	100	60	120	385	297
AH06170	M6 x 170	112	6	55	50	10	7	K	7	100	60	120	385	297
AH06180	M6 x 180	122	6	55	50	10	7	L	7	100	60	120	385	297
AH08060	M8 x 60	3	8	50	50	13	20	B	9	100	53	105	485	494
AH08075	M8 x 75	5	8	65	60	13	20	C	9	100	72	144	676	542
AH08090	M8 x 90	20	8	65	60	13	20	E	9	100	72	144	676	542
AH08100	M8 x 100	30	8	65	60	13	20	E	9	100	72	144	676	542
AH08115	M8 x 115	45	8	65	60	13	20	G	9	100	72	144	676	542
AH08120	M8 x 120	50	8	65	60	13	20	G	9	100	72	144	676	542
AH08130	M8 x 130	60	8	65	60	13	20	H	9	100	72	144	676	542
AH08155	M8 x 155	85	8	65	60	13	20	J	9	100	72	144	676	542
AH10070	M10 x 70	3	10	60	54	17	35	C	12	100	63	126	650	650
AH10080	M10 x 80	13	10	60	54	17	35	D	12	100	63	126	650	650
AH10090	M10 x 90	10	10	75	67	17	35	E	12	110	83	165	922	856
AH10100	M10 x 100	20	10	75	67	17	35	E	12	110	83	165	922	856
AH10120	M10 x 120	40	10	75	67	17	35	G	12	110	83	165	922	856
AH10140	M10 x 140	60	10	75	67	17	35	H	12	110	83	165	922	856
AH10150	M10 x 150	70	10	75	67	17	35	I	12	110	83	165	922	856
AH10160	M10 x 160	80	10	75	67	17	35	J	12	110	83	165	922	856
AH10170	M10 x 170	90	10	75	67	17	35	K	12	110	83	165	922	856
AH10210	M10 x 210	130	10	75	67	17	35	N	12	110	83	165	922	856
AH10230	M10 x 230	150	10	75	67	17	35	P	12	110	83	165	922	856
AH12090	M12 x 90	13	12	70	60	19	60	E	14	100	75	150	844	844
AH12100	M12 x 100	8	12	85	77	19	60	E	14	130	75	150	1251	1200
AH12110	M12 x 110	18	12	85	77	19	60	F	14	130	98	195	1251	1200
AH12120	M12 x 120	28	12	85	77	19	60	G	14	130	98	195	1251	1200
AH12130	M12 x 130	38	12	85	77	19	60	H	14	130	98	195	1251	1200
AH12140	M12 x 140	48	12	85	77	19	60	H	14	130	98	195	1251	1200
AH12160	M12 x 160	68	12	85	77	19	60	J	14	130	98	195	1251	1200
AH12180	M12 x 180	88	12	85	77	19	60	L	14	130	98	195	1251	1200
AH12200	M12 x 200	108	12	85	77	19	60	M	14	130	98	195	1251	1200
AH12220	M12 x 220	128	12	85	77	19	60	O	14	130	98	195	1251	1200
AH12250	M12 x 250	158	12	85	77	19	60	Q	14	130	98	195	1251	1200
AH14120	M14 x 120	12	14	100	91	22	90	G	16	150	113	225	1551	1637
AH14145	M14 x 145	37	14	100	91	22	90	I	16	150	113	225	1551	1637
AH14170	M14 x 170	62	14	100	91	22	90	K	16	150	113	225	1551	1637

CÓDIGO	MXL	ESPESOR MÁX. A FIJAR	Ø BROCA	PROFUNDIDAD MÍN. DE TALADRO	PROFUNDIDAD MÍN. DEL ANCLAJE	LLAVE DE INSTALACIÓN	PAR DE APRIETE (NM)	LETRA EJE	Ø ELEMENTO A FIJAR	MÍN. ESPESOR MATERIAL BASE	DISTANCIA MÍN. AL BORDE "A"	DISTANCIA MÍN. ENTRE EJES "B"	EXTRACCIÓN HORMIGÓN NO-FISURADO	CIZALLADURA HORMIGÓN NO-FISURADO
AH14220	M14 x 220	112	14	100	91	22	90	O	16	150	113	225	1551	1637
AH14250	M14 x 250	142	14	100	91	22	90	Q	16	150	113	225	1551	1637
AH16125	M16 x 125	3	16	110	104	24	120	G	18	168	126	252	1887	2237
AH16145	M16 x 145	23	16	110	104	24	120	I	18	168	126	252	1887	2237
AH16170	M16 x 170	48	16	110	104	24	120	K	18	168	126	252	1887	2237
AH16220	M16 x 220	98	16	110	104	24	120	O	18	168	126	252	1887	2237
AH16250	M16 x 250	128	16	110	104	24	120	Q	18	168	126	252	1887	2237
AH16280	M16 x 280	158	16	110	104	24	120	S	18	168	126	252	1887	2237
AH20170	M20 x 170	23	20	135	125	30	240	K	22	206	155	309	2496	3279
AH20220	M20 x 220	73	20	135	125	30	240	O	22	206	155	309	2496	3279
AH20270	M20 x 270	123	20	135	125	30	240	S	22	206	155	309	2496	3279

MTH-AT Homologado ETE Opt.7. Eje ATLANTIS C4-M. Clip ATLANTIS C4-M

CÓDIGO	MXL	ESPESOR MÁX. A FIJAR	Ø BROCA	PROFUNDIDAD MÍN. DE TALADRO	PROFUNDIDAD MÍN. DEL ANCLAJE	LLAVE DE INSTALACIÓN	PAR DE APRIETE (NM)	LETRA EJE	Ø ELEMENTO A FIJAR	MÍN. ESPESOR MATERIAL BASE	DISTANCIA MÍN. AL BORDE "A"	DISTANCIA MÍN. ENTRE EJES "B"	EXTRACCIÓN HORMIGÓN NO-FISURADO	CIZALLADURA HORMIGÓN NO-FISURADO
AHAT06060	M6 x 60	2	6	55	50	10	7	B	7	100	60	120	385	297
AHAT06080	M6 x 80	22	6	55	50	10	7	D	7	100	60	120	385	297
AHAT06100	M6 x 100	42	6	55	50	10	7	E	7	100	60	120	385	297
AHAT08060	M8 x 60	3	8	50	50	13	20	B	9	100	53	105	485	494
AHAT08075	M8 x 75	5	8	65	60	13	20	C	9	100	72	144	676	542
AHAT08090	M8 x 90	20	8	65	60	13	20	E	9	100	72	144	676	542
AHAT08115	M8 x 115	45	8	65	60	13	20	G	9	100	72	144	676	542
AHAT08130	M8 x 130	60	8	65	60	13	20	H	9	100	72	144	676	542
AHAT08155	M8 x 155	85	8	65	60	13	20	J	9	100	72	144	676	542
AHAT10070	M10 x 70	3	10	60	54	17	35	C	12	100	63	126	650	650
AHAT10080	M10 x 80	13	10	60	54	17	35	D	12	100	63	126	650	650
AHAT10090	M10 x 90	10	10	75	67	17	35	E	12	110	83	165	922	856
AHAT10100	M10 x 100	20	10	75	67	17	35	E	12	110	83	165	922	856
AHAT10120	M10 x 120	40	10	75	67	17	35	G	12	110	83	165	922	856
AHAT10140	M10 x 140	60	10	75	67	17	35	H	12	110	83	165	922	856
AHAT10150	M10 x 150	70	10	75	67	17	35	I	12	110	83	165	922	856
AHAT10160	M10 x 160	80	10	75	67	17	35	J	12	110	83	165	922	856
AHAT10170	M10 x 170	90	10	75	67	17	35	K	12	110	83	165	922	856
AHAT10210	M10 x 210	130	10	75	67	17	35	N	12	110	83	165	922	856
AHAT12090	M12 x 90	13	12	70	60	19	60	E	14	100	75	150	844	844
AHAT12100	M12 x 100	8	12	85	77	19	60	E	14	130	75	150	1251	1200
AHAT12110	M12 x 110	18	12	85	77	19	60	F	14	130	98	195	1251	1200
AHAT12130	M12 x 130	38	12	85	77	19	60	H	14	130	98	195	1251	1200
AHAT12140	M12 x 140	48	12	85	77	19	60	H	14	130	98	195	1251	1200
AHAT12160	M12 x 160	68	12	85	77	19	60	J	14	130	98	195	1251	1200
AHAT12180	M12 x 180	88	12	85	77	19	60	L	14	130	98	195	1251	1200
AHAT12200	M12 x 200	108	12	85	77	19	60	M	14	130	98	195	1251	1200
AHAT12220	M12 x 220	128	12	85	77	19	60	O	14	130	98	195	1251	1200
AHAT12250	M12 x 250	158	12	85	77	19	60	Q	14	130	98	195	1251	1200
AHAT16125	M16 x 125	3	16	110	104	24	120	G	18	168	126	252	1887	2237
AHAT16145	M16 x 145	23	16	110	104	24	120	I	18	168	126	252	1887	2237
AHAT16170	M16 x 170	48	16	110	104	24	120	K	18	168	126	252	1887	2237
AHAT16220	M16 x 220	98	16	110	104	24	120	O	18	168	126	252	1887	2237
AHAT16250	M16 x 250	128	16	110	104	24	120	Q	18	168	126	252	1887	2237
AHAT16280	M16 x 280	158	16	110	104	24	120	S	18	168	126	252	1887	2237
AHAT20170	M20 x 170	23	20	135	125	30	240	K	22	206	155	309	2496	3279
AHAT20220	M20 x 220	73	20	135	125	30	240	O	22	206	155	309	2496	3279
AHAT20270	M20 x 270	123	20	135	125	30	240	S	22	206	155	309	2496	3279

MTH-A4 Homologado ETE Opt.7. Eje Inoxidable A4. Clip Inoxidable A4

CÓDIGO	MXL	ESPESOR MÁX. A FIJAR	Ø BROCA	PROFUNDIDAD MÍN. DE TALADRO	PROFUNDIDAD MÍN. DEL ANCLAJE	LLAVE DE INSTALACIÓN	PAR DE APRIETE (NM)	LETRA EJE	Ø ELEMENTO A FIJAR	MÍN. ESPESOR MATERIAL BASE	DISTANCIA MÍN. AL BORDE "A"	DISTANCIA MÍN. ENTRE EJES "B"	EXTRACCIÓN HORMIGÓN NO-FISURADO	CIZALLADURA HORMIGÓN NO-FISURADO
MIA406045	M6 x 45	1	6	40	35	10	7	A	7	100	40	75	298	287
MIA406060	M6 x 60	2	6	55	50	10	7	B	7	100	60	120	438	287
MIA406080	M6 x 80	22	6	55	50	10	7	D	7	100	60	120	438	287
MIA408050	M8 x 50	4	8	40	35	13	20	A	9	100	40	75	219	263
MIA408075	M8 x 75	5	8	65	60	13	20	C	9	100	72	144	582	522
MIA408090	M8 x 90	20	8	65	60	13	20	E	9	100	72	144	582	522
MIA408115	M8 x 115	45	8	65	60	13	20	G	9	100	72	144	582	522
MIA410070	M10 x 70	3	10	60	54	17	35	C	12	100	60	120	485	650
MIA410090	M10 x 90	10	10	75	67	17	35	E	12	110	83	165	647	834
MIA410120	M10 x 120	40	10	75	67	17	35	G	12	110	83	165	647	834
MIA410150	M10 x 150	70	10	75	67	17	35	I	12	110	83	165	647	834
MIA412075	M12 x 75	5	12	60	55	19	60	C	14	100	65	130	561	673
MIA412090	M12 x 90	13	12	70	62	19	60	D	14	100	75	90	647	844
MIA412110	M12 x 110	18	12	85	77	19	60	F	14	130	98	195	1011	1207
MIA412140	M12 x 140	48	12	85	77	19	60	I	14	130	98	195	1011	1207
MIA416090	M16 x 90	4	16	75	69	24	120	D	18	100	75	150	683	819
MIA416145	M16 x 145	23	16	110	104	24	120	I	18	168	126	252	1416	2256
MIA416170	M16 x 170	48	16	110	104	24	120	K	18	168	126	252	1416	2256
MIA420120	M20 x 120	5	20	105	93	30	240	G	22	145	110	225	1190	2857
MIA420170	M20 x 170	23	20	135	125	30	240	K	22	206	155	309	2023	3521

MIA420220	M20 x 220	73	20	135	125	30	240	O	22	206	155	309	2023	3521
-----------	-----------	----	----	-----	-----	----	-----	---	----	-----	-----	-----	------	------

MTH-A2

Homologado ETE Opt.7. Eje Inoxidable A2. Clip Inoxidable A2

CÓDIGO	MXL	ESPESOR MÁX. A FIJAR	Ø BROCA	PROFUNDIDAD MÍN. DE TALADRO	PROFUNDIDAD MÍN. DEL ANCLAJE	LLAVE DE INSTALACIÓN	PAR DE APRIETE (NM)	LETRA EJE	Ø ELEMENTO A FIJAR	MÍN. ESPESOR MATERIAL BASE	DISTANCIA MÍN. AL BORDE "A"	DISTANCIA MÍN. ENTRE EJES "B"	EXTRACCIÓN HORMIGÓN NO-FISURADO	CIZALLADURA HORMIGÓN NO-FISURADO
MI06045	M6 x 45	1	6	40	35	10	7	A	7	100	40	75	298	287
MI06060	M6 x 60	2	6	55	50	10	7	B	7	100	60	120	438	287
MI06080	M6 x 80	22	6	55	50	10	7	D	7	100	60	120	438	287
MI06120	M6 x 120	62	6	55	50	10	7	G	7	100	60	120	438	287
MI06140	M6 x 140	82	6	55	50	10	7	I	7	100	60	120	438	287
MI06160	M6 x 160	102	6	55	50	10	7	J	7	100	60	120	438	287
MI06170	M6 x 170	112	6	55	50	10	7	K	7	100	60	120	438	287
MI06180	M6 x 180	122	6	55	50	10	7	L	7	100	60	120	438	287
MI08050	M8 x 50	4	8	40	35	13	20	A	9	100	40	75	219	263
MI08075	M8 x 75	5	8	65	60	13	20	C	9	100	72	144	582	522
MI08090	M8 x 90	20	8	65	60	13	20	E	9	100	72	144	582	522
MI08115	M8 x 115	45	8	65	60	13	20	G	9	100	72	144	582	522
MI10070	M10 x 70	3	10	60	54	17	35	C	12	100	60	120	485	650
MI10090	M10 x 90	10	10	75	67	17	35	E	12	110	83	165	647	834
MI10120	M10 x 120	40	10	75	67	17	35	G	12	110	83	165	647	834
MI10150	M10 x 150	70	10	75	67	17	35	I	12	110	83	165	647	834
MI12075	M12 x 75	5	12	60	55	19	60	C	14	100	65	130	561	672
MI12090	M12 x 90	13	12	70	62	19	60	D	14	120	75	150	647	844
MI12110	M12 x 110	18	12	85	77	19	60	F	14	130	98	195	1011	1207
MI12140	M12 x 140	48	12	85	77	19	60	I	14	130	98	195	1011	1207
MI16090	M16 x 90	4	16	75	69	24	120	D	18	100	75	150	683	819
MI16145	M16 x 145	23	16	110	104	24	120	I	18	168	126	252	1416	2256
MI16170	M16 x 170	48	16	110	104	24	120	K	18	168	126	252	1416	2256
MI20120	M20 x 120	5	20	105	93	30	240	G	22	145	110	225	1190	2857
MI20170	M20 x 170	23	20	135	125	30	240	K	22	206	155	309	2023	3521
MI20220	M20 x 220	73	20	135	125	30	240	O	22	206	155	309	2023	3521

MTA

Anclaje macho para cargas altas

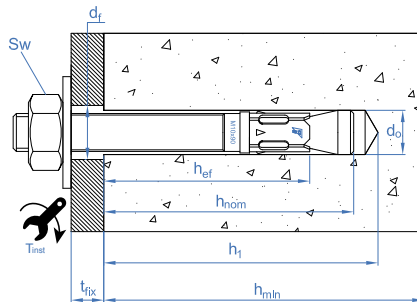

MTA

Eje cincado. Clip cincado

CÓDIGO	MXL	ESPESOR MÁX. A FIJAR	Ø BROCA	PROFUNDIDAD MÍN. DE TALADRO	PROFUNDIDAD MÍN. DEL ANCLAJE	LLAVE DE INSTALACIÓN	PAR DE APRIETE (NM)	Ø ELEMENTO A FIJAR	MÍN. ESPESOR MATERIAL BASE	DISTANCIA MÍN. AL BORDE "A"	DISTANCIA MÍN. ENTRE EJES "B"	EXTRACCIÓN HORMIGÓN NO-FISURADO	CIZALLADURA HORMIGÓN NO-FISURADO
AM06045	M6 x 45	1	6	40	35	10	7	7	100	40	75	298	297
AM06055	M6 x 55	11	6	40	35	10	7	7	100	40	75	298	297
AM06060	M6 x 60	2	6	55	50	10	7	7	100	60	120	385	297
AM06065	M6 x 65	7	6	55	50	10	7	7	100	60	120	385	297
AM06070	M6 x 70	12	6	55	50	10	7	7	100	60	120	385	297
AM06080	M6 x 80	22	6	55	50	10	7	7	100	60	120	385	297
AM06085	M6 x 85	27	6	55	50	10	7	7	100	60	120	385	297
AM06090	M6 x 90	32	6	55	50	10	7	7	100	60	120	385	297
AM06100	M6 x 100	42	6	55	50	10	7	7	100	60	120	385	297
AM06110	M6 x 110	52	6	55	50	10	7	7	100	60	120	385	297
AM06120	M6 x 120	62	6	55	50	10	7	7	100	60	120	385	297
AM06130	M6 x 130	72	6	55	50	10	7	7	100	60	120	385	297
AM06140	M6 x 140	82	6	55	50	10	7	7	100	60	120	385	297
AM06150	M6 x 150	92	6	55	50	10	7	7	100	60	120	385	297
AM06160	M6 x 160	102	6	55	50	10	7	7	100	60	120	385	297
AM06170	M6 x 170	112	6	55	50	10	7	7	100	60	120	385	297
AM06180	M6 x 180	122	6	55	50	10	7	7	100	60	120	385	297
AM08050	M8 x 50	4	8	40	35	13	20	9	100	40	75	263	263
AM08060	M8 x 60	3	8	50	47	13	20	9	100	53	105	485	494
AM08065	M8 x 65	8	8	50	47	13	20	9	100	53	105	485	494
AM08075	M8 x 75	5	8	65	60	13	20	9	100	72	144	676	542
AM08090	M8 x 90	20	8	65	60	13	20	9	100	72	144	676	542
AM08115	M8 x 115	45	8	65	60	13	20	9	100	72	144	676	542
AM08120	M8 x 120	50	8	65	60	13	20	9	100	72	144	676	542
AM08130	M8 x 130	60	8	65	60	13	20	9	100	72	144	676	542
AM08155	M8 x 155	85	8	65	60	13	20	9	100	72	144	676	542
AM10065	M10 x 65	1	10	55	52	17	35	12	100	60	120	604	604
AM10070	M10 x 70	3	10	60	54	17	35	12	100	63	125	650	650

CÓDIGO	MXL	ESPESOR MÁX. A FIJAR	Ø BROCA	PROFUNDIDAD MÍN. DE TALADRO	PROFUNDIDAD MÍN. DEL ANCLAJE	LLAVE DE INSTALACIÓN	PAR DE APRIETE (NM)	Ø ELEMENTO A FIJAR	MÍN. ESPESOR MATERIAL BASE	DISTANCIA MÍN. AL BORDE "A"	DISTANCIA MÍN. ENTRE EJES "B"	EXTRACCIÓN HORMIGÓN NO-FISURADO	CIZALLADURA HORMIGÓN NO-FISURADO
AM10080	M10 x 80	13	10	60	54	17	35	12	100	63	125	667	667
AM10090	M10 x 90	10	10	75	67	17	35	12	110	83	165	922	856
AM10100	M10 x 100	20	10	75	67	17	35	12	110	83	165	922	856
AM10120	M10 x 120	40	10	75	67	17	35	12	110	83	165	922	856
AM10140	M10 x 140	60	10	75	67	17	35	12	110	83	165	922	856
AM10150	M10 x 150	70	10	75	67	17	35	12	110	83	165	922	856
AM10160	M10 x 160	80	10	75	67	17	35	12	110	83	165	922	856
AM10170	M10 x 170	90	10	75	67	17	35	12	110	83	165	922	856
AM10210	M10 x 210	130	10	75	67	17	35	12	110	83	165	922	856
AM10230	M10 x 230	150	10	75	67	17	35	12	110	83	165	922	856
AM12075	M12 x 75	5	12	60	55	19	60	14	100	65	130	673	673
AM12080	M12 x 80	3	12	70	62	19	60	14	100	75	150	844	844
AM12090	M12 x 90	13	12	70	62	19	60	14	100	75	150	844	844
AM12100	M12 x 100	8	12	85	77	19	60	14	130	98	195	1251	1200
AM12110	M12 x 110	18	12	85	77	19	60	14	130	98	195	1251	1200
AM12120	M12 x 120	28	12	85	77	19	60	14	130	98	195	1251	1200
AM12140	M12 x 140	48	12	85	77	19	60	14	130	98	195	1251	1200
AM12160	M12 x 160	68	12	85	77	19	60	14	130	98	195	1251	1200
AM12180	M12 x 180	88	12	85	77	19	60	14	130	98	195	1251	1200
AM12220	M12 x 220	128	12	85	77	19	60	14	130	98	195	1251	1200
AM12250	M12 x 250	158	12	85	77	19	60	14	130	98	195	1251	1200
AM14080	M14 x 80	5	14	65	59	22	90	16	100	65	130	650	650
AM14100	M14 x 100	5	14	85	69	22	90	16	125	95	190	1166	1637
AM14120	M14 x 120	12	14	100	91	22	90	16	150	113	225	1551	1637
AM14145	M14 x 145	37	14	100	91	22	90	16	150	113	225	1551	1637
AM14170	M14 x 170	62	14	100	91	22	90	16	150	113	225	1551	1637
AM14220	M14 x 220	112	14	100	91	22	90	16	150	113	225	1551	1637
AM14250	M14 x 250	142	14	100	91	22	90	16	150	113	225	1551	1637
AM16090	M16 x 90	4	16	75	69	24	120	18	100	75	150	819	819
AM16110	M16 x 110	7	16	75	69	24	120	18	100	75	150	1838	2237
AM16125	M16 x 125	3	16	110	104	24	120	18	168	126	252	1838	2237
AM16145	M16 x 145	23	16	110	104	24	120	18	168	126	252	1838	2237
AM16170	M16 x 170	48	16	110	104	24	120	18	168	126	252	1838	2237
AM16220	M16 x 220	98	16	110	104	24	120	18	168	126	252	1838	2237
AM16250	M16 x 250	128	16	110	104	24	120	18	168	126	252	1838	2237
AM16280	M16 x 280	158	16	110	104	24	120	18	168	126	252	1838	2237
AM20120	M20 x 120	5	20	105	93	30	240	22	145	110	225	1429	2857
AM20170	M20 x 170	23	20	135	125	30	240	22	206	155	309	2496	3279
AM20220	M20 x 220	73	20	135	125	30	240	22	206	155	309	2496	3279
AM20270	M20 x 270	123	20	135	125	30	240	22	206	155	309	2496	3279
AM24180	M24 x 180	10	24	155	143	36	250	26	250	200	400	2023	4934
AM24260	M24 x 260	80	24	155	143	36	250	26	250	200	400	2023	4934

TH/TF/TX Anclaje de fijación directa en hormigón

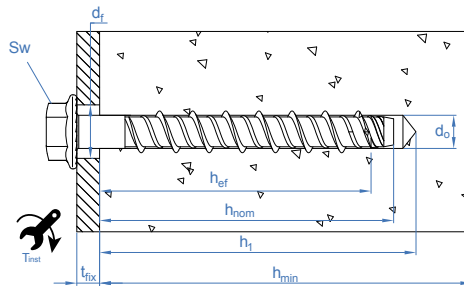

THE Homologado ETE Opt.1. Cabeza hexagonal con recubrimiento ATLANTIS C3-H

CÓDIGO	MXL	LONGITUD	Ø BROCA	PROFUNDIDAD MÍN. DE TALADRO	MÍN. ESPESOR MATERIAL BASE	Ø ELEMENTO A FIJAR	PROFUNDIDAD MÍN. DEL ANCLAJE	ESPESOR MÁX. A FIJAR	PAR DE APRIETE (NM)	DISTANCIA MÍN. AL BORDE "A"	DISTANCIA MÍN. ENTRE EJES "B"	LLAVE DE INSTALACIÓN	EXTRACCIÓN HORMIGÓN NO-FISURADO	CIZALLADURA HORMIGÓN NO-FISURADO	EXTRACCIÓN HORMIGÓN FISURADO	CIZALLADURA HORMIGÓN FISURADO
THE05040	Ø5 x 40	40	5	45	80	8	35	5	8	40	80	8	326	326	228	228
THE05050	Ø5 x 50	50	5	55	80	8	45	5	8	53	105	8	494	398	346	346
THE05060	Ø5 x 60	60	5	55	80	8	45	15	8	53	105	8	494	398	346	346
THE05080	Ø5 x 80	80	5	55	80	8	45	35	8	53	105	8	494	398	346	346
THE05100	Ø5 x 100	100	5	55	80	8	45	55	8	53	105	8	494	398	346	346
THE06040	Ø6 x 40	40	6	45	100	9	35	5	10	39	78	10	202	608	185	454
THE06050	Ø6 x 50	50	6	45	100	9	35	15	10	39	78	10	202	608	185	454
THE06060	Ø6 x 60	60	6	65	100	9	55	5	10	65	129	10	673	608	471	542
THE06070	Ø6 x 70	70	6	65	100	9	55	15	10	65	129	10	673	608	471	542
THE06080	Ø6 x 80	80	6	65	100	9	55	25	10	65	129	10	673	608	471	542
THE06100	Ø6 x 100	100	6	65	100	9	55	45	10	65	129	10	673	608	471	542
THE06120	Ø6 x 120	120	6	65	100	9	55	65	10	65	129	10	673	608	471	542
THE08055	Ø8 x 55	55	8	60	100	12	50	5	20	57	113	13	457	950	320	691
THE08060	Ø8 x 60	60	8	60	100	12	50	10	20	57	113	13	457	950	320	691
THE08070	Ø8 x 70	70	8	75	100	12	65	5	20	76	152	13	857	950	600	762

CÓDIGO	MXL	LONGITUD	Ø BROCA	PROFUNDIDAD MÍN. DE TALADRO	MÍN. ESPESOR MATERIAL BASE	Ø ELEMENTO A FIJAR	PROFUNDIDAD MÍN. DEL ANCLAJE	ESPEOR MÁX. A FIJAR	PAR DE APRIETE (NM)	DISTANCIA MÍN. AL BORDE "A"	DISTANCIA MÍN. ENTRE EJES "B"	LLAVE DE INSTALACIÓN	EXTRACCIÓN HORMIGÓN NO-FISURADO	CIZALLADURA HORMIGÓN NO-FISURADO	EXTRACCIÓN HORMIGÓN FISURADO	CIZALLADURA HORMIGÓN FISURADO
THE08080	Ø8 x 80	80	8	75	100	12	65	15	20	76	152	13	857	950	600	762
THE08090	Ø8 x 90	90	8	75	100	12	65	25	20	76	152	13	857	950	600	762
THE08100	Ø8 x 100	100	8	75	100	12	65	35	20	76	152	13	857	950	600	762
THE08110	Ø8 x 110	110	8	75	100	12	65	45	20	76	152	13	857	950	600	762
THE08120	Ø8 x 120	120	8	75	100	12	65	55	20	76	152	13	857	950	600	762
THE08140	Ø8 x 140	140	8	75	100	12	65	75	20	76	152	13	857	950	600	762
THE10060	Ø10 x 60	60	10	65	100	14	55	5	30	63	125	15	638	1245	447	871
THE10070	Ø10 x 70	70	10	65	100	14	55	15	30	63	125	15	638	1245	447	871
THE10080	Ø10 x 80	80	10	65	100	14	55	25	30	63	125	15	638	1245	447	871
THE10090	Ø10 x 90	90	10	95	135	14	85	5	30	101	201	15	1310	1330	917	1330
THE10100	Ø10 x 100	100	10	95	135	14	85	15	30	101	201	15	1310	1330	917	1330
THE10120	Ø10 x 120	120	10	95	135	14	85	35	30	101	201	15	1310	1330	917	1330
THE10140	Ø10 x 140	140	10	95	135	14	85	55	30	101	201	15	1310	1330	917	1330
THE12080	Ø12 x 80	80	12	90	120	16	75	5	50	87	174	18	1055	1808	738	1720
THE12090	Ø12 x 90	90	12	90	120	16	75	15	50	87	174	18	1055	1808	738	1720
THE12110	Ø12 x 110	110	12	120	170	16	105	5	50	126	251	18	1822	1808	1275	1808
THE12130	Ø12 x 130	130	12	120	170	16	105	25	50	126	251	18	1822	1808	1275	1808
THE12150	Ø12 x 150	150	12	120	170	16	105	45	50	126	251	18	1822	1808	1275	1808
THE14080	Ø14 x 80	80	14	90	120	18	75	5	70	87	174	21	1055	2559	738	1883
THE14100	Ø14 x 100	100	14	90	120	18	75	25	70	87	174	21	1055	2559	738	1883
THE14120	Ø14 x 120	120	14	130	185	18	115	5	70	138	276	21	2107	2559	1475	2559
THE14130	Ø14 x 130	130	14	130	185	18	115	15	70	138	276	21	2107	2559	1475	2559
THE14140	Ø14 x 140	140	14	130	185	18	115	25	70	138	276	21	2107	2559	1475	2559
THE14160	Ø14 x 160	160	14	130	185	18	115	45	70	138	276	21	2107	2559	1475	2559
THE16100	Ø16 x 100	100	16	100	115	20	80	20	80	87	174	24	1055	2257	738	1580
THE16150	Ø16 x 150	150	16	140	185	20	120	30	80	138	276	24	2107	2814	1475	2814
THE18100	Ø18 x 100	100	18	110	140	22	90	10	90	105	209	24	1384	3680	968	2576
THE18130	Ø18 x 130	130	18	110	140	22	90	40	90	105	209	24	1384	3680	968	2576
THE18160	Ø18 x 160	160	18	160	225	22	140	20	90	168	336	24	2830	3921	1981	3921
THE18180	Ø18 x 180	180	18	160	225	22	140	40	90	168	336	24	2830	3921	1981	3921
THE18200	Ø18 x 200	200	18	160	225	22	140	60	90	168	336	24	2830	3921	1981	3921

THA

Homologado ETE Opt.1. Cabeza avellanada con recubrimiento ATLANTIS C3-H

CÓDIGO	MXL	LONGITUD	Ø BROCA	PROFUNDIDAD MÍN. DE TALADRO	MÍN. ESPESOR MATERIAL BASE	Ø ELEMENTO A FIJAR	PROFUNDIDAD MÍN. DEL ANCLAJE	ESPEOR MÁX. A FIJAR	PAR DE APRIETE (NM)	DISTANCIA MÍN. AL BORDE "A"	DISTANCIA MÍN. ENTRE EJES "B"	LLAVE DE INSTALACIÓN	EXTRACCIÓN HORMIGÓN NO-FISURADO	CIZALLADURA HORMIGÓN NO-FISURADO	EXTRACCIÓN HORMIGÓN FISURADO	CIZALLADURA HORMIGÓN FISURADO
THA05040	Ø5 x 40	40	5	45	80	8	35	5	8	40	80	TX25	326	326	228	228
THA05060	Ø5 x 60	60	5	55	80	8	45	15	8	53	105	TX25	494	398	346	346
THA05080	Ø5 x 80	80	5	55	80	8	45	35	8	53	105	TX25	494	398	346	346
THA05100	Ø5 x 100	100	5	55	80	8	45	55	8	53	105	TX25	494	398	346	346
THA06045	Ø6 x 45	45	6	45	100	9	35	10	10	39	78	TX30	202	608	185	454
THA06050	Ø6 x 50	50	6	45	100	9	35	15	10	39	78	TX30	202	608	185	454
THA06060	Ø6 x 60	60	6	65	100	9	55	5	10	65	129	TX30	673	608	471	542
THA06080	Ø6 x 80	80	6	65	100	9	55	25	10	65	129	TX30	673	608	471	542
THA06100	Ø6 x 100	100	6	65	100	9	55	45	10	65	129	TX30	673	608	471	542
THA06120	Ø6 x 120	120	6	65	100	9	55	65	10	65	129	TX30	673	608	471	542
THA06140	Ø6 x 140	140	6	65	100	9	55	85	10	65	129	TX30	673	608	471	542
THA08060	Ø8 x 60	60	8	60	100	12	50	10	20	57	113	TX45	457	950	320	691
THA08080	Ø8 x 80	80	8	75	100	12	65	15	20	76	152	TX45	857	950	600	762
THA08100	Ø8 x 100	100	8	75	100	12	65	35	20	76	152	TX45	857	950	600	762
THA08120	Ø8 x 120	120	8	75	100	12	65	55	20	76	152	TX45	857	950	600	762
THA10100	Ø10 x 100	100	10	95	135	14	85	15	30	101	201	TX50	1310	1330	600	762
THA10120	Ø10 x 120	120	10	95	135	14	85	35	30	101	201	TX50	1310	1330	600	762

THP

Homologado ETE Opt.1. Cabeza alomada con recubrimiento ATLANTIS C3-H

CÓDIGO	MXL	LONGITUD	Ø BROCA	PROFUNDIDAD MÍN. DE TALADRO	MÍN. ESPESOR MATERIAL BASE	Ø ELEMENTO A FIJAR	PROFUNDIDAD MÍN. DEL ANCLAJE	ESPEOR MÁX. A FIJAR	PAR DE APRIETE (NM)	DISTANCIA MÍN. AL BORDE "A"	DISTANCIA MÍN. ENTRE EJES "B"	LLAVE DE INSTALACIÓN	EXTRACCIÓN HORMIGÓN NO-FISURADO	CIZALLADURA HORMIGÓN NO-FISURADO	EXTRACCIÓN HORMIGÓN FISURADO	CIZALLADURA HORMIGÓN FISURADO
THP05040	Ø5 x 40	40	5	45	80	8	35	5	8	40	80	TX30	326	326	228	228
THP05060	Ø5 x 60	60	5	55	80	8	45	15	8	53	105	TX30	494	398	346	346
THP06040	Ø6 x 40	40	6	45	100	9	35	5	10	39	78	TX40	202	608	185	454
THP06050	Ø6 x 50	50	6	45	100	9	35	15	10	39	78	TX40	202	608	185	454
THP06060	Ø6 x 60	60	6	65	100	9	55	5	10	65	129	TX40	673	608	471	542
THP06080	Ø6 x 80	80	6	65	100	9	55	25	10	65	129	TX40	673	608	471	542
THP06100	Ø6 x 100	100	6	65	100	9	55	45	10	65	129	TX40	673	608	471	542
THP08060	Ø8 x 60	60	8	60	100	12	50	10	20	57	113	TX45	457	950	320	691
THP08080	Ø8 x 80	80	8	75	100	12	65	15	20	76	152	TX45	857	950	600	762

THT

Homologado ETE Opt.1. Cabeza Truss con recubrimiento ATLANTIS C3-H

CÓDIGO	MXL	LONGITUD	Ø BROCA	PROFUNDIDAD MÍN. DE TALADRO	MÍN. ESPESOR MATERIAL BASE	Ø ELEMENTO A FIJAR	PROFUNDIDAD MÍN. DEL ANCLAJE	ESPEOR MÁX. A FIJAR	PAR DE APRIETE (NM)	DISTANCIA MÍN. AL BORDE "A"	DISTANCIA MÍN. ENTRE EJES "B"	LLAVE DE INSTALACIÓN	EXTRACCIÓN HORMIGÓN NO-FISURADO	CIZALLADURA HORMIGÓN NO-FISURADO	EXTRACCIÓN HORMIGÓN FISURADO	CIZALLADURA HORMIGÓN FISURADO
THT06040	Ø6 x 40	40	6	45	100	9	35	5	10	39	78	TX30	202	608	185	454
THT06050	Ø6 x 50	50	6	45	100	9	35	15	10	39	78	TX30	202	608	185	454
THT06060	Ø6 x 60	60	6	65	100	9	55	5	10	65	129	TX30	673	608	471	542

TFE																
Homologado ETE Opt.1. Cabeza hexagonal con recubrimiento cincado																
CÓDIGO	MXL	LONGITUD	Ø BROCA	PROFUNDIDAD MÍN. DE TALADRO	MÍN. ESPESOR MATERIAL BASE	Ø ELEMENTO A FIJAR	PROFUNDIDAD MÍN. DEL ANCLAJE	ESPEOR MÁX. A FIJAR	PAR DE APRIETE (NM)	DISTANCIA MÍN. AL BORDE "A"	DISTANCIA MÍN. ENTRE EJES "B"	LLAVE DE INSTALACIÓN	EXTRACCIÓN HORMIGÓN NO-FISURADO	CIZALLADURA HORMIGÓN NO-FISURADO	EXTRACCIÓN HORMIGÓN FISURADO	CIZALLADURA HORMIGÓN FISURADO
TFE05040	Ø5 x 40	40	5	45	80	8	35	5	8	40	80	8	326	326	228	228
TFE05050	Ø5 x 50	50	5	55	80	8	45	5	8	53	105	8	494	398	346	346
TFE05060	Ø5 x 60	60	5	55	80	8	45	15	8	53	105	8	494	398	346	346
TFE05080	Ø5 x 80	80	5	55	80	8	45	35	8	53	105	8	494	398	346	346
TFE05100	Ø5 x 100	100	5	55	80	8	45	55	8	53	105	8	494	398	346	346
TFE06040	Ø6 x 40	40	6	45	100	9	35	5	10	39	78	10	202	608	185	454
TFE06050	Ø6 x 50	50	6	45	100	9	35	15	10	39	78	10	202	608	185	454
TFE06060	Ø6 x 60	60	6	65	100	9	55	5	10	65	129	10	673	608	471	542
TFE06070	Ø6 x 70	70	6	65	100	9	55	15	10	65	129	10	673	608	471	542
TFE06080	Ø6 x 80	80	6	65	100	9	55	25	10	65	129	10	673	608	471	542
TFE06100	Ø6 x 100	100	6	65	100	9	55	45	10	65	129	10	673	608	471	542
TFE06120	Ø6 x 120	120	6	65	100	9	55	65	10	65	129	10	673	608	471	542
TFE08055	Ø8 x 55	55	8	60	100	12	50	5	20	57	113	13	457	950	320	691
TFE08060	Ø8 x 60	60	8	60	100	12	50	10	20	57	113	13	457	950	320	691
TFE08070	Ø8 x 70	70	8	75	100	12	65	5	20	76	152	13	857	950	600	762
TFE08080	Ø8 x 80	80	8	75	100	12	65	15	20	76	152	13	857	950	600	762
TFE08090	Ø8 x 90	90	8	75	100	12	65	25	20	76	152	13	857	950	600	762
TFE08100	Ø8 x 100	100	8	75	100	12	65	35	20	76	152	13	857	950	600	762
TFE08110	Ø8 x 110	110	8	75	100	12	65	45	20	76	152	13	857	950	600	762
TFE08120	Ø8 x 120	120	8	75	100	12	65	55	20	76	152	13	857	950	600	762
TFE08140	Ø8 x 140	140	8	75	100	12	65	75	20	76	152	13	857	950	600	762
TFE10060	Ø10 x 60	60	10	65	100	14	55	5	30	63	125	15	638	1245	447	871
TFE10070	Ø10 x 70	70	10	65	100	14	55	15	30	63	125	15	638	1245	447	871
TFE10080	Ø10 x 80	80	10	85	120	14	75	25	30	88	176	15	638	1245	447	871
TFE10090	Ø10 x 90	90	10	95	135	14	85	5	30	101	201	15	1310	1330	917	1330
TFE10100	Ø10 x 100	100	10	95	135	14	85	15	30	101	201	15	1310	1330	917	1330
TFE10120	Ø10 x 120	120	10	95	135	14	85	35	30	101	201	15	1310	1330	917	1330
TFE10140	Ø10 x 140	140	10	95	135	14	85	55	30	101	201	15	1310	1330	917	1330
TFE12080	Ø12 x 80	80	12	90	120	16	75	5	50	87	174	18	1055	1808	738	1720
TFE12090	Ø12 x 90	90	12	90	120	16	75	15	50	87	174	18	1055	1808	738	1720
TFE12110	Ø12 x 110	110	12	120	170	16	105	5	50	126	251	18	1822	1808	1275	1808
TFE12130	Ø12 x 130	130	12	120	170	16	105	25	50	126	251	18	1822	1808	1275	1808
TFE12150	Ø12 x 150	150	12	120	170	16	105	45	50	126	251	18	1822	1808	1275	1808
TFE14080	Ø14 x 80	80	14	90	120	18	75	5	70	87	174	21	1055	2559	738	1883
TFE14100	Ø14 x 100	100	14	90	120	18	75	25	70	87	174	21	1055	2559	738	1883
TFE14120	Ø14 x 120	120	14	130	185	18	115	5	70	138	276	21	2107	2559	1475	2559
TFE14130	Ø14 x 130	130	14	130	185	18	115	15	70	138	276	21	2107	2559	1475	2559
TFE14140	Ø14 x 140	140	14	130	185	18	115	25	70	138	276	21	2107	2559	1475	2559
TFE14160	Ø14 x 160	160	14	130	185	18	115	45	70	138	276	21	2107	2559	1475	2559
TFE16100	Ø16 x 100	100	16	100	115	20	80	20	80	87	174	24	1055	2257	738	1580
TFE16150	Ø16 x 150	150	16	140	185	20	120	30	80	138	276	24	2107	2814	1475	2814
TFE18100	Ø18 x 100	100	18	110	140	22	90	10	90	105	209	24	1384	3680	968	2576
TFE18130	Ø18 x 130	130	18	110	140	22	90	40	90	105	209	24	1384	3680	968	2576
TFE18160	Ø18 x 160	160	18	160	225	22	140	20	90	168	336	24	2830	3921	1981	3921
TFE18180	Ø18 x 180	180	18	160	225	22	140	40	90	168	336	24	2830	3921	1981	3921
TFE18200	Ø18 x 200	200	18	160	225	22	140	60	90	168	336	24	2830	3921	1981	3921

TFA																
Homologado ETE Opt.1. Cabeza avellanada con recubrimiento cincado																
CÓDIGO	MXL	LONGITUD	Ø BROCA	PROFUNDIDAD MÍN. DE TALADRO	MÍN. ESPESOR MATERIAL BASE	Ø ELEMENTO A FIJAR	PROFUNDIDAD MÍN. DEL ANCLAJE	ESPEOR MÁX. A FIJAR	PAR DE APRIETE (NM)	DISTANCIA MÍN. AL BORDE "A"	DISTANCIA MÍN. ENTRE EJES "B"	LLAVE DE INSTALACIÓN	EXTRACCIÓN HORMIGÓN NO-FISURADO	CIZALLADURA HORMIGÓN NO-FISURADO	EXTRACCIÓN HORMIGÓN FISURADO	CIZALLADURA HORMIGÓN FISURADO
TFA05040	Ø5 x 40	40	5	45	80	8	35	5	8	40	80	TX25	326	326	228	228
TFA05060	Ø5 x 60	60	5	55	80	8	45	15	8	53	105	TX25	494	398	346	346
TFA05080	Ø5 x 80	80	5	55	80	8	45	35	8	53	105	TX25	494	398	346	346
TFA05100	Ø5 x 100	100	5	55	80	8	45	55	8	53	105	TX25	494	398	346	346
TFA06045	Ø6 x 45	45	6	45	100	9	35	10	10	39	78	TX30	202	608	185	454
TFA06050	Ø6 x 50	50	6	45	100	9	35	15	10	39	78	TX30	202	608	185	454
TFA06060	Ø6 x 60	60	6	65	100	9	55	5	10	65	129	TX30	673	608	471	542
TFA06080	Ø6 x 80	80	6	65	100	9	55	25	10	65	129	TX30	673	608	471	542
TFA06100	Ø6 x 100	100	6	65	100	9	55	45	10	65	129	TX30	673	608	471	542
TFA06120	Ø6 x 120	120	6	65	100	9	55	65	10	65	129	TX30	673	608	471	542
TFA06140	Ø6 x 140	140	6	65	100	9	55	85	10	65	129	TX30	673	608	471	542
TFA08060	Ø8 x 60	60	8	60	100	12	50	10	20	57	113	TX45	457	950	320	691
TFA08080	Ø8 x 80	80	8	75	100	12	65	15	20	76	152	TX45	857	950	600	762
TFA08100	Ø8 x 100	100	8	75	100	12	65	35	20	76	152	TX45	857	950	600	762
TFA08120	Ø8 x 120	120	8	75	100	12	65	55	20	76	152	TX45	857	950	600	762
TFA10100	Ø10 x 100	100	10	95	135	14	85	15	30	101	201	TX50	1310	1330	917	1330
TFA10120	Ø10 x 120	120	10	95	135	14	85	35	30	101	201	TX50	1310	1330	917	1330

TFN																
Homologado ETE Opt.1. Cabeza hexagonal con recubrimiento cincado y sin arandela																
CÓDIGO	MXL	LONGITUD	Ø BROCA	PROFUNDIDAD MÍN. DE TALADRO	MÍN. ESPESOR MATERIAL BASE	Ø ELEMENTO A FIJAR	PROFUNDIDAD MÍN. DEL ANCLAJE	ESPEOR MÁX. A FIJAR	PAR DE APRIETE (NM)	DISTANCIA MÍN. AL BORDE "A"	DISTANCIA MÍN. ENTRE EJES "B"	LLAVE DE INSTALACIÓN	EXTRACCIÓN HORMIGÓN NO-FISURADO	CIZALLADURA HORMIGÓN NO-FISURADO	EXTRACCIÓN HORMIGÓN FISURADO	CIZALLADURA HORMIGÓN FISURADO
TFN14080	Ø14 x 80	80	14	90	120	18	75	5	70	87	174	24	1055	2559	738	1883

TFS

Homologado ETE Opt.1. Espárrago cincado

CÓDIGO	MXL	LONGITUD	Ø BROCA	PROFUNDIDAD MÍN. DE TALADRO	MÍN. ESPESOR MATERIAL BASE	Ø ELEMENTO A FIJAR	PROFUNDIDAD MÍN. DEL ANCLAJE	ESPEOR MÁX. A FIJAR	PAR DE APRIETE (NM)	DISTANCIA MÍN. AL BORDE "A"	DISTANCIA MÍN. ENTRE EJES "B"	LLAVE DE INSTALACIÓN	EXTRACCIÓN HORMIGÓN NO-FISURADO	CIZALLADURA HORMIGÓN NO-FISURADO	EXTRACCIÓN HORMIGÓN FISURADO	CIZALLADURA HORMIGÓN FISURADO
TFS06100	Ø6 x 100	100	6	65	100	9	55	31	10	65	129	5	673	608	471	542
TFS06120	Ø6 x 120	120	6	65	100	9	55	51	10	65	129	5	673	608	471	542
TFS08110	Ø8 x 110	110	8	75	100	12	65	29	20	76	152	7	857	950	600	762
TFS08130	Ø8 x 130	130	8	75	100	12	65	49	20	76	152	7	857	950	600	762
TFS10120	Ø10 x 120	120	10	85	120	14	75	26	30	88	176	8	1068	1330	748	987
TFS10140	Ø10 x 140	140	10	85	120	14	75	47	30	88	176	8	1068	1330	748	987

TFP

Homologado ETE Opt.1. Cabeza alomada con recubrimiento zincado.

CÓDIGO	MXL	LONGITUD	Ø BROCA	PROFUNDIDAD MÍN. DE TALADRO	MÍN. ESPESOR MATERIAL BASE	Ø ELEMENTO A FIJAR	PROFUNDIDAD MÍN. DEL ANCLAJE	ESPEOR MÁX. A FIJAR	PAR DE APRIETE (NM)	DISTANCIA MÍN. AL BORDE "A"	DISTANCIA MÍN. ENTRE EJES "B"	LLAVE DE INSTALACIÓN	EXTRACCIÓN HORMIGÓN NO-FISURADO	CIZALLADURA HORMIGÓN NO-FISURADO	EXTRACCIÓN HORMIGÓN FISURADO	CIZALLADURA HORMIGÓN FISURADO
TFP05040	Ø5 x 40	40	5	45	80	8	35	5	5	40	80	TX30	326	326	228	228
TFP05060	Ø5 x 60	60	5	55	80	8	45	15	5	53	105	TX30	494	398	346	346
TFP06040	Ø6 x 40	40	6	45	100	9	35	5	10	39	78	TX40	202	608	185	454
TFP06050	Ø6 x 50	50	6	45	100	9	35	15	10	39	78	TX40	202	608	185	454
TFP06060	Ø6 x 60	60	6	65	100	9	55	5	10	65	129	TX40	673	608	471	542
TFP06080	Ø6 x 80	80	6	65	100	9	55	25	10	65	129	TX40	673	608	471	542
TFP06100	Ø6 x 100	100	6	65	100	9	55	45	10	65	129	TX40	673	608	471	542
TFP08060	Ø8 x 60	60	8	60	100	12	50	10	20	57	113	TX45	457	950	320	691
TFP08080	Ø8 x 80	80	8	75	100	12	65	15	20	76	152	TX45	857	950	600	762

TFT

Homologado ETE Opt.1. Cabeza Truss con recubrimiento cincado

CÓDIGO	MXL	LONGITUD	Ø BROCA	PROFUNDIDAD MÍN. DE TALADRO	MÍN. ESPESOR MATERIAL BASE	Ø ELEMENTO A FIJAR	PROFUNDIDAD MÍN. DEL ANCLAJE	ESPEOR MÁX. A FIJAR	PAR DE APRIETE (NM)	DISTANCIA MÍN. AL BORDE "A"	DISTANCIA MÍN. ENTRE EJES "B"	LLAVE DE INSTALACIÓN	EXTRACCIÓN HORMIGÓN NO-FISURADO	CIZALLADURA HORMIGÓN NO-FISURADO	EXTRACCIÓN HORMIGÓN FISURADO	CIZALLADURA HORMIGÓN FISURADO
TFT06040	Ø6 x 40	40	6	45	100	9	35	5	10	39	78	TX30	202	608	185	454
TFT06050	Ø6 x 50	50	6	45	100	9	35	15	10	39	78	TX30	202	608	185	454
TFT06060	Ø6 x 60	60	6	65	100	9	55	5	10	65	129	TX30	673	608	471	542

TFF

Homologado ETE Opt.1. Rosca hembra métrica cincada

CÓDIGO	MXL	LONGITUD	Ø BROCA	PROFUNDIDAD MÍN. DE TALADRO	MÍN. ESPESOR MATERIAL BASE	Ø ELEMENTO A FIJAR	PROFUNDIDAD MÍN. DEL ANCLAJE	PAR DE APRIETE (NM)	DISTANCIA MÍN. AL BORDE "A"	DISTANCIA MÍN. ENTRE EJES "B"	LLAVE DE INSTALACIÓN	EXTRACCIÓN HORMIGÓN NO-FISURADO	CIZALLADURA HORMIGÓN NO-FISURADO	EXTRACCIÓN HORMIGÓN FISURADO	CIZALLADURA HORMIGÓN FISURADO
TFF06035	Ø6 x 35	35	6	45	100	--	35	10	39	78	13	202	608	185	454
TFF06055	Ø6 x 55	55	6	65	100	--	55	10	65	129	13	673	608	471	542

TFM

Homologado ETE Opt.1. Rosca macho métrica cincado

CÓDIGO	MXL	LONGITUD	Ø BROCA	PROFUNDIDAD MÍN. DE TALADRO	MÍN. ESPESOR MATERIAL BASE	Ø ELEMENTO A FIJAR	PROFUNDIDAD MÍN. DEL ANCLAJE	PAR DE APRIETE (NM)	DISTANCIA MÍN. AL BORDE "A"	DISTANCIA MÍN. ENTRE EJES "B"	LLAVE DE INSTALACIÓN	EXTRACCIÓN HORMIGÓN NO-FISURADO	CIZALLADURA HORMIGÓN NO-FISURADO	EXTRACCIÓN HORMIGÓN FISURADO	CIZALLADURA HORMIGÓN FISURADO
TFM06035	Ø6 x 35	35	6	45	100	--	35	10	39	78	13	202	608	185	454
TFM06055	Ø6 x 55	55	6	65	100	--	55	10	65	129	13	673	608	471	542

TXE

Homologado ETE Opt.1. Cabeza hexagonal con recubrimiento bimetal

CÓDIGO	MXL	LONGITUD	Ø BROCA	PROFUNDIDAD MÍN. DE TALADRO	MÍN. ESPESOR MATERIAL BASE	Ø ELEMENTO A FIJAR	PROFUNDIDAD MÍN. DEL ANCLAJE	PAR DE APRIETE (NM)	DISTANCIA MÍN. AL BORDE "A"	DISTANCIA MÍN. ENTRE EJES "B"	LLAVE DE INSTALACIÓN	EXTRACCIÓN HORMIGÓN NO-FISURADO	CIZALLADURA HORMIGÓN NO-FISURADO	EXTRACCIÓN HORMIGÓN FISURADO	CIZALLADURA HORMIGÓN FISURADO
TXE06040	Ø6 x 40	40	6	45	80	9	35	10	39	78	10	222	512	40	414
TXE06060	Ø6 x 60	60	6	65	80	9	55	10	65	129	10	485	512	303	495
TXE08070	Ø8 x 70	70	8	75	80	12	65	20	76	152	13	714	853	500	834
TXE08080	Ø8 x 80	80	8	75	80	12	65	20	76	152	13	714	853	500	834
TXE08090	Ø8 x 90	90	8	75	80	12	65	20	76	152	13	714	853	500	834
TXE08105	Ø8 x 105	105	8	75	80	12	65	20	76	152	13	714	853	500	834
TXE10070	Ø10 x 70	70	10	65	80	14	55	30	63	125	15	532	1168	372	818
TXE10090	Ø10 x 90	90	10	95	100	14	85	30	101	201	15	1091	1401	764	1401
TXE10100	Ø10 x 100	100	10	95	100	14	85	30	101	201	15	1091	1401	764	1401
TXE10120	Ø10 x 120	120	10	95	100	14	85	30	101	201	15	1091	1401	764	1401
TXE12080	Ø12 x 80	80	12	90	120	16	75	50	87	174	18	879	2029	570	1617
TXE12110	Ø12 x 110	110	12	120	160	16	105	50	126	251	18	1822	2029	1275	2029

TXA

Homologado ETE Opt.1. Cabeza avellanada con recubrimiento bimetal

CÓDIGO	MXL	LONGITUD	Ø BROCA	PROFUNDIDAD MÍN. DE TALADRO	MÍN. ESPESOR MATERIAL BASE	Ø ELEMENTO A FIJAR	PROFUNDIDAD MÍN. DEL ANCLAJE	PAR DE APRIETE (NM)	DISTANCIA MÍN. AL BORDE "A"	DISTANCIA MÍN. ENTRE EJES "B"	LLAVE DE INSTALACIÓN	EXTRACCIÓN HORMIGÓN NO-FISURADO	CIZALLADURA HORMIGÓN NO-FISURADO	EXTRACCIÓN HORMIGÓN FISURADO	CIZALLADURA HORMIGÓN FISURADO
TXA08060	Ø6 x 40	60	8	60	80	12	50	20	57	113	TX45	405	853	202	656
TXA08080	Ø6 x 60	80	8	75	80	12	65	20	76	152	TX45	714	853	500	834
TXA08120	Ø8 x 70	120	8	75	80	12	65	20	76	152	TX45	714	853	500	834
TXA10070	Ø8 x 80	70	10	65	80	14	55	30	63	125	TX50	532	1168	372	818
TXA10090	Ø8 x 90	90	10	95	100	14	85	30	101	201	TX50	1091	1401	764	1401
TXA10120	Ø8 x 105	120	10	95	100	14	85	30	101	201	TX50	1091	1401	764	1401

TXP

Homologado ETE Opt.1. Cabeza alomada con recubrimiento bimetal

CÓDIGO	MXL	LONGITUD	Ø BROCA	PROFUNDIDAD MÍN. DE TALADRO	MÍN. ESPESOR MATERIAL BASE	Ø ELEMENTO A FIJAR	PROFUNDIDAD MÍN. DEL ANCLAJE	ESPEOR MÁX. A FIJAR	PAR DE APRIETE (NM)	DISTANCIA MÍN. AL BORDE "A"	DISTANCIA MÍN. ENTRE EJES "B"	LLAVE DE INSTALACIÓN	EXTRACCIÓN HORMIGÓN NO-FISURADO	CIZALLADURA HORMIGÓN NO-FISURADO	EXTRACCIÓN HORMIGÓN FISURADO	CIZALLADURA HORMIGÓN FISURADO
TXP06050	Ø6 x 50	50	6	45	100	9	35	15	10	39	78	TX40	202	608	185	454
TXP06060	Ø6 x 60	60	6	65	100	9	55	5	10	65	129	TX40	673	608	471	542
TXP06080	Ø6 x 80	80	6	65	100	9	55	25	10	65	129	TX40	673	608	471	542
TXP06100	Ø6 x 100	100	6	65	100	9	55	45	10	65	129	TX40	673	608	471	542
TXP08060	Ø8 x 60	60	8	60	100	12	50	10	20	57	113	TX45	457	950	320	691
TXP08080	Ø8 x 80	80	8	75	100	12	65	15	20	76	152	TX45	857	950	600	762

TXT

Homologado ETE Opt.1. Cabeza Truss con recubrimiento bimetetal

CÓDIGO	MXL	LONGITUD	Ø BROCA	PROFUNDIDAD MÍN. DE TALADRO	MÍN. ESPESOR MATERIAL BASE	Ø ELEMENTO A FIJAR	PROFUNDIDAD MÍN. DEL ANCLAJE	ESPEOR MÁX. A FIJAR	PAR DE APRIETE (NM)	DISTANCIA MÍN. AL BORDE "A"	DISTANCIA MÍN. ENTRE EJES "B"	LLAVE DE INSTALACIÓN	EXTRACCIÓN HORMIGÓN NO-FISURADO	CIZALLADURA HORMIGÓN NO-FISURADO	EXTRACCIÓN HORMIGÓN FISURADO	CIZALLADURA HORMIGÓN FISURADO
TXT06040	Ø6 x 40	40	6	45	100	9	35	5	10	39	78	TX30	202	608	185	454
TXT06050	Ø6 x 50	50	6	45	100	9	35	15	10	39	78	TX30	202	608	185	454
TXT06060	Ø6 x 60	60	6	65	100	9	55	5	10	65	129	TX30	673	608	471	542

HO

Tornillo para hormigón

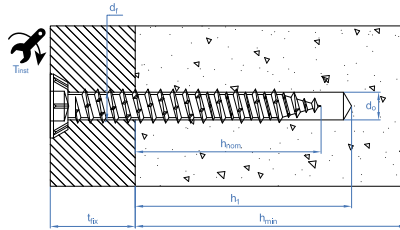

HP / HPZ

Cabeza plana, TX. Bicromatado

CÓDIGO	MXL	ESPEOR MÁX. A FIJAR	Ø BROCA	PROFUNDIDAD MÍN. DE TALADRO	PROFUNDIDAD MÍN. DEL ANCLAJE	LLAVE DE INSTALACIÓN	PAR DE APRIETE (NM)	Ø ELEMENTO A FIJAR	MÍN. ESPESOR MATERIAL BASE	EXTRACCIÓN HORMIGÓN NO-FISURADO	CIZALLADURA HORMIGÓN NO-FISURADO
HP75072	7,5 x 72	40	6	50	30	TX30	15	9	100	90	-
HP75092	7,5 x 92	60	6	50	30	TX30	15	9	100	90	-
HP75112	7,5 x 112	80	6	50	30	TX30	15	9	100	90	-
HP75132	7,5 x 132	100	6	50	30	TX30	15	9	100	90	-
HP75152	7,5 x 152	120	6	50	30	TX30	15	9	100	90	-
HP75182	7,5 x 182	150	6	50	30	TX30	15	9	100	90	-
HPZ75072	7,5 x 72	40	6	50	30	TX30	15	9	100	90	-
HPZ75092	7,5 x 92	60	6	50	30	TX30	15	9	100	90	-
HPZ75112	7,5 x 112	80	6	50	30	TX30	15	9	100	90	-
HPZ75132	7,5 x 132	100	6	50	30	TX30	15	9	100	90	-
HPZ75152	7,5 x 152	120	6	50	30	TX30	15	9	100	90	-
HPZ75182	7,5 x 182	150	6	50	30	TX30	15	9	100	90	-
HPZ75212	7,5 x 212	180	6	50	30	TX30	15	9	100	90	-

HR

Cabeza cilíndrica, Tx

CÓDIGO	MXL	ESPEOR MÁX. A FIJAR	Ø BROCA	PROFUNDIDAD MÍN. DE TALADRO	PROFUNDIDAD MÍN. DEL ANCLAJE	LLAVE DE INSTALACIÓN	PAR DE APRIETE (NM)	Ø ELEMENTO A FIJAR	MÍN. ESPESOR MATERIAL BASE	DISTANCIA MÍN. AL BORDE "A"	DISTANCIA MÍN. ENTRE EJES "B"	EXTRACCIÓN HORMIGÓN NO-FISURADO	CIZALLADURA HORMIGÓN NO-FISURADO
HR75072	7,5 x 72	32	6	45	40	TX30	15	9	100	-	-	100	-
HR75092	7,5 x 92	52	6	45	40	TX30	15	9	100	-	-	100	-
HR75112	7,5 x 112	72	6	45	40	TX30	15	9	100	-	-	100	-
HR75132	7,5 x 132	92	6	45	40	TX30	15	9	100	-	-	100	-

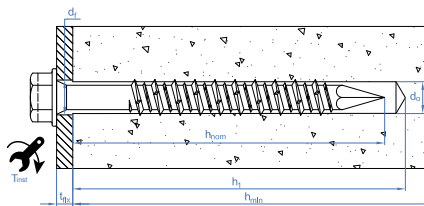

HEA

Tornillo con cabeza hexagonal

CÓDIGO	MXL	ESPEOR MÁX. A FIJAR	Ø BROCA	PROFUNDIDAD MÍN. DE TALADRO	PROFUNDIDAD MÍN. DEL ANCLAJE	LLAVE DE INSTALACIÓN	PAR DE APRIETE (NM)	Ø ELEMENTO A FIJAR	MÍN. ESPESOR MATERIAL BASE	EXTRACCIÓN HORMIGÓN NO-FISURADO	CIZALLADURA HORMIGÓN NO-FISURADO
HE65032	6,5 x 32	7	5	40	28	8+ ranura	12	8	100	-	-
HE65045	6,5 x 45	5	5	50	40	8+ ranura	12	8	100	165	-
HE65057	6,5 x 57	17	5	50	40	8+ ranura	12	8	100	165	-
HE65070	6,5 x 70	30	5	50	40	8+ ranura	12	8	100	165	-
HE65080	6,5 x 80	40	5	50	40	8+ ranura	12	8	100	165	-
HE65100	6,5 x 100	60	5	50	40	8+ ranura	12	8	100	165	-
HE65115	6,5 x 115	75	5	50	40	8+ ranura	12	8	100	165	-
HE65125	6,5 x 125	85	5	50	40	8+ ranura	12	8	100	165	-
HE65150	6,5 X 150	110	5	50	40	8+ ranura	12	8	100	165	-
HE65180	6,5 X 180	140	5	50	40	8+ ranura	12	8	100	165	-
HE65200	6,5 X 200	160	5	50	40	8+ ranura	12	8	100	165	-

HEA + ARVUL Tornillo montado con arandela vulcanizada de acero-EPDM

CÓDIGO	MXL	ESPEJOR MÁX. A FIJAR	Ø BROCA	PROFUNDIDAD MÍN. DE TALADRO	PROFUNDIDAD MÍN. DEL ANCLAJE	LLAVE DE INSTALACIÓN	PAR DE APRIETE (NM)	Ø ELEMENTO A FIJAR	MÍN. ESPESOR MATERIAL BASE	EXTRACCIÓN HORMIGÓN NO-FISURADO	CIZALLADURA HORMIGÓN NO-FISURADO
HE1665032	6,5 x 32	7	5	40	28	8+ ranura	12	8	100	65	-
HE1665045	6,5 x 45	5	5	50	40	8+ ranura	12	8	100	65	-
HE1665057	6,5 x 57	17	5	50	40	8+ ranura	12	8	100	65	-
HE1665070	6,5 x 70	30	5	50	40	8+ ranura	12	8	100	65	-
HE1665080	6,5 x 80	40	5	50	40	8+ ranura	12	8	100	65	-
HE1665100	6,5 x 100	60	5	50	40	8+ ranura	12	8	100	65	-
HE1665115	6,5 x 115	75	5	50	40	8+ ranura	12	8	100	65	-
HE1665125	6,5 x 125	85	5	50	40	8+ ranura	12	8	100	65	-
HE1665150	6,5 X 150	110	5	50	40	8+ ranura	12	8	100	65	-
HE1665180	6,5 X 180	140	5	50	40	8+ ranura	12	8	100	65	-
HE1665200	6,5 X 200	160	5	50	40	8+ ranura	12	8	100	65	-

SL Anclaje de seguridad para grandes cargas en hormigón

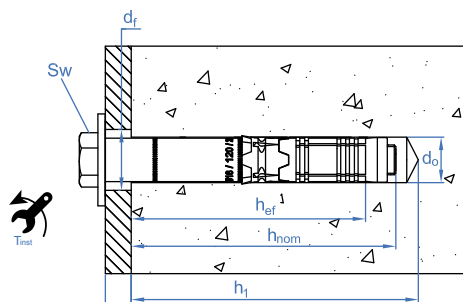

SL-PT Homologado ETE Opt.1. Cabeza hexagonal

CÓDIGO	MXL	ESPEJOR MÁX. A FIJAR	Ø BROCA	PROFUNDIDAD MÍN. DE TALADRO	PROFUNDIDAD MÍN. DEL ANCLAJE	LLAVE DE INSTALACIÓN	PAR DE APRIETE (NM)	Ø ELEMENTO A FIJAR	MÍN. ESPESOR MATERIAL BASE	DISTANCIA MÍN. AL BORDE "A"	DISTANCIA MÍN. ENTRE EJES "B"	EXTRACCIÓN HORMIGÓN NO-FISURADO	CIZALLADURA HORMIGÓN NO-FISURADO	EXTRACCIÓN HORMIGÓN FISURADO	CIZALLADURA HORMIGÓN FISURADO
SLPT10070	M6 x 70	10	10	70	59	10	15	12	100	75	150	728	844	591	591
SLPT10080	M6 x 80	20	10	70	59	10	15	12	100	75	150	728	844	591	591
SLPT10100	M6x 100	40	10	70	59	10	15	12	100	75	150	728	844	591	591
SLPT10110	M6 x 110	50	10	70	59	10	15	12	100	75	150	728	844	591	591
SLPT12080	M8 x 80	5	12	85	72	13	30	14	120	90	180	971	1922	777	1554
SLPT12090	M8 x 90	15	12	85	72	13	30	14	120	90	180	971	1922	777	1554
SLPT12100	M8 x 100	25	12	85	72	13	30	14	120	90	180	971	1922	777	1554
SLPT12120	M8 x 120	45	12	85	72	13	30	14	120	90	180	971	1922	777	1554
SLPT16100	M10 x 100	15	16	95	83	17	50	18	140	105	210	1399	2797	979	1958
SLPT16120	M10 x 120	35	16	95	83	17	50	18	140	105	210	1399	2797	979	1958
SLPT16140	M10 x 140	55	16	95	83	17	50	18	140	105	210	1399	2797	979	1958
SLPT16160	M10 x 160	75	16	95	83	17	50	18	140	105	210	1399	2797	979	1958
SLPT18110	M12 x 110	10	18	110	97	19	80	20	170	130	255	1871	3743	1310	2620
SLPT18120	M12 x 120	20	18	110	97	19	80	20	170	130	255	1871	3743	1310	2620
SLPT18140	M12 x 140	40	18	110	97	19	80	20	170	130	255	1871	3743	1310	2620
SLPT18150	M12 x 150	50	18	110	97	19	80	20	170	130	255	1871	3743	1310	2620
SLPT18170	M12 x 170	70	18	110	97	19	80	20	170	130	255	1871	3743	1310	2620
SLPT18200	M12 x 200	100	18	110	97	19	80	20	170	130	255	1871	3743	1310	2620
SLPT24140	M16 x 140	20	24	130	117	24	160	26	200	150	300	1990	4776	1393	3343
SLPT24170	M16 x 170	50	24	130	117	24	160	26	200	150	300	1990	4776	1393	3343
SLPT24200	M16 x 200	80	24	130	117	24	160	26	200	150	300	1990	4776	1393	3343
SLPT24220	M16 x 220	100	24	130	117	24	160	26	200	150	300	1990	4776	1393	3343
SLPT28170	M20 x 170	20	28	160	146	30	240	31	250	190	375	2781	6674	1947	4672
SLPT28200	M20 x 200	50	28	160	146	30	240	31	250	190	375	2781	6674	1947	4672
SLPT28240	M20 x 240	90	28	160	146	30	240	31	250	190	375	2781	6674	1947	4672

SL-PC Homologado ETE Opt.1. Cabeza avellanada

CÓDIGO	MXL	ESPEJOR MÁX. A FIJAR	Ø BROCA	PROFUNDIDAD MÍN. DE TALADRO	PROFUNDIDAD MÍN. DEL ANCLAJE	LLAVE DE INSTALACIÓN	PAR DE APRIETE (NM)	Ø ELEMENTO A FIJAR	MÍN. ESPESOR MATERIAL BASE	DISTANCIA MÍN. AL BORDE "A"	DISTANCIA MÍN. ENTRE EJES "B"	EXTRACCIÓN HORMIGÓN NO-FISURADO	CIZALLADURA HORMIGÓN NO-FISURADO	EXTRACCIÓN HORMIGÓN FISURADO	CIZALLADURA HORMIGÓN FISURADO
SLPC10070	M6 x 70	10	10	70	59	4	15	12	100	75	150	782	844	591	591
SLPC10080	M6 x 80	20	10	70	59	4	15	12	100	75	150	782	844	591	591
SLPC10100	M6 x 100	40	10	70	59	4	15	12	100	75	150	782	844	591	591
SLPC12100	M8 x 100	25	12	85	72	5	30	14	120	90	180	1110	1922	777	1554
SLPC16100	M10 x 100	15	16	95	83	6	50	18	140	105	210	1399	2797	979	1958
SLPC16120	M10 x 120	35	16	95	83	6	50	18	140	105	210	1399	2797	979	1958
SLPC18120	M12 x 120	20	18	110	97	8	80	20	170	130	255	1871	3743	1310	2620

SL-PE

Homologado ETE Opt.1. Cabeza espárrago

CÓDIGO	MXL	ESPESOR MÁX. A FIJAR	Ø BROCA	PROFUNDIDAD MÍN. DE TALADRO	PROFUNDIDAD MÍN. DEL ANCLAJE	LLAVE DE INSTALACIÓN	PAR DE APRIETE (NM)	Ø ELEMENTO A FIJAR	MÍN. ESPESOR MATERIAL BASE	DISTANCIA MÍN. AL BORDE "A"	DISTANCIA MÍN. ENTRE EJES "B"	EXTRACCIÓN HORMIGÓN NO-FISURADO	CIZALLADURA HORMIGÓN NO-FISURADO	EXTRACCIÓN HORMIGÓN FISURADO	CIZALLADURA HORMIGÓN FISURADO
SLPE12095	M8 x 95	20	12	85	72	13	30	14	120	90	180	971	1922	777	1554
SLPE12155	M8 x 155	80	12	85	72	13	30	14	120	90	180	971	1922	777	1554
SLPE16125	M10 x 125	40	16	95	83	17	50	18	140	105	210	1399	2797	979	1958
SLPE16160	M10 x 160	75	16	95	83	17	50	18	140	105	210	1399	2797	979	1958
SLPE16245	M10 x 245	160	16	95	83	17	50	18	140	105	210	1399	2797	979	1958
SLPE18150	M12 x 150	50	18	110	97	19	80	20	170	130	255	1871	3743	1310	2620
SLPE18170	M12 x 170	70	18	110	97	19	80	20	170	130	255	1871	3743	1310	2620
SLPE18260	M12 x 260	160	18	110	97	19	80	20	170	130	255	1871	3743	1310	2620
SLPE24145	M16 x 145	25	24	130	117	24	160	26	200	150	300	1990	4776	1393	3343
SLPE24170	M16 x 170	50	24	130	117	24	160	26	200	150	300	1990	4776	1393	3343
SLPE24200	M16 x 200	80	24	130	117	24	160	26	200	150	300	1990	4776	1393	3343
SLPE24280	M16 x 280	160	24	130	117	24	160	26	200	150	300	1990	4776	1393	3343
SLPE28210	M20 x 210	60	28	160	146	30	240	31	250	190	375	2781	6674	1947	4672
SLPE28230	M20 x 230	80	28	160	146	30	240	31	250	190	375	2781	6674	1947	4672
SLPE28310	M20 x 310	160	28	160	146	30	240	31	250	190	375	2781	6674	1947	4672

CH

Anclaje antigiro para cargas medias

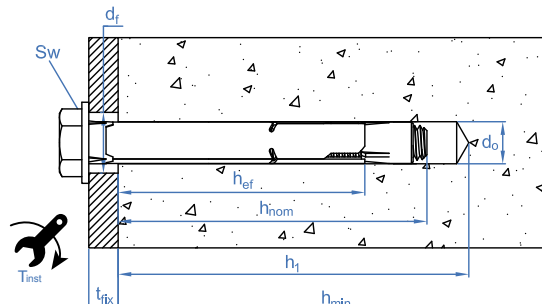

CH-TO

Tornillo hexagonal 6.8. Homologado ETE Opt.7

CÓDIGO	MXL	ESPESOR MÁX. A FIJAR	Ø BROCA	PROFUNDIDAD MÍN. DE TALADRO	PROFUNDIDAD MÍN. DEL ANCLAJE	LLAVE DE INSTALACIÓN	PAR DE APRIETE (NM)	Ø ELEMENTO A FIJAR	MÍN. ESPESOR MATERIAL BASE	DISTANCIA MÍN. AL BORDE "A"	DISTANCIA MÍN. ENTRE EJES "B"	EXTRACCIÓN HORMIGÓN NO-FISURADO	CIZALLADURA HORMIGÓN NO-FISURADO
ACHT08C	M6 x 45	5	8	45	39	10	10	9	100	41	41	267	351
ACHT08L	M6 x 60	20	8	45	39	10	10	9	100	41	41	267	351
ACHT09C	M6 x 45	5	9	45	39	10	10	10	100	41	41	267	351
ACHT09L	M6 x 60	20	9	45	39	10	10	10	100	41	41	267	351
ACHT10C	M8 x 60	5	10	60	51	13	20	12	100	54	54	485	604
ACHT10L	M8 x 80	27	10	60	51	13	20	12	100	54	54	485	604
ACHT11C	M8 x 60	5	11	60	51	13	20	13	100	54	54	485	604
ACHT11L	M8 x 80	27	11	60	51	13	20	13	100	54	54	485	604
ACHT12C	M10 x 70	5	12	75	65	17	35	14	100	65	65	662	794
ACHT12L	M10 x 100	32	12	75	65	17	35	14	100	65	65	662	794
ACHT14C	M10 x 70	5	14	75	65	17	35	16	100	65	65	662	794
ACHT14L	M10 x 100	32	14	75	65	17	35	16	100	65	65	662	794
ACHT16C	M12 x 80	5	16	80	70	19	50	18	110	74	74	812	974
ACHT16L	M12 x 110	37	16	80	70	19	50	18	110	74	74	812	974
ACHT20C	M16 x 110	15	20	105	92	24	140	22	145	97	97	1459	2744
ACHT25C	M20 x 130	25	25	130	102	30	240	27	160	120	240	1424	3417

CH-A2

Inoxidable A2. Homologado ETE Opt.7

CÓDIGO	MXL	ESPESOR MÁX. A FIJAR	Ø BROCA	PROFUNDIDAD MÍN. DE TALADRO	PROFUNDIDAD MÍN. DEL ANCLAJE	LLAVE DE INSTALACIÓN	PAR DE APRIETE (NM)	Ø ELEMENTO A FIJAR	MÍN. ESPESOR MATERIAL BASE	DISTANCIA MÍN. AL BORDE "A"	DISTANCIA MÍN. ENTRE EJES "B"	EXTRACCIÓN HORMIGÓN NO-FISURADO	CIZALLADURA HORMIGÓN NO-FISURADO
ACHTA208C	M6 x 45	5	8	45	39	10	10	9	100	41	41	392	329
ACHTA208L	M6 x 60	20	8	45	39	10	10	9	100	41	41	392	329
ACHTA209C	M6 x 45	5	9	45	39	10	10	10	100	41	41	392	329
ACHTA209L	M6 x 60	20	9	45	39	10	10	10	100	41	41	392	329
ACHTA210C	M8 x 60	5	10	60	51	13	20	12	100	54	54	384	600
ACHTA210L	M8 x 80	27	10	60	51	13	20	12	100	54	54	384	600
ACHTA211C	M8 x 60	5	11	60	51	13	20	13	100	54	54	384	600
ACHTA211L	M8 x 80	27	11	60	51	13	20	13	100	54	54	384	600
ACHTA212C	M10 x 70	5	12	75	65	17	35	14	100	65	65	566	794
ACHTA212L	M10 x 100	32	12	75	65	17	35	14	100	65	65	566	794
ACHTA214C	M10 x 70	5	14	75	65	17	35	16	100	65	65	566	794
ACHTA214L	M10 x 100	32	14	75	65	17	35	16	100	65	65	566	794
ACHTA216C	M12 x 80	5	16	80	70	19	50	18	110	74	74	647	974
ACHTA216L	M12 x 110	37	16	80	70	19	50	18	110	74	74	647	974
ACHTA220C	M16 x 110	15	20	105	92	24	140	22	145	97	97	971	2572

CH-8.8

Tornillo hexagonal 8.8. Homologado ETE Opt.7

CÓDIGO	MXL	ESPESOR MÁX. A FIJAR	Ø BROCA	PROFUNDIDAD MÍN. DE TALADRO	PROFUNDIDAD MÍN. DEL ANCLAJE	LLAVE DE INSTALACIÓN	PAR DE APRIETE (NM)	Ø ELEMENTO A FIJAR	MÍN. ESPESOR MATERIAL BASE	DISTANCIA MÍN. AL BORDE "A"	DISTANCIA MÍN. ENTRE EJES "B"	EXTRACCIÓN HORMIGÓN NO-FISURADO	CIZALLADURA HORMIGÓN NO-FISURADO
ACHT8808C	M6 x 45	5	8	45	39	10	10	9	100	41	41	267	392
ACHT8808L	M6 x 60	20	8	45	39	10	10	9	100	41	41	267	392
ACHT8810C	M8 x 60	5	10	60	51	13	20	12	100	54	54	485	604
ACHT8810L	M8 x 80	27	10	60	51	13	20	12	100	54	54	485	604
ACHT8812C	M10 x 70	5	12	75	65	17	35	14	100	65	65	662	794
ACHT8812L	M10 x 100	32	12	75	65	17	35	14	100	65	65	662	794
ACHT8816C	M12 x 80	5	16	80	70	19	50	18	110	74	74	812	974
ACHT8816L	M12 x 110	37	16	80	70	19	50	18	110	74	74	812	974
ACHT8820C	M16 x 110	15	20	105	92	24	140	22	145	97	97	1459	2918

CH-8.8 E

Tornillo hexagonal 8.8 para espesores reducidos

CÓDIGO	MXL	ESPESOR MÁX. A FIJAR	Ø BROCA	PROFUNDIDAD MÍN. DE TALADRO	PROFUNDIDAD MÍN. DEL ANCLAJE	LLAVE DE INSTALACIÓN	PAR DE APRIETE (NM)	Ø ELEMENTO A FIJAR	MÍN. ESPESOR MATERIAL BASE	DISTANCIA MÍN. AL BORDE "A"	DISTANCIA MÍN. ENTRE EJES "B"	EXTRACCIÓN HORMIGÓN NO-FISURADO	CIZALLADURA HORMIGÓN NO-FISURADO
ACHT8808E	M6 x 40	5	8	40	32	10	10	9	70	41	54	215	298
ACHT8810E	M8 x 40	5	10	45	37	13	20	12	70	41	54	249	298

CH-PL

Cabeza plana. Homologado ETE Opt.7. Homologado ETE Opción 7

CÓDIGO	MXL	ESPESOR MÁX. A FIJAR	Ø BROCA	PROFUNDIDAD MÍN. DE TALADRO	PROFUNDIDAD MÍN. DEL ANCLAJE	LLAVE DE INSTALACIÓN	PAR DE APRIETE (NM)	Ø ELEMENTO A FIJAR	MÍN. ESPESOR MATERIAL BASE	DISTANCIA MÍN. AL BORDE "A"	DISTANCIA MÍN. ENTRE EJES "B"	EXTRACCIÓN HORMIGÓN NO-FISURADO	CIZALLADURA HORMIGÓN NO-FISURADO
ACHTPL08C	M6 x 45	5	8	45	39	4	10	9	100	41	41	267	392
ACHTPL08L	M6 x 60	20	8	45	39	4	10	9	100	41	41	267	392
ACHTPL10C	M8 x 60	5	10	60	51	5	20	12	100	54	54	485	604
ACHTPL10L	M8 x 80	27	10	60	51	5	20	12	100	54	54	485	604
ACHTPL12C	M10 x 70	5	12	75	65	6	35	14	100	65	65	662	794
ACHTPL12L	M10 x 100	32	12	75	65	6	35	14	100	65	65	662	794

CH-INB

Cabeza inviolable cincada. Homologado ETE Opt.7

CÓDIGO	MXL	ESPESOR MÁX. A FIJAR	Ø BROCA	PROFUNDIDAD MÍN. DE TALADRO	PROFUNDIDAD MÍN. DEL ANCLAJE	LLAVE DE INSTALACIÓN	PAR DE APRIETE (NM)	Ø ELEMENTO A FIJAR	MÍN. ESPESOR MATERIAL BASE	DISTANCIA MÍN. AL BORDE "A"	DISTANCIA MÍN. ENTRE EJES "B"	EXTRACCIÓN HORMIGÓN NO-FISURADO	CIZALLADURA HORMIGÓN NO-FISURADO
ACHINB08C	M6 x 45	5	8	45	39	TX40	10	9	100	41	41	267	219
ACHINB08L	M6 x 60	20	8	45	39	TX40	10	9	100	41	41	267	219
ACHINB10C	M8 x 60	5	10	60	51	TX40	20	12	100	54	54	485	399
ACHINB10L	M8 x 80	27	10	60	51	TX40	20	12	100	54	54	485	399

CH-INN

Cabeza inviolable cincada negra. Homologado ETE Opt.7

CÓDIGO	MXL	ESPESOR MÁX. A FIJAR	Ø BROCA	PROFUNDIDAD MÍN. DE TALADRO	PROFUNDIDAD MÍN. DEL ANCLAJE	LLAVE DE INSTALACIÓN	PAR DE APRIETE (NM)	Ø ELEMENTO A FIJAR	MÍN. ESPESOR MATERIAL BASE	DISTANCIA MÍN. AL BORDE "A"	DISTANCIA MÍN. ENTRE EJES "B"	EXTRACCIÓN HORMIGÓN NO-FISURADO	CIZALLADURA HORMIGÓN NO-FISURADO
ACHINN08C	M6 x 45	5	8	45	39	TX40	10	9	100	41	41	267	219
ACHINN08L	M6 x 60	20	8	45	39	TX40	10	9	100	41	41	267	219
ACHINN10C	M8 x 60	5	10	60	51	TX40	20	12	100	54	54	485	399
ACHINN10L	M8 x 80	27	10	60	51	TX40	20	12	100	54	54	485	399

CH-PI

Cabeza plana inoxidable A2. Homologado ETE Opt.7

CÓDIGO	MXL	ESPESOR MÁX. A FIJAR	Ø BROCA	PROFUNDIDAD MÍN. DE TALADRO	PROFUNDIDAD MÍN. DEL ANCLAJE	LLAVE DE INSTALACIÓN	PAR DE APRIETE (NM)	Ø ELEMENTO A FIJAR	MÍN. ESPESOR MATERIAL BASE	DISTANCIA MÍN. AL BORDE "A"	DISTANCIA MÍN. ENTRE EJES "B"	EXTRACCIÓN HORMIGÓN NO-FISURADO	CIZALLADURA HORMIGÓN NO-FISURADO
ACHTPI08C	M6 x 45	5	8	45	39	4	10	9	100	41	41	392	329
ACHTPI08L	M6 x 60	20	8	45	39	4	10	9	100	41	41	392	329
ACHTPI10C	M8 x 60	5	10	60	51	5	20	12	100	54	54	384	600
ACHTPI10L	M8 x 80	27	10	60	51	5	20	12	100	54	54	384	600
ACHTPI12C	M10 x 70	5	12	75	65	6	35	14	100	65	65	566	794
ACHTPI12L	M10 x 100	32	12	75	65	6	35	14	100	65	65	566	794

CH-ES

Espárrago

CÓDIGO	MXL	ESPESOR MÁX. A FIJAR	Ø BROCA	PROFUNDIDAD MÍN. DE TALADRO	PROFUNDIDAD MÍN. DEL ANCLAJE	LLAVE DE INSTALACIÓN	PAR DE APRIETE (NM)	Ø ELEMENTO A FIJAR	MÍN. ESPESOR MATERIAL BASE	DISTANCIA MÍN. AL BORDE "A"	DISTANCIA MÍN. ENTRE EJES "B"	EXTRACCIÓN HORMIGÓN NO-FISURADO	CIZALLADURA HORMIGÓN NO-FISURADO
ACHE08C	M6 x 45	5	8	45	39	10	10	9	100	41	41	267	211
ACHE09C	M6 x 45	5	9	45	39	10	10	10	100	41	41	267	211
ACHE10C	M8 x 60	5	10	60	51	13	20	12	100	54	54	485	384
ACHE10L	M8 x 80	27	10	60	51	13	20	12	105	54	54	485	384
ACHE11C	M8 x 60	5	11	60	51	13	20	13	100	54	54	485	384
ACHE11L	M8 x 80	27	11	60	51	13	20	13	105	54	54	485	384
ACHE12C	M10 x 70	5	12	75	65	17	35	14	100	65	65	662	608
ACHE12L	M10 x 100	32	12	75	65	17	35	14	110	65	65	662	608
ACHE14C	M10 x 70	5	14	75	65	17	35	16	100	65	65	662	608
ACHE14L	M10 x 100	32	14	75	65	17	35	16	100	65	65	662	608

CH-GA

Gancho

CÓDIGO	MXL	ABERTURA GANCHO	Ø BROCA	PROFUNDIDAD MÍN. DE TALADRO	PROFUNDIDAD MÍN. DEL ANCLAJE	LLAVE DE INSTALACIÓN	PAR DE APRIETE (NM)	Ø ELEMENTO A FIJAR	MÍN. ESPESOR MATERIAL BASE	DISTANCIA MÍN. AL BORDE "A"	DISTANCIA MÍN. ENTRE EJES "B"	EXTRACCIÓN HORMIGÓN NO-FISURADO	CIZALLADURA HORMIGÓN NO-FISURADO
ACHG08C	M6 x 45	10	8	45	39	10	10	9	100	41	41	73	-
ACHG09C	M6 x 45	10	9	45	39	10	10	10	100	41	41	73	-
ACHG10C	M8 x 60	13	10	60	51	13	20	12	100	54	54	146	-

01
02
03

CARACTERÍSTICAS TÉCNICAS

CÓDIGO	MXL	ABERTURA GANCHO	Ø BROCA	PROFUNDIDAD MÍN. DE TALADRO	PROFUNDIDAD MÍN. DEL ANCLAJE	LLAVE DE INSTALACIÓN	PAR DE APRIETE (NM)	Ø ELEMENTO A FIJAR	MÍN. ESPESOR MATERIAL BASE	DISTANCIA MÍN. AL BORDE "A"	DISTANCIA MÍN. ENTRE EJES "B"	EXTRACCIÓN HORMIGÓN NO-FISURADO	CIZALLADURA HORMIGÓN NO-FISURADO
ACHG11C	M8 x 60	13	11	60	51	13	20	13	100	54	54	146	-
ACHG12C	M10 x 70	14	12	75	65	17	35	14	100	65	65	243	-
ACHG14C	M10 x 70	14	14	75	65	17	35	16	100	65	65	243	-
ACHG16C	M12 x 80	22	16	80	70	19	50	18	110	74	74	291	-

CH-GE Gancho espiral

CÓDIGO	MXL	ESPEJOR MÁX. A FIJAR	Ø BROCA	PROFUNDIDAD MÍN. DE TALADRO	PROFUNDIDAD MÍN. DEL ANCLAJE	LLAVE DE INSTALACIÓN	PAR DE APRIETE (NM)	Ø ELEMENTO A FIJAR	MÍN. ESPESOR MATERIAL BASE	DISTANCIA MÍN. AL BORDE "A"	DISTANCIA MÍN. ENTRE EJES "B"	EXTRACCIÓN HORMIGÓN NO-FISURADO	CIZALLADURA HORMIGÓN NO-FISURADO
ACHGE10	M8 x 115	-	10	60	51	13	20	12	100	41	41	146	-
ACHGE12	M10 x 135	-	12	80	70	17	35	14	100	54	54	243	-

CH-GF Gancho forjado

CÓDIGO	MXL	ABERTURA GANCHO	Ø BROCA	PROFUNDIDAD MÍN. DE TALADRO	PROFUNDIDAD MÍN. DEL ANCLAJE	LLAVE DE INSTALACIÓN	PAR DE APRIETE (NM)	Ø ELEMENTO A FIJAR	MÍN. ESPESOR MATERIAL BASE	DISTANCIA MÍN. AL BORDE "A"	DISTANCIA MÍN. ENTRE EJES "B"	EXTRACCIÓN HORMIGÓN NO-FISURADO	CIZALLADURA HORMIGÓN NO-FISURADO
ACHGF008C	M6 x 45	10	8	45	39	10	10	9	100	41	41	80	-
ACHGF010C	M8 x 60	11	10	60	51	13	20	12	100	54	54	155	-
ACHGF012C	M10 x 70	14	12	75	65	17	35	14	100	65	65	243	-

CH-GF A2 Gancho forjado. Inoxidable A2

CÓDIGO	MXL	ABERTURA GANCHO	Ø BROCA	PROFUNDIDAD MÍN. DE TALADRO	PROFUNDIDAD MÍN. DEL ANCLAJE	LLAVE DE INSTALACIÓN	PAR DE APRIETE (NM)	Ø ELEMENTO A FIJAR	MÍN. ESPESOR MATERIAL BASE	DISTANCIA MÍN. AL BORDE "A"	DISTANCIA MÍN. ENTRE EJES "B"	EXTRACCIÓN HORMIGÓN NO-FISURADO	CIZALLADURA HORMIGÓN NO-FISURADO
ACHGA208C	M6 x 45	10	8	45	39	10	10	9	100	41	41	84	-
ACHGA210C	M8 x 60	11	10	60	51	13	20	12	100	54	54	84	-
ACHGA212C	M10 x 70	14	12	75	65	17	35	14	100	65	65	155	-

CH-AR Argolla

CÓDIGO	MXL	Ø OJO	Ø BROCA	PROFUNDIDAD MÍN. DE TALADRO	PROFUNDIDAD MÍN. DEL ANCLAJE	LLAVE DE INSTALACIÓN	PAR DE APRIETE (NM)	Ø ELEMENTO A FIJAR	MÍN. ESPESOR MATERIAL BASE	DISTANCIA MÍN. AL BORDE "A"	DISTANCIA MÍN. ENTRE EJES "B"	EXTRACCIÓN HORMIGÓN NO-FISURADO	CIZALLADURA HORMIGÓN NO-FISURADO
ACHA08C	M6 x 45	10	8	45	39	10	10	9	100	41	41	73	-
ACHA09C	M6 x 45	10	9	45	39	10	10	10	100	41	41	73	-
ACHA10C	M8 x 60	13	10	60	51	13	20	12	100	54	54	146	-
ACHA11C	M8 x 60	13	11	60	51	13	20	13	100	54	54	146	-
ACHA12C	M10 x 70	14	12	75	65	17	35	14	100	65	65	243	-
ACHA14C	M10 x 70	14	14	75	65	17	35	16	100	65	65	243	-
ACHA16C	M12 x 80	22	16	80	70	19	50	18	110	74	74	291	-

CH-AF Argolla forjada

CÓDIGO	MXL	Ø OJO	Ø BROCA	PROFUNDIDAD MÍN. DE TALADRO	PROFUNDIDAD MÍN. DEL ANCLAJE	LLAVE DE INSTALACIÓN	PAR DE APRIETE (NM)	Ø ELEMENTO A FIJAR	MÍN. ESPESOR MATERIAL BASE	DISTANCIA MÍN. AL BORDE "A"	DISTANCIA MÍN. ENTRE EJES "B"	EXTRACCIÓN HORMIGÓN NO-FISURADO	CIZALLADURA HORMIGÓN NO-FISURADO
ACHAF008C	M6 x 45	10	8	45	39	10	10	9	100	41	41	204	-
ACHAF010C	M8 x 60	12	10	60	51	13	20	12	100	54	54	485	-
ACHAF012C	M10 x 70	14	12	75	65	17	35	14	100	65	65	662	-

CH-AF A2 Argolla forjada inoxidable A2

CÓDIGO	MXL	Ø OJO	Ø BROCA	PROFUNDIDAD MÍN. DE TALADRO	PROFUNDIDAD MÍN. DEL ANCLAJE	LLAVE DE INSTALACIÓN	PAR DE APRIETE (NM)	Ø ELEMENTO A FIJAR	MÍN. ESPESOR MATERIAL BASE	DISTANCIA MÍN. AL BORDE "A"	DISTANCIA MÍN. ENTRE EJES "B"	EXTRACCIÓN HORMIGÓN NO-FISURADO	CIZALLADURA HORMIGÓN NO-FISURADO
ACHAA208C	M6 x 45	10	8	45	39	10	10	9	100	41	41	164	-
ACHAA210C	M8 x 60	11	10	60	51	13	20	12	100	54	54	384	-
ACHAA212C	M10 x 70	14	12	75	65	17	35	14	100	65	65	566	-

HE Anclaje hembra con cono interior para grandes cargas

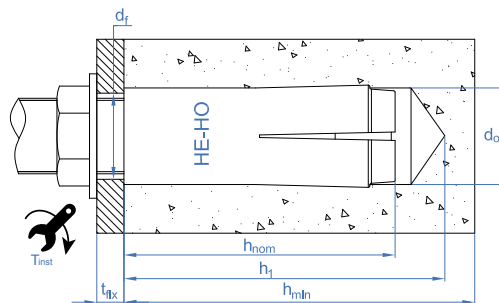

HE-HO Homologado ETE Opción 7

CÓDIGO	MXL	Ø BROCA	PROFUNDIDAD MÍN. DE TALADRO	PROFUNDIDAD MÍN. DEL ANCLAJE	PAR DE APRIETE (NM)	Ø ELEMENTO A FIJAR	MÍN. ESPESOR MATERIAL BASE	DISTANCIA MÍN. AL BORDE "A"	DISTANCIA MÍN. ENTRE EJES "B"	EXTRACCIÓN HORMIGÓN NO-FISURADO	CIZALLADURA HORMIGÓN NO-FISURADO
HEHOM06	M6	8	27	25	4	7	100	38	75	249	298
HEHOM08	M8	10	33	30	11	9	100	45	90	327	392
HEHOM10	M10	12	43	40	17	12	100	60	120	432	530
HEHOM12	M12	15	54	50	38	14	100	75	150	603	844
HEHOM16	M16	20	70	65	60	18	130	98	195	894	1893
HEHOM20	M20	25	86	80	100	22	160	120	240	1220	2767
HEHOM12D	M12	16	54	50	38	14	100	75	150	603	844

HE-A4

Inoxidable A4. Homologado ETE Aplicaciones no estructurales

CÓDIGO	MXL	Ø BROCA	PROFUNDIDAD MÍN. DE TALADRO	PROFUNDIDAD MÍN. DEL ANCLAJE	PAR DE APRIETE (NM)	Ø ELEMENTO A FIJAR	MÍN. ESPESOR MATERIAL BASE	DISTANCIA MÍN. AL BORDE "A"	DISTANCIA MÍN. ENTRE EJES "B"	EXTRACCIÓN HORMIGÓN NO-FISURADO	CIZALLADURA HORMIGÓN NO-FISURADO
HEA4M06	M6	8	27	25	4	7	80	150	200	87	87
HEA4M08	M8	10	33	30	11	9	80	150	200	121	121
HEA4M10	M10	12	43	40	17	12	80	150	200	121	121
HEA4M12	M12	15	54	50	38	14	100	150	200	225	225
HEA4M16	M16	20	70	65	60	18	130	195	260	433	433
HEA4M20	M20	25	86	80	100	22	160	240	320	572	572

HE-CL

Con collarín. Cincado. Homologado ETE Opt.7 y para aplicaciones no estructurales

CÓDIGO	MXL	Ø BROCA	PROFUNDIDAD MÍN. DE TALADRO	PROFUNDIDAD MÍN. DEL ANCLAJE	PAR DE APRIETE (NM)	Ø ELEMENTO A FIJAR	MÍN. ESPESOR MATERIAL BASE	DISTANCIA MÍN. AL BORDE "A"	DISTANCIA MÍN. ENTRE EJES "B"	EXTRACCIÓN HORMIGÓN NO-FISURADO	CIZALLADURA HORMIGÓN NO-FISURADO
HECLOM06	M6	8	27	25	4	7	100	38	75	249	298
HECLOM08	M8	10	33	30	11	9	100	45	90	327	392
HECLOM10	M10	12	43	40	17	12	100	60	120	432	530
HECLOM12	M12	15	54	50	38	14	100	75	150	603	844
HECLOM16	M16	20	70	65	60	18	130	98	195	894	1893
HECLOM12D	M12	16	54	50	38	14	100	75	150	603	844

HE-C4

Con collarín. Inoxidable A4. Homologado ETE Aplicaciones no estructurales

CÓDIGO	MXL	Ø BROCA	PROFUNDIDAD MÍN. DE TALADRO	PROFUNDIDAD MÍN. DEL ANCLAJE	PAR DE APRIETE (NM)	Ø ELEMENTO A FIJAR	MÍN. ESPESOR MATERIAL BASE	DISTANCIA MÍN. AL BORDE "A"	DISTANCIA MÍN. ENTRE EJES "B"	EXTRACCIÓN HORMIGÓN NO-FISURADO	CIZALLADURA HORMIGÓN NO-FISURADO
HEC4M06	M6	8	27	25	4	7	80	150	200	87	87
HEC4M08	M8	10	33	30	11	9	80	150	200	121	121
HEC4M10	M10	12	43	40	17	12	80	150	200	121	121
HEC4M12	M12	15	54	50	38	14	100	150	200	225	225

HE-HC

Versión corta. Cincado. Homologado ETE Aplicaciones no estructurales

CÓDIGO	MXL	Ø BROCA	PROFUNDIDAD MÍN. DE TALADRO	PROFUNDIDAD MÍN. DEL ANCLAJE	PAR DE APRIETE (NM)	Ø ELEMENTO A FIJAR	MÍN. ESPESOR MATERIAL BASE	DISTANCIA MÍN. AL BORDE "A"	DISTANCIA MÍN. ENTRE EJES "B"	EXTRACCIÓN HORMIGÓN NO-FISURADO	CIZALLADURA HORMIGÓN NO-FISURADO
HEHCM08	M8 x 25	10	28	25	11	9	80	60	120	101	101
HEHCM10	M10 x 25	12	28	25	17	12	80	60	120	162	162
HEHCM12	M12 x 25	15	29	25	38	14	80	60	120	162	162

HE-NO

Cincado

CÓDIGO	MXL	Ø BROCA	PROFUNDIDAD MÍN. DE TALADRO	PROFUNDIDAD MÍN. DEL ANCLAJE	PAR DE APRIETE (NM)	Ø ELEMENTO A FIJAR	MÍN. ESPESOR MATERIAL BASE	DISTANCIA MÍN. AL BORDE "A"	DISTANCIA MÍN. ENTRE EJES "B"	EXTRACCIÓN HORMIGÓN NO-FISURADO	CIZALLADURA HORMIGÓN NO-FISURADO
HENOM06	M6	8	27	25	4	7	100	38	75	175	298
HENOM08	M8	10	33	30	11	9	100	45	90	230	392
HENOM10	M10	12	43	40	17	12	100	60	120	354	530
HENOM12	M12	15	54	50	38	14	100	75	150	494	844
HENOM16	M16	20	70	65	60	18	130	98	195	733	1893
HENOM20	M20	25	86	80	100	22	160	120	240	1000	2767

HE-NS

Inoxidable A4. Homologado ETE Aplicaciones no estructurales

CÓDIGO	MXL	Ø BROCA	PROFUNDIDAD MÍN. DE TALADRO	PROFUNDIDAD MÍN. DEL ANCLAJE	PAR DE APRIETE (NM)	Ø ELEMENTO A FIJAR	MÍN. ESPESOR MATERIAL BASE	DISTANCIA MÍN. AL BORDE "A"	DISTANCIA MÍN. ENTRE EJES "B"	EXTRACCIÓN HORMIGÓN NO-FISURADO	CIZALLADURA HORMIGÓN NO-FISURADO
HENSM08	M8 x 30	10	33	30	11	9	100	45	90	327	392
HENSM10	M10 x 40	12	43	40	17	12	100	60	120	432	530
HENSM12	M12 x 50	15	54	50	38	14	100	75	150	603	844
HENSM16	M16 x 65	20	70	65	60	18	130	98	195	894	1893

HC

Anclaje para losa alveolar. Homologado ETE

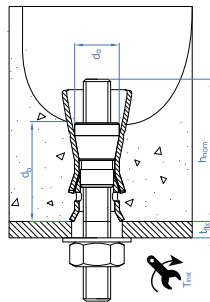

HC

Cápsula

CÓDIGO	MXL	Ø BROCA	PROFUNDIDAD MÍN. DE TALADRO	PAR DE APRIETE (NM)	Ø ELEMENTO A FIJAR	MÍN. ESPESOR MATERIAL BASE	DISTANCIA MÍN. AL BORDE "A"	DISTANCIA MÍN. ENTRE EJES "B"	EXTRACCIÓN HORMIGÓN NO-FISURADO	CIZALLADURA HORMIGÓN NO-FISURADO
HCM06	M6 x 38	10	45	10	7	25	100	200	142	142
HCM08	M8 x 44	12	50	20	9	25	100	200	243	243
HCM10	M10 x 53	16	60	30	12	25	100	200	324	324

TALA

Taco de latón para fijaciones ligeras en materiales macizos

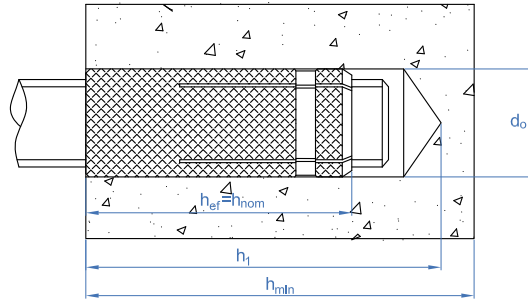

TALA

Taco de latón para fijaciones ligeras en materiales macizos

CÓDIGO	MXL	Ø BROCA	PROFUNDIDAD MÍN. DE TALADRO	MÍN. ESPESOR MATERIAL BASE	DISTANCIA MÍN. AL BORDE "A"	DISTANCIA MÍN. ENTRE EJES "B"	EXTRACCIÓN HORMIGÓN NO-FISURADO
TALA532	W5/32 x 16	5	20	25	24	48	60
TALAM04	M4 x 16	5	20	25	24	48	60
TALAM05	M5 x 18	6	22	30	27	54	70
TALAM06	M6 x 23	8	28	35	35	69	100
TALAM08	M8 x 28	10	33	40	42	84	150
TALAM10	M10 x 33	12	40	45	51	102	210
TALAM12	M12 x 38	15	45	50	57	114	320

TA-ME

Taco de expansión metálico

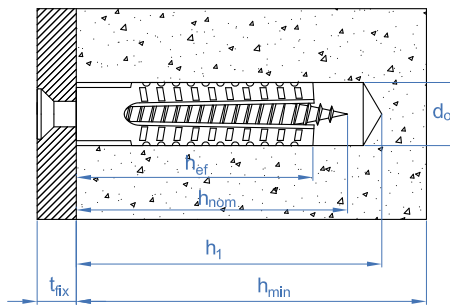

TA-ME

Taco de expansión metálico

CÓDIGO	MXL	Ø BROCA	PROFUNDIDAD MÍN. DE TALADRO	MÍN. ESPESOR MATERIAL BASE	DISTANCIA MÍN. AL BORDE "A"	DISTANCIA MÍN. ENTRE EJES "B"	EXTRACCIÓN HORMIGÓN NO-FISURADO
TAME05030	M5 x 30	5	40	60	60	120	20
TAME06032	M6 x 32	6	40	60	60	120	22
TAME08038	M8 x 38	8	50	70	70	140	40
TAME08060	M8 x 60	8	70	120	120	240	47
TAME10060	M10 x 60	10	70	120	120	240	52

AN-CU

Anclaje metálico tipo cuña. Homologado ETE

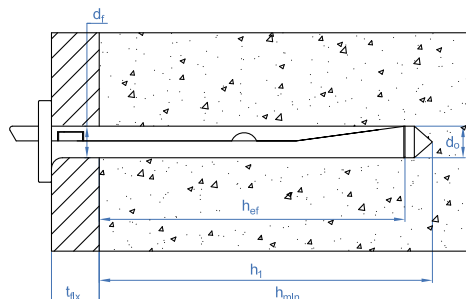

AN-CU

Anclaje metálico tipo cuña

CÓDIGO	MXL	ESPEJOR MÁX. A FIJAR	Ø BROCA	PROFUNDIDAD MÍN. DE TALADRO	Ø ELEMENTO A FIJAR	MÍN. ESPESOR MATERIAL BASE	DISTANCIA MÍN. AL BORDE "A"	DISTANCIA MÍN. ENTRE EJES "B"	EXTRACCIÓN HORMIGÓN NO-FISURADO
ANCU06040	6 x 40	5	6	40	7	80	150	200	120
ANCU06070	6 x 70	35	6	40	7	80	150	200	120

NA

Anclaje metálico tipo cuña. Homologado ETE

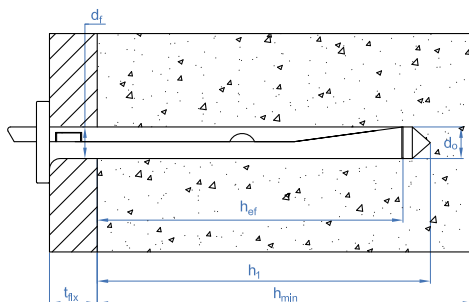

NA-C

Cabeza plana. Eje zincado. Clip ATLANTIS C3-L

CÓDIGO	MXL	ESPESOR MÁX. A FIJAR	Ø BROCA	PROFUNDIDAD MÍN. DE TALADRO	Ø ELEMENTO A FIJAR	MÍN. ESPESOR MATERIAL BASE	DISTANCIA MÍN. AL BORDE "A"	DISTANCIA MÍN. ENTRE EJES "B"	EXTRACCIÓN HORMIGÓN NO-FISURADO
NAC6035	6 x 35	5	6	35	7	80	50	75	243
NAC6040	6 x 40	5	6	40	7	80	65	90	243
NAC6045	6 x 45	10	6	40	7	80	65	90	243
NAC6050	6 x 50	15	6	40	7	80	65	90	243
NAC6055	6 x 55	20	6	40	7	80	65	90	243
NAC6065	6 x 65	30	6	40	7	80	65	90	243
NAC6085	6 x 85	50	6	40	7	80	65	90	243
NAC6110	6 x 110	75	6	40	7	80	65	90	243

NA-E

Espárrago. Eje zincado. Clip ATLANTIS C3-L

CÓDIGO	MXL	ESPESOR MÁX. A FIJAR	Ø BROCA	PROFUNDIDAD MÍN. DE TALADRO	Ø ELEMENTO A FIJAR	MÍN. ESPESOR MATERIAL BASE	DISTANCIA MÍN. AL BORDE "A"	DISTANCIA MÍN. ENTRE EJES "B"	EXTRACCIÓN HORMIGÓN NO-FISURADO
NAE6045	6 x 45	1	6	40	7	80	65	90	243
NAE6050	6 x 50	6	6	40	7	80	65	90	243
NAE6055	6 x 55	11	6	40	7	80	65	90	243

NA-F

Rosca hembra. Eje zincado. Clip ATLANTIS C3-L

CÓDIGO	MXL	ESPESOR MÁX. A FIJAR	Ø BROCA	PROFUNDIDAD MÍN. DE TALADRO	Ø ELEMENTO A FIJAR	MÍN. ESPESOR MATERIAL BASE	DISTANCIA MÍN. AL BORDE "A"	DISTANCIA MÍN. ENTRE EJES "B"	EXTRACCIÓN HORMIGÓN NO-FISURADO
NAF65810	6 x 58	-	6	40	-	80	65	90	243
NAF66310	6 x 63	-	6	40	-	80	65	90	243

NA-G

Gancho. Eje zincado. Clip ATLANTIS C3-L

CÓDIGO	MXL	ESPESOR MÁX. A FIJAR	Ø BROCA	PROFUNDIDAD MÍN. DE TALADRO	Ø ELEMENTO A FIJAR	MÍN. ESPESOR MATERIAL BASE	DISTANCIA MÍN. AL BORDE "A"	DISTANCIA MÍN. ENTRE EJES "B"	EXTRACCIÓN HORMIGÓN NO-FISURADO
NAG6055	6 x 55	-	6	-	-	80	65	90	73

NA-R

Argolla. Eje zincado. Clip ATLANTIS C3-L

CÓDIGO	MXL	ESPESOR MÁX. A FIJAR	Ø BROCA	PROFUNDIDAD MÍN. DE TALADRO	Ø ELEMENTO A FIJAR	MÍN. ESPESOR MATERIAL BASE	DISTANCIA MÍN. AL BORDE "A"	DISTANCIA MÍN. ENTRE EJES "B"	EXTRACCIÓN HORMIGÓN NO-FISURADO
NAR6055	6 x 55	-	6	-	-	80	65	90	73

ZA

Anclaje para cargas medias-altas en materiales macizos o huecos

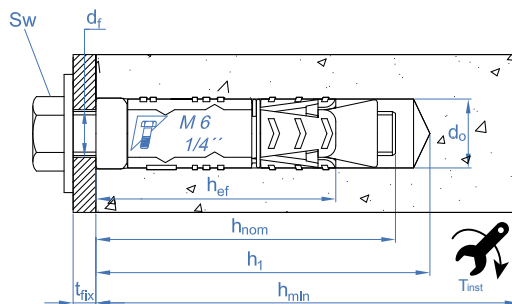

ZA-CA

Cápsula

CÓDIGO	MXL	ESPESOR MÁX. A FIJAR	Ø BROCA	PROFUNDIDAD MÍN. DE TALADRO	PROFUNDIDAD MÍN. DEL ANCLAJE	PAR DE APRIETE (NM)	Ø ELEMENTO A FIJAR	MÍN. ESPESOR MATERIAL BASE	DISTANCIA MÍN. AL BORDE "A"	DISTANCIA MÍN. ENTRE EJES "B"	EXTRACCIÓN HORMIGÓN NO-FISURADO	CIZALLADURA HORMIGÓN NO-FISURADO
AZAMC06	M6 x 48	-	12	60	48	7	7	100	62	125	513	351
AZAMC08	M8 x 50	-	14	65	50	15	9	100	65	130	561	640
AZAMC10	M10 x 58	-	16	75	58	30	12	102	80	155	725	870
AZAMC12	M12 x 72	-	20	90	72	50	14	122	95	185	865	1473
AZAMC16	M16 x 107	-	25	125	107	120	18	192	145	290	1053	2744

ZA-TO		Tornillo											
CÓDIGO	MXL	ESPESOR MÁX. A FIJAR	Ø BROCA	PROFUNDIDAD MÍN. DE TALADRO	PROFUNDIDAD MÍN. DEL ANCLAJE	LLAVE DE INSTALACIÓN	PAR DE APRIETE (NM)	Ø ELEMENTO A FIJAR	MÍN. ESPESOR MATERIAL BASE	DISTANCIA MÍN. AL BORDE "A"	DISTANCIA MÍN. ENTRE EJES "B"	EXTRACCIÓN HORMIGÓN NO-FISURADO	CIZALLADURA HORMIGÓN NO-FISURADO
AZAMT06	M6 x 50	1	12	60	48	10	7	7	100	62	125	513	351
AZAMT08	M8 x 60	10	14	65	50	13	15	9	100	65	130	561	640
AZAMT10	M10 x 80	20	16	75	58	17	30	12	102	80	155	725	870
AZAMT12	M12 x 100	25	20	90	72	19	50	14	122	95	185	865	1473
AZAMT16	M16 x 140	30	25	125	107	24	120	18	192	145	290	1053	2744

ZA-ES		Espárrago											
CÓDIGO	MXL	ESPESOR MÁX. A FIJAR	Ø BROCA	PROFUNDIDAD MÍN. DE TALADRO	PROFUNDIDAD MÍN. DEL ANCLAJE	LLAVE DE INSTALACIÓN	PAR DE APRIETE (NM)	Ø ELEMENTO A FIJAR	MÍN. ESPESOR MATERIAL BASE	DISTANCIA MÍN. AL BORDE "A"	DISTANCIA MÍN. ENTRE EJES "B"	EXTRACCIÓN HORMIGÓN NO-FISURADO	CIZALLADURA HORMIGÓN NO-FISURADO
AZAME06	M6 x 60	1	12	60	48	10	7	7	100	62	125	415	246
AZAME08	M8 x 70	10	14	65	50	13	15	9	100	65	130	561	448
AZAME10	M10 x 100	30	16	75	58	17	30	12	102	80	155	725	709
AZAME12	M12 x 120	30	20	90	72	19	50	14	122	95	185	865	1031
AZAME16	M16 x 140	12	25	125	107	24	120	18	192	145	290	1053	1920

ZA-GA		Gancho											
CÓDIGO	MXL	ABERTURA GANCHO	Ø BROCA	PROFUNDIDAD MÍN. DE TALADRO	PROFUNDIDAD MÍN. DEL ANCLAJE	LLAVE DE INSTALACIÓN	PAR DE APRIETE (NM)	Ø ELEMENTO A FIJAR	MÍN. ESPESOR MATERIAL BASE	DISTANCIA MÍN. AL BORDE "A"	DISTANCIA MÍN. ENTRE EJES "B"	EXTRACCIÓN HORMIGÓN NO-FISURADO	CIZALLADURA HORMIGÓN NO-FISURADO
AZAMG06	M6 x 48	10	12	60	48	10	7	7	100	62	125	73	-
AZAMG08	M8 x 50	13	14	65	50	13	15	9	100	65	130	146	-
AZAMG10	M10 x 58	14	16	75	58	17	30	12	102	80	155	243	-
AZAMG12	M12 x 72	22	20	90	72	19	50	14	122	95	185	291	-

ZA-GF		Gancho forjado											
CÓDIGO	MXL	ABERTURA GANCHO	Ø BROCA	PROFUNDIDAD MÍN. DE TALADRO	PROFUNDIDAD MÍN. DEL ANCLAJE	LLAVE DE INSTALACIÓN	PAR DE APRIETE (NM)	Ø ELEMENTO A FIJAR	MÍN. ESPESOR MATERIAL BASE	DISTANCIA MÍN. AL BORDE "A"	DISTANCIA MÍN. ENTRE EJES "B"	EXTRACCIÓN HORMIGÓN NO-FISURADO	CIZALLADURA HORMIGÓN NO-FISURADO
AZAMGF006	M6 x 60	10	12	60	48	10	7	7	100	62	125	80	-
AZAMGF008	M8 x 70	11	14	65	50	13	15	9	100	65	130	155	-
AZAMGF010	M10 x 100	14	16	75	58	17	30	12	102	80	155	243	-
AZAMGF012	M12 x 120	18	20	90	72	19	50	14	122	95	185	396	-

ZA-AR		Argolla											
CÓDIGO	MXL	Ø OJO	Ø BROCA	PROFUNDIDAD MÍN. DE TALADRO	PROFUNDIDAD MÍN. DEL ANCLAJE	LLAVE DE INSTALACIÓN	PAR DE APRIETE (NM)	Ø ELEMENTO A FIJAR	MÍN. ESPESOR MATERIAL BASE	DISTANCIA MÍN. AL BORDE "A"	DISTANCIA MÍN. ENTRE EJES "B"	EXTRACCIÓN HORMIGÓN NO-FISURADO	CIZALLADURA HORMIGÓN NO-FISURADO
AZAMA06	M6 x 48	10	12	60	48	10	7	7	100	62	125	73	-
AZAMA08	M8 x 50	13	14	65	50	13	15	9	100	65	130	146	-
AZAMA10	M10 x 58	14	16	75	58	17	30	12	102	80	155	243	-
AZAMA12	M12 x 72	22	20	90	72	19	50	14	122	95	185	291	-

ZA-AF		Argolla forjada											
CÓDIGO	MXL	Ø OJO	Ø BROCA	PROFUNDIDAD MÍN. DE TALADRO	PROFUNDIDAD MÍN. DEL ANCLAJE	LLAVE DE INSTALACIÓN	PAR DE APRIETE (NM)	Ø ELEMENTO A FIJAR	MÍN. ESPESOR MATERIAL BASE	DISTANCIA MÍN. AL BORDE "A"	DISTANCIA MÍN. ENTRE EJES "B"	EXTRACCIÓN HORMIGÓN NO-FISURADO	CIZALLADURA HORMIGÓN NO-FISURADO
AZAMAF006	M6 x 48	10	12	60	48	10	7	7	100	62	125	204	-
AZAMAF008	M8 x 50	12	14	65	50	13	15	9	100	65	130	555	-
AZAMAF010	M10 x 58	14	16	75	58	17	30	12	102	80	155	725	-
AZAMAF012	M12 x 72	17	20	90	72	19	50	14	122	95	185	820	-

AC Anclaje de acero con aletas para cargas altas

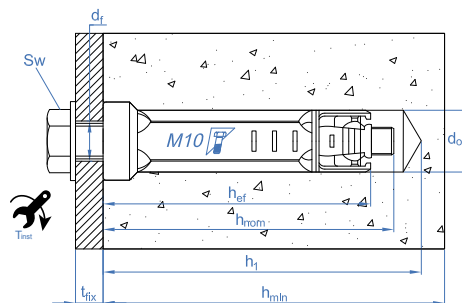

AC-CA		Cápsula											
CÓDIGO	MXL	ESPESOR MÁX. A FIJAR	Ø BROCA	PROFUNDIDAD MÍN. DE TALADRO	PROFUNDIDAD MÍN. DEL ANCLAJE	PAR DE APRIETE (NM)	Ø ELEMENTO A FIJAR	MÍN. ESPESOR MATERIAL BASE	DISTANCIA MÍN. AL BORDE "A"	DISTANCIA MÍN. ENTRE EJES "B"	EXTRACCIÓN HORMIGÓN NO-FISURADO	CIZALLADURA HORMIGÓN NO-FISURADO	
AACCA06	M6 x 40	-	10	45	40	10	7	100	60	120	92	351	
AACCA08	M8 x 50	-	14	60	50	25	9	100	75	150	98	640	
AACCA10	M10 x 60	-	16	70	60	50	12	120	90	180	441	1014	
AACCA12	M12 x 80	-	20	90	80	85	14	160	120	240	571	1473	
AACCA16	M16 x 100	-	25	110	100	120	18	200	150	300	698	2744	

AC-CI

Cápsula. Inoxidable A4

CÓDIGO	MXL	ESPEJOR MÁX. A FIJAR	Ø BROCA	PROFUNDIDAD MÍN. DE TALADRO	PROFUNDIDAD MÍN. DEL ANCLAJE	PAR DE APRIETE (NM)	Ø ELEMENTO A FIJAR	MÍN. ESPESOR MATERIAL BASE	DISTANCIA MÍN. AL BORDE "A"	DISTANCIA MÍN. ENTRE EJES "B"	EXTRACCIÓN HORMIGÓN NO-FISURADO	CIZALLADURA HORMIGÓN NO-FISURADO
AACCI06	M6 x 40	-	10	45	40	10	7	100	60	120	92	329
AACCI08	M8 x 50	-	14	60	50	25	9	100	75	150	98	600
AACCI10	M10 x 60	-	16	70	60	50	12	120	90	180	441	950
AACCI12	M12 x 80	-	20	90	80	85	14	160	120	240	571	1381

AC-TO

Tornillo 6.8

CÓDIGO	MXL	ESPEJOR MÁX. A FIJAR	Ø BROCA	PROFUNDIDAD MÍN. DE TALADRO	PROFUNDIDAD MÍN. DEL ANCLAJE	LLAVE DE INSTALACIÓN	PAR DE APRIETE (NM)	Ø ELEMENTO A FIJAR	MÍN. ESPESOR MATERIAL BASE	DISTANCIA MÍN. AL BORDE "A"	DISTANCIA MÍN. ENTRE EJES "B"	EXTRACCIÓN HORMIGÓN NO-FISURADO	CIZALLADURA HORMIGÓN NO-FISURADO
AACTO06	M6 x 50	8	10	45	40	10	10	7	100	60	120	92	351
AACTO08	M8 x 60	8	14	60	50	13	25	9	100	75	150	98	640
AACTO10	M10 x 70	8	16	70	60	17	50	12	120	90	180	441	1014
AACTO12	M12 x 125	18	20	90	80	19	85	14	160	120	240	571	1473
AACTO16	M16 x 125	17	25	110	100	24	120	18	200	150	300	698	2744

AC-ES

Espárrago

CÓDIGO	MXL	ESPEJOR MÁX. A FIJAR	Ø BROCA	PROFUNDIDAD MÍN. DE TALADRO	PROFUNDIDAD MÍN. DEL ANCLAJE	LLAVE DE INSTALACIÓN	PAR DE APRIETE (NM)	Ø ELEMENTO A FIJAR	MÍN. ESPESOR MATERIAL BASE	DISTANCIA MÍN. AL BORDE "A"	DISTANCIA MÍN. ENTRE EJES "B"	EXTRACCIÓN HORMIGÓN NO-FISURADO	CIZALLADURA HORMIGÓN NO-FISURADO
AACES06	M6 x 60	8	10	45	40	10	10	7	100	60	120	92	246
AACES08	M8 x 70	8	14	60	50	13	25	9	100	75	150	98	448
AACES10	M10 x 80	8	16	70	60	17	50	12	120	90	180	441	709
AACES12	M12 x 115	18	20	90	80	19	85	14	160	120	240	571	1031

AC-GA

Gancho

CÓDIGO	MXL	ABERTURA GANCHO	Ø BROCA	PROFUNDIDAD MÍN. DE TALADRO	PROFUNDIDAD MÍN. DEL ANCLAJE	LLAVE DE INSTALACIÓN	PAR DE APRIETE (NM)	Ø ELEMENTO A FIJAR	MÍN. ESPESOR MATERIAL BASE	DISTANCIA MÍN. AL BORDE "A"	DISTANCIA MÍN. ENTRE EJES "B"	EXTRACCIÓN HORMIGÓN NO-FISURADO	CIZALLADURA HORMIGÓN NO-FISURADO
AACGA06	M6 x 55	10	10	45	40	10	10	7	100	60	120	80	-
AACGA08	M8 x 60	11	14	60	50	13	25	9	100	75	150	98	-
AACGA10	M10 x 73	14	16	70	60	17	50	12	120	90	180	243	-
AACGA12	M12 x 90	18	20	90	80	19	85	14	160	120	240	396	-

AC-AR

Argolla

CÓDIGO	MXL	Ø OJO	Ø BROCA	PROFUNDIDAD MÍN. DE TALADRO	PROFUNDIDAD MÍN. DEL ANCLAJE	LLAVE DE INSTALACIÓN	PAR DE APRIETE (NM)	Ø ELEMENTO A FIJAR	MÍN. ESPESOR MATERIAL BASE	DISTANCIA MÍN. AL BORDE "A"	DISTANCIA MÍN. ENTRE EJES "B"	EXTRACCIÓN HORMIGÓN NO-FISURADO	CIZALLADURA HORMIGÓN NO-FISURADO
AACAR06	M6 x 55	10	10	45	40	10	10	7	100	60	120	92	-
AACAR08	M8 x 60	12	14	60	50	13	25	9	100	75	150	98	-
AACAR10	M10 x 73	14	16	70	60	17	50	12	120	90	180	441	-
AACAR12	M12 x 90	17	20	90	80	19	85	14	160	120	240	571	-

HI

Anclaje antigiro para cargas altas

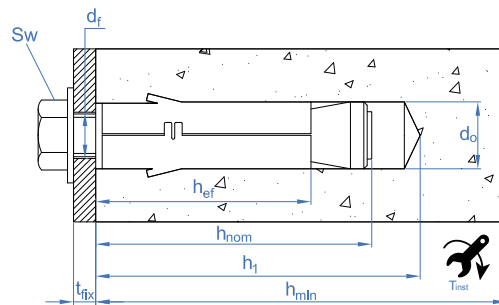

HI-CA

Cápsula

CÓDIGO	MXL	ESPEJOR MÁX. A FIJAR	Ø BROCA	PROFUNDIDAD MÍN. DE TALADRO	PROFUNDIDAD MÍN. DEL ANCLAJE	PAR DE APRIETE (NM)	Ø ELEMENTO A FIJAR	MÍN. ESPESOR MATERIAL BASE	DISTANCIA MÍN. AL BORDE "A"	DISTANCIA MÍN. ENTRE EJES "B"	EXTRACCIÓN HORMIGÓN NO-FISURADO	CIZALLADURA HORMIGÓN NO-FISURADO
AHICA0645	M6 x 45	-	12	60	45	10	7	100	45	90	41	392
AHICA0855	M8 x 55	-	14	65	50	20	9	100	55	105	163	494
AHICA1065	M10 x 65	-	16	75	60	40	12	100	70	135	237	721
AHICA1275	M12 x 75	-	20	90	70	65	14	110	85	165	332	1841
AHICA1690	M16 x 90	-	24	105	100	150	18	140	105	210	424	2797

HI-CI

Cápsula. Inoxidable A2

CÓDIGO	MXL	ESPEJOR MÁX. A FIJAR	Ø BROCA	PROFUNDIDAD MÍN. DE TALADRO	PROFUNDIDAD MÍN. DEL ANCLAJE	PAR DE APRIETE (NM)	Ø ELEMENTO A FIJAR	MÍN. ESPESOR MATERIAL BASE	DISTANCIA MÍN. AL BORDE "A"	DISTANCIA MÍN. ENTRE EJES "B"	EXTRACCIÓN HORMIGÓN NO-FISURADO	CIZALLADURA HORMIGÓN NO-FISURADO
AHICIO645	M6 x 60	-	12	60	45	10	7	100	45	90	360	329
AHICIO855	M8 x 65	-	14	65	50	20	9	100	55	105	542	600
AHICIO65	M10 x 81	-	16	75	60	40	12	100	70	135	704	844

HI-TO Tornillo 8.8													
CÓDIGO	MXL	ESPESOR MÁX. A FIJAR	Ø BROCA	PROFUNDIDAD MÍN. DE TALADRO	PROFUNDIDAD MÍN. DEL ANCLAJE	LLAVE DE INSTALACIÓN	PAR DE APRIETE (NM)	Ø ELEMENTO A FIJAR	MÍN. ESPESOR MATERIAL BASE	DISTANCIA MÍN. AL BORDE "A"	DISTANCIA MÍN. ENTRE EJES "B"	EXTRACCIÓN HORMIGÓN NO-FISURADO	CIZALLADURA HORMIGÓN NO-FISURADO
AHITO0645	M6 x 50	8	12	60	45	10	10	7	100	45	90	41	392
AHITO0855	M8 x 60	15	14	65	50	13	20	9	100	55	105	163	494
AHITO1065	M10 x 80	23	16	75	60	17	40	12	100	70	135	237	721
AHITO1275	M12 x 100	30	20	90	70	19	65	14	110	85	165	332	1841
AHITO1690	M16 x 110	17	24	105	100	24	150	18	140	105	210	424	2797

HI-GA Gancho													
CÓDIGO	MXL	ABERTURA GANCHO	Ø BROCA	PROFUNDIDAD MÍN. DE TALADRO	PROFUNDIDAD MÍN. DEL ANCLAJE	LLAVE DE INSTALACIÓN	PAR DE APRIETE (NM)	MÍN. ESPESOR MATERIAL BASE	DISTANCIA MÍN. AL BORDE "A"	DISTANCIA MÍN. ENTRE EJES "B"	EXTRACCIÓN HORMIGÓN NO-FISURADO	CIZALLADURA HORMIGÓN NO-FISURADO	
AHIGA0645	M6 x 55	10	12	60	45	10	10	100	45	90	41	-	
AHIGA0855	M8 x 60	11	14	65	50	13	20	100	55	105	155	-	
AHIGA1065	M10 x 73	14	16	75	60	17	40	100	70	135	237	-	
AHIGA1275	M12 x 90	18	20	90	70	19	65	110	85	165	332	-	
AHIGA1690	M16 x 110	19	24	105	100	24	150	140	105	210	424	-	

HI-AR Argolla													
CÓDIGO	MXL	Ø OJO	Ø BROCA	PROFUNDIDAD MÍN. DE TALADRO	PROFUNDIDAD MÍN. DEL ANCLAJE	LLAVE DE INSTALACIÓN	PAR DE APRIETE (NM)	MÍN. ESPESOR MATERIAL BASE	DISTANCIA MÍN. AL BORDE "A"	DISTANCIA MÍN. ENTRE EJES "B"	EXTRACCIÓN HORMIGÓN NO-FISURADO	CIZALLADURA HORMIGÓN NO-FISURADO	
AHIAR0645	M6 x 60	10	12	60	45	10	10	100	45	90	41	-	
AHIAR0855	M8 x 65	12	14	65	50	13	20	100	55	105	163	-	
AHIAR1065	M10 x 81	14	16	75	60	17	40	100	70	135	237	-	
AHIAR1275	M12 x 98	17	20	90	70	19	65	110	85	165	332	-	
AHIAR1690	M16 x 120	23	24	105	100	24	150	140	105	210	424	-	

EPS Anclaje metálico para fijar marcos de puertas y ventanas

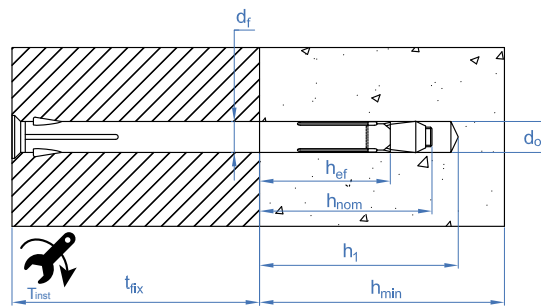

EPS Anclaje metálico para fijar marcos de puertas y ventanas													
CÓDIGO	MXL	ESPESOR MÁX. A FIJAR	Ø BROCA	PROFUNDIDAD MÍN. DE TALADRO	PROFUNDIDAD MÍN. DEL ANCLAJE	PAR DE APRIETE (NM)	Ø ELEMENTO A FIJAR	MÍN. ESPESOR MATERIAL BASE	EXTRACCIÓN HORMIGÓN NO-FISURADO	CIZALLADURA HORMIGÓN FISURADO			
EPS6072	M6 x 72	40	10	60	40	4	10	70	170	-			
EPS6092	M6 x 92	60	10	60	40	4	10	70	170	-			
EPS6112	M6 x 112	80	10	60	40	4	10	70	170	-			
EPS6132	M6 x 132	100	10	60	40	4	10	70	170	-			
EPS6152	M6 x 152	120	10	60	40	4	10	70	170	-			
EPS6182	M6 x 182	150	10	60	40	4	10	70	170	-			

TRA Taco elástico para la fijación de rastreles

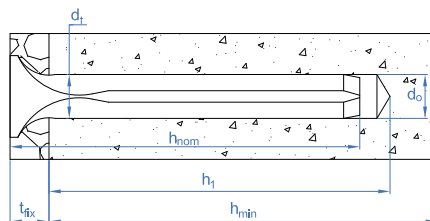

TRA Taco elástico para la fijación de rastreles										
CÓDIGO	MXL	ESPESOR MÁX. A FIJAR	Ø BROCA	PROFUNDIDAD MÍN. DE TALADRO	PROFUNDIDAD MÍN. DEL ANCLAJE	Ø ELEMENTO A FIJAR	MÍN. ESPESOR MATERIAL BASE	EXTRACCIÓN HORMIGÓN NO-FISURADO	CIZALLADURA HORMIGÓN FISURADO	
TRA6050	6 x 50	20	6	40	30	6	35	40	-	
TRA6060	6 x 60	30	6	40	30	6	35	40	-	
TRA6080	6 x 80	50	6	40	30	6	35	40	-	
TRA8070	8 x 70	30	8	50	40	8	45	50	-	
TRA8090	8 x 90	50	8	50	40	8	45	50	-	

TRA8110	8 x 110	70	8	50	40	8	45	50	-
TRA8130	8 x 130	90	8	50	40	8	45	50	-
TRA8150	8 x 150	110	8	50	40	8	45	50	-

ANFA

Anclaje para andamios y fachadas

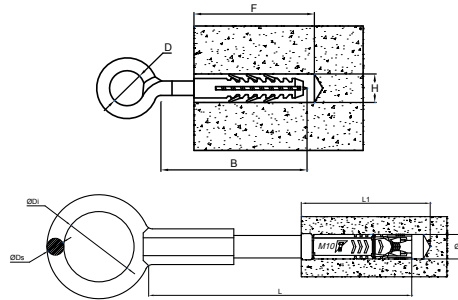

AN-23

Diámetro de ojo 23 mm

CÓDIGO	MXL	Ø BROCA	PROFUNDIDAD MÍN. DE TALADRO	PROFUNDIDAD MÍN. DEL ANCLAJE	MÍN. ESPESOR MATERIAL BASE	Ø OJO	EXTRACCIÓN HORMIGÓN NO-FISURADO
ANFA2309	12 x 90	14 o 16	100	90	130	23	119
ANFA2312	12 x 120	14 o 16	130	120	160	23	119
ANFA2316	12 x 160	14 o 16	170	160	200	23	119
ANFA2319	12 x 190	14 o 16	200	190	230	23	119
ANFA2323	12 x 230	14 o 16	240	230	270	23	119
ANFA2330	12 x 300	14 o 16	310	300	340	23	119
ANFA2335	12 x 350	14 o 16	360	350	390	23	119

AN-51

Diámetro de ojo 51 mm

CÓDIGO	MXL	Ø BROCA	PROFUNDIDAD MÍN. DE TALADRO	PROFUNDIDAD MÍN. DEL ANCLAJE	MÍN. ESPESOR MATERIAL BASE	Ø OJO	EXTRACCIÓN HORMIGÓN NO-FISURADO
ANFA5114	12 x 140	14 o 16	150	140	180	51	119
ANFA5116	12 x 160	14 o 16	170	160	200	51	119
ANFA5120	12 x 200	14 o 16	210	200	240	51	119
ANFA5124	12 x 240	14 o 16	250	240	280	51	119

AN-50 CT

Diámetro de ojo 50 mm + cápsula Zamak M10

CÓDIGO	MXL	PROFUNDIDAD MÍN. DE TALADRO	MÍN. ESPESOR MATERIAL BASE	Ø OJO	EXTRACCIÓN HORMIGÓN NO-FISURADO
ANFAZ5021	M10 x 210	120	160	50	200

CA-QU

Resina de epoxi-acrilato, cuarzo y catalizador.
Homologado ETE Opt. 8

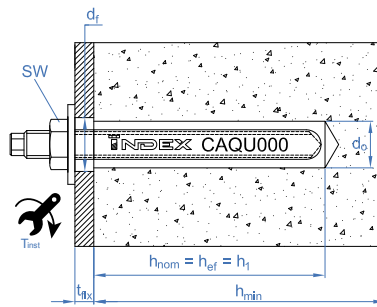

CA-QU

Resina de epoxi-acrilato, cuarzo y catalizador. Homologado ETE Opción 8

CÓDIGO	MXL	ESPEJOR MÁX. A FIJAR	Ø BROCA	PROFUNDIDAD MÍN. DE TALADRO	PROFUNDIDAD MÍN. DEL ANCLAJE	LLAVE DE INSTALACIÓN	PAR DE APRIETE (NM)	Ø ELEMENTO A FIJAR	MÍN. ESPESOR MATERIAL BASE	DISTANCIA MÍN. AL BORDE "A"	DISTANCIA MÍN. ENTRE EJES "B"	EXTRACCIÓN HORMIGÓN NO-FISURADO	CIZALLADURA HORMIGÓN NO-FISURADO
CAQU008	8 Ø9 / 17	17	10	80	80	13	10	9	110	120	240	809	524
CAQU010	10 Ø11 / 25	25	12	90	90	17	20	12	120	90	180	1214	815
CAQU012	12 Ø13 / 32	32	14	110	110	19	40	14	140	110	220	1618	1223
CAQU016	16 Ø17 / 44	44	18	125	125	24	80	18	160	125	250	2023	2272
CAQU020	20 Ø22 / 66	66	25	170	170	30	120	22	220	170	340	3034	3553
CAQU024	24 Ø24 / 62	62	28	210	210	36	180	26	260	210	420	3641	5126
CAQU030	30 Ø33 / 22	22	35	280	280	46	300	33	360	280	560	5461	8496

INSTALACIÓN EN HORMIGÓN

1 TALADRAR

Comprobar que:

- El hormigón esté bien compactado y sin poros significativos.
- El producto sea admisible en taladros secos, húmedos o inundados.
- La temperatura de los cartuchos sea la adecuada (revisar tabla).
- La temperatura del material base sea la adecuada (revisar tabla).

Taladro en posición percusión o martillo.

Taladrar a diámetro y profundidad especificados en la ficha de cada producto.

2 - 6 SOPLAR Y LIMPIAR

Limpiar el agujero de restos de polvo y fragmentos del taladrado según indicaciones del gráfico. Utilizar la bomba de aire y el cepillo. En caso de que el producto no sea admisible para taladros inundados y el taladro contenga agua en su interior, ésta debe ser eliminada antes de inyectar la resina.

A - B* - C ABRIR CARTUCHO

Roscar la cánula en el cartucho y colocar el conjunto en la pistola de aplicación. Apretar el gatillo hasta conseguir que el mortero salga por la punta de un color gris uniforme, sin irisaciones (indica mezcla incorrecta); desechar las dos primeras emboladas de cada cartucho, que no serán utilizadas para fijaciones. * En los cartuchos de 300 ml cortar el extremo de la bolsa, por detrás de la grapa de cierre. ** Valido solo para cartuchos de 300 y 410 ml. Para MOPURE y MOPUR3 consultar ficha técnica.

7 APLICAR MORTERO

Insertar la cánula hasta el fondo del taladro y aplicar mortero; ir retirando la cánula lentamente, asegurándose de que no quedan burbujas de aire.

Rellenar el taladro hasta $\frac{1}{2}$ a $\frac{3}{4}$ de su profundidad.

En caso de que no se use completamente el cartucho dejar la cánula montada. Cambiarla solo en el caso de que se vaya a utilizar de nuevo transcurrido el tiempo de manipulación, volviendo a desechar las dos primeras emboladas.

8 INSTALAR

Introducir el espárrago a instalar con la mano, roscando ligeramente, hasta el fondo del taladro, asegurándose de que el mortero cubre los filetes de rosca. La introducción del anclaje debe realizarse dentro del tiempo de manipulación. Se debe observar rebose del mortero en la boca del taladro para asegurar que el hueco entre el espárrago y el taladro queda relleno completamente.

9 APLICAR PAR DE APRIETE INSTALAR

Una vez transcurrido el tiempo de curado aplicar el par de apriete, no excediendo el valor indicado en la tabla.

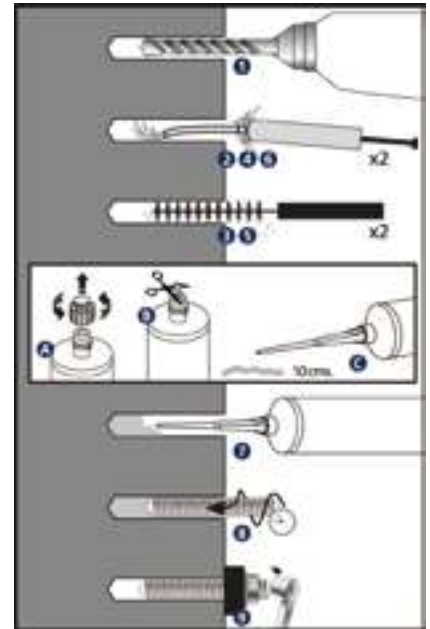

INSTALACIÓN EN LADRILLOS

1 TALADRAR

Comprobar que el ladrillo esté en buen estado y sin poros significativos.

- El producto sea admisible en taladros secos, húmedos o inundados.
- El que la temperatura de los cartuchos sea la adecuada (revisar tabla).
- El que la temperatura del material base sea la adecuada (revisar tabla).

Taladro en posición de rotación.

Taladrar a diámetro y profundidad especificados en la ficha de cada producto

2 - 3 SOPLAR Y LIMPIAR

Limpiar el agujero de restos de polvo y fragmentos del taladrado según indicaciones del gráfico.

Si el taladro tiene agua en su interior ésta debe ser eliminada antes de inyectar la resina.

4 COLOCAR TAMIZ (S)

Insertar el tamiz de plástico o metálico en el taladro de forma que quede rasante con la superficie del material base.

A - B* - C ABRIR CARTUCHO**

Roscar la cánula en el cartucho y colocar el conjunto en la pistola de aplicación. Apretar el gatillo hasta conseguir que el mortero salga por la punta de un color gris uniforme, sin irisaciones (indica mezcla incorrecta); desechar las dos primeras emboladas de cada cartucho, que no serán utilizadas para fijaciones. *En los cartuchos de 170 ml y 300 ml cortar el extremo de la bolsa, por detrás de la grapa de cierre.

** Valido solo para cartuchos de 300 y 410 ml. Para MOPURE y MOPUR3 consultar ficha técnica..

5 APLICAR MORTERO

Insertar la cánula hasta el fondo del tamiz y aplicar mortero; ir retirando la cánula lentamente, asegurándose de que no quedan burbujas de aire. Rellenar el tamiz por completo.

En caso de que no se use completamente el cartucho dejar la cánula montada. Cambiarla solo en el caso de que se vaya a utilizar de nuevo transcurrido el tiempo de manipulación, volviendo a desechar las dos primeras emboladas.

6 INSTALAR

Introducir el espárrago a instalar con la mano, roscando ligeramente, hasta el fondo del taladro, asegurándose de que el mortero cubre los filetes de rosca. La introducción del anclaje debe realizarse dentro del tiempo de manipulación. Se debe observar rebose del mortero en la boca del tamiz para asegurar que el hueco entre el espárrago y el taladro queda relleno completamente.

7 APLICAR PAR DE APRIETE

Una vez transcurrido el tiempo de curado aplicar el par de apriete, no excediendo el valor indicado en la tabla

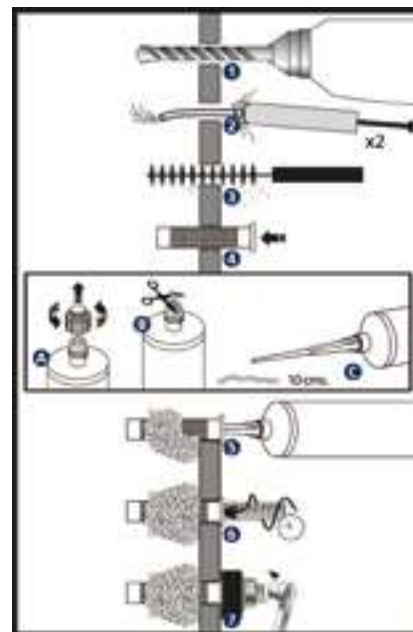

INSTALACIÓN CON TAMIZ PLÁSTICO

MÉTRICA	M8	M10	M12
DIÁMETRO EXTERIOR DEL TAMIZ	15	15	20
LONGITUD DEL AGUJERO	90	90	90
TAMIZ PLÁSTICO	MOTN15085	MOTN15085	MOTN20085

INSTALACIÓN CON TAMIZ ROSCADO

MÉTRICA	M8	M10	M12
DIÁMETRO EXTERIOR DEL TAMIZ	15	20	20
LONGITUD DEL AGUJERO	90	90	90
TAMIZ ROSCADO	MOTRO08	MOTRO10	MOTRO12
TAMIZ PLÁSTICO	MOTN15085	MOTN20085	MOTN20085

TIEMPOS MANIPULACIÓN/CURADO

		0/5	5/10	10/15	15/20	20/25	25,30	30/35	35/40	+40	
Minutos	MO-PU / MO-PUP	MANIPULACIÓN	18	12	6	6	4	3	2	1,5	1,5
		CURADO	120	120	80	80	40	30	20	15	10
	MO-PUS	MANIPULACIÓN	18	10	6	6	4	3	2	1,5	1,5
		CURADO	145	145	85	85	40	35	35	15	10
	MO-P+	MANIPULACIÓN	18	12	6	6	4	3	2	1,5	1,5
		CURADO	120	120	80	80	40	30	20	15	10
	MO-PS+	MANIPULACIÓN	18	10	6	6	5	4	4	--	--
		CURADO	145	145	85	85	40	35	35	--	--
	MO-PSP+	MANIPULACIÓN	18	10	6	6	5	4	4	--	--
		CURADO	145	145	85	85	40	35	35	--	--
	MO-V	MANIPULACIÓN	18	12	6	6	4	3	2	1,5	1,5
		CURADO	120	120	80	80	40	30	20	15	10
	MO-VS	MANIPULACIÓN	18	10	6	6	5	4	4	--	--
		CURADO	145	145	85	85	50	40	35	--	--
	MO-H	MANIPULACIÓN	--	10	8	6	5	4	--	--	--
		CURADO	--	145	85	75	50	40	--	--	--
MO-HW	MANIPULACIÓN	10	5	5	5	100 s	--	--	--	--	
	CURADO	75	50	50	50	20	--	--	--	--	
MOPURE	MANIPULACIÓN	--	20	20	15	11	8	6	4	3	
	CURADO	--	1440	720	480	420	360	300	240	180	
MOPUR3	MANIPULACIÓN	300	150	40	25	18	12	8	6	--	
	CURADO	1440	1440	1080	720	480	360	240	120	--	

T-NUX

Taco de nylon universal de alto rendimiento

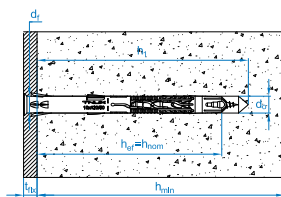

T-NUX A

Cabeza avellanada. Cincado. Homologado ETE

CÓDIGO	MXL	ESPESOR MÁX. A FIJAR	Ø BROCA	PROFUNDIDAD MÍN. DE TALADRO	PROFUNDIDAD MÍN. DEL ANCLAJE	LLAVE DE INSTALACIÓN	Ø ELEMENTO A FIJAR	MÍN. ESPESOR MATERIAL BASE	DISTANCIA MÍN. AL BORDE "A"	DISTANCIA MÍN. ENTRE EJES "B"	EXTRACCIÓN HORMIGÓN NO-FISURADO	CIZALLADURA HORMIGÓN NO-FISURADO
TNUXA08060	8 x 60	10	8	70	50	TX30	8 - 8,5	100	60	100	141	263
TNUXA08080	8 x 80	10	8	90	70	TX30	8 - 8,5	100	60	100	141	263
TNUXA08100	8 x 100	30	8	90	70	TX30	8 - 8,5	100	60	100	141	263
TNUXA08120	8 x 120	50	8	90	70	TX30	8 - 8,5	100	60	100	141	263
TNUXA10060	10 x 60	10	10	70	50	TX40	10 - 11	100	60	100	202	364
TNUXA10080	10 x 80	10	10	90	70	TX40	10 - 11	100	70	100	202	364
TNUXA10100	10 x 100	30	10	90	70	TX40	10 - 11	100	70	100	202	364
TNUXA10120	10 x 120	50	10	90	70	TX40	10 - 11	100	70	100	202	364
TNUXA10140	10 x 140	70	10	90	70	TX40	10 - 11	100	70	100	202	364
TNUXA10160	10 x 160	90	10	90	70	TX40	10 - 11	100	70	100	202	364
TNUXA10180	10 x 180	110	10	90	70	TX40	10 - 11	100	70	100	202	364
TNUXA10200	10 x 200	130	10	90	70	TX40	10 - 11	100	70	100	202	364
TNUXA10230	10 x 230	160	10	90	70	TX40	10 - 11	100	70	100	202	364

T-NUX A A4

Inoxidable A4. Cabeza avellanada. Homologado ETE

CÓDIGO	MXL	ESPEJOR MÁX. A FIJAR	Ø BROCA	PROFUNDIDAD MÍN. DE TALADRO	PROFUNDIDAD MÍN. DEL ANCLAJE	LLAVE DE INSTALACIÓN	Ø ELEMENTO A FIJAR	MÍN. ESPEJOR MATERIAL BASE	DISTANCIA MÍN. AL BORDE "A"	DISTANCIA MÍN. ENTRE EJES "B"	EXTRACCIÓN HORMIGÓN NO-FISURADO	CIZALLADURA HORMIGÓN NO-FISURADO
TNXA408080	8 x 80	10	8	90	70	TX30	8 - 8,5	100	60	100	141	307
TNXA408100	8 x 100	30	8	90	70	TX30	8 - 8,5	100	60	100	141	307
TNXA408120	8 x 120	50	8	90	70	TX30	8 - 8,5	100	60	100	141	307
TNXA410080	10 x 80	10	10	90	70	TX40	10 - 11	100	70	100	202	425
TNXA410100	10 x 100	30	10	90	70	TX40	10 - 11	100	70	100	202	425
TNXA410120	10 x 120	50	10	90	70	TX40	10 - 11	100	70	100	202	425
TNXA410140	10 x 140	70	10	90	70	TX40	10 - 11	100	70	100	202	425

T-NUX E

Cabeza hexagonal. Cincado. Homologado ETE

CÓDIGO	MXL	ESPEJOR MÁX. A FIJAR	Ø BROCA	PROFUNDIDAD MÍN. DE TALADRO	PROFUNDIDAD MÍN. DEL ANCLAJE	LLAVE DE INSTALACIÓN	Ø ELEMENTO A FIJAR	MÍN. ESPEJOR MATERIAL BASE	DISTANCIA MÍN. AL BORDE "A"	DISTANCIA MÍN. ENTRE EJES "B"	EXTRACCIÓN HORMIGÓN NO-FISURADO	CIZALLADURA HORMIGÓN NO-FISURADO
TNUXE08060	8 x 60	10	8	70	50	SW10/TX30	8 - 8,5	100	60	100	141	263
TNUXE08080	8 x 80	10	8	90	70	SW10/TX30	8 - 8,5	100	60	100	141	263
TNUXE08100	8 x 100	30	8	90	70	SW10/TX30	8 - 8,5	100	60	100	141	263
TNUXE08120	8 x 120	50	8	90	70	SW10/TX30	8 - 8,5	100	60	100	141	263
TNUXE10060	10 x 60	10	10	70	50	SW13/TX40	10 - 11	100	70	100	202	364
TNUXE10080	10 x 80	10	10	90	70	SW13/TX40	10 - 11	100	70	100	202	364
TNUXE10100	10 x 100	30	10	90	70	SW13/TX40	10 - 11	100	70	100	202	364
TNUXE10120	10 x 120	50	10	90	70	SW13/TX40	10 - 11	100	70	100	202	364
TNUXE10140	10 x 140	70	10	90	70	SW13/TX40	10 - 11	100	70	100	202	364
TNUXE10160	10 x 160	90	10	90	70	SW13/TX40	10 - 11	100	70	100	202	364
TNUXE10180	10 x 180	110	10	90	70	SW13/TX40	10 - 11	100	70	100	202	364
TNUXE10200	10 x 200	130	10	90	70	SW13/TX40	10 - 11	100	70	100	202	364
TNUXE10230	10 x 230	160	10	90	70	SW13/TX40	10 - 11	100	70	100	202	364

T-NUX E A4

Inoxidable A4. Cabeza hexagonal. Homologado ETE

CÓDIGO	MXL	ESPEJOR MÁX. A FIJAR	Ø BROCA	PROFUNDIDAD MÍN. DE TALADRO	PROFUNDIDAD MÍN. DEL ANCLAJE	LLAVE DE INSTALACIÓN	Ø ELEMENTO A FIJAR	MÍN. ESPEJOR MATERIAL BASE	DISTANCIA MÍN. AL BORDE "A"	DISTANCIA MÍN. ENTRE EJES "B"	EXTRACCIÓN HORMIGÓN NO-FISURADO	CIZALLADURA HORMIGÓN NO-FISURADO
TNXE408080	8 x 80	10	8	90	70	SW10/TX30	8 - 8,5	100	60	100	141	307
TNXE408100	8 x 100	30	8	90	70	SW10/TX30	8 - 8,5	100	60	100	141	307
TNXE410080	10 x 80	10	10	90	70	SW13/TX40	10 - 11	100	70	100	202	425
TNXE410100	10 x 100	30	10	90	70	SW13/TX40	10 - 11	100	70	100	202	425
TNXE410120	10 x 120	50	10	90	70	SW13/TX40	10 - 11	100	70	100	202	425
TNXE410140	10 x 140	70	10	90	70	SW13/TX40	10 - 11	100	70	100	202	425

T-NUX T

Cabeza Truss inviolable. Cincado. Homologado ETE

CÓDIGO	MXL	ESPEJOR MÁX. A FIJAR	Ø BROCA	PROFUNDIDAD MÍN. DE TALADRO	PROFUNDIDAD MÍN. DEL ANCLAJE	LLAVE DE INSTALACIÓN	Ø ELEMENTO A FIJAR	MÍN. ESPEJOR MATERIAL BASE	DISTANCIA MÍN. AL BORDE "A"	DISTANCIA MÍN. ENTRE EJES "B"	EXTRACCIÓN HORMIGÓN NO-FISURADO	CIZALLADURA HORMIGÓN NO-FISURADO
TNUXT10080	10 x 80	10	10	70	50	TX40	10 - 11	100	70	100	202	425
TNUXT10100	10 x 100	30	10	90	70	TX40	10 - 11	100	70	100	202	425
TNUXT10120	10 x 120	50	10	90	70	TX40	10 - 11	100	70	100	202	425
TNUXT10140	10 x 140	70	10	90	70	TX40	10 - 11	100	70	100	202	425
TNUXT10160	10 x 160	90	10	90	70	TX40	10 - 11	100	70	100	202	425

T-FUX E

Taco cabeza cilíndrica. Tornillo cabeza hexagonal. Cincado. Homologado ETE

CÓDIGO	MXL	ESPEJOR MÁX. A FIJAR	Ø BROCA	PROFUNDIDAD MÍN. DE TALADRO	PROFUNDIDAD MÍN. DEL ANCLAJE	LLAVE DE INSTALACIÓN	Ø ELEMENTO A FIJAR	MÍN. ESPEJOR MATERIAL BASE	DISTANCIA MÍN. AL BORDE "A"	DISTANCIA MÍN. ENTRE EJES "B"	EXTRACCIÓN HORMIGÓN NO-FISURADO	CIZALLADURA HORMIGÓN NO-FISURADO
TFUXE10080	10 x 80	10	10	90	70	SW13/TX40	10 - 11	100	70	100	202	425
TFUXE10100	10 x 100	30	10	90	70	SW13/TX40	10 - 11	100	70	100	202	425
TFUXE10120	10 x 120	50	10	90	70	SW13/TX40	10 - 11	100	70	100	202	425
TFUXE10140	10 x 140	70	10	90	70	SW13/TX40	10 - 11	100	70	100	202	425

TCA

Taco clavable poliamida 6.6

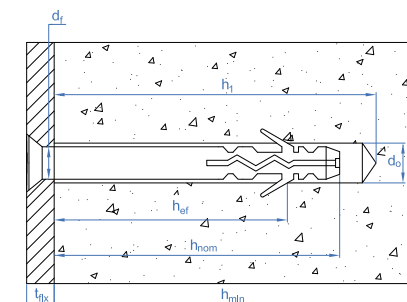

TC-6A

Taco de 6 alas con tornillo avellanado

CÓDIGO	MXL	ESPEJOR MÁX. A FIJAR	Ø BROCA	PROFUNDIDAD MÍN. DE TALADRO	Nº HUELLA	EXTRACCIÓN HORMIGÓN NO-FISURADO	CIZALLADURA HORMIGÓN NO-FISURADO	EXTRACCIÓN LADRILLO MACIZO	EXTRACCIÓN LADRILLO HUECO
TC6A08080	8 x 80	15	8	70	TX30	64	37	37	18
TC6A08100	8 x 100	35	8	70	TX30	64	37	37	18

CÓDIGO	MXL	ESPESOR MÁX. A FIJAR	Ø BROCA	PROFUNDIDAD MÍN. DE TALADRO	Nº HUELLA	EXTRACCIÓN HORMIGÓN NO-FISURADO	CIZALLADURA HORMIGÓN NO-FISURADO	EXTRACCIÓN LADRILLO MACIZO	EXTRACCIÓN LADRILLO HUECO
TC6A08120	8 x 120	55	8	70	TX30	64	37	37	18
TC6A10100	10 x 100	25	10	80	TX40	109	55	53	26
TC6A10120	10 x 120	40	10	80	TX40	109	55	53	26
TC6A10140	10 x 140	60	10	80	TX40	109	55	53	26
TC6A10160	10 x 160	85	10	80	TX40	109	55	53	26
TC6A10200	10 x 200	125	10	80	TX40	109	55	53	26

TC-6E

Taco de 6 alas con tornillo hexagonal

CÓDIGO	MXL	ESPESOR MÁX. A FIJAR	Ø BROCA	PROFUNDIDAD MÍN. DE TALADRO	Nº HUELLA	EXTRACCIÓN HORMIGÓN NO-FISURADO	CIZALLADURA HORMIGÓN NO-FISURADO	EXTRACCIÓN LADRILLO MACIZO	EXTRACCIÓN LADRILLO HUECO
TC6E08080	8 x 80	15	8	70	SW10/TX30	64	37	37	18
TC6E08100	8 x 100	35	8	70	SW10/TX30	64	37	37	18
TC6E08120	8 x 120	55	8	70	SW10/TX30	64	37	37	18
TC6E10100	10 x 100	25	10	80	SW13/TX40	109	55	53	26
TC6E10120	10 x 120	40	10	80	SW13/TX40	109	55	53	26
TC6E10140	10 x 140	60	10	80	SW13/TX40	109	55	53	26
TC6E10160	10 x 160	85	10	80	SW13/TX40	109	55	53	26
TC6E10200	10 x 200	125	10	80	SW13/TX40	109	55	53	26

TC-2A

Taco de 2 alas con tornillo avellanado

CÓDIGO	MXL	ESPESOR MÁX. A FIJAR	Ø BROCA	PROFUNDIDAD MÍN. DE TALADRO	Nº HUELLA	EXTRACCIÓN HORMIGÓN NO-FISURADO	CIZALLADURA HORMIGÓN NO-FISURADO	EXTRACCIÓN LADRILLO MACIZO
TC2A06060	6 x 60	30	6	35	2	34	28	10
TC2A08060	8 x 60	20	8	45	3	34	37	19
TC2A08080	8 x 80	40	8	45	3	40	37	19
TC2A08100	8 x 100	60	8	45	3	40	37	19
TC2A08120	8 x 120	80	8	45	3	40	37	19
TC2A10065	10 x 65	20	10	50	4	45	55	22

CÓDIGO	MXL	ESPESOR MÁX. A FIJAR	Ø BROCA	PROFUNDIDAD MÍN. DE TALADRO	Nº HUELLA	EXTRACCIÓN HORMIGÓN NO-FISURADO	CIZALLADURA HORMIGÓN NO-FISURADO	EXTRACCIÓN LADRILLO MACIZO
TC2A10080	10 x 80	35	10	50	4	45	55	22
TC2A10100	10 x 100	55	10	50	4	45	55	22
TC2A10115	10 x 115	70	10	50	4	45	55	22
TC2A10135	10 x 135	90	10	50	4	45	55	22
TC2A10160	10 x 160	115	10	50	4	45	55	22

TC-SP

Taco clavable de alta expansión

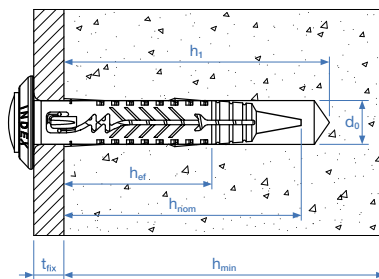

TC-SP

Taco con cabeza avellanada

CÓDIGO	MXL	ESPESOR MÁX. A FIJAR	Ø BROCA	PROFUNDIDAD MÍN. DE TALADRO	Nº HUELLA	EXTRACCIÓN HORMIGÓN NO-FISURADO	EXTRACCIÓN LADRILLO MACIZO
TCSP05027	5 x 27	5	5	25	PZ 2	17	5
TCSP06032	6 x 32	5	6	30	PZ 2	26	7
TCSP06040	6 x 40	10	6	30	PZ 2	26	7

TC

Taco clavable de poliamida 6.6, premontado con tornillo rosca-arpón

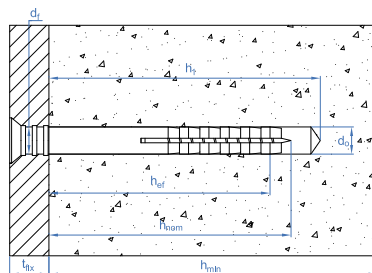

TC-CA

Taco con cabeza avellanada

CÓDIGO	MXL	ESPESOR MÁX. A FIJAR	Ø BROCA	PROFUNDIDAD MÍN. DE TALADRO	Nº HUELLA	EXTRACCIÓN HORMIGÓN NO-FISURADO	CIZALLADURA HORMIGÓN NO-FISURADO	EXTRACCIÓN LADRILLO MACIZO
TCCA05025	5 x 25	5	5	30	PZ2	13	20	3

CÓDIGO	MXL	ESPESOR MÁX. A FIJAR	Ø BROCA	PROFUNDIDAD MÍN. DE TALADRO	Nº HUELLA	EXTRACCIÓN HORMIGÓN NO-FISURADO	CIZALLADURA HORMIGÓN NO-FISURADO	EXTRACCIÓN LADRILLO MACIZO
TCCA05030	5 x 30	5	5	30	PZ2	13	20	3
TCCA05035	5 x 35	10	5	30	PZ2	13	20	3
TCCA05050	5 x 50	25	5	30	PZ2	13	20	3
TCCA06035	6 x 35	10	6	35	PZ2	18	26	4
TCCA06040	6 x 40	10	6	35	PZ2	18	26	4
TCCA06050	6 x 50	20	6	35	PZ2	18	26	4
TCCA06060	6 x 60	30	6	35	PZ2	18	26	4
TCCA06070	6 x 70	40	6	35	PZ2	18	26	4
TCCA06080	6 x 80	50	6	35	PZ2	18	26	4
TCCA08060	8 x 60	20	8	45	PZ3	29	30	7
TCCA08080	8 x 80	40	8	45	PZ3	29	30	7
TCCA08100	8 x 100	60	8	45	PZ3	29	30	7
TCCA08120	8 x 120	80	8	45	PZ3	29	30	7
TCCA08140	8 x 135	100	8	45	PZ3	29	30	7

TC-A2

Taco con cabeza avellanada y tornillo inoxidable A2

CÓDIGO	MXL	ESPESOR MÁX. A FIJAR	Ø BROCA	PROFUNDIDAD MÍN. DE TALADRO	Nº HUELLA	EXTRACCIÓN HORMIGÓN NO-FISURADO	CIZALLADURA HORMIGÓN NO-FISURADO	EXTRACCIÓN LADRILLO MACIZO
TCA205030	5 x 30	5	5	30	PZ2	13	20	3
TCA206040	6 x 40	10	6	35	PZ2	18	26	4
TCA206060	6 x 60	30	6	35	PZ2	18	26	4
TCA208060	8 x 60	20	8	45	PZ3	29	30	7
TCA208080	8 x 80	40	8	45	PZ3	29	30	7
TCA208100	8 x 100	60	8	45	PZ3	29	30	7

TC-CC

Taco con cabeza cilíndrica

CÓDIGO	MXL	ESPESOR MÁX. A FIJAR	Ø BROCA	PROFUNDIDAD MÍN. DE TALADRO	Nº HUELLA	EXTRACCIÓN HORMIGÓN NO-FISURADO	CIZALLADURA HORMIGÓN NO-FISURADO	EXTRACCIÓN LADRILLO MACIZO
TCCC05025	5 x 25	5	5	30	PZ2	13	20	3
TCCC05030	5 x 30	5	5	30	PZ2	13	20	3
TCCC05035	5 x 35	10	5	30	PZ2	13	20	3
TCCC05050	5 x 50	25	5	30	PZ2	13	20	3
TCCC06035	6 x 35	10	6	35	PZ2	18	26	4
TCCC06040	6 x 40	15	6	35	PZ2	18	26	4
TCCC06050	6 x 50	25	6	35	PZ2	18	26	4
TCCC06060	6 x 60	35	6	35	PZ2	18	26	4
TCCC06070	6 x 70	45	6	35	PZ2	18	26	4
TCCC06080	6 x 80	55	6	35	PZ2	18	26	4
TCCC08060	8 x 60	20	8	45	PZ3	18	30	7
TCCC08080	8 x 80	40	8	45	PZ3	29	30	7
TCCC08100	8 x 100	60	8	45	PZ3	29	30	7
TCCC08120	8 x 120	80	8	45	PZ3	29	30	7
TCCC08140	8 x 135	100	8	45	PZ3	29	30	7

AIS

Taco de fijación de paneles aislantes

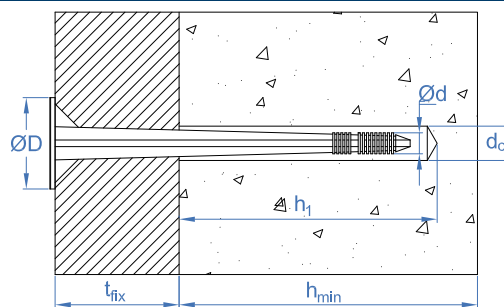

AIS-C

Taco con clavo

CÓDIGO	MXL	MÉTRICA	LONGITUD	Ø BROCA	MÍN. ESPESOR MATERIAL BASE	PROFUNDIDAD MÍN. DE TALADRO	PROFUNDIDAD MÍN. DEL ANCLAJE	ESPESOR MÁX. A FIJAR	DISTANCIA MÍN. AL BORDE "A"	DISTANCIA MÍN. ENTRE EJES "B"	ØD (MM)	EXTRACCIÓN HORMIGÓN NO-FISURADO	EXTRACCIÓN LADRILLO HUECO	EXTRACCIÓN LADRILLO MACIZO	EXTRACCIÓN HORMIGÓN FISURADO
AISC10070	10 x 70	10	70	10	100	60	50	20	100	100	60	29	4	36	29
AISC10090	10 x 90	10	90	10	100	60	50	40	100	100	60	29	4	36	29
AISC10100	10 x 100	10	100	10	100	60	50	50	100	100	60	29	4	36	29
AISC10120	10 x 120	10	120	10	100	60	50	70	100	100	60	29	4	36	29
AISC10140	10 x 140	10	140	10	100	60	50	90	100	100	60	29	4	36	29
AISC10160	10 x 160	10	160	10	100	60	50	110	100	100	60	29	4	36	29
AISC10180	10 x 180	10	180	10	100	60	50	130	100	100	60	29	4	36	29
AISC10200	10 x 200	10	200	10	100	60	50	150	100	100	60	29	4	36	29
AISC10220	10 x 220	10	220	10	100	60	50	170	100	100	60	29	4	36	29
AISC10260	10 x 260	10	260	10	100	60	50	210	100	100	60	29	4	36	29

AIS-S

Clavo metálico con tapón plástico

CÓDIGO	MXL	MÉTRICA	LONGITUD	Ø BROCA	MÍN. ESPESOR MATERIAL BASE	PROFUNDIDAD MÍN. DE TALADRO	PROFUNDIDAD MÍN. DEL ANCLAJE	ESPEOR MÁX. A FIJAR	DISTANCIA MÍN. AL BORDE "A"	DISTANCIA MÍN. ENTRE EJES "B"	ØD (MM)	EXTRACCIÓN HORMIGÓN NO-FISURADO	EXTRACCIÓN LADRILLO HUECO	EXTRACCIÓN LADRILLO MACIZO	EXTRACCIÓN HORMIGÓN FISURADO
AISS10070	10 x 70	10	70	10	100	60	50	20	100	100	60	20	4	23	20
AISS10090	10 x 90	10	90	10	100	60	50	40	100	100	60	20	4	23	20
AISS10100	10 x 100	10	100	10	100	60	50	50	100	100	60	20	4	23	20
AISS10120	10 x 120	10	120	10	100	60	50	70	100	100	60	20	4	23	20
AISS10140	10 x 140	10	140	10	100	60	50	90	100	100	60	20	4	23	20
AISS10160	10 x 160	10	160	10	100	60	50	110	100	100	60	20	4	23	20
AISS10180	10 x 180	10	180	10	100	60	50	130	100	100	60	20	4	23	20
AISS10200	10 x 200	10	200	10	100	60	50	150	100	100	60	20	4	23	20
AISS10220	10 x 220	10	220	10	100	60	50	170	100	100	60	20	4	23	20
AISS10260	10 x 260	10	260	10	100	60	50	210	100	100	60	20	4	23	20

AIS

Taco

CÓDIGO	MXL	ESPEOR MÁX. A FIJAR	Ø BROCA	PROFUNDIDAD MÍN. DE TALADRO	PROFUNDIDAD MÍN. DEL ANCLAJE	Ø ARANDELA	EXTRACCIÓN HORMIGÓN NO-FISURADO
AIS08080	8 x 80	50	8	30	30	35	1
AIS08100	8 x 100	70	8	30	30	35	1
AIS08120	8 x 120	80	8	30	30	35	1
AIS08140	8 x 140	100	8	30	30	35	1

AIS-R

Rosetón

CÓDIGO	MXL	ØD (MM)	D
AISR140	Ø140	140	11

AIS-W

Rosetón para uso con tornillo

CÓDIGO	MXL	ØD (MM)	D
AISW060	Ø60	60	6

AIS-M

Taco metálico

CÓDIGO	MXL	MÉTRICA	LONGITUD	Ø BROCA	MÍN. ESPESOR MATERIAL BASE	PROFUNDIDAD MÍN. DE TALADRO	PROFUNDIDAD MÍN. DEL ANCLAJE	ESPEOR MÁX. A FIJAR	DISTANCIA MÍN. AL BORDE "A"	DISTANCIA MÍN. ENTRE EJES "B"	ØD (MM)
AISM08090	8 x 90	8	90	8	100	50	40	50	100	100	35
AISM08110	8 x 110	8	110	8	100	50	40	70	100	100	35
AISM08120	8 x 120	8	120	8	100	50	40	80	100	100	35
AISM08140	8 x 140	8	140	8	100	50	40	100	100	100	35
AISM08170	8 x 170	8	170	8	100	50	40	130	100	100	35
AISM08200	8 x 200	8	200	8	100	50	40	160	100	100	35
AISM08250	8 x 250	8	250	8	100	50	40	210	100	100	35
AISM08300	8 x 300	8	300	8	100	50	40	260	100	100	35

AIS-AM

Arandela para taco metálico

CÓDIGO	MXL	ØD (MM)	L1	D
AISAM085	Ø85	85	0,5	9

TE

Anclaje espiral

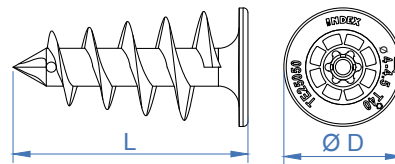

TE

CÓDIGO	MXL	LONGITUD	ØD (MM)
TE25050	25 x 50	50	25
TE25090	25 x 90	90	25

TN4S

Taco de nylon anudable de 4 segmentos para todo tipo de materiales

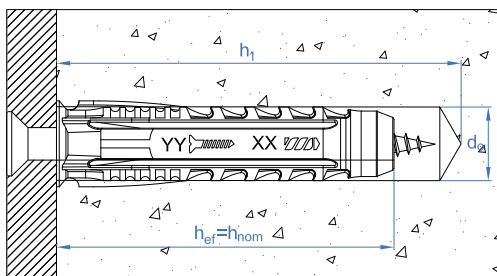

TN4S

Taco

CÓDIGO	MXL	Ø BROCA	PROFUNDIDAD MÍN. DE TALADRO	PROFUNDIDAD MÍN. DEL ANCLAJE	MÍN. ESPESOR MATERIAL BASE	EXTRACCIÓN HORMIGÓN NO-FISURADO	EXTRACCIÓN LADRILLO MACIZO	EXTRACCIÓN LADRILLO HUECO	MEDIDA TORNILLO
TN4S05	5 x 25	5	30	25	35	28	19	13	TPPO 3-4
TN4S06	6 x 30	6	40	30	45	61	48	39	TPPO 4-5
TN4S08	8 x 40	8	50	40	55	170	104	20	TPPO 4,5, TB 5-6
TN4S10	10 x 50	10	60	50	65	256	160	48	TB 6-8
TN4S12	12 x 60	12	70	60	75	394	104	54	TB 8-10
TN4S14	14 x 70	14	80	70	85	628	224	75	TB 10-12

TN4S-L

Taco largo

CÓDIGO	MXL	Ø BROCA	PROFUNDIDAD MÍN. DE TALADRO	PROFUNDIDAD MÍN. DEL ANCLAJE	MÍN. ESPESOR MATERIAL BASE	EXTRACCIÓN HORMIGÓN NO-FISURADO	EXTRACCIÓN LADRILLO MACIZO	EXTRACCIÓN LADRILLO HUECO	MEDIDA TORNILLO
TN4S06L	6 x 45	6	55	45	60	60	35	39	TPPO 4-5
TN4S08L	8 x 60	8	70	60	75	129	68	43	TPPO 4,5, TB 5-6
TN4S10L	10 x 80	10	90	80	95	0	210	46	TB 6-8

TN4S-A

Taco con collarín

CÓDIGO	MXL	Ø BROCA	PROFUNDIDAD MÍN. DE TALADRO	PROFUNDIDAD MÍN. DEL ANCLAJE	MÍN. ESPESOR MATERIAL BASE	EXTRACCIÓN HORMIGÓN NO-FISURADO	EXTRACCIÓN LADRILLO MACIZO	EXTRACCIÓN LADRILLO HUECO	MEDIDA TORNILLO
TN4SA06	6 x 30	6	40	30	45	61	48	39	TPPO 3,5-4

MEDU

Taco universal con collarín y forma de nudo

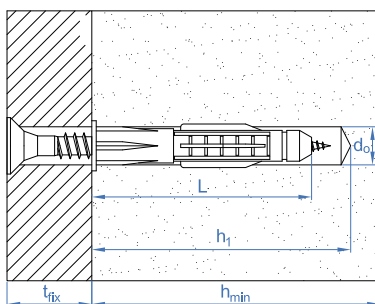

MEDU

Polipropileno

CÓDIGO	MXL	Ø BROCA	PROFUNDIDAD MÍN. DE TALADRO	MÍN. ESPESOR MATERIAL BASE	EXTRACCIÓN HORMIGÓN NO-FISURADO	EXTRACCIÓN LADRILLO MACIZO	EXTRACCIÓN LADRILLO HUECO
MEDUB06	6 x 35	6	45	65	8	5	4
MEDUB07	8 x 42	8	50	70	12	5	4
MEDUB08	8 x 50	8	60	80	24	5	4
MEDUB10	10 x 60	10	75	95	70	7	5

TACON

Taco de nylon

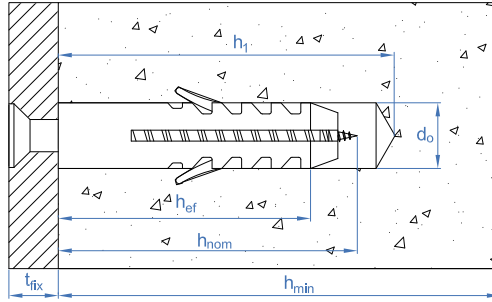

TACON/TACOL/TACOLA

Taco

CÓDIGO	MXL	Ø BROCA	PROFUNDIDAD MÍN. DE TALADRO	PROFUNDIDAD MÍN. DEL ANCLAJE	MÍN. ESPESOR MATERIAL BASE	EXTRACCIÓN HORMIGÓN NO-FISURADO	EXTRACCIÓN LADRILLO MACIZO	MEDIDA TORNILLO
TACON04	4 x 20	4	25	20	30	6	4	TPPO 2,5-3
TACON05/TACOL05/	5 x 25	5	35	25	40	7	5	TPPO 2,5-4
TACON06/TACOL06/TACOLA06	6 x 30	6	40	30	45	10	5	TPPO 3,5-4
TACON07	7 x 30	7	45	30	45	11	6	TPPO 4-4,5
TACON08/TACOL08	8 x 40	8	50	40	55	12	11	TPPO 4,5, TB 5-6
TACON10/TACOL10	10 x 50	10	60	50	70	61	16	TB 6-8
TACON12/TACOL12	12 x 60	12	70	60	80	76	28	TB 8-10
TACON14	14 x 70	14	80	70	95	167	88	TB 10-12
TACON16	16 x 80	16	90	80	100	240	100	TB 12-14

BA-NO

Basculantes por gravedad para la fijación de elementos ligeros en falsos techos

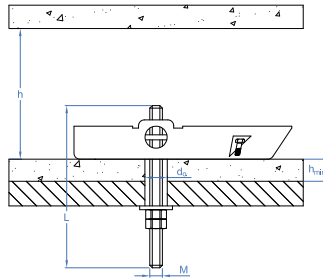

BA-ES

Espiga

CÓDIGO	MXL	MÁX. ESPESOR CONJUNTO MATERIAL BASE Y ELEMENTO A FIJAR \leq	Ø BROCA	CAVIDAD MÍNIMA "H"	EXTRACCIÓN BOVEDILLA DE HORMIGÓN	EXTRACCIÓN CARTÓN YESO	EXTRACCIÓN ESCAYOLA
BAESM04	M4 x 100	74	14	70	10	5	5
BAESM05	M5 x 100	72	14	70	12	5	5
BAESM06	M6 x 100	68	16	75	13	6	6
BAESM08	M8 x 100	60	20	85	14	6	6

BA-GA

Gancho

CÓDIGO	MXL	MÁX. ESPESOR CONJUNTO MATERIAL BASE Y ELEMENTO A FIJAR \leq	Ø BROCA	CAVIDAD MÍNIMA "H"	EXTRACCIÓN BOVEDILLA DE HORMIGÓN	EXTRACCIÓN CARTÓN YESO	EXTRACCIÓN ESCAYOLA
BAGAM04	M4 x 77	74	14	70	10	5	5
BAGAM05	M5 x 80	72	14	70	12	5	5
BAGAM06	M6 x 87	68	16	75	13	6	6
BAGAM08	M8 x 95	60	20	85	14	6	6

BA-NY

Nylon

CÓDIGO	MXL	MÁX. ESPESOR CONJUNTO MATERIAL BASE Y ELEMENTO A FIJAR \leq	Ø BROCA	CAVIDAD MÍNIMA "H"	EXTRACCIÓN BOVEDILLA DE HORMIGÓN	EXTRACCIÓN CARTÓN YESO	EXTRACCIÓN ESCAYOLA
BANYM05	M5 x 157	10	13	55	-	-	-
BANYM06	M6 x 157	10	13	55	-	-	-

PA-LO

Palomilla con muelle

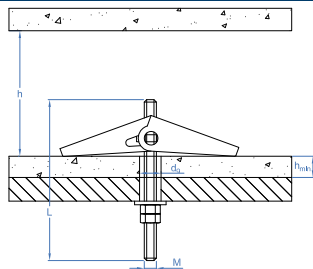

PA-ES

Espiga

CÓDIGO	MXL	MÁX. ESPESOR CONJUNTO MATERIAL BASE Y ELEMENTO A FIJAR s	Ø BROCA	CAVIDAD MINIMA "H"	EXTRACCIÓN BOVEDILLA DE HORMIGÓN	EXTRACCIÓN CARTÓN YESO	EXTRACCIÓN ESCAYOLA
PAESM04	M4 x 100	75	12	26	10	5	5
PAESM05	M5 x 100	70	15	33	12	5	5
PAESM06	M6 x 100	66	18	37	13	6	6
PAESM08	M8 x 100	61	22	54	14	6	6

PA-GA

Gancho

CÓDIGO	MXL	MÁX. ESPESOR CONJUNTO MATERIAL BASE Y ELEMENTO A FIJAR s	Ø BROCA	CAVIDAD MINIMA "H"	EXTRACCIÓN BOVEDILLA DE HORMIGÓN	EXTRACCIÓN CARTÓN YESO	EXTRACCIÓN ESCAYOLA
PAGAM04	M4 x 55	75	12	26	10	5	5
PAGAM05	M5 x 65	70	15	33	12	5	5
PAGAM06	M6 x 80	66	18	37	13	6	6
PAGAM08	M8 x 85	61	22	54	14	6	6

IN

Anclaje Indemoll para fijación en elementos huecos

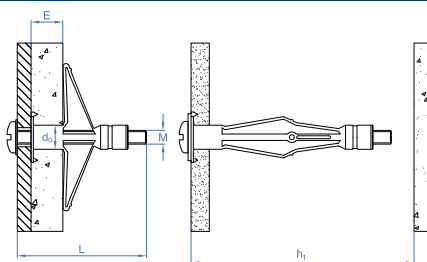

IN-CO

Con tornillo cabeza redonda

CÓDIGO	MXL	Ø BROCA	CAVIDAD MINIMA "H"	MÍN. ESPESOR MATERIAL BASE	ESPESOR MÁX. A FIJAR	EXTRACCIÓN CARTÓN YESO	EXTRACCIÓN ESCAYOLA
INCO421	M4 x 30	8	30	1-5	17 -hmin	20	20
INCO432	M4 x 41	8	41	3-10	22 -hmin	20	20
INCO438	M4 x 47	8	47	9-16	30 -hmin	20	20
INCO446	M4 x 53	8	53	15-22	33 -hmin	20	20
INCO459	M4 x 67	8	67	31-36	52 -hmin	20	20
INCO537	M5 x 46	10	46	5-14	26 -hmin	20	25
INCO552	M5 x 59	10	59	6-18	42 -hmin	20	30
INCO565	M5 x 72	10	72	16-33	55 -hmin	20	30
INCO580	M5 x 89	10	89	33-46	61 -hmin	20	30
INCO637	M6 x 46	12	46	5-13	25 -hmin	15	20
INCO652	M6 x 59	12	59	6-17	38 -hmin	20	25
INCO665	M6 x 72	12	72	14-32	49 -hmin	20	25
INCO680	M6 x 89	12	89	34-46	78 -hmin	20	25

IN-HE

Con tornillo cabeza hexagonal

CÓDIGO	MXL	Ø BROCA	CAVIDAD MINIMA "H"	MÍN. ESPESOR MATERIAL BASE	ESPESOR MÁX. A FIJAR	EXTRACCIÓN CARTÓN YESO	EXTRACCIÓN ESCAYOLA
INHE837	M8 x 45	14	45	5-13	25 -hmin	20	40
INHE855	M8 x 60	14	60	6-18	36 -hmin	20	40
INHE865	M8 x 73	14	73	17-33	47 -hmin	20	40

ANCLA

Taco de nylon para ladrillos huecos y tablarroca

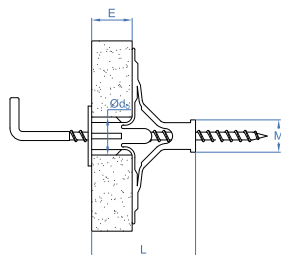

ANCLA

Taco de nylon para ladrillos huecos y placas de cartón yeso

CÓDIGO	MXL	Ø BROCA	MÍN. ESPESOR MATERIAL BASE	EXTRACCIÓN LADRILLO HUECO	EXTRACCIÓN CARTÓN YESO
ANCLA40	10 x 40	10	4-12	10	5
ANCLA47	10 x 47	10	15-19	10	5

TAPLA

Taco para placas de yeso laminado

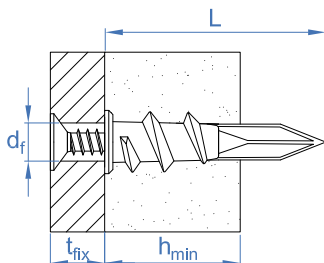

TAPLA NY

Taco de nylon

CÓDIGO	MXL	MÍN. ESPESOR MATERIAL BASE	VÁLIDO PARA	Nº HUELLA	EXTRACCIÓN CARTÓN YESO
TAPLANY	15 x 33	9-16	TPPO 4,5 x 40 / DIN-7981 4,2 x 38	PH3	8

TAPLA ME

Taco de Zamak con tornillo DIN 7981 4,2 x 32

CÓDIGO	MXL	MÍN. ESPESOR MATERIAL BASE	VÁLIDO PARA	Nº HUELLA	EXTRACCIÓN CARTÓN YESO
TAPLAME	13 x 32	9-16	DIN-7981 4,2 x 32	PH2/PH3	8

TAPLA ZK

Taco de Zamak

CÓDIGO	MXL	MÍN. ESPESOR MATERIAL BASE	VÁLIDO PARA	Nº HUELLA	EXTRACCIÓN CARTÓN YESO
TAPLAZK	13 x 37	9-16	TPPO 4,5 x 50 / DIN-7981 4,2 x 38	PZ3	8

AL

Alcayatas

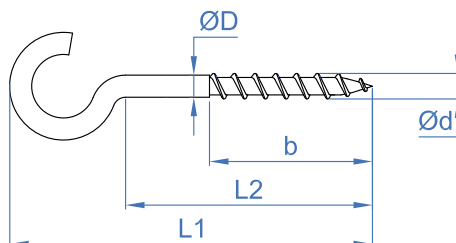

AL-HA

Hembrilla abierta

CÓDIGO	MXL	Ød	L1	B	L2	ØD
ALHA14025	2,6 x 18 x 7	2,6	18	7	10	2,1
ALHA16030	3,1 x 22 x 9	3,1	22	9	12	2,4
ALHA17040	3,5 x 26 x 10	3,5	26	10	14	2,7
ALHA18040	4,1 x 29 x 10	4,1	29	10	15	3,2
ALHA18050	4,1 x 34 x 12	4,1	34	12	20	3,2
ALHA19050	4,4 x 33 x 12	4,4	33	12	18	3,4
ALHA19060	4,4 x 39 x 15	4,4	39	15	22	3,4

ALHA19070	4,4 x 41 x 15	4,4	41	15	24	3,4
ALHA20050	5 x 35 x 12	5	35	12	19	3,9
ALHA20060	5 x 39 x 12	5	39	12	21	3,9
ALHA20070	5 x 44 x 14	5	44	14	26	3,9
ALHA20080	5 x 50 x 18	5	50	18	30	3,9
ALHA21070	5,6 x 43 x 14	5,6	43	14	23	4,4
ALHA21080	5,6 x 48 x 14	5,6	48	14	28	4,4
ALHA21090	5,6 x 56 x 14	5,6	56	14	32	4,4
ALHA21100	5,6 x 61 x 18	5,6	61	18	37	4,4
ALHA22110	6 x 69 x 24	6	69	24	43	4,7
ALHA22120	6 x 74 x 29	6	74	29	48	4,7
ALHA23130	6,3 x 82 x 35	6,3	82	35	55	5,2

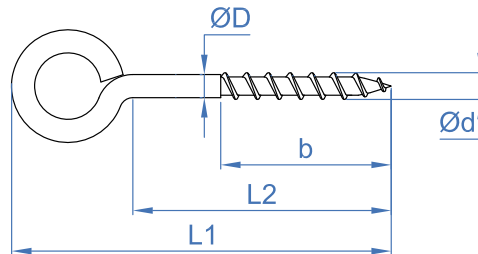

AL-HC

Hembrilla cerrada

CÓDIGO	MXL	Ød	L1	B	L2	ØD
ALHC14025	2,6 x 18 x 7	2,6	18	7	10	2,1
ALHC16030	3,1 x 22 x 9	3,1	22	9	12	2,4
ALHC17040	3,5 x 28 x 10	3,5	28	10	14	2,7
ALHC18040	4,1 x 30 x 10	4,1	30	10	15	3,2
ALHC18050	3,7 x 39 x 12	4,1	39	12	20	3,2
ALHC19050	4,4 x 35 x 12	4,4	35	12	18	3,4
ALHC19060	4,4 x 42 x 15	4,4	42	15	22	3,4
ALHC19070	4,4 x 44 x 15	4,4	44	15	24	3,4
ALHC20050	5 x 39 x 12	5	35	12	19	3,9
ALHC20060	5 x 41 x 12	5	39	12	21	3,9
ALHC20070	5 x 48 x 14	5	43,8	14	26	3,9
ALHC20080	5 x 54 x 18	5	50	18	30	3,9
ALHC21070	5,6 x 49 x 14	5,6	43	14	23	4,4
ALHC21080	5,6 x 54 x 14	5,6	48	14	28	4,4
ALHC21090	5,6 x 61 x 14	5,6	56	14	32	4,4
ALHC21100	5,6 x 66 x 18	5,6	62	18	37	4,4
ALHC22110	6 x 73 x 24	6	69	24	43	4,7
ALHC22120	6 x 81 x 29	6	75	29	48	4,7
ALHC23130	6,3 x 89 x 35	6,3	83	35	55	5,2

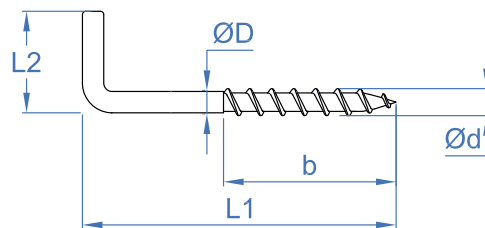

AL-RO

Alcayata roscada de hierro

CÓDIGO	MXL	Ød	L1	L2	B	ØD
ALRO14025	2,6 x 17 x 10	2,6	17	10	10	2
ALRO16030	3,1 x 20 x 10	3,1	20	10	12	2,4
ALRO17040	3,5 x 29 x 13	3,5	29	13	17	2,7
ALRO18040	3,7 x 28 x 14	3,7	28	14	17	2,9
ALRO18050	3,7 x 37 x 15	3,7	37	15	22	2,9
ALRO19050	4,4 x 37 x 15	4,4	37	15	22	3,4
ALRO19060	4,4 x 46 x 17	4,4	46	17	28	3,4
ALRO19070	4,4 x 55 x 18	4,4	55	18	33	3,4
ALRO20060	5 x 44 x 20	5	44	20	26	3,9
ALRO20070	5 x 53 x 20	5	53	20	32	3,9
ALRO20080	5 x 63 x 21	5	63	21	38	3,9
ALRO21080	5,6 x 60 x 22	5,6	60	22	36	4,4
ALRO21090	5,6 x 70 x 22	5,6	70	22	42	4,4
ALRO22100	6 x 79 x 23	6	79	23	47	4,7
ALRO22110	6 x 86 x 23	6	86	23	52	4,7
ALRO22120	6 x 97 x 25	6	97	25	58	4,7
ALRO23130	7,8 x 105 x 25	7,8	105	25	63	5,8

Parámetros punta-broca

			Ø 3.5	Ø 3.9	Ø 4.2	Ø 4.8	Ø 5.5	Ø 6.3
Fuerza máxima instalación		N	150	200	250	250	350	350
Velocidad taladrado	Acero	rpm	1.800 - 2500				1000 - 1800	
	Acero inox	rpm	1.000 - 1500				600 - 1000	
Par máximo		Nm	2.8	3.8	4.7	6.9	10.4	16.9

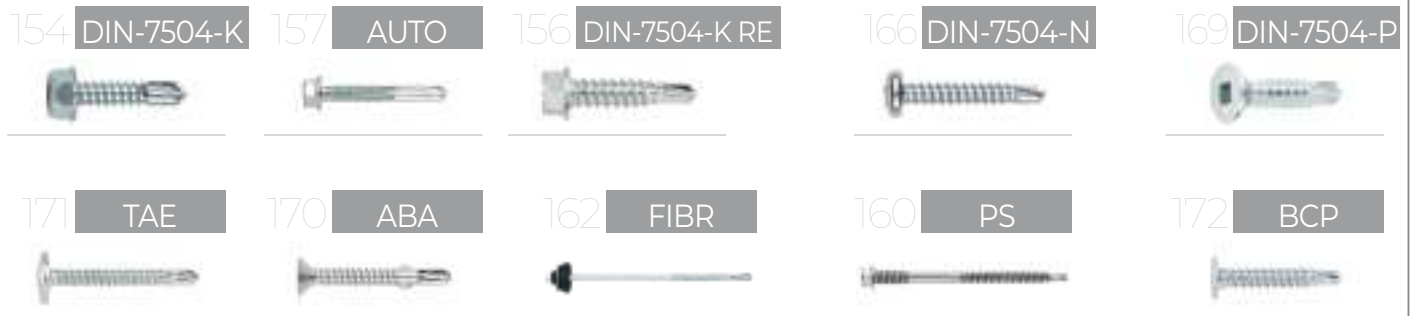

Taladro previo rosca-chapa

Medida	Espesor de chapa	Ø Broca núcleo		Medida	Espesor de chapa	Ø Broca núcleo	
		Aluminio	Acero-latón			Aluminio	Acero-latón
2,9 Nº4	0,4 - 0,6	2,20	2,25	4,8 Nº10	0,4 - 0,6	-	-
	0,6 - 1,0	2,20	2,40		0,6 - 1,0	3,70	3,80
	1,0 - 1,5	2,25	2,40		1,0 - 1,5	3,70	3,80
	1,5 - 2,5	2,40	2,50		1,5 - 2,5	3,80	3,90
	2,5 - 4,0	-	-		2,5 - 4,0	3,80	4,00
3,5 Nº6	0,4 - 0,6	2,70	2,70	5,5 Nº12	0,4 - 0,6	-	-
	0,6 - 1,0	2,70	2,80		0,6 - 1,0	4,30	4,40
	1,0 - 1,5	2,80	2,80		1,0 - 1,5	4,30	4,40
	1,5 - 2,5	2,80	2,90		1,5 - 2,5	4,40	4,50
	2,5 - 4,0	-	3,00		2,5 - 4,0	4,40	4,60
3,9 Nº7	0,4 - 0,6	-	-	6,3 Nº14	0,4 - 0,6	-	-
	0,6 - 1,0	3,00	3,10		0,6 - 1,0	5,00	5,10
	1,0 - 1,5	3,00	3,10		1,0 - 1,5	5,00	5,10
	1,5 - 2,5	3,10	3,20		1,5 - 2,5	5,10	5,20
	2,5 - 4,0	3,10	3,30		2,5 - 4,0	5,10	5,30
4,2 Nº8	0,4 - 0,6	-	-				
	0,6 - 1,0	3,20	3,30				
	1,0 - 1,5	3,20	3,30				
	1,5 - 2,5	3,30	3,40				
	2,5 - 4,0	3,30	3,50				



Tabla de selección de tornillos punta broca

TORNILLO	Ø ROSCA	ESPESOR A TALADRAR EN ACERO [mm]																							
AUTO	5,5	4,0																						12,0	
ABE ABR ABP RS	6,3	2,5																		6,0					
	5,5	1,75												5,25											
	4,8	1,75												4,4											
	4,2	1,75												3,0											
	3,9	0,7	2,4																						
	3,5	0,7	2,25																						
ABA / ATA	6,3	2,5																		6,0					
	5,5	1,75												5,0											
	4,8	1,75												4,0											
TAE	4,2	0,75	2,5																						
BCP	4,2	0,7	2,0																						
ARE	6,3	1,0	1,5																						
	5,5	1,0	1,5																						
	4,8	0,3	1,0																						
PS	5,5	1,5												6,0											
PSL	5,5	6,0												12,0											
		0,00 0,25 0,50 0,75 1,00 1,25 1,50 1,75 2,00 2,25 2,50 2,75 3,00 3,25 3,50 3,75 4,00 4,25 4,50 4,75 5,00 5,25 5,50 5,75 6,00 6,5 7,0 7,5 8,0 8,5 9,0 9,5 10,0 10,5 11,0 11,5 12,0																							
TORNILLO	Ø ROSCA	ESPESOR A TALADRAR EN ALUMINIO [mm]																							
BIE	4,8	1,75												4,4											
	5,5	1,75												5,25											
	6,3	2,5												6,0											
BAUTO	5,5	4,0																						12,0	
		0,00 0,25 0,50 0,75 1,00 1,25 1,50 1,75 2,00 2,25 2,50 2,75 3,00 3,25 3,50 3,75 4,00 4,25 4,50 4,75 5,00 5,25 5,50 5,75 6,00 6,5 7,0 7,5 8,0 8,5 9,0 9,5 10,0 10,5 11,0 11,5 12,0																							

Espesor máximo a fijar

LONGITUD	ST 3,5	ST 3,9	ST 4,2	ST 4,8	ST 5,5	ST 6,3
9,5	2,85					
11	4,2					
13	6,2	5,8	4,3	3,7		
16	9,2	8,8	7,3	5,5		
19	12,1	11,7	10,3	8,7	8,7	7
22	15,1	14,7	13,3	11,7	11,7	10
25	18,1	17,7	16,3	14,7	14,7	13
32	25,1	24,5	23	21,5	21,5	20
38		30,5	29	27,5	27,5	26
45			36	34,5	34,5	33
50			41	39,5	39,5	38
60				49,5	49,5	48
63				52,5	52,5	51
73				62,5	62,5	61
75				64,5	64,5	63
80				69,5		68
90				79,5		78
100				89,5		88
110						98
120						108
130						118
140						128

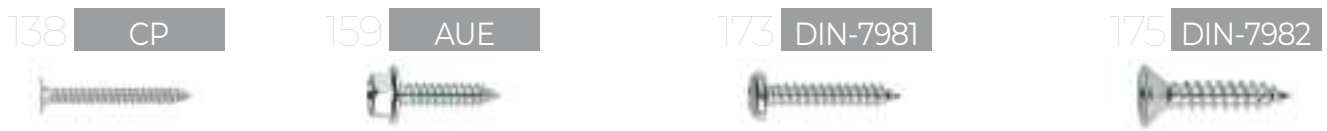
* No válido para tornillo AUTO

AB-IA / AB-RA Abrazadera reforzada M8 abierta



AB-RA / AB-IA Abrazadera reforzada M8 abierta

CÓDIGO	ØD (MM)	ØD (")	A X B	CARGA MÁXIMA
ABIA015 / ABRA015	12 - 16	1/4"	20 x 1,5	80
ABIA018 / ABRA018	15 - 19	3/8"	20 x 1,5	80
ABIA022 / ABRA022	20 - 25	1/2"	20 x 1,5	80
ABIA028 / ABRA028	26 - 30	3/4"	20 x 1,5	80
ABIA035 / ABRA035	32 - 36	1"	20 x 1,5	80
ABIA042 / ABRA042	38 - 43	1 1/4"	20 x 1,5	80
ABIA048 / ABRA048	47 - 51	1 1/2"	20 x 1,5	80
ABIA054 / ABRA054	53 - 58	-	20 x 1,5	80
ABIA060 / ABRA060	60 - 64	2"	20 x 1,5	80
ABIA075 / ABRA075	75 - 80	2 1/2"	20 x 1,5	80
ABIA090 / ABRA090	87 - 92	3"	20 x 1,5	80
ABIA100 / ABRA100	99 - 105	3 1/2"	20 x 1,5	80
ABIA110 / ABRA110	107 - 112	-	20 x 1,5	80
ABIA115 / ABRA115	113 - 118	4"	20 x 1,5	80
ABIA125 / ABRA125	125 - 130	4 1/2"	20 x 1,5	80

AB-IR Abrazadera isofónica M8 instalación rápida

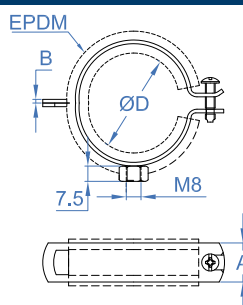

AB-IR Abrazadera isofónica M8 instalación rápida

CÓDIGO	ØD (MM)	ØD (")	A X B	CARGA MÁXIMA
ABIR015	14 - 15	1/4"	19 x 1,25	60
ABIR018	16 - 19	3/8"	19 x 1,25	60
ABIR022	21 - 23	1/2"	19 x 1,25	60
ABIR028	26 - 28	3/4"	19 x 1,25	60
ABIR035	32 - 35	1"	19 x 1,25	60
ABIR040	40 - 43	1 1/4"	19 x 1,25	60
ABIR048	48 - 51	1 1/2"	19 x 1,25	60
ABIR054	52 - 56	-	19 x 1,25	60
ABIR060	57 - 60	2"	19 x 1,25	60

AB-RI / AB-RE

Abrazadera isofónica reforzada M8 + M10

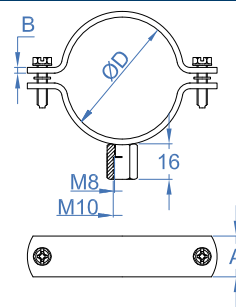
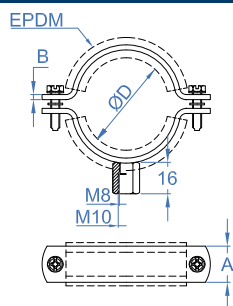

AB-RI / AB-RE

Cincada

CÓDIGO	ØD (MM)	ØD (")	A X B	CARGA MÁXIMA
ABRI018 / ABRE018	15 - 19	3/8"	18,5x1,35	80
ABRI022 / ABRE022	20 - 25	1/2"	18,5x1,35	80
ABRI028 / ABRE028	26 - 30	3/4"	18,5x1,35	80
ABRI035 / ABRE035	32 - 36	1"	18,5x1,35	80
ABRI040 / ABRE040	38 - 43	1 1/4"	18,5x1,35	80
ABRI048 / ABRE048	47 - 51	1 1/2"	18,5x1,35	80
ABRI054 / ABRE054	53 - 56	-	18,5x1,35	80
ABRI060 / ABRE060	60 - 64	2"	18,5x1,35	80
ABRI070 / ABRE070	68 - 72	-	18,5x1,35	80
ABRI075 / ABRE075	75 - 80	2 1/2"	18,5x1,75	150
ABRI083 / ABRE083	81 - 86	-	18,5x1,75	150
ABRI090 / ABRE090	87 - 92	3"	18,5x1,75	150
ABRI100 / ABRE100	99 - 105	3 1/2"	18,5x1,75	150
ABRI110 / ABRE110	107 - 112	-	18,5x1,75	150
ABRI115 / ABRE115	113 - 118	4"	18,5x2,3	200
ABRI125 / ABRE125	125 - 130	4 1/2"	18,5x2,3	200
ABRI133 / ABRE133	132 - 137	-	18,5x2,3	200
ABRI140 / ABRE140	138 - 142	5"	18,5x2,3	200
ABRI150 / ABRE150	148 - 152	-	18,5x2,3	200
ABRI160 / ABRE160	159 - 166	6"	18,5x2,3	200
ABRI180 / ABRE180	179 - 184	-	18,5x2,3	200
ABRI200 / ABRE200	199 - 212	-	18,5x2,3	200
ABRI220 / ABRE220	215 - 226	8"	18,5x2,3	200
ABRI250 / ABRE250	245 - 254	-	18,5x2,3	200
ABRI280 / ABRE280	278 - 284	-	18,5x2,3	200
ABRI300 / ABRE300	299 - 304	-	18,5x2,3	200
ABRI315 / ABRE315	314 - 319	-	18,5x2,3	200
ABRI355 / ABRE355	354 - 359	-	18,5x2,3	200

AB-RI V / AB-RE V

Cincada. Ventilación

CÓDIGO	ØD (MM)	ØD (")	A X B	CARGA MÁXIMA
ABRI250 / ABRE250	245 - 254	-	18,5x2,3	200
ABRI280 / ABRE280	278 - 284	-	18,5x2,3	200
ABRI300 / ABRE300	299 - 304	-	18,5x2,3	200
ABRI315 / ABRE315	314 - 319	-	18,5x2,3	200
ABRI355 / ABRE355	354 - 359	-	18,5x2,3	200
ABRI400 / ABRE400	399 - 404	-	18,5x2,3	200
ABRI450 / ABRE450	449 - 454	-	18,5x2,3	200
ABRI500 / ABRE500	499 - 504	-	18,5x2,3	200
ABRI560 / ABRE560	555 - 561	-	18,5x2,3	200
ABRI600 / ABRE600	599 - 604	-	18,5x2,3	200
ABRI630 / ABRE630	625 - 631	-	18,5x2,3	200
ABRI710 / ABRE710	705 - 711	-	18,5x2,3	200
ABRI800 / ABRE800	799 - 804	-	18,5x2,3	200
ABRI900 / ABRE900	899 - 904	-	18,5x2,3	200
ABRI910 / ABRE910	999 - 1.004	-	18,5x2,3	200
ABRI911 / ABRE911	1.115 - 1.121	-	18,5x2,3	200
ABRI912 / ABRE912	1.245 - 1.251	-	18,5x2,3	200

AB-RI A2 / AB-RI A4 Abrazadera isofónica reforzada M8 + M10



AB-RI A2 / AB-RI A4 Inoxidable A2

CÓDIGO	ØD (MM)	ØD (")	A X B	CARGA MÁXIMA
ABRIA2018 / ABRIA4018	15 - 18	3/8"	18,5X1,7	150
ABRIA2022 / ABRIA4022	20 - 24	1/2"	18,5X1,7	150
ABRIA2028 / ABRIA4028	26 - 30	3/4"	18,5X1,7	150
ABRIA2035 / ABRIA4035	32 - 36	1"	18,5X1,7	150
ABRIA2040 / ABRIA4040	36 - 42	1 1/4"	18,5X1,7	150
ABRIA2048 / ABRIA4048	47 - 50	1 1/2"	18,5X1,7	150
ABRIA2054 / ABRIA4054	51 - 55	-	18,5X1,7	150
ABRIA2060 / ABRIA4060	60 - 64	2"	18,5X1,7	150
ABRIA2075 / ABRIA4075	75 - 80	2 1/2"	18,5X1,7	150
ABRIA2090 / ABRIA4090	87 - 92	3"	18,5X1,7	150
ABRIA2110 / ABRIA4110	106 - 112	-	18,5X1,7	150
ABRIA2115 / ABRIA4115	114 - 119	4"	18,5X1,7	150
ABRIA2125 / ABRIA4125	124 - 131	4 1/2"	18,5X1,7	150
ABRIA2140 / ABRIA4140	133 - 140	5"	18,5X1,7	150
ABRIA2160 / ABRIA4160	159 - 163	6"	18,5X1,7	150

AB-RE A2 / AB-RE A4 Abrazadera reforzada M8 + M10



AB-RE A2 / AB-RE A4 Inoxidable A2

CÓDIGO	ØD (MM)	ØD (")	A X B	CARGA MÁXIMA
ABREA2018 / ABREA4018	15 - 18	3/8"	18,5X1,7	150
ABREA2022 / ABREA4022	20 - 24	1/2"	18,5X1,7	150
ABREA2028 / ABREA4028	26 - 30	3/4"	18,5X1,7	150
ABREA2035 / ABREA4035	32 - 36	1"	18,5X1,7	150
ABREA2040 / ABREA4040	36 - 42	1 1/4"	18,5X1,7	150
ABREA2048 / ABREA4048	47 - 50	1 1/2"	18,5X1,7	150
ABREA2054 / ABREA4054	51 - 55	-	18,5X1,7	150
ABREA2060 / ABREA4060	60 - 64	2"	18,5X1,7	150
ABREA2075 / ABREA4075	75 - 80	2 1/2"	18,5X1,7	150
ABREA2090 / ABREA4090	87 - 92	3"	18,5X1,7	150
ABREA2110 / ABREA4110	106 - 112	-	18,5X1,7	150
ABREA2115 / ABREA4115	114 - 119	4"	18,5X1,7	150
ABREA2125 / ABREA4125	124 - 131	4 1/2"	18,5X1,7	150
ABREA2140 / ABREA4140	133 - 140	5"	18,5X1,7	150
ABREA2160 / ABREA4160	159 - 163	6"	18,5X1,7	150
ABREA2200 / ABREA4200	199 - 212	-	18,5X1,7	150

AB-GA

Abrazadera gásmica M8 + M10 amarilla

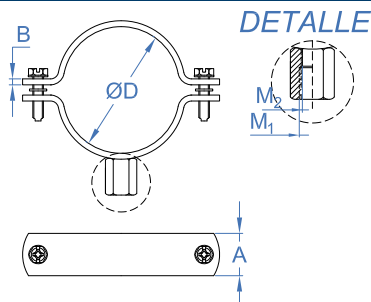

AB-GA

Abrazadera gásmica M8 + M10 amarilla

CÓDIGO	ØD (MM)	ØD (")	A X B	MÉTRICA	CARGA MÁXIMA
ABGA018	15 - 18	3/8"	20 x 2	M8	200
ABGA022	20 - 24	1/2"	20 x 2	M8	200
ABGA028	26 - 30	3/4"	20 x 2	M8	200
ABGA035	32 - 36	1"	20 x 2	M8	200
ABGA040	38 - 42	1 1/4"	20 x 2	M8	200
ABGA048	47 - 50	1 1/2"	20 x 2	M8	200
ABGA054	52 - 56	-	20 x 2	M8	200
ABGA060	60 - 64	2"	20 x 2	M8/M10	200
ABGA075	75 - 80	2 1/2"	20 x 2	M8/M10	200
ABGA090	85 - 90	3"	20 x 2	M8/M10	200
ABGA100	99 - 105	3 1/2"	20 x 2	M8/M10	200
ABGA110	107 - 112	-	20 x 2	M8/M10	200
ABGA115	113 - 118	4"	20 x 2	M8/M10	200
ABGA140	138 - 142	5"	20 x 2	M8/M10	200
ABGA160	159 - 166	6"	20 x 2	M8/M10	200

AB-M8

Abrazadera desagüe M8

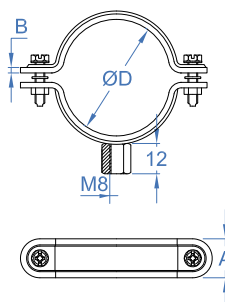

AB-M8

Abrazadera desagüe M8

CÓDIGO	ØD (MM)	ØD (")	A X B	CARGA MÁXIMA
ABM8050	49 - 54	-	28 x 0,8	100
ABM8063	60 - 65	-	28 x 0,8	100
ABM8075	75 - 80	-	28 x 0,8	100
ABM8090	88 - 92	-	28 x 0,8	100
ABM8110	108 - 113	-	28 x 0,8	100
ABM8125	124 - 130	-	28 x 0,8	100
ABM8160	159 - 165	-	28 x 0,8	100
ABM8200	199 - 203	-	28 x 0,8	100
ABM8250	249 - 254	-	28 x 0,8	100
ABM8315	314 - 319	-	28 x 0,8	100

AB-ZI

Abarcón

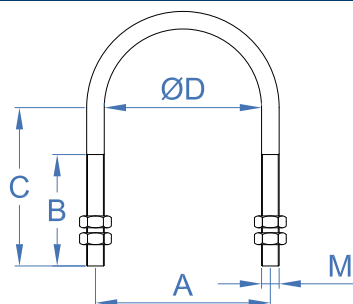

AB-ZI

Cincada

CÓDIGO	ØD (")	MÉTRICA	AXBXC	CARGA MÁXIMA
AZIM060250	1/4"	M6	20 / 14 / 20	250
AZIM060375	3/8"	M6	23,5 / 15 / 23	250
AZIM060500	1/2"	M6	27,5 / 17 / 25	250
AZIM060750	3/4"	M6	33 / 19 / 31	250
AZIM061000	1"	M6	39,5 / 24 / 39	250
AZIM061250	1 1/4"	M6	48,5 / 24 / 44	250
AZIM081500	1 1/2"	M8	56,5 / 26 / 48	350
AZIM082000	2"	M8	68,5 / 26 / 53	350
AZIM082250	2 1/4"	M8	83 / 35 / 63	350
AZIM082500	2 1/2"	M8	83 / 35 / 71	350
AZIM083000	3"	M8	99 / 35 / 76	350
AZIM083500	3 1/2"	M8	112 / 35 / 82	350
AZIM084000	4"	M8	125 / 35 / 87	350
AZIM084500	4 1/2"	M8	140 / 40 / 100	350
AZIM085000	5"	M8	152 / 40 / 105	350
AZIM086000	6"	M8	179 / 40 / 118	350
AZIM103000	3"	M10	100 / 45 / 66	350
AZIM103500	3 1/2"	M10	110 / 50 / 94	350
AZIM104000	4"	M10	125 / 55 / 97,5	350
AZIM105000	5"	M10	150 / 55 / 108	350
AZIM106000	6"	M10	170 / 55 / 125	350
AZIM108000	8"	M10	230 / 55 / 148	350

AB-SA

Soporte de abarcón

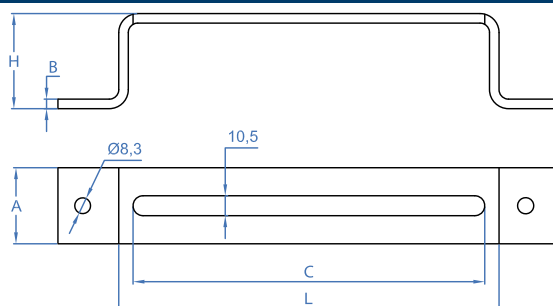

AB-SA

Soporte de abarcón

CÓDIGO	L	H	AXB	C
ABSA050100	100	50	40 x 5	85
ABSA050125	125	50	40 x 5	110
ABSA050200	200	50	40 x 5	185
ABSA050300	300	50	40 x 5	285
ABSA050400	400	50	40 x 5	385
ABSA050500	500	50	40 x 5	485
ABSA050600	600	50	40 x 5	585
ABSA100100	100	100	40 x 5	85
ABSA100125	125	100	40 x 5	110
ABSA100200	200	100	40 x 5	185
ABSA100300	300	100	40 x 5	285
ABSA100400	400	100	40 x 5	385
ABSA100500	500	100	40 x 6	485

AB-GP

Abrazadera de gran presión

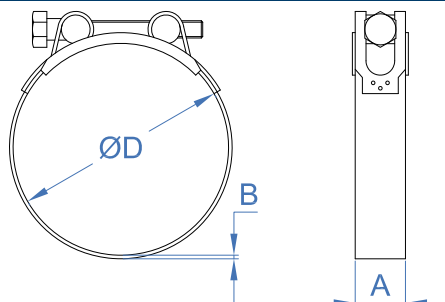

AB-GP

Abrazadera de gran presión

CÓDIGO	M X L	ØD (MM)	A X B
AGP023025	M5 x 35	23 - 25	18 X 0,6
AGP026028	M5 x 35	26 - 28	18 X 0,6
AGP029031	M5 x 35	29 - 31	18 X 0,6
AGP032035	M6 x 50	32 - 35	20 X 1
AGP036039	M6 x 50	36 - 39	20 X 1
AGP040043	M6 x 50	40 - 43	20 X 1
AGP044047	M6 x 50	44 - 47	20 X 1
AGP048051	M6 x 50	48 - 51	20 X 1
AGP052055	M6 x 50	52 - 55	20 X 1
AGP056059	M6 x 55	56 - 59	20 X 1
AGP060063	M6 x 55	60 - 63	20 X 1
AGP064067	M8 x 70	64 - 67	25 X 1,5
AGP068073	M8 x 70	68 - 73	25 X 1,5
AGP074079	M8 x 70	74 - 79	25 X 1,5
AGP080085	M8 x 70	80 - 85	25 X 1,5
AGP086091	M8 x 70	86 - 91	25 X 1,5
AGP092097	M8 x 70	92 - 97	25 X 1,5
AGP098103	M8 x 70	98 - 103	25 X 1,5
AGP104112	M8 x 80	104 - 112	25 X 1,5
AGP113121	M8 x 80	113 - 121	25 X 1,5
AGP122130	M8 x 80	122 - 130	25 X 1,5
AGP131139	M8 x 80	131 - 139	25 X 1,5
AGP140148	M8 x 80	140 - 148	25 X 1,5
AGP149161	M8 x 80	149 - 161	25 X 1,8
AGP162174	M8 x 80	162 - 174	25 X 1,8

AB-M6

Abrazadera M6

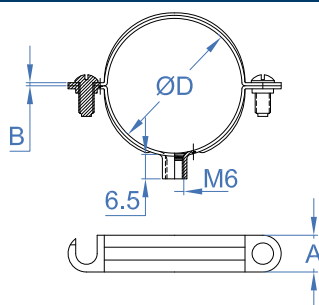

AB-M6 Z / AB-M6 Cincada

CÓDIGO	ØD (MM)	ØD (")	A X B	CARGA MÁXIMA
ABM6008 / ABMZ6008	8	-	10 x 1	70
ABM6010 / ABMZ6010	10	1/8"	10 x 1	70
ABM6012 / ABMZ6012	12	-	10 x 1	70
ABM6014 / ABMZ6014	14	1/4"	10 x 1	70
ABM6015 / ABMZ6015	15	-	10 x 1	70
ABM6016 / ABMZ6016	16	-	10 x 1	70
ABM6018 / ABMZ6018	18	3/8"	10 x 1	70
ABM6020 / ABMZ6020	20	-	10 x 1	70
ABM6022 / ABMZ6022	22	1/2"	10 x 1	70
ABM6025 / ABMZ6025	25	-	10 x 1	70
ABM6026 / ABMZ6026	26	3/4"	10 x 1	70
ABM6028 / ABMZ6028	28	-	10 x 1	70
ABM6032 / ABMZ6032	32	1"	10 x 1	70
ABM6035 / ABMZ6035	35	-	12 x 1,2	70
ABM6037 / ABMZ6037	37	-	12 x 1,2	100

CÓDIGO	ØD (MM)	ØD (")	A X B	CARGA MÁXIMA
ABM6040 / ABMZ6040	40	-	12 x 1,2	100
ABM6040 / ABMZ6040	40	-	12 x 1,2	100
ABM6042 / ABMZ6042	42	1 1/4"	12 x 1,2	100
ABM6047 / ABMZ6047	47	1 1/2"	12 x 1,2	100
ABM6050 / ABMZ6050	50	-	12 x 1,2	100
ABM6054 / ABMZ6054	54	-	12 x 1,2	100
ABM6060 / ABMZ6060	60	2"	12 x 1,2	100
ABM6063 / ABMZ6063	63	-	12 x 1,2	100

AB-D6 Abrazadera doble M6

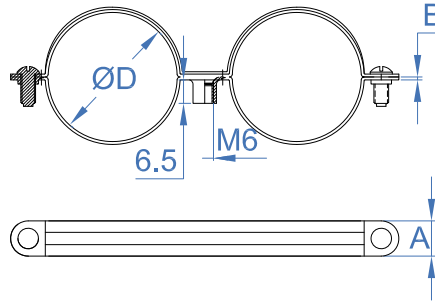

AB-D6 Z / AB-D6 Cincada

CÓDIGO	ØD (MM)	ØD (")	A X B	CARGA MÁXIMA
ABD6012 / ABDZ6012	12	1/8"	12 x 1	100
ABD6015 / ABDZ6015	15	1/4"	12 x 1,2	100
ABD6018 / ABDZ6018	18	3/8"	12 x 1,2	100
ABD6022 / ABDZ6022	22	1/2"	12 x 1,2	100
ABD6028 / ABDZ6028	28	3/4"	12 x 1,2	100

AB-M6 A2 Abrazadera M6

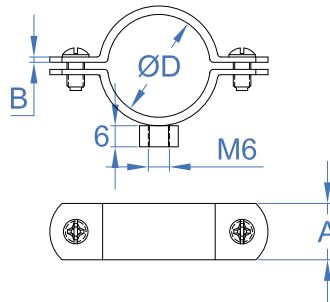

AB-M6 A2 Inoxidable A2

CÓDIGO	ØD (MM)	ØD (")	A X B	CARGA MÁXIMA
ABM6A2012	12	1/4"	16 x 1,5	70
ABM6A2015	14 - 15	-	16 x 1,5	70
ABM6A2018	16 - 18	3/8"	16 x 1,5	70
ABM6A2020	19 - 21	1/2"	16 x 1,5	70
ABM6A2022	22 - 24	-	16 x 1,5	70
ABM6A2028	25 - 30	3/4"	16 x 1,5	70

AB-6I

Abrazadera isofónica M6

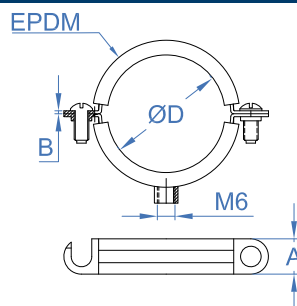

AB-6I

Abrazadera isofónica M6

CÓDIGO	ØD (MM)	ØD (")	A X B	CARGA MÁXIMA
AB6I012	12	1/8"	15 x 1,2	70
AB6I015	15	1/4"	15 x 1,2	70
AB6I016	16	-	15 x 1,2	70
AB6I018	18	3/8"	15 x 1,2	70
AB6I022	22	1/2"	15 x 1,2	70
AB6I026	26	-	15 x 1,2	70
AB6I028	28	3/4"	15 x 1,2	70
AB6I032	32	-	15 x 1,2	70
AB6I035	35	1"	15 x 1,2	70
AB6I042	42	1 1/4"	15 x 1,2	100
AB6I048	48	1 1/2"	15 x 1,2	100
AB6I054	54	-	15 x 1,2	100
AB6I060	60	2"	15 x 1,2	100

AB-DI

Abrazadera doble isofónica M6

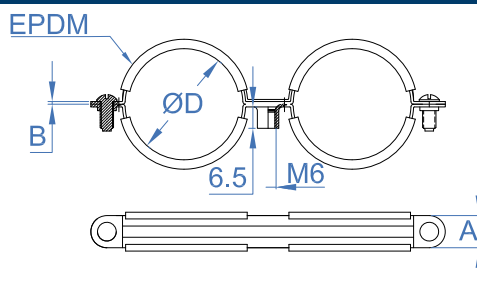

AB-DI

Abrazadera M6. Bicromatada

CÓDIGO	ØD (MM)	ØD (")	A X B	CARGA MÁXIMA
ABDI0012	12	1/8"	15 x 1	100
ABDI0015	15	1/4"	15 x 1,2	100
ABDI0018	18	3/8"	15 x 1,2	100
ABDI0022	22	1/2"	15 x 1,2	100
ABDI0028	28	3/4"	15 x 1,2	100

AB-M7

Abrazadera M7

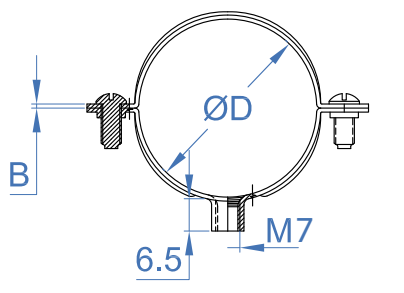

AB-M7 Z

Cincada

CÓDIGO	ØD (MM)	ØD (")	A X B	CARGA MÁXIMA
ABMZ7008	8	-	11 X 1	-
ABMZ7010	10	1/8"	11 X 1	-
ABMZ7012	12	-	11 X 1	-

CÓDIGO	ØD (MM)	ØD (")	A X B	CARGA MÁXIMA
ABMZ7014	14	1/4"	11 X 1	-
ABMZ7016	16	-	11 X 1	-
ABMZ7018	18	3/8"	11 X 1	-
ABMZ7020	20	-	11 X 1	-
ABMZ7022	22	1/2"	11 X 1	-
ABMZ7024	24	-	11 X 1	-
ABMZ7025	25	-	11 X 1	-
ABMZ7026	26	3/4"	11 X 1	-
ABMZ7028	28	-	11 X 1	-
ABMZ7032	32	1"	11 X 1	-
ABMZ7034	34	-	11 X 1	-
ABMZ7036	36	-	11 X 1	-
ABMZ7038	38	-	11 X 1	-
ABMZ7040	40	-	11 X 1	-
ABMZ7050	50	-	11 X 1	-
ABMZ7063	63	-	12 X 1,2	-

AB-D7 Abrazadera doble M7

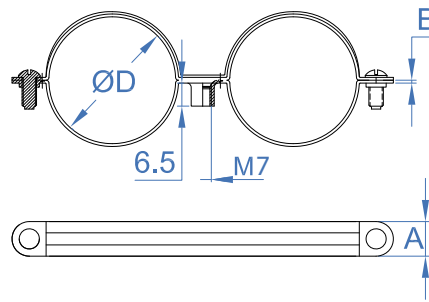

AB-D7 Z Cincada

CÓDIGO	ØD (MM)	ØD (")	A X B	CARGA MÁXIMA
ABDZ70810	8-10	-	11 X 1	-
ABDZ71012	10-12	1/8"	11 X 1	-
ABDZ71214	12-14	-	11 X 1	-
ABDZ71416	14-16	-	11 X 1	-
ABDZ71618	16-18	3/8"	11 X 1	-
ABDZ71820	18-20	-	11 X 1	-
ABDZ72022	20-22	1/2"	11 X 1	-
ABDZ72224	22-24	-	11 X 1	-
ABDZ72628	26-28	3/4"	11 X 1	-

AB-7I Abrazadera isofónica M7

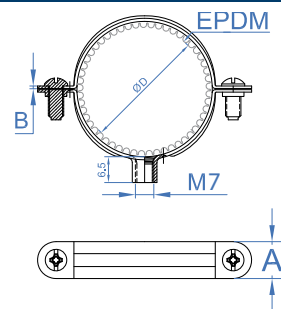

AB-7I Z Abrazadera isofónica M7

CÓDIGO	ØD (MM)	ØD (")	A X B	CARGA MÁXIMA
AB7IZ010	10	-	11 X 1	-
AB7IZ012	12	-	11 X 1	-
AB7IZ014	14	-	11 X 1	-
AB7IZ016	16	-	11 X 1	-
AB7IZ018	18	-	11 X 1	-
AB7IZ020	20	-	11 X 1	-
AB7IZ022	22	-	11 X 1	-
AB7IZ024	24	-	11 X 1	-
AB7IZ026	26	-	11 X 1	-
AB7IZ028	28	-	11 X 1	-
AB7IZ032	32	-	11 X 1	-
AB7IZ034	34	-	11 X 1	-

AB7IZ036	36	-	12 X 1	-
AB7IZ038	38	-	12 X 1	-
AB7IZ040	40	-	12 X 1	-
AB7IZ050	50	-	12 X 1,2	-

AB-7ID

Abrazadera doble isofónica M7

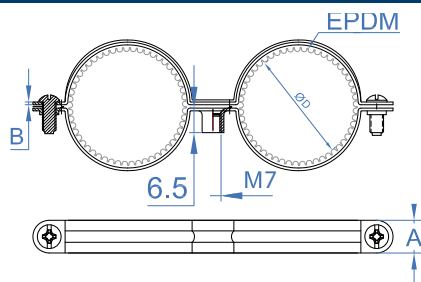

AB-7ID Z

Abrazadera M7. Bicromatada

CÓDIGO	ØD (MM)	ØD (")	A X B	CARGA MÁXIMA
AB7IDZ0810	08-10	1/8"	11 X 1	-
AB7IDZ1012	10-12	1/8"	11 X 1	-
AB7IDZ1214	12-14	1/4"	11 X 1	-
AB7IDZ1416	14-16	1/4"	11 X 1	-
AB7IDZ1618	16-18	3/8"	11 X 1	-
AB7IDZ1820	18-20	3/8"	11 X 1	-
AB7IDZ2022	20-22	1/2"	11 X 1	-
AB7IDZ2224	22-24	1/2"	11 X 1	-
AB7IDZ2628	26-28	3/4"	11 X 1	-

AB-PI

Grapa 1 pie

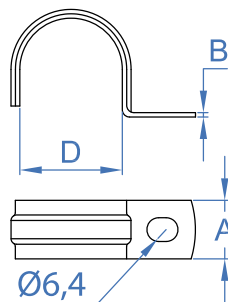

AB-PI

Abrazadera de un pie

CÓDIGO	ØD (MM)	ØD (")	A X B	CARGA MÁXIMA
ABPI006	6	-	12 x 1	30
ABPI008	8	-	12 x 1	30
ABPI010	10	1/8"	12 x 1	30
ABPI012	12	-	12 x 1	30
ABPI014	14	1/4"	15 x 1	30
ABPI016	16	-	15 x 1	30
ABPI018	18	3/8"	15 x 1	30
ABPI020	20	-	15 x 1	30
ABPI022	22	1/2"	15 x 1,2	30
ABPI025	25	-	15 x 1,2	30
ABPI026	26	3/4"	15 x 1,2	30
ABPI028	28	-	15 x 1,2	30
ABPI032	32	1"	15 x 1,2	30
ABPI040	40	-	15 x 1,2	30
ABPI042	42	1 1/4"	15 x 1,2	30
ABPI047	47	1 1/2"	15 x 1,2	30
ABPI050	50	-	15 x 1,2	30
ABPI063	63	2"	15 x 1,2	30

AB-PU

Grapa puente

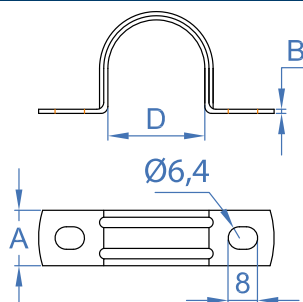

AB-PU

Abrazadera grapa puente

CÓDIGO	ØD (MM)	ØD (")	A X B	CARGA MÁXIMA
ABPU016	16	-	12 x 1,2	75
ABPU018	18	3/8"	12 x 1,2	75
ABPU020	20	-	12 x 1,2	75
ABPU022	22	1/2"	15 x 1,2	75
ABPU025	25	-	15 x 1,2	75
ABPU028	28	3/4"	15 x 1,2	75
ABPU032	32	1"	15 x 1,2	75
ABPU037	37	-	18 x 1,2	75
ABPU040	40	1 1/4"	18 x 1,2	75
ABPU050	50	1 1/2"	18 x 1,2	75
ABPU063	63	2"	18 x 1,2	75

AB-IP

Grapa puente isofónica para montaje

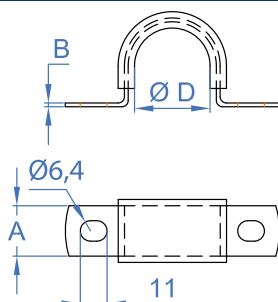

AB-IP

Abrazadera puente isofónica para montaje

CÓDIGO	ØD (MM)	ØD (")	A X B
ABIPO15	15	1/4"	19 X 1,5
ABIPO18	18	3/8"	19 X 1,5
ABIPO22	22	1/2"	19 X 1,5
ABIPO26	26	3/4"	19 X 1,5
ABIPO28	28	-	19 X 1,5
ABIPO35	35	1"	19 X 1,5
ABIPO42	42	1 1/4"	19 X 1,5
ABIPO48	48	1 1/2"	19 X 1,5
ABIPO54	54	-	19 X 1,5
ABIPO60	60	2"	19 X 1,5
ABIPO67	67	-	19 X 1,5
ABIPO75	75	2 1/2"	19 X 1,5
ABIPO90	90	3"	19 X 1,5

AB-SI

Soporte para grapa puente isofónica

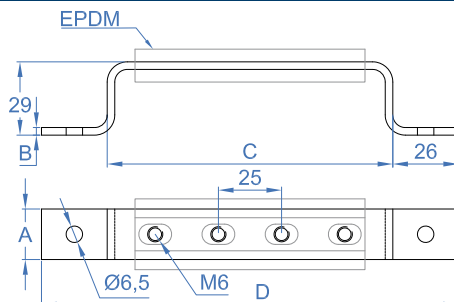

AB-SI

Soporte para grapa puente isofónica

CÓDIGO	AXB	C	D	Nº AGUJEROS
ABSI003	20 x 3	88	140	3
ABSI004	20 x 3	113	165	4
ABSI005	20 x 3	138	190	5
ABSI006	20 x 3	163	215	6
ABSI007	20 x 3	188	240	7
ABSI008	20 x 3	213	265	8
ABSI009	20 x 3	238	290	9
ABSI010	20 x 3	263	315	10
ABSI011	20 x 3	288	340	11
ABSI012	20 x 3	313	365	12
ABSI013	20 x 3	338	390	13
ABSI014	20 x 3	363	415	14
ABSI015	20 x 3	388	440	15
ABSI016	20 x 3	413	465	16
ABSI017	20 x 3	438	490	17
ABSI018	20 x 3	463	515	18
ABSI019	20 x 3	488	540	19
ABSI020	20 x 3	513	565	20
ABSI021	20 x 3	538	590	21
ABSI022	20 x 3	563	615	22
ABSI025	20 x 3	638	690	25

AB-SF

Abrazadera sin fin

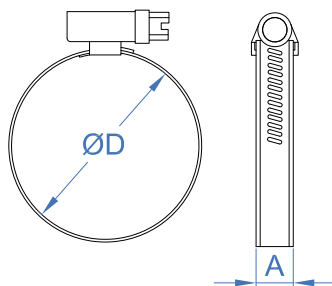

AB-SF

Cincada

CÓDIGO	ØD (MM)	ØD (")	AXB	PAR DE APRIETE
ASF008016	8-16	5/16"- 5/8"	9 x 0,7	4,5
ASF012022	12-22	1/2"- 7/8"	9 x 0,7	4,5
ASF016027	16 - 27	5/8"- 1 1/16"	9 x 0,7	4,5
ASF020032	20 - 32	3/4"- 1 1/4"	9 x 0,7	4,5
ASF025040	25 - 40	1"- 1 5/8"	9 x 0,7	4,5
ASF030045	30 - 45	1 3/16"- 1 3/4"	9 x 0,8	4,5
ASF035050	35 - 50	1 3/8"- 2"	9 x 0,8	4,5
ASF040060	40 - 60	1 5/8"- 2 3/8"	9 x 0,8	4,5
ASF050070	50 - 70	2"- 2 3/4"	9 x 0,8	4,5
ASF060080	60 - 80	2 3/8"- 3 1/8"	9 x 0,8	4,5
ASF070090	70 - 90	2 3/4"- 3 1/2"	9 x 0,8	4,5
ASF080100	80 - 100	3 1/8"- 4"	9 x 0,8	4,5
ASF090110	90 - 110	3 1/2"- 4 3/8"	9 x 0,8	4,5
ASF100120	100 - 120	4"- 4 3/4"	9 x 0,8	4,5
ASF110130	110 - 130	4 3/8"- 5 1/8"	9 x 0,8	4,5
ASF120140	120 - 140	4 3/4"- 5 1/2"	9 x 0,8	4,5
ASF130150	130 - 150	5 1/8"- 5 7/8"	9 x 0,8	4,5

AB-SF A2

Inoxidable A2

CÓDIGO	ØD (MM)	ØD (")	AXB	PAR DE APRIETE
ASF2010016	10-16	5/16" - 5/8"	9 x 0,7	4
ASF2012020	12-20	1/2" - 7/8"	9 x 0,7	4
ASF2016027	16 - 27	5/8" - 1 1/16"	9 x 0,7	4
ASF2020032	20 - 32	3/4" - 1 1/4"	9 x 0,7	4
ASF2025040	25 - 40	1" - 1 5/8"	9 x 0,7	4
ASF2032050	32 - 50	1 3/8" - 2"	9 x 0,7	4
ASF2040060	40 - 60	1 5/8" - 2 3/8"	9 x 0,7	4
ASF2050070	50 - 70	2" - 2 3/4"	9 x 0,7	4
ASF2060080	60 - 80	2 3/8" - 3 1/8"	9 x 0,7	4
ASF2070090	70 - 90	2 3/4" - 3 1/2"	9 x 0,7	4
ASF2080100	80 - 100	3 1/8" - 4"	9 x 0,7	4
ASF2090110	90 - 110	3 1/2" - 4 3/8"	9 x 0,7	4
ASF2100120	100 - 120	4" - 4 3/4"	9 x 0,7	4
ASF2110130	110 - 130	4 3/8" - 5 1/8"	9 x 0,7	4
ASF2120140	120 - 140	4 3/4" - 5 1/2"	9 x 0,7	4
ASF2130150	130 - 150	5 1/8" - 5 7/8"	9 x 0,7	4

CI-PE

Cinta perforada

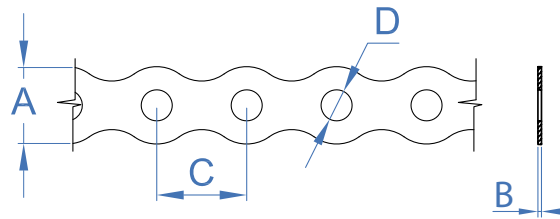

CI-PE

Cinta perforada curva. ATLANTIS C2-M

CÓDIGO	AXB	c	D
CIPE1208	12 x 0,8	14	5
CIPE1708	17 x 0,8	20	7

CI-PE A2

Cinta perforada curva. Inoxidable A2

CÓDIGO	AXB	c	D
CIPEA21708	17 x 0,8	20	7

CI-PR

Cinta perforada recta ATLANTIS C2-M

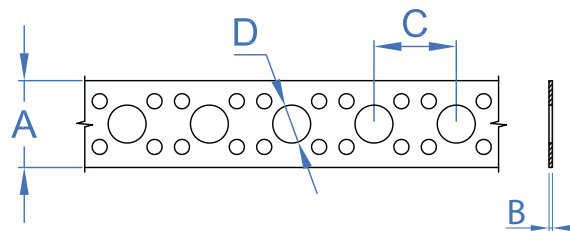

CI-PR

Cinta perforada recta ATLANTIS C2-M

CÓDIGO	AXB	c	D
CIPR1908	19 x 0,8	18	8,3
CIPR1208	12 x 0,8	12	6,2

AB-CR

Abrazadera cromada M6

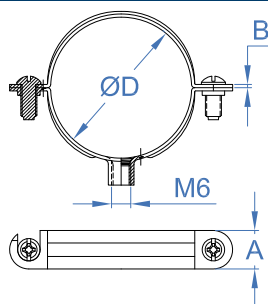

AB-CR

Abrazadera cromada M6

CÓDIGO	ØD (MM)	ØD (")	A X B	CARGA MÁXIMA
ABCR010	10	1/8"	12 x 1,2	70
ABCR012	12	1/4"	12 x 1,2	70

AB-BU

Abrazadera butano

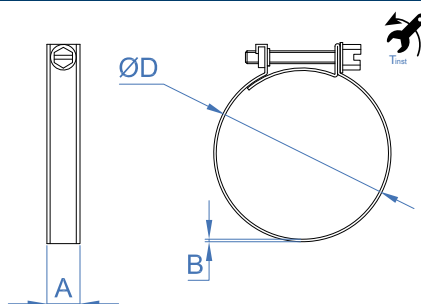

AB-BU

Abrazadera butano

CÓDIGO	ØD (MM)	ØD (")	A X B	PAR DE APRIETE
ABBU1315	13-15	1/2" - 9/16"	9 x 0,6	2
ABBU1618	16-18	5/8" - 11/16"	9 x 0,6	2
ABBU1921	19-21	3/4" - 13/16"	9 x 0,6	2

AB-GM

Abrazadera gásmica con tirafondo amarilla

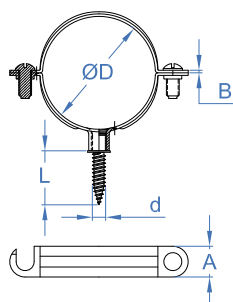

AB-GM

Abrazadera gásmica amarilla M6 con tirafondo

CÓDIGO	ØD (MM)	ØD (")	A X B	CARGA MÁXIMA
ABGM012	12	1/8"	12 x 1,2	70
ABGM015	15	1/4"	12 x 1,2	70
ABGM018	18	3/8"	12 x 1,2	70
ABGM022	22	1/2"	12 x 1,2	70
ABGM028	28	3/4"	12 x 1,2	70
ABGM035	35	1"	12 x 1,2	70

AB-GS

Abrazadera gásmica negra M6 con tirafondo

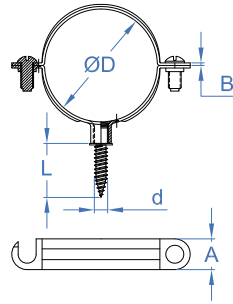

AB-GS

Abrazadera gásmica negra M6 con tirafondo

CÓDIGO	ØD (MM)	ØD (")	A X B	CARGA MÁXIMA
ABGS010	10	1/8"	12 x 1,2	70
ABGS012	12	-	12 x 1,2	70
ABGS015	15	1/4"	12 x 1,2	70
ABGS018	18	3/8"	12 x 1,2	70
ABGS022	22	1/2"	12 x 1,2	70
ABGS028	28	3/4"	12 x 1,2	70
ABGS035	35	1"	12 x 1,2	70
ABGS042	42	1 1/4"	12 x 1,2	70
ABGS054	54	-	12 x 1,2	70

AB-GD

Abrazadera gásmica negra doble M6 con tirafondo

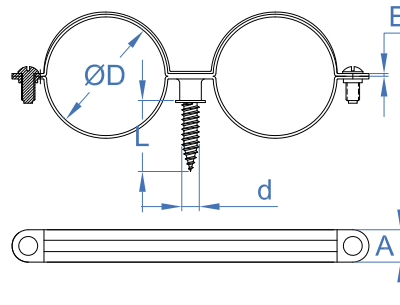

AB-GD

Abrazadera gásmica negra doble M6 con tirafondo

CÓDIGO	ØD (MM)	ØD (")	A X B	CARGA MÁXIMA
ABGD012	12	1/8"	12 x 1,2	100
ABGD015	15	1/4"	12 x 1,2	100
ABGD018	18	3/8"	12 x 1,2	100
ABGD022	22	1/2"	12 x 1,2	100
ABGD028	28	3/4"	12 x 1,2	100

AB-PE

Abrazadera colgante pera

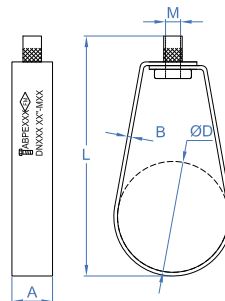

AB-PE

Abrazadera colgante pera

CÓDIGO	ØD (MM)	ØD (")	A X B	LONGITUD	MEDIDA TORNILLO	CARGA MÁXIMA
ABPE028	DN 20	3/4"	21 x 1	72	M10 (3/8")	154
ABPE035	DN 25	1"	21 x 1	78	M10 (3/8")	186
ABPE040	DN 32	1 1/4"	21 x 1	88	M10 (3/8")	195
ABPE048	DN 40	1 1/2"	21 x 1,2	95	M10 (3/8")	236
ABPE060	DN 50	2"	21 x 1,2	105	M10 (3/8")	288
ABPE075	DN 65	2 1/2"	21 x 1,2	125	M10 (3/8")	426

ABPE090	DN 80	3"	21 x 1,2	140	M10 (3/8")	481
ABPE100	DN 90	3 1/2"	21 x 1,2	160	M10 (3/8")	569
ABPE115	DN 100	4"	21 x 2	173	M10 (3/8")	669
ABPE140	DN 125	5"	30 x 2	209	M12 (1/2")	907
ABPE160	DN 150	6"	30 x 2,5	249	M12 (1/2")	1186
ABPE220	DN 200	8"	35 x 2,5	309	M12 (1/2")	1723

AB-CH

Abrazadera desagüe M8

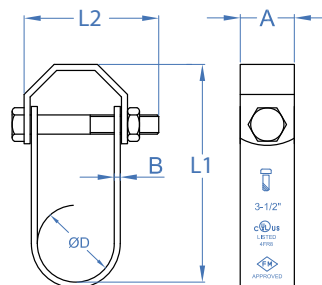

AB-CH

Abrazadera desagüe M8

CÓDIGO	ØD (MM)	ØD (")	A X B	L1	L2	CARGA MÁXIMA
ABCH00034	28	3/4"	22,5 x 2,5	82,5	50	-
ABCH01000	35	1"	22,5 x 2,5	99	57	-
ABCH01014	42	1 1/4"	22,5 x 2,5	106	70	-
ABCH01012	48	1 1/2"	22,5 x 2,5	107	75	-
ABCH02000	60	2"	25,5 x 2,5	126	90	-
ABCH02012	75	2 1/2"	26,0 x 3,0	156	110	-
ABCH03000	90	3"	26,0 x 3,0	169	115	-
ABCH04000	115	4"	30,0 x 4,0	200	15	-
ABCH05000	140	5"	32,0 x 4,5	231	200	-
ABCH06000	160	6"	36,5 x 4,5	260	225	-
ABCH08000	220	8"	42,5 x 4,5	329	280	-
ABCH10000	275	10"	44,5 x 6,0	381	360	-
ABCH12000	325	12"	50,0 x 6,0	457	410	-
ABCH14000	355	14"	50,0 x 6,0	514	465	-
ABCH16000	405	16"	64,0 x 6,0	560	520	-

AB-IN

Clip simple de polipropileno con casquillo de latón M6

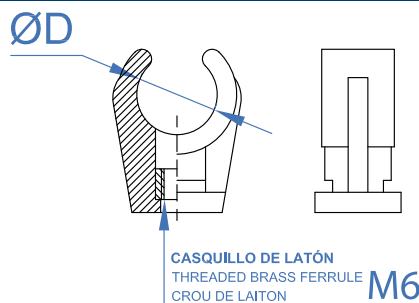

AB-IN

Clip simple de polipropileno con casquillo de latón M6

CÓDIGO	ØD (MM)	ØD (")	VÁLIDO PARA	CARGA MÁXIMA
ABIN012	12	1/4"	Carril 20/10	-
ABIN014	14-15	3/8"	Carril 20/10	-
ABIN016	16-18	-	Carril 20/10	-
ABIN020	20-22	-	Carril 20/10	-
ABIN025	25	-	Carril 20/10	-
ABIN028	28	3/4"	Carril 20/10	-
ABIN032	32	-	Carril 20/10	-
ABIN035	35	-	Carril 20/10	-

AB-ID

Clip doble de polipropileno con casquillo de latón M6

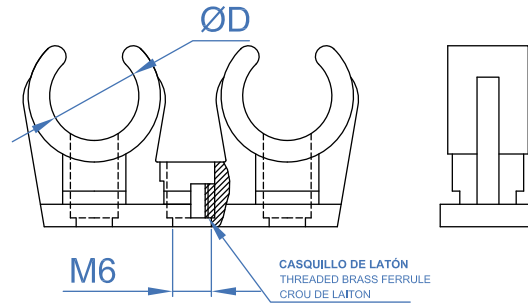

AB-ID

Clip doble de nylon (poliamida 6.6) con casquillo de latón M6

CÓDIGO	ØD (MM)	ØD (")	VÁLIDO PARA	CARGA MÁXIMA
ABID012	12	1/4"	Carril 20/10	-
ABID014	14-15	3/8"	Carril 20/10	-
ABID016	16-18	-	Carril 20/10	-
ABID020	20-22	-	Carril 20/10	-
ABID028	28	3/4"	Carril 20/10	-

AB-GU

Abrazadera guía simple con pre-rosca M6

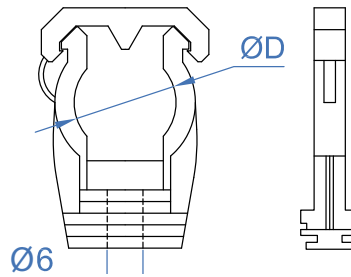

AB-GU

Abrazadera guía gris simple con pre-rosca M6

CÓDIGO	ØD (MM)	ØD (")	VÁLIDO PARA	CARGA MÁXIMA
ABGUG15	15	3/8"	20/10 27/18 28/30	-
ABGUG18	18	-	20/10 27/18 28/30	-
ABGUG20	20	-	20/10 27/18 28/30	-
ABGUG22	22	1/2"	20/10 27/18 28/30	-
ABGUG25	25	-	20/10 27/18 28/30	-
ABGUG28	28	-	20/10 27/18 28/30	-
ABGUG32	32	1"	20/10 27/18 28/30	-
ABGUG40	40	-	20/10 27/18 28/30	-
ABGUG50	50	-	20/10 27/18 28/30	-

AB-MUG

Abrazadera multidiámetro

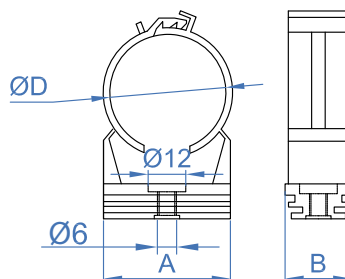

AB-MUG

Abrazadera multiusos

CÓDIGO	ØD (MM)	ØD (")	A X B	VÁLIDO PARA	CARGA MÁXIMA
ABMUG15	15	-	21 x 20	20/10 27/18 28/30	-
ABMUG18	18	-	25 x 20	20/10 27/18 28/30	-
ABMUG22	22	-	30 x 20	20/10 27/18 28/30	-
ABMUG26	26	-	33 x 20	20/10 27/18 28/30	-
ABMUG32	32	-	38 x 20	20/10 27/18 28/30	-
ABMUG40	40	-	46 x 20	20/10 27/18 28/30	-
ABMUG48	42	-	56 x 20	20/10 27/18 28/30	-

AB-PR

Abrazadera a presión con pre-roscas M6

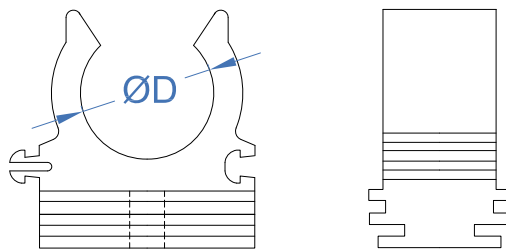

AB-PR

Gris

CÓDIGO	ØD (MM)	ØD (")	VÁLIDO PARA	CARGA MÁXIMA
ABPRG15	15-18	3/8"	20/10 27/18 28/30	-
ABPRG20	20-22	-	20/10 27/18 28/30	-
ABPRG25	25-28	1/2"	20/10 27/18 28/30	-
ABPRG32	32-35	-	20/10 27/18 28/30	-
ABPRG40	40	-	20/10 27/18 28/30	-
ABPRG50	50	3/4"	20/10 27/18 28/30	-

AB-MS

Abrazadera multitubo + taco. Simple

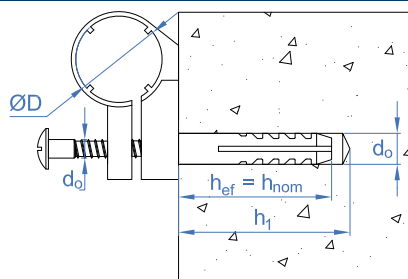

AB-MS

Abrazadera multitubo + taco. Simple

CÓDIGO	ØD (MM)	Ø BROCA	PROFUNDIDAD MÍN. DE TALADRO	PROFUNDIDAD MÍN. DEL ANLAJE	EXTRACCIÓN HORMIGÓN NO-FISURADO	EXTRACCIÓN LADRILLO HUECO	MEDIDA TORNILLO
ABMS10	10	5	30	20	9	5	3,5x35
ABMS12	12	5	30	20	9	5	3,5x35
ABMS14	14	6	35	25	15	8	4x45
ABMS16	16	6	35	25	15	8	4x45
ABMS18	18	8	45	30	16	12	4,5x50
ABMS20	20	8	45	30	16	12	4,5x50
ABMS22	22	8	45	30	16	12	4,5x50
ABMS26	26	10	50	40	30	15	6x60
ABMS28	28	10	50	40	30	15	6,5x60

AB-MD

Abrazadera multitubo + taco. Doble

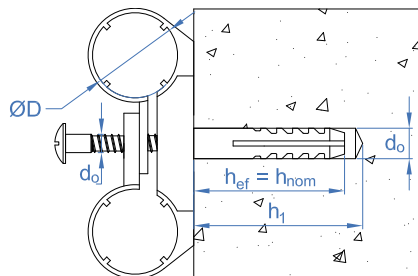

AB-MD

Abrazadera multitubo + taco. Doble

CÓDIGO	ØD (MM)	Ø BROCA	PROFUNDIDAD MÍN. DE TALADRO	PROFUNDIDAD MÍN. DEL ANLAJE	EXTRACCIÓN HORMIGÓN NO-FISURADO	EXTRACCIÓN LADRILLO HUECO	MEDIDA TORNILLO
ABMD10	10	8	60	30	16	12	4,5x50
ABMD12	12	8	60	30	16	12	4,5x50
ABMD14	14	8	60	30	16	12	4,5x50
ABMD16	16	8	60	30	16	12	4,5x50
ABMD18	18	10	70	40	30	15	6x60
ABMD20	20	10	70	40	30	15	6x60
ABMD22	22	10	70	40	30	15	6x60
ABMD26	26	10	70	40	30	15	6x60
ABMD28	28	10	70	40	30	15	6x60

AB-T

Taco para fijación de tubo INDEXring

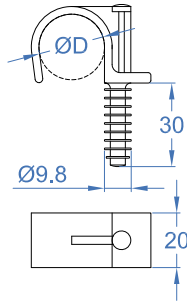

AB-TS

Simple

CÓDIGO	ØD (MM)	ØD (")	CARGA MÁXIMA
ABTS014	14 - 15	-	-
ABTS016	16 - 17	3/8"	-
ABTS018	18 - 19	-	-
ABTS020	20 - 21	1/2"	-
ABTS022	22 - 23	-	-
ABTS025	25 - 26	3/4"	-
ABTS028	28 - 29	-	-
ABTS032	30 - 32	-	-

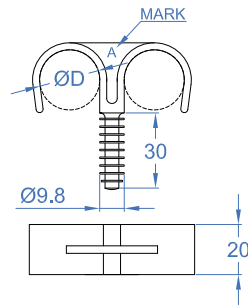

AB-TD

Doble

CÓDIGO	ØD (MM)	ØD (")	CARGA MÁXIMA
ABTD016	15 - 16	3/8"	-
ABTD018	18 - 19	-	-
ABTD020	20 - 21	1/2"	-
ABTD022	22 - 23	-	-
ABTD025	25 - 26	3/4"	-
ABTD028	28 - 29	-	-

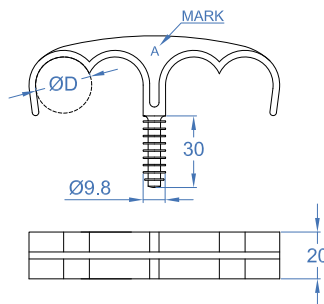

AB-TC

Cuádruple

CÓDIGO	ØD (MM)	ØD (")	CARGA MÁXIMA
ABTC020	20 - 21	1/2"	-
ABTC025	25 - 26	3/4"	-

SU

Sistemas de fijación rápida en viga

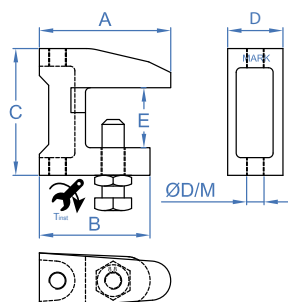

SU-MO

Mordaza para viga

CÓDIGO	A	B	C	D	E	PAR DE APRIETE	LLAVE DE INSTALACIÓN (SW)	ØD (MM)	MEDIDA TORNILLO
SUMOP09	38	35	37	18	20	10	13	PASANTE Ø9	M8 x 35
SUMOP11	44	41	42	21	20	15	17	PASANTE Ø11	M10 x 40
SUMOP13	58	48	54	24	25	15	17	PASANTE Ø13	M10 x 50
SUMOM06	38	35	37	18	20	10	13	ROSCADO M6	M6 x 35
SUMOM08	38	35	37	18	20	10	13	ROSCADO M8	M8 x 35
SUMOM10	44	41	42	21	20	15	17	ROSCADO M10	M10 x 40
SUMOM12	58	48	54	24	25	15	17	ROSCADO M12	M10 x 50

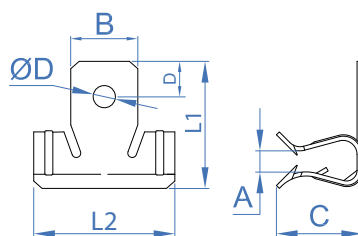

SU-CL

Clip de suspensión

CÓDIGO	A	B	C	D	L1	L2	ØD (MM)
SUCL02	1,5 - 4	13	14	10	28	28	6.3
SUCL04	4 - 10	19	23	10	34	40	6.3
SUCL10	10 - 15	19	23	10	40	40	6.3
SUCL15	15 - 20	19	23	10	40	40	6.3

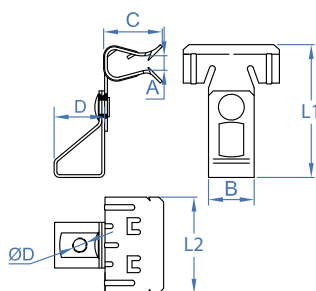

SU-VA

Clip varilla

CÓDIGO	A	B	C	D	L1	L2	ØD (MM)
SUVA0602	1,5 - 4	19	14	21	50	28	M6
SUVA0604	4 - 10	19	23	21	54	40	M6
SUVA0610	10 - 15	19	23	21	60	40	M6
SUVA0615	15 - 20	19	23	21	60	40	M6
SUVA0804	1,5 - 4	19	14	21	50	28	M8
SUVA0810	4 - 10	19	23	21	54	40	M8
SUVA0815	10 - 15	19	23	21	60	40	M8
SUVA0802	15 - 20	19	23	21	60	40	M8

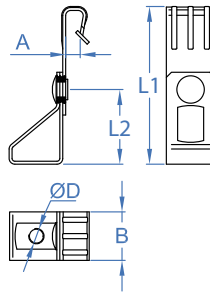

SU-CU Clip de cuelgue

CÓDIGO	A	B	L1	L2	ØD (MM)
SUCU0602	1,5 - 5	19	65	30	M6
SUCU0605	5 - 7	19	65	30	M6
SUCU0606	3 - 7	19	80	30	M6
SUCU0607	7 - 10	19	95	30	M6

SU-AB Clip de viga para abrazadera

CÓDIGO	ESPEJOR MÁX. A FIJAR	ANCHO MÁX. DE VIGA	ØD (MM)	H1	H3	MEDIDA TORNILLO
SUAB0603	3 - 7	36,5	M6	30	36,5	M6x9
SUAB0607	7 - 13	36,5	M6	36	36,5	M6x9
SUAB0614	14 - 20	36,5	M6	43	36,5	M6x9

SU-CA Clip de viga para cable

CÓDIGO	ESPEJOR MÁX. A FIJAR	ØD (MM)	GROSOR
SUCA0602	1 - 4	6-7	0,6
SUCA0604	4 - 7,5	6-7	0,6
SUCA0607	7,5 - 12	6-7	0,6
SUCA0802	1 - 4	8-9	0,6
SUCA0804	4 - 7,5	8-9	0,6
SUCA0807	7,5 - 12	8-9	0,6
SUCA1002	1 - 4	10-11	0,6
SUCA1004	4 - 7,5	10-11	0,6
SUCA1007	7,5 - 12	10-11	0,6
SUCA1202	1 - 4	12-14	0,6
SUCA1204	4 - 7,5	12-14	0,6
SUCA1207	7,5 - 12	12-14	0,6
SUCA1502	1 - 4	15-18	0,6
SUCA1504	4 - 7,5	15-18	0,6
SUCA1507	7,5 - 12	15-18	0,6
SUCA1902	1 - 4	19-24	0,6
SUCA1904	4 - 7,5	19-24	0,6
SUCA1907	7,5 - 12	19-24	0,6
SUCA2502	1 - 4	25-30	0,6
SUCA2504	4 - 7,5	25-30	0,6
SUCA2507	7,5 - 12	25-30	0,6

TAG Tirafondo abrazadera y grapa

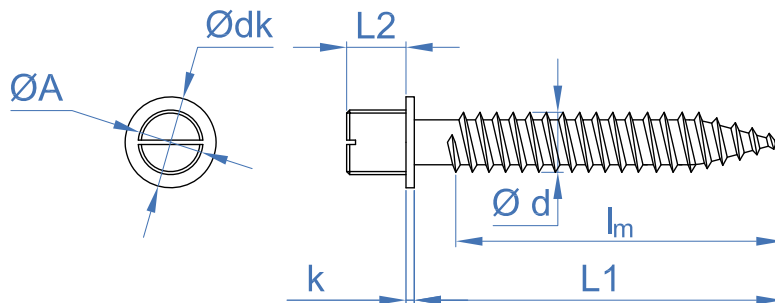

AB-TA Cincado, Ranurado

CÓDIGO	MÉTRICA	ØD	L1	L2	K	ØDK	LONGITUD DE ROSCA
ABTA0630	M6	5	30	6	1	8	30
ABTA0640	M6	5	40	6	1	8	40
ABTA0650	M6	5	50	6	1	8	50
ABTA0730	M7	6	22	6	1	9,5	-
ABTA0740	M7	6	32	6	1	9,5	-
ABTA0750	M7	6	42	6	1	9,5	-

ABTA0760	M7	6	52	6	1	9,5	-
ABTA0770	M7	6	62	6	1	9,5	-
ABTA0780	M7	6	72	6	1	9,5	-
ABTA0840	M8	6	40	7,5	1,4	8,5	40
ABTA0860	M8	6	60	7,5	1,4	8,5	60
ABTA0880	M8	6	80	7,5	1,4	8,5	45
ABTA1050	M10	8	50	9	1,7	12	50
ABTA1070	M10	8	70	9	1,7	12	45
ABTA1090	M10	8	90	9	1,7	12	45

AB-TA B

Bicromatado. Ranurado

CÓDIGO	MÉTRICA	ØD	L1	L2	K	ØDK	LONGITUD DE ROSCA
ABTAB0630	M6	5	30	6	1	8	30
ABTAB0640	M6	5	40	6	1	8	40
ABTAB0650	M6	5	50	6	1	8	50

AB-TA A2

Inoxidable A2. Ranurado

CÓDIGO	MÉTRICA	ØD	L1	L2	K	ØDK	LONGITUD DE ROSCA
ABTA20630	M6	5	30	7	1,2	7,8	30

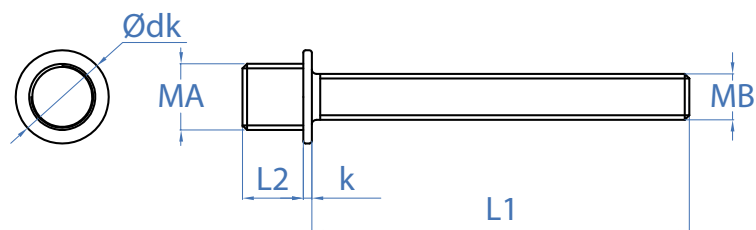

AB-TR

Tornillo doble para abrazaderas

CÓDIGO	MÉTRICA	L1	L2	K	ØDK
ABTR05030	M7	30	6	1	9
ABTR05040	M7	40	6	1	9
ABTR05050	M7	50	6	1	9
ABTR05060	M7	60	6	1	9
ABTR06040	M7	40	6	1	9
ABTR06050	M7	50	6	1	9
ABTR06060	M7	60	6	1	9

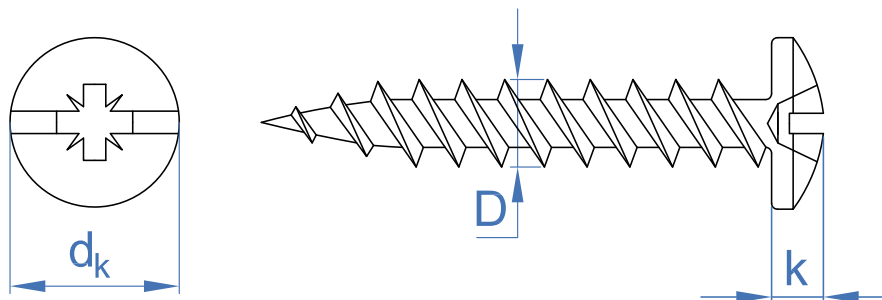

AB-TG

Tirafondo grapa. Huella combi

CÓDIGO	LONGITUD	LLAVE DE INSTALACIÓN	ØDK	K	ØD (MM)
ABTG4530	30	PZ2	10	3	4,5
ABTG4535	35	PZ2	10	3	4,5
ABTG4540	40	PZ2	10	3	4,5
ABTG5030	30	PZ3	12	3	5
ABTG5040	40	PZ3	12	3	5

ES-DR

Espárrago de doble rosca

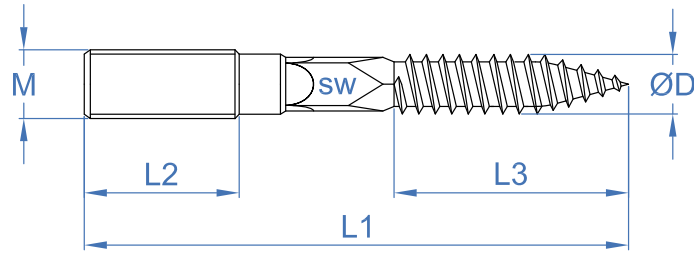

ES-DR

Cincado. Tx

CÓDIGO	MÉTRICA	LONGITUD	ØD (MM)	LLAVE DE INSTALACIÓN (SW)	L1	L2	L3
ESDR06040	M6	40	6	-	40	12	24
ESDR06050	M6	50	6	-	50	16	28,5
ESDR06060	M6	60	6	-	60	18	34,5
ESDR06070	M6	70	6	-	70	26	34,5
ESDR06080	M6	80	6	-	80	34	34,5
ESDR08050	M8	50	7	-	50	13	29,5
ESDR08060	M8	60	7	-	60	15	37,5
ESDR08070	M8	70	7	-	70	25	37,5
ESDR08080	M8	80	7	6	80	28,5	37,5
ESDR08090	M8	90	7	6	90	28,5	48,5
ESDR08100	M8	100	7	6	100	33,5	48,5
ESDR08110	M8	110	7	6	110	42,5	48,5
ESDR08120	M8	120	7	6	120	50	48,5
ESDR08130	M8	130	7	6	130	50	48,5
ESDR10080	M10	80	8	8	80	18	46,5
ESDR10100	M10	100	9	8	100	24	57
ESDR10110	M10	110	9	8	110	38	57
ESDR10120	M10	120	9	8	120	45	57
ESDR10130	M10	130	9	8	130	50	57
ESDR10140	M10	140	9	8	140	50	57
ESDR10150	M10	150	9	8	150	50	57
ESDR10180	M10	180	9	8	180	50	57
ESDR10200	M10	200	9	8	200	50	57

ES-DA2

Inoxidable A2. Tx

CÓDIGO	MÉTRICA	LONGITUD	ØD (MM)	LLAVE DE INSTALACIÓN (SW)	L1	L2	L3
ESDA208060	M8	60	7	6	60	20	30
ESDA210060	M10	60	9	8	60	20	30

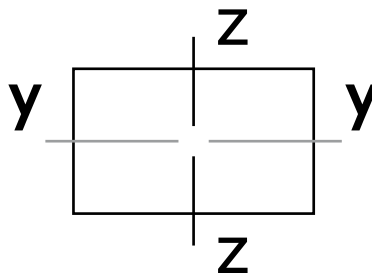
ASPECTOS GEOMÉTRICOS

CÓDIGO	SECCIÓN	PESO	ÁREA	MOMENTO INERCIA (I _y)	MOMENTO INERCIA (I _z)	MÓDULO RESISTENTE (W _y)	MÓDULO RESISTENTE (W _z)
	[mm x mm]	[Kg/m]	[cm ²]	[cm ⁴]	[cm ⁴]	[cm ³]	[cm ³]
GPZ201010	20 x 10	0.31	0.44	0.06	0.25	0.10	0.25
GPZ250808	25 x 8	0.26	0.35	0.03	0.30	0.06	0.24
GPG271812	27 x 18	0.66	0.84	0.37	0.97	0.34	0.71
GPG283018	28 x 30	1.25	1.60	1.79	2.10	1.03	1.50
GPG384020	38 x 40	2.00	2.55	5.39	6.18	2.39	3.25
GPG402015	40 x 20	0.94	1.30	0.71	3.10	0.57	1.55
GPP271812	27 x 18	0.66	0.84	0.37	0.97	0.34	0.71
GPI271812	27 x 18	0.66	0.79	0.36	0.90	0.33	0.67
GPI283015	28 x 30	1.25	1.37	1.54	1.82	0.89	1.30
GPX412115	41 x 21	1.21	1.41	0.89	3.58	0.70	1.75
GPX412120	41 x 21	1.55	1.99	0.95	4.44	0.75	2.17
GPX412125	41 x 21	1.71	2.28	1.32	5.54	1.03	2.70
GPX414115	41 X 41	1.65	2.42	4.88	5.99	2.05	2.92
GPX414120	41 x 41	2.09	2.65	5.84	7.62	2.46	3.72
GPX414125	41 x 41	2.53	3.28	7.08	9.25	2.98	4.51
GPX2M412120	41 x 21	1.55	1.99	0.95	4.44	0.75	2.17
GPX2M414120	41 x 41	2.09	2.65	5.84	7.62	2.46	3.72
SPZ271820	27 x 18	1,2	0.84	0.37	0.97	0.34	0.71
SPZ271830	27 x 18	1,2	0.84	0.37	0.97	0.34	0.71
SPZ384020	38 x 40	2,4	2.55	5.39	6.18	2.39	3.25
SPZ384025	38 x 40	2,4	2.55	5.39	6.18	2.39	3.25
SPZ384030	38 x 40	2,4	2.55	5.39	6.18	2.39	3.25
SPZ384035	38 x 40	2,4	2.55	5.39	6.18	2.39	3.25
SPZ384040	38 x 40	2,4	2.55	5.39	6.18	2.39	3.25
SPZ384050	38 x 40	2,4	2.55	5.39	6.18	2.39	3.25
SPZ384060	38 x 40	2,4	2.55	5.39	6.18	2.39	3.25
SPX412115	41 x 21	1,88	2.28	1.32	5.54	1.03	2.70
SPX412130	41 x 21	1,88	2.28	1.32	5.54	1.03	2.70
SPX412145	41 x 21	1,88	2.28	1.32	5.54	1.03	2.70
SPX414115	41 x 41	2,7	3.28	7.08	9.25	2.98	4.51
SPX414130	41 x 41	2,7	3.28	7.08	9.25	2.98	4.51
SPX414145	41 x 41	2,7	3.28	7.08	9.25	2.98	4.51
SPX414160	41 x 41	2,7	3.28	7.08	9.25	2.98	4.51
SPX414175	41 x 41	2,7	3.28	7.08	9.25	2.98	4.51
SPX414110	41 x 41	2,7	3.28	7.08	9.25	2.98	4.51

RED COMERCIAL ESPAÑA

ÁLAVA

Adrián Apellaniz
aapellaniz@indexfix.com
Tfno. 747 435 997

ALBACETE

Antonio Álvarez
a.alvarezmegias@gmail.com
Tfno. 678 537 861

ALICANTE

Maxi Flores
representacionesvalentin@gmail.com
Tfno. 647 447 793

ALMERÍA

José María Perez Capel
representaciones@perezcapel.com
Tfno. 683 353 495

ANDORRA

Pere Soro
peresoro@gmail.com
Tfno. 609 363 693

ASTURIAS

David Barreiro
dbarreiro@indexfix.com
Tfno. 680 748 731

ÁVILA

Vicente Beltrán
vicentebeltran@telefonica.net
Tfno. 609 616 926

BADAJOS

Andrés Jimenez
ajimenez@indexfix.com
Tfno. 688 757 352

BALEARES

Antonio Forteza
repforpa@gmail.com
Tfno. 636 973 665
Agustín Forteza
repreforteza@gmail.com
Tfno. 660 725 880

BARCELONA - TARRAGONA

Roger Rosell
rrosell@indexfix.com
Tfno. 618 361 743
Raul Sanchez
rlsanchez@indexfix.com
Tfno. 619 033 535

BURGOS

Adrián Apellaniz
aapellaniz@indexfix.com
Tfno. 629 777 206

CÁCERES

Andrés Jimenez
ajimenez@indexfix.com
Tfno. 688 757 352

CÁDIZ

José Antonio Prieto
prietocadiz@yahoo.es
Tfno. 667 552 000

CANARIAS

Alfredo Carrancio Sosa
acarrancio@indexfix.com
Tfno. 600 462 930

CANTABRIA

Rubén Alonso
ralonso@indexfix.com
Tfno. 679 559 519

CASTELLÓN

Francisco Blasco
representacionesblasco@gmail.com
Tfno. 639 672 267

CEUTA

Luis Fernando Reguera
luis@representacionesreguera.com
Tfno. 696 416 886

CIUDAD REAL

Vicente Beltrán
vicentebeltran@telefonica.net
Tfno. 609 616 926

CÓRDOBA

Eduardo de la Torre
edelatorre@indexfix.com
Tfno. 648 068 528

CUENCA

Vicente Beltrán
vicentebeltran@telefonica.net
Tfno. 609 616 926

GERONA

David Mejías
lunadarepres@gmail.com
Tfno. 622 453 509

GRANADA

Ismael Marco
ismaelmarcorios@gmail.com
Tfno. 670 242 337
Armando Ríos
Tfno. 670 453 269

GUADALAJARA

Vicente Beltrán
vicentebeltran@telefonica.net
Tfno. 609 616 926

GUIPÚZCOA

Koldo Balda González
baldasl@yahoo.es
Tfno. 629 476 660

HUELVA

Jose M^o Castillo
jmcastilloq@yahoo.es
Tfno. 667 769 427

HUESCA

Fernando Gonzalo
fgonzalo@fgmsl.es
Tfno. 609 879 313

JAEN

Ismael Marco
ismaelmarcorios@gmail.com
Tfno. 670 242 337
Armando Ríos
Tfno. 670 453 269

LA CORUÑA

Carlos Seoane
cseoane@indexfix.com
Tfno. 618 614 872
Francisco Amil
famil@indexfix.com
Tfno. 659 693 787

LA RIOJA

Adrián Apellaniz
aapellaniz@indexfix.com
Tfno. 747 435 997

LEÓN

Francisco Viñuela
pacovinuelaleon@hotmail.com
Tfno. 670 597 272

LLEIDA

Pere Soro
peresoro@gmail.com
Tfno. 609 363 693

LUGO

Carlos Seoane
cseoane@indexfix.com
Tfno. 618 614 872
Francisco Amil
famil@indexfix.com
Tfno. 659 693 787

MADRID

Sergio de Miguel
sdemiguel@indexfix.com
Tfno. 608 566 769
Cristina Conde
cconde@indexfix.com
Tfno. 638 547 099
Francisco Hernandez
fhernandez@indexfix.com
Tfno. 747 449 280

MÁLAGA

Enrique Martín
repmartin@hotmail.com
Tfno. 667 574 316

MELILLA

Enrique Martín
repmartin@hotmail.com
Tfno. 667 574 316

MURCIA

Facundo Cuenca e Hijos, S.L.
info@facundocuenca.com
Tfno. 968 898 167

NAVARRA

Eduardo Pellejero
epellejerobalda@telefonica.net
Tfno. 658 842 592

ORENSE

Carlos Seoane
cseoane@indexfix.com
Tfno. 618 614 872

PALENCIA

Adrián Apellaniz
aapellaniz@indexfix.com
Tfno. 747 435 997

PONTEVEDRA

Carlos Seoane
cseoane@indexfix.com
Tfno. 618 614 872

SALAMANCA

Javier Vecino
javiervicino@hotmail.com
Tfno. 609 811 878

SEGOVIA

Vicente Beltrán
vicentebeltran@telefonica.net
Tfno. 609 616 926

SEVILLA

José Antonio Bonilla
jabonilla@jabonilla.es
Tfno. 607 433 102

SORIA

Comercial Arrieta C.B.
gorka_arrieta@yahoo.es
Tfno. 619 416 914

TERUEL

Fernando Gonzalo
fgonzalo@fgmsl.es
Tfno. 609 879 313

TOLEDO

Vicente Beltrán
vicentebeltran@telefonica.net
Tfno. 609 616 926

VALENCIA

Francisco Blasco
representacionesblasco@gmail.com
Tfno. 639 672 267

VALLADOLID

Javier Vecino
javiervicino@hotmail.com
Tfno. 609 811 878

VIZCAYA

Rubén Alonso
ralonso@indexfix.com
Tfno. 679 559 519

ZAMORA

Francisco Viñuela
pacovinuelaleon@hotmail.com
Tfno. 670 597 272

ZARAGOZA

Fernando Gonzalo
fgonzalo@fgmsl.es
Tfno. 609 879 313

PRESENCIA INTERNACIONAL



FRANCIA - Aquitania, Languedoc-Rosellón, Lemosín, Mediodía-Pirineos

Thierry Nouvel
thierry@cnrpro.fr
+ 33 (0) 608.578.114

FRANCIA - Auvernia, Borgoña, Ródano-Alpes

Sales-up
Martin Broizart
m.broizat@directfab.fr
+ 33 (0) 665.493.382

FRANCIA - Bretaña, Países del Loira

Rodolphe Hirn
r.hirn@orange.fr
+ 33 (0) 676.282.469

FRANCIA - Isla de Francia

Geoffroy Ehlinger
geoffroyehlinger@yahoo.fr
+ 33 (0) 675.474.552

FRANCIA - Córcega

Franck Platerier
franck.platerier@sdpro.fr
+ 33 (0) 7 85 42 10 28

FRANCIA - DOM TOM

Florian Vergé
florian.verge@jv-ri.com
+ 33 (0) 468.691.968

FRANCIA - PACA

Jean Vivien
contact.sdpro@free.fr
+33 (0) 607.853.297

FRANCIA - ESTE

Frederic Koenig
fred.koenig@outlook.fr
+ 33 (0) 633454230

FRANCIA - NORTE Y NORMANDÍA

Eric Ducrocq
educrocq@ixsaw.com
+ 33 (0) 6 85 52 13 05

ALEMANIA

Dieter Fernandez
dfernandez@indexfix.com
+ 49 (0) 171 27 64 898

Ben Tauber
btauber@indexfix.com
+ 49 1520 7889077

ITALIA

Thomas Deppieri
tdeppieri@indexfix.com
+34 648060004

RUMANÍA

Dacian Lupu
dlupu@indexfix.com
+ 40 775 197 970

SENEGAL / COSTA DE MARFIL BENIN / CAMERÚN / GABÓN / CONGO

Florian Vergé
florian.verge@jv-ri.com
+ 33 (0) 468.691.968

MARRUECOS

NOUMAREP
Brahim Nouçair
noucairbrahim@gmail.com
+ 212 (0) 122.230.21.27

PORTUGAL

Marco Sousa
marcosousa@indexfix.com
+ 351 913.908.536

GRECIA

M.I. SASSON & CO O.E.
msaso@tee.gr
+ 30 6932 406 106

ALEMANIA
ARABIA SAUDITA
ARGELIA
AUSTRALIA
AUSTRIA
BANGLADESH
BÉLGICA
BENÍN
BOLIVIA
BOSNIA
BULGARIA
CAMERÚN
CHIPRE
COLOMBIA
CONGO
COSTA DE MARFIL
CROACIA
CUBA
DINAMARCA
EGIPTO
EMIRATOS ÁRABES
ESCOCIA
ESLOVENIA
ESTADOS UNIDOS
ESTONIA
FINLANDIA
FRANCIA
GABÓN
GRECIA
GUAYANA FRANCESA
GUINEA ECUATORIAL
HOLANDA
HONDURAS
HUNGRÍA
INDIA
INDONESIA
INGLATERRA
IRÁN
IRLANDA
IRLANDA DEL NORTE
ISLA GUADALUPE
ISLANDIA
ISRAEL
ITALIA
KOSOVO
KUWAIT
LETONIA
LÍBANO
LITUANIA
LUXEMBURGO
MACEDONIA
MADAGASCAR
MALTA
MARRUECOS
MARTINICA
MAURICIO
MÉXICO
MONTENEGRO
NORUEGA
NUEVA CALEDONIA
OMÁN
PAKISTÁN
PANAMÁ
PERÚ
POLINESIA FRANCESA
POLONIA
PORTUGAL
QATAR
REPUBLICA CHECA
REPUBLICA DOMINICANA
REPUBLICA ESLOVACA
REUNIÓN
RUMANIA
RUSIA
SENEGAL
SERBIA
SINGAPUR
SUECIA
SUIZA
TAILANDIA
TÚNEZ
TURQUÍA
UCRANIA
URUGUAY

A photograph of a cardboard box in a warehouse. The box is brown and features the INDEX logo in blue. The logo consists of a stylized 'I' made of three horizontal bars, followed by the word 'INDEX' in a bold, sans-serif font, and a registered trademark symbol (®). Below the logo is the slogan 'A PERFECT FIXING' in a smaller, all-caps, sans-serif font. The background is a blurred warehouse interior with a worker in a dark blue uniform on the left and various equipment and lights in the distance.

INDEX®
A PERFECT FIXING

CONDICIONES DE VENTA ESPAÑA

PORTES

Los portes serán pagados a partir de 300€ netos para los envíos a la península y Baleares. En este caso, nos reservamos el derecho a remitir las mercancías por nuestra habitual agencia de transportes.

En el caso de que los portes sean debidos y salvo indicación expresa por parte del cliente, las mercancías las enviaremos por nuestra habitual agencia de transportes.

Rogamos procedan a verificar el estado de la mercancía a su recepción y formulen ante el transportista las reservas que en su caso procedan, comunicándonos las posibles objeciones de inmediato.

La recepción de la mercancía, supone la aceptación de las condiciones generales de venta de INDEX A Perfect Fixing.

El importe mínimo de pedido es de 100€. Por cuestiones derivadas de costos y, en el caso de aceptarse un pedido de importe inferior, se cargarán 10€ en concepto de gastos de gestión.

CONDICIONES DE PAGO

Forma de pago: Giro bancario domiciliado a 60 días máximo.

Si las letras no están domiciliadas, INDEX A Perfect Fixing, en ningún caso se hará cargo de los posibles gastos de devolución.

Los documentos de pago, deberán ser remitidos en un plazo máximo de 30 días posteriores a la fecha de la factura.

Los documentos de pago que no respeten los vencimientos reflejados en nuestra factura, ocasionarán un cargo por aplazamiento del 1% mensual.

Nuestro sistema informático retendrá automáticamente los pedidos si se produjese algún impago o demora en la recepción de documentos de pago.

PLAZO DE ENTREGA

Salvo acuerdo expreso por nuestra Central, los plazos de entrega indicados por nuestros representantes son a título orientativo.

El retraso de los plazos de entrega o fechas previstas no dará lugar a penalización.

AGOSTO Y DICIEMBRE

Los vencimientos que se atiendan en estos meses, no tendrán cargos ni abonos. Si el vencimiento se fracciona al 50% entre el mes anterior y posterior, no se aplicarán cargos ni abonos.

Si el vencimiento se adelanta al mes anterior, se abonará en factura un 1% de descuento en concepto de pago adelantado.

Si el vencimiento se aplaza al mes siguiente, se cargará en factura un 1% en concepto de gastos financiero.

DEVOLUCIÓN DE MATERIAL

No se admitirán devoluciones de material transcurridos 15 días desde la fecha de entrega.

Si la devolución se produce por motivos no imputables a INDEX A Perfect Fixing el cliente la enviará a portes pagados. Adicionalmente se le cargará el coste que se origine en concepto de reempaquetado, así como los del transporte del envío inicial. En total el recargo supondrá un 20% aproximado del valor de la mercancía.

El importe de la mercancía devuelta o abono, será descontado de la factura de origen y se le notificará al cliente.

No se admitirán devoluciones de material a portes debidos, si no vienen por nuestras agencias habituales de transporte.

Para cualquier cuestión derivada de la venta efectuada por INDEX A Perfect Fixing (Técnicas Expansivas, S.L.), serán competentes los Juzgados y Tribunales de la ciudad de Logroño. Los precios de esta tarifa, no incluyen el IVA. INDEX A Perfect Fixing se reserva el derecho a cambiar precios, envasados o artículos en stock sin previo aviso.

INDEX A Perfect Fixing, a razón de sus necesidades de producción, se reserva el derecho a modificar sin previo aviso el diseño, las características o prestaciones de sus productos. Las imágenes de este catálogo, son ilustraciones informativas sin ningún valor contractual, pudiendo no coincidir con el modelo original.

Ref	pág	Ref	pág	Ref	pág	Ref	pág	Ref	pág		
975A2M04	324	9758ZM06	324	AB7IDZ2224	267	ABAI540114	257	ABE4819	154	ABE166325	155
975A2M04	373	9758ZM08	324	AB7IDZ2628	267	ABAI540133	257	ABE4825	154	ABE166325CP	155
975A2M05	324	9758ZM10	324	AB7IZ010	266	ABAI540140	257	ABE4832	154	ABE166332	155
975A2M05	373	9758ZM12	324	AB7IZ012	266	ABAI540159	257	ABE4838	154	ABE166338	155
975A2M06	324	9758ZM14	324	AB7IZ014	266	ABAI540168	257	ABE5519	154	ABE166350	155
975A2M06	373	9758ZM16	324	AB7IZ016	266	ABAI540219	257	ABE5522	154	ABE166363	155
975A2M08	324	9758ZM18	324	AB7IZ018	266	ABBU1315	271	ABE5525	154	ABE166375	155
975A2M08	373	9758ZM20	324	AB7IZ020	266	ABBU1618	271	ABE5532	154	ABE166380	155
975A2M10	324	9758ZM22	324	AB7IZ022	266	ABBU1921	271	ABE5538	154	ABE166390	155
975A2M10	373	9758ZM24	324	AB7IZ024	266	ABCH00034	274	ABE5550	154	ABE184819	155
975A2M12	324	9758ZM27	324	AB7IZ026	266	ABCH01000	274	ABE5563	154	ABE184825	155
975A2M12	373	9758ZM30	324	AB7IZ028	266	ABCH01012	274	ABE5575	154	ABE184838	155
975A2M14	324	9758ZM33	324	AB7IZ032	266	ABCH01014	274	ABE6310	154	ABE185522	155
975A2M14	373	9758ZM36	324	AB7IZ034	266	ABCH02000	274	ABE6311	154	ABE185525	155
975A2M16	324	AACAR06	68	AB7IZ036	266	ABCH02012	274	ABE6312	154	ABE185532	155
975A2M16	373	AACAR08	68	AB7IZ038	266	ABCH03000	274	ABE6313	154	ABE185538	155
975A2M18	324	AACAR10	68	AB7IZ040	266	ABCH04000	274	ABE6314	154	ABE185550	155
975A2M18	373	AACAR12	68	AB7IZ050	266	ABCH05000	274	ABE6315	154	ABE185563	155
975A2M20	324	AACCA06	68	ABA4832	170	ABCH06000	274	ABE6316	154	ABE186310	155
975A2M20	373	AACCA08	68	ABA4838	170	ABCH08000	274	ABE6318	154	ABE186311	155
975A2M22	324	AACCA10	68	ABA4845	170	ABCH10000	274	ABE6319	154	ABE186312	155
975A2M22	373	AACCA12	68	ABA4850	170	ABCH12000	274	ABE6320	154	ABE186313	155
975A2M24	324	AACCA16	68	ABA5538	170	ABCH14000	274	ABE6322	154	ABE186314	155
975A2M24	373	AACCI06	68	ABA5545	170	ABCH16000	274	ABE6324	154	ABE186319	155
975A2M27	324	AACCI06	348	ABA5555	170	ABCIKIT25	274	ABE6325	154	ABE186325	155
975A2M27	373	AACCI08	68	ABA5565	170	ABCIKIT30	274	ABE6332	154	ABE186332	155
975A2M30	324	AACCI08	348	ABA6360	170	ABCR010	271	ABE6338	154	ABE186338	155
975A2M30	373	AACCI10	68	ABA6370	170	ABCR012	271	ABE6350	154	ABE186350	155
975A2M33	324	AACCI10	348	ABA6385	170	ABD6012	265	ABE6363	154	ABE186363	155
975A2M33	373	AACCI12	68	ABAI513010	257	ABD6015	265	ABE6375	154	ABE186375	155
975A2M36	324	AACCI12	348	ABAI513012	257	ABD6018	265	ABE6380	154	ABE186380	155
975A2M36	373	AACES06	68	ABAI513015	257	ABD6022	265	ABE6390	154	ABE186390	155
975ZM2M06	325	AACES08	68	ABAI513018	257	ABD6028	265	ABE144219	155	ABE255522	155
975ZM2M08	325	AACES10	68	ABAI513022	257	ABDI0012	265	ABE144225	155	ABE255525	155
975ZM2M10	325	AACES12	68	ABAI513028	257	ABDI0015	265	ABE144816	155	ABE256310	155
975ZM04	324	AACGA06	68	ABAI519010	257	ABDI0018	265	ABE144819	155	ABE256311	155
975ZM05	324	AACGA08	68	ABAI519012	257	ABDI0022	265	ABE144819CP	155	ABE256312	155
975ZM06	324	AACGA10	68	ABAI519015	257	ABDI0028	265	ABE144825	155	ABE256313	155
975ZM08	324	AACGA12	68	ABAI519017	257	ABDZ6012	265	ABE144832	155	ABE256314	155
975ZM10	324	AACTO06	68	ABAI519018	257	ABDZ6015	265	ABE144838	155	ABE256325	155
975ZM12	324	AACTO08	68	ABAI519022	257	ABDZ6018	265	ABE145522	155	ABE256332	155
975ZM14	324	AACTO10	68	ABAI519028	257	ABDZ6022	265	ABE145532	155	ABE256338	155
975ZM16	324	AACTO12	68	ABAI519035	257	ABDZ6028	265	ABE164219	155	ABE256350	155
975ZM18	324	AACTO16	68	ABAI519042	257	ABDZ70810	266	ABE164816	155	ABE256363	155
975ZM20	324	AB6I012	265	ABAI519054	257	ABDZ70102	266	ABE164819	155	ABE256380	155
975ZM22	324	AB6I015	265	ABAI519060	257	ABDZ71214	266	ABE164819CP	155	ABE256390	155
975ZM24	324	AB6I016	265	ABAI519064	257	ABDZ71416	266	ABE164825	155	ABEBO10	330
975ZM27	324	AB6I018	265	ABAI519067	257	ABDZ71618	266	ABE164832	155	ABEBO13	330
975ZM30	324	AB6I022	265	ABAI519076	257	ABDZ71820	266	ABE164838	155	ABE14213	154
975ZM33	324	AB6I026	265	ABAI519080	257	ABDZ72022	266	ABE165519	155	ABE14213	353
975ZM36	324	AB6I028	265	ABAI519114	257	ABDZ72224	266	ABE165522	155	ABE14216	154
6921108020	230	AB6I032	265	ABAI530027	257	ABDZ72628	266	ABE165522CP	155	ABE14216	353
6921108020	307	AB6I035	265	ABAI530034	257	ABE3509	154	ABE165525	155	ABE14219	154
6921108020	359	AB6I042	265	ABAI530042	257	ABE3513	154	ABE165532	155	ABE14219	353
6921108020	368	AB6I048	265	ABAI530049	257	ABE3516	154	ABE165538	155	ABE14813	154
6921108050	230	AB6I054	265	ABAI530054	257	ABE3519	154	ABE165550	155	ABE14813	353
6921108050	307	AB6I060	265	ABAI530060	257	ABE4213	154	ABE165563	155	ABE14816	154
6921108050	359	AB7IDZ0810	267	ABAI530076	257	ABE4216	154	ABE165575	155	ABE14816	353
6921108050	368	AB7IDZ1012	267	ABAI530089	257	ABE4219	154	ABE166310	155	ABE14819	154
6921108070	230	AB7IDZ1214	267	ABAI530108	257	ABE4225	154	ABE166311	155	ABE14819	353
6921108070	307	AB7IDZ1416	267	ABAI530114	257	ABE4232	154	ABE166312	155	ABE14825	154
6921108070	359	AB7IDZ1618	267	ABAI540049	257	ABE4238	154	ABE166313	155	ABE14825	353
6921108070	368	AB7IDZ1820	267	ABAI540060	257	ABE4813	154	ABE166314	155	ABE14832	154
9758ZM05	324	AB7IDZ2022	267	ABAI540089	257	ABE4816	154	ABE166319	155	ABE14832	353

Ref	pág	Ref	pág	Ref	pág	Ref	pág	Ref	pág		
ABEI5519	154	ABIA018	252	ABITS015	271	ABMS16	284	ABP3922	169	ABPRG40	284
ABEI5519	353	ABIA022	252	ABITS015	365	ABMS18	284	ABP3925	169	ABPRG50	284
ABEI5522	154	ABIA028	252	ABITS018	271	ABMS20	284	ABP3932	169	ABPT3513	170
ABEI5522	353	ABIA035	252	ABITS018	365	ABMS22	284	ABP3938	169	ABPT3516	170
ABEI5525	154	ABIA042	252	ABITS022	271	ABMS26	284	ABP4213	169	ABPT3519	170
ABEI5525	353	ABIA048	252	ABITS022	365	ABMS28	284	ABP4216	169	ABPT3913	170
ABEI6319	154	ABIA054	252	ABITS028	271	ABMUG15	283	ABP4219	169	ABPT3916	170
ABEI6319	353	ABIA060	252	ABITS028	365	ABMUG18	283	ABP4222	169	ABPT4213	170
ABEI6325	154	ABIA075	252	ABM6A2012	264	ABMUG22	283	ABP4225	169	ABPT4216	170
ABEI6325	353	ABIA090	252	ABM6A2012	363	ABMUG26	283	ABP4232	169	ABPT4219	170
ABERM06006	330	ABIA100	252	ABM6A2015	264	ABMUG32	283	ABP4238	169	ABPT4225	170
ABERM08010	330	ABIA110	252	ABM6A2015	363	ABMUG40	283	ABP4813	169	ABPT4232	170
ABERM08015	330	ABIA115	252	ABM6A2018	264	ABMUG48	283	ABP4816	169	ABPT4819	170
ABFC09	329	ABIA125	252	ABM6A2018	363	ABMZ6008	264	ABP4819	169	ABPT4825	170
ABFC14	329	ABICP060	256	ABM6A2020	264	ABMZ6010	264	ABP4825	169	ABPT4832	170
ABFC19	329	ABICP075	256	ABM6A2020	363	ABMZ6012	264	ABP4832	169	ABPT4838	170
ABFP25	329	ABICP090	256	ABM6A2022	264	ABMZ6014	264	ABP4838	169	ABPT4850	170
ABFP32	329	ABICP110	256	ABM6A2022	363	ABMZ6015	264	ABP4850	169	ABPU016	267
ABGA018	258	ABICP140	256	ABM6A2028	264	ABMZ6016	264	ABP5519	169	ABPU018	267
ABGA022	258	ABICP160	256	ABM6A2028	363	ABMZ6018	264	ABP5525	169	ABPU020	267
ABGA028	258	ABICP220	256	ABM6008	264	ABMZ6020	264	ABP5532	169	ABPU022	267
ABGA035	258	ABICP270	256	ABM6010	264	ABMZ6022	264	ABP5538	169	ABPU025	267
ABGA040	258	ABICP315	256	ABM6012	264	ABMZ6025	264	ABP5550	169	ABPU028	267
ABGA048	258	ABID012	283	ABM6014	264	ABMZ6026	264	ABPE028	274	ABPU032	267
ABGA054	258	ABID014	283	ABM6015	264	ABMZ6028	264	ABPE035	274	ABPU037	267
ABGA060	258	ABID016	283	ABM6016	264	ABMZ6032	264	ABPE040	274	ABPU040	267
ABGA075	258	ABID020	283	ABM6018	264	ABMZ6035	264	ABPE048	274	ABPU050	267
ABGA090	258	ABID028	283	ABM6020	264	ABMZ6037	264	ABPE060	274	ABPU063	267
ABGA100	258	ABIN012	282	ABM6022	264	ABMZ6040	264	ABPE075	274	ABR3509	166
ABGA110	258	ABIN014	282	ABM6025	264	ABMZ6042	264	ABPE090	274	ABR3509BLE	167
ABGA115	258	ABIN016	282	ABM6026	264	ABMZ6047	264	ABPE100	274	ABR3511	166
ABGA140	258	ABIN020	282	ABM6028	264	ABMZ6050	264	ABPE115	274	ABR3513	166
ABGA160	258	ABIN025	282	ABM6032	264	ABMZ6054	264	ABPE140	274	ABR3513BLE	167
ABGD012	272	ABIN028	282	ABM6035	264	ABMZ6060	264	ABPE160	274	ABR3516	166
ABGD015	272	ABIN032	282	ABM6037	264	ABMZ6063	264	ABPE220	274	ABR3516BLE	167
ABGD018	272	ABIN035	282	ABM6040	264	ABMZ7008	266	ABPI006	267	ABR3519	166
ABGD022	272	ABIP015	268	ABM6042	264	ABMZ7010	266	ABPI008	267	ABR3522	166
ABGD028	272	ABIP018	268	ABM6047	264	ABMZ7012	266	ABPI010	267	ABR3525	166
ABGM012	272	ABIP022	268	ABM6050	264	ABMZ7014	266	ABPI012	267	ABR3532	166
ABGM015	272	ABIP026	268	ABM6054	264	ABMZ7016	266	ABPI014	267	ABR3913	166
ABGM018	272	ABIP028	268	ABM6060	264	ABMZ7018	266	ABPI016	267	ABR3916	166
ABGM022	272	ABIP035	268	ABM6063	264	ABMZ7020	266	ABPI018	267	ABR3919	166
ABGM028	272	ABIP042	268	ABM8050	258	ABMZ7022	266	ABPI020	267	ABR3925	166
ABGM035	272	ABIP048	268	ABM8063	258	ABMZ7024	266	ABPI022	267	ABR3932	166
ABGS010	272	ABIP054	268	ABM8075	258	ABMZ7025	266	ABPI025	267	ABR4213	166
ABGS012	272	ABIP060	268	ABM8090	258	ABMZ7026	266	ABPI026	267	ABR4213BLE	167
ABGS015	272	ABIP067	268	ABM8110	258	ABMZ7028	266	ABPI028	267	ABR4216	166
ABGS018	272	ABIP075	268	ABM8125	258	ABMZ7032	266	ABPI032	267	ABR4216BLE	167
ABGS022	272	ABIP090	268	ABM8160	258	ABMZ7034	266	ABPI040	267	ABR4219	166
ABGS028	272	ABIR015	252	ABM8200	258	ABMZ7036	266	ABPI042	267	ABR4219BLE	167
ABGS035	272	ABIR018	252	ABM8250	258	ABMZ7038	266	ABPI047	267	ABR4222	166
ABGS042	272	ABIR022	252	ABM8315	258	ABMZ7040	266	ABPI050	267	ABR4225	166
ABGS054	272	ABIR028	252	ABMD10	284	ABMZ7050	266	ABPI063	267	ABR4232	166
ABGUG15	283	ABIR035	252	ABMD12	284	ABMZ7063	266	ABPID016	150	ABR4238	166
ABGUG18	283	ABIR040	252	ABMD14	284	ABP3509	169	ABPID020	150	ABR4250	166
ABGUG20	283	ABIR048	252	ABMD16	284	ABP3511	169	ABPID025	150	ABR4810	166
ABGUG22	283	ABIR054	252	ABMD18	284	ABP3513	169	ABPID032	150	ABR4811	166
ABGUG25	283	ABIR060	252	ABMD20	284	ABP3516	169	ABPM720	328	ABR4812	166
ABGUG28	283	ABITD015	271	ABMD22	284	ABP3519	169	ABPM730	328	ABR4813	166
ABGUG32	283	ABITD015	365	ABMD26	284	ABP3522	169	ABPM740	328	ABR4816	166
ABGUG40	283	ABITD018	271	ABMD28	284	ABP3525	169	ABPRG15	284	ABR4819	166
ABGUG50	283	ABITD018	365	ABMS10	284	ABP3913	169	ABPRG20	284	ABR4822	166
ABGX4121	300	ABITD022	271	ABMS12	284	ABP3916	169	ABPRG25	284	ABR4825	166
ABIA015	252	ABITD022	365	ABMS14	284	ABP3919	169	ABPRG32	284	ABR4825BLE	167

Ref	pág	Ref	pág	Ref	pág	Ref	pág	Ref	pág		
ABR4832	166	ABRC3925	168	ABREA2022	362	ABRI035	254	ABRIA2140	362	ABRT4813	168
ABR4838	166	ABRC3938	168	ABREA2028	253	ABRI040	254	ABRIA2160	255	ABRT4816	168
ABR4845	166	ABRC4213	168	ABREA2028	362	ABRI048	254	ABRIA2160	362	ABRT4819	168
ABR4850	166	ABRC4216	168	ABREA2035	253	ABRI054	254	ABRIA4018	255	ABRT4825	168
ABR4860	166	ABRC4219	168	ABREA2035	362	ABRI060	254	ABRIA4018	363	ABRT4832	168
ABR4875	166	ABRC4225	168	ABREA2040	253	ABRI070	254	ABRIA4022	255	ABRT4838	168
ABR4880	166	ABRC4232	168	ABREA2040	362	ABRI075	254	ABRIA4022	363	ABRT4845	168
ABR4890	166	ABRC4238	168	ABREA2048	253	ABRI083	254	ABRIA4028	255	ABRT4850	168
ABR5519	166	ABRC4810	168	ABREA2048	362	ABRI090	254	ABRIA4028	363	ABRT4860	168
ABR5522	166	ABRC4816	168	ABREA2054	253	ABRI100	254	ABRIA4035	255	ABRT4875	168
ABR5525	166	ABRC4819	168	ABREA2054	362	ABRI110	254	ABRIA4035	363	ABRT4880	168
ABR5532	166	ABRC4825	168	ABREA2060	253	ABRI115	254	ABRIA4040	255	ABRT4890	168
ABR5538	166	ABRC4832	168	ABREA2060	362	ABRI125	254	ABRIA4040	363	ABRT5519	168
ABR5545	166	ABRC4838	168	ABREA2075	253	ABRI133	254	ABRIA4048	255	ABRT5525	168
ABR5560	166	ABRC4845	168	ABREA2075	362	ABRI140	254	ABRIA4048	363	ABRT5532	168
ABR5573	166	ABRC4850	168	ABREA2090	253	ABRI150	254	ABRIA4054	255	ABRT5538	168
ABRA015	252	ABRC4860	168	ABREA2090	362	ABRI160	254	ABRIA4054	363	ABRT5560	168
ABRA018	252	ABRC4880	168	ABREA2110	253	ABRI180	254	ABRIA4060	255	ABRT5573	168
ABRA022	252	ABRC4890	168	ABREA2110	362	ABRI200	254	ABRIA4060	363	ABSA050100	259
ABRA028	252	ABRC5525	168	ABREA2115	253	ABRI220	254	ABRIA4075	255	ABSA050125	259
ABRA035	252	ABRC5573	168	ABREA2115	362	ABRI250	254	ABRIA4075	363	ABSA050200	259
ABRA042	252	ABRE018	253	ABREA2125	253	ABRI280	254	ABRIA4090	255	ABSA050300	259
ABRA048	252	ABRE022	253	ABREA2125	362	ABRI300	254	ABRIA4090	363	ABSA050400	259
ABRA054	252	ABRE028	253	ABREA2140	253	ABRI315	254	ABRIA4110	255	ABSA050500	259
ABRA060	252	ABRE035	253	ABREA2140	362	ABRI355	254	ABRIA4110	363	ABSA050600	259
ABRA075	252	ABRE040	253	ABREA2160	253	ABRI400	255	ABRIA4115	255	ABSAI00100	259
ABRA090	252	ABRE048	253	ABREA2160	362	ABRI450	255	ABRIA4115	363	ABSAI00125	259
ABRAI00	252	ABRE054	253	ABREA2200	253	ABRI500	255	ABRIA4125	255	ABSAI00200	259
ABRAI10	252	ABRE060	253	ABREA2200	362	ABRI560	255	ABRIA4125	363	ABSAI00300	259
ABRAI15	252	ABRE070	253	ABREA4018	254	ABRI600	255	ABRIA4140	255	ABSAI00400	259
ABRAI25	252	ABRE075	253	ABREA4018	362	ABRI630	255	ABRIA4140	363	ABSAI00500	259
ABRA23509	167	ABRE083	253	ABREA4022	254	ABRI710	255	ABRIA4160	255	ABSI003	268
ABRA23509	355	ABRE090	253	ABREA4022	362	ABRI800	255	ABRIA4160	363	ABSI004	268
ABRA23513	167	ABRE100	253	ABREA4028	254	ABRI900	255	ABRID016	256	ABSI005	268
ABRA23513	355	ABRE110	253	ABREA4028	362	ABRI910	255	ABRID020	256	ABSI006	268
ABRA23519	167	ABRE115	253	ABREA4035	254	ABRI911	255	ABRID025	256	ABSI007	268
ABRA23519	355	ABRE125	253	ABREA4035	362	ABRI912	255	ABRID032	256	ABSI008	268
ABRA24213	167	ABRE133	253	ABREA4040	254	ABRIA2018	255	ABRID040	256	ABSI009	268
ABRA24213	355	ABRE140	253	ABREA4040	362	ABRIA2018	362	ABRID050	256	ABSI010	268
ABRA24216	167	ABRE150	253	ABREA4048	254	ABRIA2022	255	ABRID063	256	ABSI011	268
ABRA24216	355	ABRE160	253	ABREA4048	362	ABRIA2022	362	ABRID075	256	ABSI012	268
ABRA24219	167	ABRE180	253	ABREA4054	254	ABRIA2028	255	ABRID090	256	ABSI013	268
ABRA24219	355	ABRE200	253	ABREA4054	362	ABRIA2028	362	ABRID110	256	ABSI014	268
ABRA24225	167	ABRE220	253	ABREA4060	254	ABRIA2035	255	ABRID125	256	ABSI015	268
ABRA24225	355	ABRE250	253	ABREA4060	362	ABRIA2035	362	ABRID140	256	ABSI016	268
ABRA24816	167	ABRE280	253	ABREA4075	254	ABRIA2040	255	ABRID160	256	ABSI017	268
ABRA24816	355	ABRE300	253	ABREA4075	362	ABRIA2040	362	ABRT3509	168	ABSI018	268
ABRA24819	167	ABRE315	253	ABREA4090	254	ABRIA2048	255	ABRT3513	168	ABSI019	268
ABRA24819	355	ABRE355	253	ABREA4090	362	ABRIA2048	362	ABRT3516	168	ABSI020	268
ABRA24825	167	ABRE400	253	ABREA4110	254	ABRIA2054	255	ABRT3519	168	ABSI021	268
ABRA24825	355	ABRE450	253	ABREA4110	362	ABRIA2054	362	ABRT3913	168	ABSI022	268
ABRA24832	167	ABRE500	253	ABREA4115	254	ABRIA2060	255	ABRT3916	168	ABSI025	268
ABRA24832	355	ABRE560	253	ABREA4115	362	ABRIA2060	362	ABRT3919	168	ABTA0630	327
ABRA24838	167	ABRE600	253	ABREA4125	254	ABRIA2075	255	ABRT3925	168	ABTA0640	327
ABRA24838	355	ABRE630	253	ABREA4125	362	ABRIA2075	362	ABRT4213	168	ABTA0650	327
ABRA24850	167	ABRE710	253	ABREA4140	254	ABRIA2090	255	ABRT4216	168	ABTA0730	327
ABRA24850	355	ABRE800	253	ABREA4140	362	ABRIA2090	362	ABRT4219	168	ABTA0740	327
ABRC3509	168	ABRE900	253	ABREA4160	254	ABRIA2110	255	ABRT4225	168	ABTA0750	327
ABRC3513	168	ABRE910	253	ABREA4160	362	ABRIA2110	362	ABRT4232	168	ABTA0760	327
ABRC3516	168	ABRE911	253	ABREA4200	254	ABRIA2115	255	ABRT4238	168	ABTA0770	327
ABRC3519	168	ABRE912	253	ABREA4200	362	ABRIA2115	362	ABRT4250	168	ABTA0780	327
ABRC3913	168	ABREA2018	253	ABRI018	254	ABRIA2125	255	ABRT4810	168	ABTA0840	327
ABRC3916	168	ABREA2018	362	ABRI022	254	ABRIA2125	362	ABRT4811	168	ABTA0860	327
ABRC3919	168	ABREA2022	253	ABRI028	254	ABRIA2140	255	ABRT4812	168	ABTA0880	327

Ref	pág	Ref	pág	Ref	pág	Ref	pág	Ref	pág		
ABTAI050	327	ACHG09C	60	ACHTA211C	57	AFRTI44835	201	AH12090	40	AH1AR0855	71
ABTAI070	327	ACHG10C	60	ACHTA211C	346	AFVEI44819	202	AH12100	40	AH1AR1065	71
ABTAI090	327	ACHG11C	60	ACHTA211L	57	AFVEI44828	202	AH12110	40	AH1AR1275	71
ABTA20630	327	ACHG12C	60	ACHTA211L	346	AFVEI44835	202	AH12120	40	AH1AR1690	71
ABTA20630	373	ACHG14C	60	ACHTA212C	57	AFZNI44819	201	AH12130	40	AHICA0645	70
ABTAB0630	327	ACHG16C	60	ACHTA212C	346	AFZNI44828	201	AH12140	40	AHICA0855	70
ABTAB0640	327	ACHGA208C	60	ACHTA212L	57	AFZNI44835	201	AH12160	40	AHICA1065	70
ABTAB0650	327	ACHGA208C	347	ACHTA212L	346	AGP023025	259	AH12180	40	AHICA1275	70
ABTC020	285	ACHGA210C	60	ACHTA214C	57	AGP026028	259	AH12200	40	AHICA1690	70
ABTC025	285	ACHGA210C	347	ACHTA214C	346	AGP029031	259	AH12220	40	AHICI0645	70
ABTD016	285	ACHGA212C	60	ACHTA214L	57	AGP032035	259	AH12250	40	AHICI0645	348
ABTD018	285	ACHGA212C	347	ACHTA214L	346	AGP036039	259	AH14120	40	AHICI0855	70
ABTD020	285	ACHGE10	60	ACHTA216C	57	AGP040043	259	AH14145	40	AHICI0855	348
ABTD022	285	ACHGE12	60	ACHTA216C	346	AGP044047	259	AH14170	40	AHICI1065	70
ABTD025	285	ACHGFO08C	60	ACHTA216L	57	AGP048051	259	AH14220	40	AHICI1065	348
ABTD028	285	ACHGFO10C	60	ACHTA216L	346	AGP052055	259	AH14250	40	AHIGA0645	71
ABTG4530	328	ACHGFO12C	60	ACHTA220C	57	AGP056059	259	AH16125	40	AHIGA0855	71
ABTG4535	328	ACHINB08C	59	ACHTA220C	346	AGP060063	259	AH16145	40	AHIGA1065	71
ABTG4540	328	ACHINB08L	59	ACHTPI08C	58	AGP064067	259	AH16170	40	AHIGA1275	71
ABTG5030	328	ACHINB10C	59	ACHTPI08C	347	AGP068073	259	AH16220	40	AHIGA1690	71
ABTG5040	328	ACHINB10L	59	ACHTPI08L	58	AGP074079	259	AH16250	40	AHITO0645	70
ABTO06015	268	ACHINN08C	59	ACHTPI08L	347	AGP080085	259	AH16280	40	AHITO0855	70
ABTR05030	327	ACHINN08L	59	ACHTP110C	58	AGP086091	259	AH20170	40	AHITO1065	70
ABTR05040	327	ACHINN10C	59	ACHTP110C	347	AGP092097	259	AH20220	40	AHITO1275	70
ABTR05050	327	ACHINN10L	59	ACHTP110L	58	AGP098103	259	AH20270	40	AHITO1690	70
ABTR05060	327	ACHT08C	57	ACHTP110L	347	AGP104112	259	AHAT06060	41	AIS08080	104
ABTR06040	327	ACHT08L	57	ACHTP112C	58	AGP113121	259	AHAT06080	41	AIS08100	104
ABTR06050	327	ACHT09C	57	ACHTP112C	347	AGP1212130	259	AHAT06100	41	AIS08120	104
ABTR06060	327	ACHT09L	57	ACHTP112L	58	AGP131139	259	AHAT08060	41	AIS08140	104
ABTS014	285	ACHT10C	57	ACHTP112L	347	AGP140148	259	AHAT08075	41	AISAM085	105
ABTS016	285	ACHT10L	57	ACHTPL08C	58	AGP149161	259	AHAT08090	41	AISCI0070	104
ABTS018	285	ACHT11C	57	ACHTPL08L	58	AGP162174	259	AHAT08115	41	AISCI0090	104
ABTS020	285	ACHT11L	57	ACHTPL10C	58	AH06060	40	AHAT08130	41	AISCI0100	104
ABTS022	285	ACHT12C	57	ACHTPL10L	58	AH06070	40	AHAT08155	41	AISCI0120	104
ABTS025	285	ACHT12L	57	ACHTPL12C	58	AH06080	40	AHAT10070	41	AISCI0140	104
ABTS028	285	ACHT14C	57	ACHTPL12L	58	AH06090	40	AHAT10080	41	AISCI0160	104
ABTS032	285	ACHT14L	57	ADUTC47	140	AH06100	40	AHAT10090	41	AISCI0180	104
ACHA08C	61	ACHT16C	57	ADUTC60	140	AH06110	40	AHAT10100	41	AISCI0200	104
ACHA09C	61	ACHT16L	57	AFAZI44819	202	AH06120	40	AHAT10120	41	AISCI0220	104
ACHA10C	61	ACHT20C	57	AFAZI44828	202	AH06130	40	AHAT10140	41	AISCI0260	104
ACHA11C	61	ACHT25C	57	AFAZI44835	202	AH06140	40	AHAT10150	41	AISM08090	105
ACHA12C	61	ACHT8808C	58	AFBLI44819	203	AH06150	40	AHAT10160	41	AISM08110	105
ACHA14C	61	ACHT8808E	58	AFBLI44828	203	AH06160	40	AHAT10170	41	AISM08120	105
ACHA16C	61	ACHT8808L	58	AFBLI44835	203	AH06170	40	AHAT10210	41	AISM08140	105
ACHAA208C	61	ACHT8810C	58	AFGR144819	203	AH06180	40	AHAT12090	41	AISM08170	105
ACHAA208C	347	ACHT8810E	58	AFGR144828	203	AH08060	40	AHAT12100	41	AISM08200	105
ACHAA210C	61	ACHT8810L	58	AFGR144835	203	AH08075	40	AHAT12110	41	AISM08250	105
ACHAA210C	347	ACHT8812C	58	AFMCI44819	202	AH08090	40	AHAT12130	41	AISM08300	105
ACHAA212C	61	ACHT8812L	58	AFMCI44828	202	AH08100	40	AHAT12140	41	AISR140	104
ACHAA212C	347	ACHT8816C	58	AFMCI44835	202	AH08115	40	AHAT12160	41	AISS10070	104
ACHAFO08C	61	ACHT8816L	58	AFMDI44819	202	AH08120	40	AHAT12180	41	AISS10090	104
ACHAFO10C	61	ACHT8820C	58	AFMDI44828	202	AH08130	40	AHAT12200	41	AISS10100	104
ACHAFO12C	61	ACHTA208C	57	AFMDI44835	202	AH08155	40	AHAT12220	41	AISS10120	104
ACHE08C	59	ACHTA208C	346	AFNEI44819	203	AH10070	40	AHAT12250	41	AISS10140	104
ACHE09C	59	ACHTA208L	57	AFNEI44828	203	AH10080	40	AHAT16125	41	AISS10160	104
ACHE10C	59	ACHTA208L	346	AFNEI44835	203	AH10090	40	AHAT16145	41	AISS10180	104
ACHE10L	59	ACHTA209C	57	AFPGI44819	203	AH10100	40	AHAT16170	41	AISS10200	104
ACHE11C	59	ACHTA209C	346	AFPGI44828	203	AH10120	40	AHAT16220	41	AISS10220	104
ACHE11L	59	ACHTA209L	57	AFPGI44835	203	AH10140	40	AHAT16250	41	AISS10260	104
ACHE12C	59	ACHTA209L	346	AFRDI44819	202	AH10150	40	AHAT16280	41	AISW060	105
ACHE12L	59	ACHTA210C	57	AFRDI44828	202	AH10160	40	AHAT20170	41	ALHA14025	209
ACHE14C	59	ACHTA210C	346	AFRDI44835	202	AH10170	40	AHAT20220	41	ALHA16030	209
ACHE14L	59	ACHTA210L	57	AFRTI44819	201	AH10210	40	AHAT20270	41	ALHA17040	209
ACHG08C	60	ACHTA210L	346	AFRTI44828	201	AH10230	40	AH1AR0645	71	ALHA18040	209

Ref	pág	Ref	pág	Ref	pág	Ref	pág	Ref	pág		
ALHA18050	209	ALRO20070	207	AMI4145	43	APA408075	37	APAT12120	38	APG20170	39
ALHA19050	209	ALRO20080	207	AMI4170	43	APA408075	344	APAT12130	38	APG20170	39
ALHA19060	209	ALRO21080	207	AMI4220	43	APA408095	37	APAT12150	38	APG20200	39
ALHA19070	209	ALRO21090	207	AMI4250	43	APA408095	344	APAT12180	38	APG20200	39
ALHA20050	209	ALRO22100	207	AMI6090	43	APA408115	37	APAT12200	38	APPD100	223
ALHA20060	209	ALRO22110	207	AMI6110	43	APA408115	344	APAT16145	38	APPG070	223
ALHA20070	209	ALRO22120	207	AMI6125	43	APA408135	37	APAT16175	38	APPG100	223
ALHA20080	209	ALRO23130	207	AMI6145	43	APA408135	344	APAT16220	38	APPPT071	224
ALHA21070	209	ALROB16030	207	AMI6170	43	APA410090	37	APAT20170	38	APPPT091	224
ALHA21080	209	ALROB17040	207	AMI6220	43	APA410090	344	APAT20200	38	APPPT101	224
ALHA21090	209	ALROB18050	207	AMI6250	43	APA410105	37	APEN71	224	APSB71	224
ALHA21100	209	ALROB19060	207	AMI6280	43	APA410105	344	APEN91	224	APSB91	224
ALHA22110	209	AM06045	43	AM20120	43	APA410115	37	APFL801020	223	APUEZ200	224
ALHA22120	209	AM06055	43	AM20170	43	APA410115	344	APFUZ100	223	APX08050	38
ALHA23130	209	AM06060	43	AM20220	43	APA410135	37	APG06060	39	APX08075	38
ALHAB16030	209	AM06065	43	AM20270	43	APA410135	344	APG06060	39	APX08080	38
ALHAB17040	209	AM06070	43	AM24180	43	APA410165	37	APG06070	39	APX08095	38
ALHAB18050	209	AM06080	43	AM24260	43	APA410165	344	APG06070	39	APX08115	38
ALHAB19060	209	AM06085	43	ANCLA40	112	APA410185	37	APG06100	39	APX10090	38
ALHC14025	208	AM06090	43	ANCLA47	112	APA410185	344	APG06100	39	APX10105	38
ALHC16030	208	AM06100	43	ANCU06040	66	APA412110	37	APG08050	39	APX10115	38
ALHC17040	208	AM06110	43	ANCU06040	274	APA412110	344	APG08050	39	APX10135	38
ALHC18040	208	AM06120	43	ANCU06070	66	APA412120	37	APG08060	39	APX10165	38
ALHC18050	208	AM06130	43	ANCU06070	274	APA412120	344	APG08060	39	APX10185	38
ALHC19050	208	AM06140	43	ANFA2309	72	APA412130	37	APG08075	39	APX12080	38
ALHC19060	208	AM06150	43	ANFA2312	72	APA412130	344	APG08075	39	APX12100	38
ALHC19070	208	AM06160	43	ANFA2316	72	APA412150	37	APG08095	39	APX12110	38
ALHC20050	208	AM06170	43	ANFA2319	72	APA412150	344	APG08095	39	APX12120	38
ALHC20060	208	AM06180	43	ANFA2323	72	APA412180	37	APG08115	39	APX12130	38
ALHC20070	208	AM08050	43	ANFA2330	72	APA412180	344	APG08115	39	APX12150	38
ALHC20080	208	AM08060	43	ANFA2335	72	APA412200	37	APG10070	39	APX12180	38
ALHC21070	208	AM08065	43	ANFA5114	72	APA412200	344	APG10070	39	APX12200	38
ALHC21080	208	AM08075	43	ANFA5116	72	APA416125	37	APG10090	39	APX12220	38
ALHC21090	208	AM08090	43	ANFA5120	72	APA416125	344	APG10090	39	APX12255	38
ALHC21100	208	AM08115	43	ANFA5124	72	APA416145	37	APG10105	39	APX16145	38
ALHC22110	208	AM08120	43	ANFATA37B	73	APA416145	344	APG10105	39	APX16175	38
ALHC22120	208	AM08130	43	ANFATA70B	73	APA416175	37	APG10115	39	APX16220	38
ALHC23130	208	AM08155	43	ANFAZ5021	72	APA416175	344	APG10115	39	APX16250	38
ALHCB16030	208	AM10065	43	AP08050	37	APA416190	37	APG10135	39	APX20170	38
ALHCB17040	208	AM10070	43	AP08075	37	APA416190	344	APG10135	39	APX20200	38
ALHCB18050	208	AM10080	43	AP08095	37	APA416220	37	APG10165	39	ARANE14	162
ALHCB19060	208	AM10090	43	AP08115	37	APA416220	344	APG10165	39	ARANE16	162
ALPL45060	206	AM10100	43	AP10090	37	APA420200	37	APG10185	39	ARANE18	162
ALPL45080	206	AM10120	43	AP10105	37	APA420200	344	APG10185	39	ARANE25	162
ALPL45100	206	AM10140	43	AP10115	37	APA420240	37	APG12080	39	ARE4816	156
ALPL50120	206	AM10150	43	AP10135	37	APA420240	344	APG12080	39	ARE4819	156
ALRE20015	206	AM10160	43	AP10165	37	APA420285	37	APG12110	39	ARE5522	156
ALRE25020	206	AM10170	43	AP10185	37	APA420285	344	APG12110	39	ARE6320	156
ALRE25025	206	AM10210	43	AP12080	37	APAR070	223	APG12130	39	ARE6325	156
ALRE25030	206	AM10230	43	AP12100	37	APAR150	223	APG12130	39	ARE6332	156
ALRE35040	206	AM12075	43	AP12110	37	APAT071	223	APG12150	39	ARE6338	156
ALRE35050	206	AM12080	43	AP12120	37	APAT091	223	APG12150	39	ARE6350	156
ALRE40060	206	AM12090	43	AP12130	37	APAT101	223	APG12180	39	ARE6363	156
ALRE40070	206	AM12100	43	AP12150	37	APAT08075	38	APG12180	39	ARE6380	156
ALRE40080	206	AM12110	43	AP12180	37	APAT08095	38	APG12200	39	ARE164816	156
ALRO14025	207	AM12120	43	AP12200	37	APAT08115	38	APG12200	39	ARE164819	156
ALRO16030	207	AM12140	43	AP16145	37	APAT10090	38	APG16125	39	ARE165522	156
ALRO17040	207	AM12160	43	AP16175	37	APAT10105	38	APG16125	39	ARE166320	156
ALRO18040	207	AM12180	43	AP16220	37	APAT10115	38	APG16145	39	ARE166325	156
ALRO18050	207	AM12220	43	AP16250	37	APAT10135	38	APG16145	39	ARE166332	156
ALRO19050	207	AM12250	43	AP20170	37	APAT10165	38	APG16175	39	ARE166338	156
ALRO19060	207	AM14080	43	AP20200	37	APAT10185	38	APG16175	39	ARE166350	156
ALRO19070	207	AM14100	43	AP24205	37	APAT12100	38	APG16220	39	ARENI166325	156
ALRO20060	207	AM14120	43	AP24235	37	APAT12110	38	APG16220	39	ARENI166325	314

ARFOM06Z	326	ASF2090110	364	ATAPO10PC	246	AVCI0180	72	AZAMT16	69	BB36200	279
ARFOM08Z	326	ASF2100120	269	ATAPO10RC	163	AVCI0180	348	AZIM060250	258	BB36250	279
ARFOM10Z	326	ASF2100120	364	ATAPO10RC	246	AVR08120	72	AZIM060375	258	BB36300	279
ARFOM12Z	326	ASF2110130	269	ATAPO10RT	163	AVR08120	348	AZIM060500	258	BB36370	279
ARFOM16Z	326	ASF2110130	364	ATAPO10RT	246	AVR08150	72	AZIM060750	258	BB48120	279
ARINO14	162	ASF2120140	269	ATAPO10RX	163	AVR08150	348	AZIM061000	258	BB48160	279
ARINO14	355	ASF2120140	364	ATAPO10RX	246	AVR10120	72	AZIM061250	258	BB48180	279
ARINO16	162	ASF2130150	269	ATAPO10VN	163	AVR10120	348	AZIM081500	258	BB48200	279
ARINO16	355	ASF2130150	364	ATAPO10VN	246	AVR10150	72	AZIM082000	258	BB48250	279
ARINO18	162	ASFIR03	270	AUE6310	159	AVR10150	348	AZIM082250	258	BB48290	279
ARINO18	355	ASFIR03	364	AUE6311	159	AVR10180	72	AZIM082500	258	BB48370	279
ARINO25	162	ASFIR30	270	AUE6312	159	AVR10180	348	AZIM083000	258	BB48430	279
ARINO25	355	ASFIR30	364	AUE6313	159	AZA2060500	259	AZIM083500	258	BB76150	279
ARINOM30	162	ASFIRCA	270	AUE6314	159	AZA2060500	363	AZIM084000	258	BB76200	279
ARINOM30	355	ASFIRCA	364	AUE6315	159	AZA2060750	259	AZIM084500	258	BB76290	279
ARPAR25	163	ATA4832	171	AUE6319	159	AZA2060750	363	AZIM085000	258	BB76370	279
ARPARA225	163	ATA4838	171	AUE6325	159	AZA2061000	259	AZIM086000	258	BB76450	279
ARPARA225	355	ATA4845	171	AUE6332	159	AZA2061000	363	AZIM103000	258	BB76540	279
ARSP08	316	ATA4850	171	AUE6340	159	AZA2061250	259	AZIM103500	258	BB88770	279
ARSP08	372	ATA5538	171	AUE6350	159	AZA2061250	363	AZIM104000	258	BBANA19	282
ARSP10	316	ATA5545	171	AUE6360	159	AZA2081500	259	AZIM105000	258	BBANA27	282
ARSP10	372	ATA5550	171	AUE6380	159	AZA2081500	363	AZIM106000	258	BBANET9	282
ARSS10	316	ATA5555	171	AUE166319	159	AZA2082000	259	AZIM108000	258	BBANE27	282
ARSS12	316	ATA5565	171	AUE166325	159	AZA2082000	363	BAESM04	108	BBISDS10210	309
ASF008016	269	ATA6310	171	AUE166332	159	AZA2082500	259	BAESM05	108	BBISDS16400	309
ASF012022	269	ATA6350	171	AUE166340	159	AZA2082500	363	BAESM06	108	BC25100AM	280
ASF016027	269	ATA6360	171	AUE166350	159	AZA2083000	259	BAESM08	108	BC25100AZ	280
ASF020032	269	ATA6370	171	AUE166360	159	AZA2083000	363	BAGAM04	108	BC25100GR	280
ASF025040	269	ATA6385	171	AUE166380	159	AZA2104000	259	BAGAM05	108	BC25100MA	280
ASF030045	269	ATAPO08AR	163	AUE186310	159	AZA2104000	363	BAGAM06	108	BC25100RO	280
ASF035050	269	ATAPO08AR	246	AUE186311	159	AZA2106000	259	BAGAM08	108	BC25100VE	280
ASF040060	269	ATAPO08BO	163	AUE186312	159	AZA2106000	363	BANYM05	108	BC36140AM	280
ASF050070	269	ATAPO08BO	246	AUE186313	159	AZA2108000	259	BANYM06	108	BC36140AZ	280
ASF060080	269	ATAPO08BP	163	AUE186314	159	AZA2108000	363	BAUTO5510	158	BC36140GR	280
ASF070090	269	ATAPO08BP	246	AUE186315	159	AZAMA06	70	BAUTO5510	354	BC36140MA	280
ASF080100	269	ATAPO08BS	163	AUE186325	159	AZAMA08	70	BAUTO5540	158	BC36140RO	280
ASF090110	269	ATAPO08BS	246	AUE186332	159	AZAMA10	70	BAUTO5540	354	BC36140VE	280
ASF100120	269	ATAPO08GM	163	AUE186340	159	AZAMA12	70	BAUTO5550	158	BC36200AM	280
ASF110130	269	ATAPO08GM	246	AUE186350	159	AZAMAFO06	70	BAUTO5550	354	BC36200AZ	280
ASF120140	269	ATAPO08NE	163	AUE186360	159	AZAMAFO08	70	BAUTO5565	158	BC36200GR	280
ASF130150	269	ATAPO08NE	246	AUE186380	159	AZAMAFO10	70	BAUTO5565	354	BC36200MA	280
ASF2010016	269	ATAPO08PC	163	AUE256325	159	AZAMAFO12	70	BAUTO5580	158	BC36200RO	280
ASF2010016	364	ATAPO08PC	246	AUEN1166325	159	AZAMC06	69	BAUTO5580	354	BC36200VE	280
ASF2012020	269	ATAPO08RC	163	AUEN1166325	315	AZAMC08	69	BAUTO165510	158	BC48200AM	280
ASF2012020	364	ATAPO08RC	246	AUTO510	157	AZAMC10	69	BAUTO165510	354	BC48200AZ	280
ASF2016027	269	ATAPO08RT	163	AUTO532	157	AZAMC12	69	BAUTO165540	158	BC48200GR	280
ASF2016027	364	ATAPO08RT	246	AUTO538	157	AZAMC16	69	BAUTO165540	354	BC48200MA	280
ASF2020032	269	ATAPO08RX	163	AUTO550	157	AZAME06	69	BAUTO165550	158	BC48200RO	280
ASF2020032	364	ATAPO08RX	246	AUTO560	157	AZAME08	69	BAUTO165550	354	BC48200VE	280
ASF2025040	269	ATAPO08VN	163	AUTO580	157	AZAME10	69	BAUTO165565	158	BC48290AM	280
ASF2025040	364	ATAPO08VN	246	AUTO16510	157	AZAME12	69	BAUTO165565	354	BC48290AZ	280
ASF2032050	269	ATAPO10AR	163	AUTO16532	157	AZAME16	69	BAUTO165580	158	BC48290GR	280
ASF2032050	364	ATAPO10AR	246	AUTO16538	157	AZAMG06	69	BAUTO165580	354	BC48290MA	280
ASF2040060	269	ATAPO10BO	163	AUTO16550	157	AZAMG08	69	BB12100	279	BC48290RO	280
ASF2040060	364	ATAPO10BO	246	AUTO16560	157	AZAMG10	69	BB12225	279	BC48290VE	280
ASF2050070	269	ATAPO10BP	163	AUTO16580	157	AZAMG12	69	BB12500	279	BCPA24214	172
ASF2050070	364	ATAPO10BP	246	AVC08120	72	AZAMGFO06	69	BB12720	279	BCPA24214	356
ASF2060080	269	ATAPO10BS	163	AVC08120	348	AZAMGFO08	69	BB12850	279	BCPA24223	172
ASF2060080	364	ATAPO10BS	246	AVC08150	72	AZAMGFO10	69	BB25080	279	BCPA24223	356
ASF2070090	269	ATAPO10GM	163	AVC08150	348	AZAMGFO12	69	BB25100	279	BCPB4214	172
ASF2070090	364	ATAPO10GM	246	AVCI0120	72	AZAMT06	69	BB25140	279	BCPB4223	172
ASF2080100	269	ATAPO10NE	163	AVCI0120	348	AZAMT08	69	BB25160	279	BCPN4214	172
ASF2080100	364	ATAPO10NE	246	AVCI0150	72	AZAMT10	69	BB25200	279	BCPN4223	172
ASF2090110	269	ATAPO10PC	163	AVCI0150	348	AZAMT12	69	BB36140	279	BCPZ4214	172

Ref	pág	Ref	pág	Ref	pág	Ref	pág	Ref	pág		
BCP24214BL	172	BN36300	279	BZ3I06030	228	BZ3Z08060	227	BZ902104	240	BZABP4219	169
BCP24223	172	BN36370	279	BZ3I06030	358	BZ3Z08070	227	BZ902105	240	BZABP4225	169
BCP24223BL	172	BN48120	279	BZ3I06040	228	BZ3Z08080	227	BZ902106	240	BZABP4232	169
BID25110	282	BN48160	279	BZ3I06040	358	BZ3Z10030	227	BZ902108	240	BZABR3509	166
BID25210	282	BN48180	279	BZ3I06050	228	BZ3Z10040	227	BZ902110	240	BZABR3513	166
BIE4825	157	BN48200	279	BZ3I06050	358	BZ3Z10050	227	BZ902112	240	BZABR3516	166
BIE4825	353	BN48250	279	BZ3I08016	228	BZ125IM04	239	BZ603905020	232	BZABR4213	166
BIE5525	157	BN48290	279	BZ3I08016	358	BZ125IM04	360	BZ603905030	232	BZABR4216	166
BIE5525	353	BN48370	279	BZ3I08020	228	BZ125IM05	239	BZ603905040	232	BZABR4219	166
BIE5532	157	BN48430	279	BZ3I08020	358	BZ125IM05	360	BZ603905050	232	BZABR4225	166
BIE5532	353	BN76150	279	BZ3I08025	228	BZ125IM06	239	BZ603906016	232	BZABR4232	166
BIE5538	157	BN76200	279	BZ3I08025	358	BZ125IM06	360	BZ603906020	232	BZABR4816	166
BIE5538	353	BN76290	279	BZ3I08030	228	BZ125IM08	239	BZ603906030	232	BZABR4819	166
BIE5550	157	BN76370	279	BZ3I08030	358	BZ125IM08	360	BZ603906040	232	BZABR4825	166
BIE5550	353	BN76450	279	BZ3I08040	228	BZ125IM10	239	BZ603906050	232	BZABR4832	166
BIE5558	157	BN76540	279	BZ3I08040	358	BZ125IM10	360	BZ603906060	232	BZABR4838	166
BIE5558	353	BN76750	279	BZ3I08050	228	BZ125ZM03	239	BZ603906070	232	BZABR4845	166
BIE5565	157	BN88122	279	BZ3I08050	358	BZ125ZM04	239	BZ603906080	232	BZABR4850	166
BIE5565	353	BN88770	279	BZ3I08060	228	BZ125ZM05	239	BZ603908025	232	BZABR4860	166
BIE5580	157	BN88920	279	BZ3I08060	358	BZ125ZM06	239	BZ603908030	232	BZACHA08C	61
BIE5580	353	BNDT25100	281	BZ3I10020	228	BZ125ZM08	239	BZ603908040	232	BZACHA10C	61
BIE6325	157	BNDT36150	281	BZ3I10020	358	BZ125ZM10	239	BZ603908050	232	BZACHA12C	61
BIE6325	353	BNDT36200	281	BZ3I10030	228	BZ125ZM12	239	BZ603908060	232	BZACHG08C	60
BIE45525	158	BNDT48200	281	BZ3I10030	358	BZ934IM04	236	BZ603908070	232	BZACHG10C	60
BIE45525	353	BNDT48300	281	BZ3I10040	228	BZ934IM04	359	BZ603908080	232	BZACHG12C	60
BIE45532	158	BNDT48370	281	BZ3I10040	358	BZ934IM05	236	BZ603908090	232	BZACHINB08C	59
BIE45532	353	BNDT76370	281	BZ3Z04008	227	BZ934IM05	359	BZ603910025	232	BZACHINB10C	59
BIE45550	158	BOCA006	245	BZ3Z04010	227	BZ934IM06	236	BZ603910030	232	BZACHT08C	57
BIE45550	353	BOCA007	245	BZ3Z04012	227	BZ934IM06	359	BZ603910040	232	BZACHT08L	57
BIE45565	158	BOCA008	245	BZ3Z04016	227	BZ934IM08	236	BZ603910050	232	BZACHT10C	57
BIE45565	353	BOCA010	245	BZ3Z04020	227	BZ934IM08	359	BZABE3509	154	BZACHT10L	57
BIE46325	158	BOCA013	245	BZ3Z04025	227	BZ934IM10	236	BZABE3513	154	BZACHT12C	57
BIE46325	353	BOCA055	245	BZ3Z04030	227	BZ934IM10	359	BZABE4213	154	BZACHT12L	57
BIE164825	157	BOCAL007	309	BZ3Z04035	227	BZ934ZM03	236	BZABE4216	154	BZALHA14025	209
BIE164825	353	BOCAL009	309	BZ3Z04040	227	BZ934ZM04	236	BZABE4219	154	BZALHA16030	209
BIE165525	157	BPL02616	282	BZ3Z04045	227	BZ934ZM05	236	BZABE4225	154	BZALHA17040	209
BIE165525	353	BZ3I04010	228	BZ3Z04050	227	BZ934ZM06	236	BZABE4813	154	BZALHA18040	209
BIE165532	157	BZ3I04010	358	BZ3Z04060	227	BZ934ZM08	236	BZABE4816	154	BZALHA18050	209
BIE165532	353	BZ3I04016	228	BZ3Z05010	227	BZ934ZM10	236	BZABE4819	154	BZALHA19050	209
BIE165538	157	BZ3I04016	358	BZ3Z05012	227	BZ934ZM12	236	BZABE4825	154	BZALHA19060	209
BIE165538	353	BZ3I04020	228	BZ3Z05015	227	BZ9021M04	240	BZABE4832	154	BZALHA19070	209
BIE165550	157	BZ3I04020	358	BZ3Z05016	227	BZ9021M04	361	BZABE4838	154	BZALHA20060	209
BIE165550	353	BZ3I04030	228	BZ3Z05020	227	BZ9021M05	240	BZABE5519	154	BZALHA20070	209
BIE165558	157	BZ3I04030	358	BZ3Z05025	227	BZ9021M05	361	BZABE5522	154	BZALHA20080	209
BIE165558	353	BZ3I04040	228	BZ3Z05030	227	BZ9021M06	240	BZABE5525	154	BZALHA21080	209
BIE165565	157	BZ3I04040	358	BZ3Z05035	227	BZ9021M06	361	BZABE5532	154	BZALHA21090	209
BIE165565	353	BZ3I05010	228	BZ3Z05040	227	BZ9021M08	240	BZABE5538	154	BZALHA21100	209
BIE165580	157	BZ3I05010	358	BZ3Z05045	227	BZ9021M08	361	BZABE5550	154	BZALHA22110	209
BIE165580	353	BZ3I05016	228	BZ3Z05050	227	BZ9021M10	240	BZABE6325	154	BZALHA22120	209
BIE166325	157	BZ3I05016	358	BZ3Z05060	227	BZ9021M10	361	BZABE6332	154	BZALHA23130	209
BIE166325	353	BZ3I05020	228	BZ3Z06016	227	BZ12703	241	BZABE6338	154	BZALHAB1630	209
BN12100	279	BZ3I05020	358	BZ3Z06020	227	BZ12704	241	BZABE6350	154	BZALHAB1740	209
BN12225	279	BZ3I05030	228	BZ3Z06025	227	BZ12705	241	BZABE144819	155	BZALHAB1850	209
BN12500	279	BZ3I05030	358	BZ3Z06030	227	BZ12706	241	BZABE144825	155	BZALHAB1960	209
BN12720	279	BZ3I05040	228	BZ3Z06040	227	BZ12708	241	BZABE165522	155	BZALHATS05	99
BN12850	279	BZ3I05040	358	BZ3Z06050	227	BZ12710	241	BZABE165525	155	BZALHATS06	99
BN25080	279	BZ3I05050	228	BZ3Z06060	227	BZ12712	241	BZABE165532	155	BZALHATS08	99
BN25100	279	BZ3I05050	358	BZ3Z06070	227	BZ158704	238	BZABE165538	155	BZALHC14025	208
BN25140	279	BZ3I06016	228	BZ3Z08016	227	BZ158705	238	BZABE165550	155	BZALHC16030	208
BN25160	279	BZ3I06016	358	BZ3Z08020	227	BZ158706	238	BZABE166325	155	BZALHC17040	208
BN25200	279	BZ3I06020	228	BZ3Z08025	227	BZ158708	238	BZABE166332	155	BZALHC18040	208
BN36140	279	BZ3I06020	358	BZ3Z08030	227	BZ158710	238	BZABE166338	155	BZALHC18050	208
BN36200	279	BZ3I06025	228	BZ3Z08040	227	BZ158712	238	BZABP3513	169	BZALHC19050	208
BN36250	279	BZ3I06025	358	BZ3Z08050	227	BZ902103	240	BZABP3516	169	BZALHC19060	208

Ref	pág	Ref	pág	Ref	pág	Ref	pág	Ref	pág	Ref	pág
BZALHC19070	208	BZASF016027	269	BZPACC20050	211	BZT8135009	174	BZTACON04	101	BZTPPO40020	193
BZALHC20060	208	BZASF020032	269	BZPACC22520	211	BZT8135013	174	BZTACON05	101	BZTPPO40025	193
BZALHC20070	208	BZASF025040	269	BZPACC22525	211	BZT8135016	174	BZTACON06	101	BZTPPO40030	193
BZALHC20080	208	BZBAESM04	108	BZPACC22530	211	BZT8135019	174	BZTACON08	101	BZTPPO40035	193
BZALHC21080	208	BZBAESM05	108	BZPACC25040	211	BZT8139013	174	BZTACON10	101	BZTPPO40040	193
BZALHC21090	208	BZBAESM06	108	BZPACC25050	211	BZT8139016	174	BZTACON12	101	BZTPPO40045	193
BZALHC21100	208	BZBAGAM04	108	BZPACC29060	211	BZT8139019	174	BZTALAM06	66	BZTPPO40050	193
BZALHC22110	208	BZBAGAM05	108	BZPACC29070	211	BZT8139025	174	BZTALAM08	66	BZTPPO40060	193
BZALHC22120	208	BZBAGAM06	108	BZPACC34040	211	BZT8139032	174	BZTALAM10	66	BZTPPO45030	193
BZALHC23130	208	BZBOCA008	245	BZPACC34050	211	BZT8142009	174	BZTAPLAME	112	BZTPPO45035	193
BZALHCB1630	208	BZBOCA010	245	BZPACC34060	211	BZT8142013	174	BZTAPLANY	112	BZTPPO45040	193
BZALHCB1740	208	BZCFBL	212	BZPACC34070	211	BZT8142016	174	BZTB05030	198	BZTPPO45045	193
BZALHCB1850	208	BZGDZ03	126	BZPACX1010	212	BZT8142019	174	BZTB05040	198	BZTPPO45050	193
BZALHCB1960	208	BZGDZ04	126	BZPACX13012	212	BZT8142025	174	BZTB05050	198	BZTPPO45060	193
BZALHCTS05	99	BZGDZ05	126	BZPACX13020	212	BZT8142032	174	BZTB06030	198	BZTPPO45070	193
BZALHCTS06	99	BZGDZ06	126	BZPACX15016	212	BZT8142038	174	BZTB06040	198	BZTPPO50030	193
BZALHCTS08	99	BZGMZ08012	212	BZPACX15025	212	BZT8148016	174	BZTB06050	198	BZTPPO50035	193
BZALRE20015	206	BZGMZ10016	212	BZPACX18030	212	BZT8148019	174	BZTB06060	198	BZTPPO50040	193
BZALRE25020	206	BZGMZ12020	212	BZPAESM04	109	BZT8148025	174	BZTB06070	198	BZTPPO50050	193
BZALRE25025	206	BZGMZ15026	212	BZPAESM05	109	BZT8148032	174	BZTB06080	198	BZTPPO50060	193
BZALRE25030	206	BZGMZ17030	212	BZPAESM06	109	BZT8148038	174	BZTB07050	198	BZTPPO50070	193
BZALRE35040	206	BZGMZ19035	212	BZPAGAM04	109	BZT8148050	174	BZTB07060	198	BZTPPO50080	193
BZALRE35050	206	BZGRB001	287	BZPAGAM05	109	BZT8148060	174	BZTB07070	198	BZTPPO50100	193
BZALRE40060	206	BZGRB010	287	BZPAGAM06	109	BZT8155025	174	BZTB08040	198	BZTPPO60040	193
BZALRE40070	206	BZGRB050	287	BZPL35025	136	BZT8155032	174	BZTB08050	198	BZTPPO60050	193
BZALRE40080	206	BZGRB060	287	BZPL35035	136	BZT8155038	174	BZTB08060	198	BZTPPO60060	193
BZALRO14025	207	BZGRB070	287	BZPL35045	136	BZT8155050	174	BZTB08070	198	BZTPPO60070	193
BZALRO16030	207	BZGRB080	287	BZPUHCL01	244	BZT8242019	175	BZTB08080	198	BZTPPO60080	193
BZALRO17040	207	BZGRB090	287	BZPUHCL02	244	BZT8242025	175	BZTB08090	198	BZTPPO60090	193
BZALRO18040	207	BZGRB100	287	BZPUHCL03	244	BZT8248025	175	BZTB08100	198	BZTPPO60100	193
BZALRO18050	207	BZGRB120	287	BZPUOCL01	245	BZT8248038	175	BZTBI0050	198	BZTPPOTS05	99
BZALRO19050	207	BZGRZ05	125	BZPUOCL02	245	BZT9650410Z	235	BZTBI0060	198	BZTPPOTS06	99
BZALRO19060	207	BZGRZ06	125	BZPUOCL03	245	BZT9650420Z	235	BZTBI0080	198	BZTPPOTS08	99
BZALRO19070	207	BZGRZ08	125	BZPUTOT01	244	BZT9650430Z	235	BZTBS10	99	BZTPTPADBE	247
BZALRO20060	207	BZGRZ10	125	BZPUTOT02	244	BZT9650510Z	235	BZTCCA05030	97	BZTPTPADBL	247
BZALRO20070	207	BZHARM03026	210	BZRECA4010	115	BZT9650520Z	235	BZTCCA05050	97	BZTPTPADCA	247
BZALRO21080	207	BZHARM04035	210	BZRECA4012	115	BZT9650525Z	235	BZTCCA06040	97	BZTPTPADCE	247
BZALRO21090	207	BZHARM05037	210	BZRECA4016	115	BZT9650530Z	235	BZTCCA06050	97	BZTPTPADGR	247
BZALRO22100	207	BZHARM06050	210	BZRECA4810	115	BZT9650620Z	235	BZTCCA06060	97	BZTPTPADHA	247
BZALRO22110	207	BZHARM08060	210	BZRECA4812	115	BZT9650630Z	235	BZTCCA06070	97	BZTPTPADNE	247
BZALRO22120	207	BZHCRM03026	210	BZRECA4814	115	BZT9650640Z	235	BZTCCA08060	97	BZTPTPADNO	247
BZALRO23130	207	BZHCRM04035	210	BZRECA4816	115	BZT9850306Z	234	BZTCCA08080	97	BZTPTPADPI	247
BZALROBI630	207	BZHCRM05037	210	BZRECA4818	115	BZT9850310Z	234	BZTCCA08100	97	BZTPTPADRO	247
BZALROBI740	207	BZHCRM06050	210	BZRENO3208	114	BZT9850316Z	234	BZTCCA08120	97	BZTPTPADSA	247
BZALROBI850	207	BZHCRM08060	210	BZRENO3210	114	BZT9850320Z	234	BZTN4S05	98	BZTREPVO550	201
BZALROBI960	207	BZHCRM10065	210	BZRENO4008	114	BZT9850330Z	234	BZTN4S06	98	BZTREPVO750	201
BZALROTS05	99	BZINCO432	110	BZRENO4010	114	BZT9850416Z	234	BZTN4S08	98	BZTRET05050	201
BZALROTS06	99	BZINCO438	110	BZRENO4012	114	BZT9850420Z	234	BZTN4S10	98	BZTRET07050	201
BZALROTS08	99	BZINCO537	110	BZRENO4016	114	BZT9850430Z	234	BZTN4S12	98	BZTSGA06	122
BZAM06060	43	BZINCO552	110	BZRENO4810	114	BZT9850510Z	234	BZTPPO25016	193	BZTUMAM03	241
BZAM06080	43	BZINCO565	110	BZRENO4812	114	BZT9850520Z	234	BZTPPO25020	193	BZTUMAM04	241
BZAM08050	43	BZINCO637	110	BZRENO4816	114	BZT9850525Z	234	BZTPPO25025	193	BZTUMAM05	241
BZAM08075	43	BZINCO652	110	BZRENO4820	114	BZT9850530Z	234	BZTPPO30016	193	BZTUMAM06	241
BZAM08090	43	BZMAE0630	325	BZRENO4824	114	BZT9850540Z	234	BZTPPO30020	193	BZTUMAM08	241
BZAM10070	43	BZMAE0825	325	BZSJZ0403	120	BZT9850610Z	234	BZTPPO30025	193	BZTUMAM10	241
BZAM10090	43	BZMAE1030	325	BZSJZ0505	120	BZT9850616Z	234	BZTPPO30030	193	BZTUMAM12	241
BZAM10120	43	BZPACCI5015	211	BZSJZ0506	120	BZT9850620Z	234	BZTPPO35016	193	BZTXBP30016	184
BZAM12090	43	BZPACCI5020	211	BZSJZ0608	120	BZT9850625Z	234	BZTPPO35020	193	BZTXBP30020	184
BZAM12110	43	BZPACCI5025	211	BZSVCL	213	BZT9850630Z	234	BZTPPO35025	193	BZTXBP30025	184
BZAM12140	43	BZPACC20025	211	BZSVCLMA	213	BZT9850640Z	234	BZTPPO35030	193	BZTXBP30030	184
BZANCLA40	112	BZPACC20030	211	BZSVNB01	213	BZT9850650Z	234	BZTPPO35035	193	BZTXBP35016	184
BZANCLA47	112	BZPACC20035	211	BZSVNB02	213	BZT9850660Z	234	BZTPPO35040	193	BZTXBP35020	184
BZASF008016	269	BZPACC20040	211	BZSVNM01	213	BZTABRIBL8	281	BZTPPO35050	193	BZTXBP35025	184
BZASF012022	269	BZPACC20045	211	BZSVNM02	213	BZTABRINE8	281	BZTPPO40016	193	BZTXBP35030	184

Ref	pág	Ref	pág	Ref	pág	Ref	pág	Ref	pág	Ref	pág
BZTXBP35035	184	BZZ98503	237	COSO20400	336	D933IM04030	228	D933IM10025	228	D933IM16090	228
BZTXBP35040	184	BZZ98504	237	COSO20450	336	D933IM04030	358	D933IM10025	358	D933IM16090	358
BZTXBP35050	184	BZZ98505	237	COSO20500	336	D933IM04035	228	D933IM10030	228	D933IM16100	228
BZTXBP40025	184	BZZ98506	237	CPAC300453	138	D933IM04035	358	D933IM10030	358	D933IM16100	358
BZTXBP40030	184	BZZ98508	237	CPAC300703	138	D933IM04040	228	D933IM10035	228	D933IM18030	228
BZTXBP40035	184	BZZ98510	237	CPCV012	138	D933IM04040	358	D933IM10035	358	D933IM18030	358
BZTXBP40040	184	BZZ98512	237	CPCV030	138	D933IM05010	228	D933IM10040	228	D933IM18040	228
BZTXBP40045	184	CABA004	108	CPMV020	138	D933IM05010	358	D933IM10040	358	D933IM18040	358
BZTXBP40050	184	CABA005	108	CPMV045	138	D933IM05016	228	D933IM10050	228	D933IM18050	228
BZTXBP40060	184	CABA006	108	CPMV090	138	D933IM05016	358	D933IM10050	358	D933IM18050	358
BZTXBP45030	184	CABA008	108	CPMV150	138	D933IM05020	228	D933IM10060	228	D933IM18060	228
BZTXBP45035	184	CABTC47	140	CPPA023	138	D933IM05020	358	D933IM10060	358	D933IM18060	358
BZTXBP45040	184	CABTC60	140	CPPA075	138	D933IM05025	228	D933IM10070	228	D933IM18070	228
BZTXBP45045	184	CAPA004	109	CPPA150	138	D933IM05025	358	D933IM10070	358	D933IM18070	358
BZTXBP45050	184	CAPA005	109	CSB0104010	316	D933IM05030	228	D933IM10080	228	D933IM18080	228
BZTXBP45060	184	CAPA006	109	CSB0108010	316	D933IM05030	358	D933IM10080	358	D933IM18080	358
BZTXBP45070	184	CAPA008	109	DI25IM04	239	D933IM05035	228	D933IM10090	228	D933IM18090	228
BZTXBP50030	184	CAQU008	81	DI25IM04	360	D933IM05035	358	D933IM10090	358	D933IM18090	358
BZTXBP50035	184	CAQU010	81	DI25IM05	239	D933IM05040	228	D933IM10100	228	D933IM18100	228
BZTXBP50040	184	CAQU012	81	DI25IM05	360	D933IM05040	358	D933IM10100	358	D933IM18100	358
BZTXBP50050	184	CAQU016	81	DI25IM06	239	D933IM05050	228	D933IM12020	228	D934IM04	236
BZTXBP50060	184	CAQU020	81	DI25IM06	360	D933IM05050	358	D933IM12020	358	D934IM04	359
BZTXBP50070	184	CAQU024	81	DI25IM08	239	D933IM06010	228	D933IM12030	228	D934IM05	236
BZTXBP50080	184	CAQU030	81	DI25IM08	360	D933IM06010	358	D933IM12030	358	D934IM05	359
BZTXBP60050	184	CFBL	212	DI25IM10	239	D933IM06016	228	D933IM12040	228	D934IM06	236
BZTXBP60060	184	CIPE1208	270	DI25IM10	360	D933IM06016	358	D933IM12040	358	D934IM06	359
BZTXBP60070	184	CIPE1708	270	DI25IM12	239	D933IM06020	228	D933IM12050	228	D934IM08	236
BZTXBP60080	184	CIPEA21708	270	DI25IM12	360	D933IM06020	358	D933IM12050	358	D934IM08	359
BZTXP30016	185	CIPEA21708	365	DI25IM14	239	D933IM06025	228	D933IM12060	228	D934IM10	236
BZTXP30020	185	CIPRI208	270	DI25IM14	360	D933IM06025	358	D933IM12060	358	D934IM10	359
BZTXP30025	185	CIPRI908	270	DI25IM16	239	D933IM06030	228	D933IM12070	228	D934IM12	236
BZTXP30030	185	CLCCS0616	308	DI25IM16	360	D933IM06030	358	D933IM12070	358	D934IM12	359
BZTXP35016	185	CLEX01	309	DI25IM18	239	D933IM06035	228	D933IM12080	228	D934IM14	236
BZTXP35020	185	CLGS1522	302	DI25IM18	360	D933IM06035	358	D933IM12080	358	D934IM14	359
BZTXP35025	185	CLPG4120	309	DI25IM20	239	D933IM06040	228	D933IM12090	228	D934IM16	236
BZTXP35030	185	CLSCI722	308	DI25IM20	360	D933IM06040	358	D933IM12090	358	D934IM16	359
BZTXP35035	185	CLTT01	309	DI25IM22	239	D933IM06050	228	D933IM12100	228	D934IM18	236
BZTXP35040	185	CMBRPOS33	128	DI25IM22	360	D933IM06050	358	D933IM12100	358	D934IM18	359
BZTXP35050	185	CMBRPOS40	128	DI25IM24	239	D933IM08016	228	D933IM14030	228	D934IM20	236
BZTXP40025	185	CMBRPOS42	128	DI25IM24	360	D933IM08016	358	D933IM14030	358	D934IM20	359
BZTXP40030	185	CMBRPOS48	128	DI27IM08	241	D933IM08020	228	D933IM14040	228	D934IM22	236
BZTXP40035	185	CMBRPOS50	128	DI27IM08	307	D933IM08020	358	D933IM14040	358	D934IM22	359
BZTXP40040	185	CMBRPOS60	128	DI27IM08	361	D933IM08025	228	D933IM14050	228	D934IM24	236
BZTXP40045	185	CMBRTEN48	128	DI27IM08	368	D933IM08025	358	D933IM14050	358	D934IM24	359
BZTXP40050	185	CMTAPON33	128	DI27IM10	241	D933IM08030	228	D933IM14060	228	D985IM04	237
BZTXP40060	185	CMTAPON40	128	DI27IM10	307	D933IM08030	358	D933IM14060	358	D985IM04	360
BZTXP45030	185	CMTAPON42	128	DI27IM10	361	D933IM08035	228	D933IM14070	228	D985IM05	237
BZTXP45035	185	CMTAPON48	128	DI27IM10	368	D933IM08035	358	D933IM14070	358	D985IM05	360
BZTXP45040	185	CMTAPON50	128	DI27IM12	241	D933IM08040	228	D933IM14080	228	D985IM06	237
BZTXP45045	185	CMTAPON60	128	DI27IM12	307	D933IM08040	358	D933IM14080	358	D985IM06	360
BZTXP45050	185	CMTAPOS33	128	DI27IM12	361	D933IM08050	228	D933IM14100	228	D985IM08	237
BZTXP45060	185	CMTAPOS40	128	DI27IM12	368	D933IM08050	358	D933IM14100	358	D985IM08	360
BZTXP45070	185	CMTAPOS42	128	D603I08016	233	D933IM08060	228	D933IM16030	228	D985IM10	237
BZTXP50030	185	CMTAPOS48	128	D603I08016	307	D933IM08060	358	D933IM16030	358	D985IM10	360
BZTXP50035	185	CMTENSOAL	129	D603I08016	359	D933IM08070	228	D933IM16040	228	D985IM12	237
BZTXP50040	185	CMTENSOTO	129	D603I08016	368	D933IM08070	358	D933IM16040	358	D985IM12	360
BZTXP50050	185	CMTENSOVE	129	D933IM04010	228	D933IM08080	228	D933IM16050	228	D985IM14	237
BZTXP50060	185	CMUNAAGUJ	128	D933IM04010	358	D933IM08080	358	D933IM16050	358	D985IM14	360
BZTXP50070	185	COAR08060	256	D933IM04016	228	D933IM08090	228	D933IM16060	228	D985IM16	237
BZTXP50080	185	COAR10060	256	D933IM04016	358	D933IM08090	358	D933IM16060	358	D985IM16	360
BZTXP60050	185	COKS08060	336	D933IM04020	228	D933IM08100	228	D933IM16070	228	D985IM18	237
BZTXP60060	185	COSO15400	336	D933IM04020	358	D933IM08100	358	D933IM16070	358	D985IM18	360
BZTXP60070	185	COSO15450	336	D933IM04025	228	D933IM10020	228	D933IM16080	228	D985IM20	237
BZTXP60080	185	COSO15500	336	D933IM04025	358	D933IM10020	358	D933IM16080	358	D985IM20	360

Ref	pág	Ref	pág	Ref	pág	Ref	pág	Ref	pág		
D9851M22	237	D12533	239	D60810035	233	D91208070	231	D93306065	226	D93316090	226
D9851M22	360	D12536	239	D60810040	233	D91208080	231	D93306070	226	D93316100	226
D9851M24	237	D12703	241	D60810045	233	D91210016	231	D93308016	226	D93316110	226
D9851M24	360	D12704	241	D60810050	233	D91210020	231	D93308020	226	D93316120	226
D6798A03	242	D12705	241	D60810060	233	D91210025	231	D93308025	226	D93318030	226
D6798A04	242	D12706	241	D60811040	233	D91210030	231	D93308030	226	D93318035	226
D6798A05	242	D12708	241	D60811045	233	D91210035	231	D93308035	226	D93318040	226
D6798A06	242	D12710	241	D60811050	233	D91210040	231	D93308040	226	D93318045	226
D6798A08	242	D12712	241	D60811060	233	D91210045	231	D93308045	226	D93318050	226
D6798A10	242	D12714	241	D60811070	233	D91210050	231	D93308050	226	D93318060	226
D6798A12	242	D12716	241	D60811080	233	D91210060	231	D93308060	226	D93318070	226
D6798A14	242	D12718	241	D60811090	233	D91210070	231	D93308070	226	D93318080	226
D6798A16	242	D12720	241	D60812040	233	D91210080	231	D93308080	226	D93318090	226
D69231M08	238	D12722	241	D60812045	233	D91210090	231	D93308090	226	D93318100	226
D69231M08	307	D12724	241	D60812050	233	D91210100	231	D93308100	226	D93318110	226
D69231M08	360	D12727	241	D60812060	233	D91212020	231	D93308110	226	D93318120	226
D69231M08	368	D12730	241	D60812070	233	D91212025	231	D93308120	226	D93320030	226
D69231M10	238	D12736	241	D60812080	233	D91212030	231	D93310016	226	D93320035	226
D69231M10	307	D93403	236	D60812090	233	D91212035	231	D93310020	226	D93320040	226
D69231M10	360	D93404	236	D60812100	233	D91212040	231	D93310025	226	D93320045	226
D69231M10	368	D93405	236	D91204008	231	D91212045	231	D93310030	226	D93320050	226
D69231M12	238	D93406	236	D91204010	231	D91212050	231	D93310035	226	D93320060	226
D69231M12	307	D93408	236	D91204012	231	D91212060	231	D93310040	226	D93320070	226
D69231M12	360	D93410	236	D91204016	231	D91212070	231	D93310045	226	D93320080	226
D69231M12	368	D93412	236	D91204020	231	D91212080	231	D93310050	226	D93320090	226
D90211M04	240	D93414	236	D91204025	231	D91212090	231	D93310060	226	D93320100	226
D90211M04	361	D93416	236	D91204030	231	D91212100	231	D93310070	226	D93320110	226
D90211M05	240	D93418	236	D91204035	231	D91212110	231	D93310080	226	D93320120	226
D90211M05	361	D93420	236	D91204040	231	D91212120	231	D93310090	226	D603905016	232
D90211M06	240	D93422	236	D91204045	231	D93304008	226	D93310100	226	D603905020	232
D90211M06	361	D93424	236	D91204050	231	D93304010	226	D93312020	226	D603905025	232
D90211M08	240	D93427	236	D91205008	231	D93304012	226	D93312025	226	D603905030	232
D90211M08	361	D93430	236	D91205010	231	D93304016	226	D93312030	226	D603905035	232
D90211M10	240	D93433	236	D91205012	231	D93304020	226	D93312035	226	D603905040	232
D90211M10	361	D93436	236	D91205016	231	D93304025	226	D93312040	226	D603905045	232
D90211M12	240	D158704	238	D91205020	231	D93304030	226	D93312045	226	D603905050	232
D90211M12	361	D158705	238	D91205025	231	D93304035	226	D93312050	226	D603905060	232
D90211M14	240	D158706	238	D91205030	231	D93304040	226	D93312060	226	D603905070	232
D90211M14	361	D158708	238	D91205035	231	D93304045	226	D93312070	226	D603905080	232
D90211M16	240	D158710	238	D91205040	231	D93304050	226	D93312080	226	D603906016	232
D90211M16	361	D158712	238	D91205045	231	D93304060	226	D93312090	226	D603906020	232
D90211M18	240	D158714	238	D91205050	231	D93305010	226	D93312100	226	D603906025	232
D90211M18	361	D158716	238	D91206010	231	D93305012	226	D93312110	226	D603906030	232
D90211M20	240	D692304	238	D91206012	231	D93305016	226	D93312120	226	D603906035	232
D90211M20	361	D692305	238	D91206016	231	D93305020	226	D93314030	226	D603906040	232
D90211M22	240	D692306	238	D91206020	231	D93305025	226	D93314035	226	D603906045	232
D90211M22	361	D692308	238	D91206025	231	D93305030	226	D93314040	226	D603906050	232
D90211M24	240	D692310	238	D91206030	231	D93305035	226	D93314045	226	D603906060	232
D90211M24	361	D692312	238	D91206035	231	D93305040	226	D93314050	226	D603906070	232
D12503	239	D692314	238	D91206040	231	D93305045	226	D93314060	226	D603906080	232
D12504	239	D692316	238	D91206045	231	D93305050	226	D93314070	226	D603906090	232
D12505	239	D902103	240	D91206050	231	D93305060	226	D93314080	226	D603906100	232
D12506	239	D902104	240	D91206060	231	D93305070	226	D93314090	226	D603906110	232
D12508	239	D902105	240	D91208010	231	D93306010	226	D93314100	226	D603906120	232
D12510	239	D902106	240	D91208012	231	D93306012	226	D93314110	226	D603906130	232
D12512	239	D902108	240	D91208016	231	D93306016	226	D93314120	226	D603906140	232
D12514	239	D902110	240	D91208020	231	D93306020	226	D93316030	226	D603906150	232
D12516	239	D902112	240	D91208025	231	D93306025	226	D93316035	226	D603908016	232
D12518	239	D902114	240	D91208030	231	D93306030	226	D93316040	226	D603908020	232
D12520	239	D902116	240	D91208035	231	D93306035	226	D93316045	226	D603908025	232
D12522	239	D902118	240	D91208040	231	D93306040	226	D93316050	226	D603908030	232
D12524	239	D902120	240	D91208045	231	D93306045	226	D93316060	226	D603908035	232
D12527	239	D902122	240	D91208050	231	D93306050	226	D93316070	226	D603908040	232
D12530	239	D902124	240	D91208060	231	D93306060	226	D93316080	226	D603908045	232

Ref	pág	Ref	pág	Ref	pág	Ref	pág	Ref	pág		
D603908050	232	D692108016	230	D931812100	229	DZ98527	237	EQA220260	81	EVH12	124
D603908060	232	D692108020	230	D931812110	229	DZ98530	237	EQA220260	349	EVH14	124
D603908070	232	D692108025	230	D931812120	229	EKMULCAN	338	EQA224300	81	EVH16	124
D603908080	232	D692108030	230	D931812130	229	EKMULFAE	338	EQA224300	349	EVH18	124
D603908090	232	D692108035	230	D931812140	229	EKMULTEN	338	EQA230330	81	EVH20	124
D603908100	232	D692108040	230	D931812150	229	EKMULAC	338	EQA230330	349	EVH22	124
D603908110	232	D692108050	230	D931814050	229	EKMULTOL	338	EQA408110	81	EVH24	124
D603908120	232	D692108060	230	D931814060	229	EKMULCAL	339	EQA408110	349	EVH27	124
D603908130	232	D692110020	230	D931814070	229	EKMULAV08	339	EQA410130	81	EVH30	124
D603908140	232	D692110025	230	D931814080	229	EKMULAV10	339	EQA410130	349	EVH36	124
D603908150	232	D692110030	230	D931814090	229	EKMULCIS	339	EQA412160	81	EVH42	124
D603910020	232	D692110035	230	D931814100	229	EKMULWCB	339	EQA412160	349	EVH48	124
D603910025	232	D692110040	230	D931814110	229	EKMULRAD	339	EQA416190	81	EVHA406	124
D603910030	232	D692110050	230	D931814120	229	EKMULROB	340	EQA416190	349	EVHA406	351
D603910035	232	D692112025	230	D931814130	229	EKMACILU	340	EQA420260	81	EVHA408	124
D603910040	232	D692112030	230	D931814140	229	EKHUEILU	340	EQA420260	349	EVHA408	351
D603910045	232	D692112035	230	D931814150	229	EKMACFTP	340	EQA424300	81	EVHA410	124
D603910050	232	D692112040	230	D931816050	229	EKHUEFTP	340	EQA424300	349	EVHA410	351
D603910060	232	D692112045	230	D931816060	229	EKMACFTL	340	EQA430330	81	EVHA412	124
D603910070	232	D692112050	230	D931816070	229	EKHUEFTL	341	EQA430330	349	EVHA412	351
D603910080	232	D692112060	230	D931816080	229	EKMACFTG	341	EQAC08110	81	EVHA414	124
D603910090	232	D931806030	229	D931816090	229	EKHUEFTG	341	EQAC10130	81	EVHA414	351
D603910100	232	D931806035	229	D931816100	229	EKMULFAP	341	EQAC10190	81	EVHA416	124
D603910110	232	D931806040	229	D931816110	229	EKMULFAL	341	EQAC12160	81	EVHA416	351
D603910120	232	D931806045	229	D931816120	229	EM100	295	EQAC12220	81	EVHA420	124
D603910130	232	D931806050	229	D931816130	229	EM100	366	EQAC16190	81	EVHA420	351
D603910140	232	D931806060	229	D931816140	229	EM145	295	EQAC16250	81	EVHA424	124
D603910150	232	D931806070	229	D931816150	229	EM145	366	EQAC20260	81	EVHA424	351
D603910160	232	D931808030	229	D931818060	229	EM190	295	EQAC20350	81	EVM06	124
D603910180	232	D931808035	229	D931818070	229	EM190	366	EQAC24300	81	EVM08	124
D603910200	232	D931808040	229	D931818080	229	EMPTC45	140	EQAC24380	81	EVM10	124
D603912030	232	D931808045	229	D931818090	229	EMPTC47	140	EQAC30330	81	EVM12	124
D603912035	232	D931808050	229	D931818100	229	EMPTC60	140	ESDA208060	329	EVM14	124
D603912040	232	D931808060	229	D931818110	229	EMPX4121	299	ESDA208060	374	EVM16	124
D603912045	232	D931808070	229	D931818120	229	EMPX54115	304	ESDA210060	329	EVM18	124
D603912050	232	D931808080	229	D931818130	229	EMPXSD4115	304	ESDA210060	374	EVM20	124
D603912060	232	D931808090	229	D931818140	229	EMPXSD4115	367	ESDR06040	329	EVM22	124
D603912070	232	D931808100	229	D931818150	229	EMX1302	298	ESDR06050	329	EVM24	124
D603912080	232	D931808110	229	D931820060	229	EMX4502	298	ESDR06060	329	EVM27	124
D603912100	232	D931808120	229	D931820070	229	EMX9002	298	ESDR06070	329	EVM30	124
D603912120	232	D931808130	229	D931820080	229	EMX9004	298	ESDR06080	329	EVM33	124
D603912140	232	D931808140	229	D931820090	229	EMZ00	295	ESDR08050	329	EVM36	124
D603912160	232	D931808150	229	D931820100	229	EMZ45	295	ESDR08060	329	EVM42	124
D603912180	232	D931810035	229	D931820110	229	EMZ90	295	ESDR08070	329	EVM48	124
D603912200	232	D931810040	229	D931820120	229	EPS6072	71	ESDR08080	329	EVMA406	124
D603912220	232	D931810045	229	D931820130	229	EPS6092	71	ESDR08090	329	EVMA406	352
D603912240	232	D931810050	229	D931820140	229	EPS6112	71	ESDR08100	329	EVMA408	124
D603912260	232	D931810060	229	D931820150	229	EPS6132	71	ESDR08110	329	EVMA408	352
D603912280	232	D931810070	229	DOMTA10	45	EPS6152	71	ESDR08120	329	EVMA410	124
D603912300	232	D931810080	229	DOMTA20	45	EPS6182	71	ESDR08130	329	EVMA410	352
D692105010	230	D931810090	229	DOTFY0812	52	EQ8808110	81	ESDR10080	329	EVMA412	124
D692105012	230	D931810100	229	DZ98503	237	EQ8810130	81	ESDR10100	329	EVMA412	352
D692105016	230	D931810110	229	DZ98504	237	EQ8812160	81	ESDR10110	329	EVMA414	124
D692105020	230	D931810120	229	DZ98505	237	EQ8816190	81	ESDR10120	329	EVMA414	352
D692105025	230	D931810130	229	DZ98506	237	EQ8820260	81	ESDR10130	329	EVMA416	124
D692105030	230	D931810140	229	DZ98508	237	EQ8824300	81	ESDR10140	329	EVMA416	352
D692106010	230	D931810150	229	DZ98510	237	EQA208110	81	ESDR10150	329	EVMA420	124
D692106012	230	D931812040	229	DZ98512	237	EQA208110	349	ESDR10180	329	EVMA420	352
D692106016	230	D931812045	229	DZ98514	237	EQA210130	81	ESDR10200	329	EVMA424	124
D692106020	230	D931812050	229	DZ98516	237	EQA210130	349	ESTRINV40N	200	EVMA424	352
D692106025	230	D931812060	229	DZ98518	237	EQA212160	81	ESTRINV40Z	200	EXHBM06	65
D692106030	230	D931812070	229	DZ98520	237	EQA212160	349	EVH06	124	EXHBM08	65
D692106035	230	D931812080	229	DZ98522	237	EQA216190	81	EVH08	124	EXHBM08C	65
D692108012	230	D931812090	229	DZ98524	237	EQA216190	349	EVH10	124	EXHBM10	65

Ref	pág	Ref	pág	Ref	pág	Ref	pág	Ref	pág		
EXHBM10C	65	FPCGD1612	146	GDA415	352	GOANI5B	132	GRBL050	287	GSZ0545	127
EXHBM12	65	FPCGD1912	146	GDZ03	126	GOANI8B	132	GRBL060	287	GSZ0655	127
EXHBM12C	65	FPCL0816	145	GDZ04	126	GOAN20B	132	GRBL070	287	GSZ0765	127
EXHBM16	65	FPCL0819	145	GDZ05	126	GPG3M271812	292	GRBL080	287	GSZ0875	127
EXHBM20	65	FPCL0825	145	GDZ06	126	GPG3M283018	292	GRBL090	287	GSZ1010	127
EXHSDSM06	65	FPCL0827	145	GDZ08	126	GPG271812	292	GRBL100	287	HARM03026	210
EXHSDSM08	65	FPCL0832	145	GDZ10	126	GPG283018	292	GRBL120	287	HARM04035	210
EXHSDSM08C	65	FPCL0838	145	GDZ12	126	GPG351312	292	GRBL140	287	HARM05037	210
EXHSDSM10	65	FPCL0844	145	GDZ13	126	GPG384020	292	GRNATTV	287	HARM06050	210
EXHSDSM10C	65	FPCL0851	145	GDZ15	126	GPG402015	292	GRNE060	287	HARM08060	210
EXHSDSM12	65	FPCL0857	145	GDZ18	126	GPI271812	292	GRNE070	287	HCM06	65
EXHSDSM12C	65	FPCL0864	145	GDZ20	126	GPI271812	365	GRNE080	287	HCM08	65
FG60BAT	151	FPCL0870	145	GDZ24	126	GPI283015	292	GRNE090	287	HCM10	65
FG60CAR	151	FPCL2212	146	GIA404	127	GPI283015	365	GRNE100	287	HCRM03026	210
FG60GAS	151	FPCL2712	146	GIA404	352	GPI384020	292	GRNE120	287	HCRM04035	210
FG60GUN	148	FPCL3212	146	GIA405	127	GPI384020	365	GRZ05	125	HCRM05037	210
FG60GUNEL	148	FPCL3712	146	GIA405	352	GPO351515	293	GRZ06	125	HCRM06050	210
FGABRA15	150	FGIA4212	146	GIA406	127	GPO357510	293	GRZ08	125	HCRM08060	210
FGABRA20	150	FPCL4712	146	GIA406	352	GPP271812	292	GRZ10	125	HCRM10065	210
FGABRA25	150	FPCLD2212	147	GIA408	127	GPV251120	292	GRZ11	125	HCRM12075	210
FGARAM25	149	FPCLD2712	147	GIA408	352	GPVD4162012	304	GRZ12	125	HE65032	54
FGARAM25SEP	150	FPCLD3212	147	GIA410	127	GPX2M412120	296	GRZ14	125	HE65045	54
FGBASEGR	150	FPCLD3712	147	GIA410	352	GPX2M414120	296	GRZ16	125	HE65057	54
FGBASENE	150	FPCLD4212	147	GIA412	127	GPX412115	296	GRZ18	125	HE65070	54
FGCAEL	151	FPCLD4712	147	GIA412	352	GPX412120	296	GRZ20	125	HE65080	54
FGCL15	149	FPCR0812	146	GIA414	127	GPX412125	296	GRZ22	125	HE65100	54
FGCL20	149	FPCR0822	146	GIA414	352	GPX414115	296	GRZ25	125	HE65115	54
FGCL25	149	FPCR0827	146	GIA416	127	GPX414120	296	GRZ28	125	HE65125	54
FGCL30	149	FPCR0827	146	GIA416	352	GPX414125	296	GRZ32	125	HE65150	54
FGCL35	149	FPCRAM	144	GIA416	352	GPXS4115012	303	GRZ36	125	HE65180	54
FGCL40	149	FPCRM80812	146	GIZ05	126	GPXS4115125	303	GRZ38	125	HE65200	54
FGCLCAR40	151	FPCRM80827	146	GIZ06	126	GPXS4115187	303	GRZ42	125	HE1665032	54
FGCLCAR40	151	FPCRRO	144	GIZ08	126	GPXS4115250	303	GRZ45	125	HE1665045	54
FGCLH15	149	FPCT3212	147	GIZ10	126	GPXS4115362	303	GRZ50	125	HE1665057	54
FGCLH17	149	FPP3VE	144	GIZ11	126	GPXS4115512	303	GRZ56	125	HE1665070	54
FGCLH19	149	FPP4AM	144	GIZ12	126	GPZ201010	292	GRZ63	125	HE1665080	54
FGCLH22	149	FPP5RO	144	GIZ14	126	GPZ250808	292	CSPI040065	312	HE1665100	54
FGCLH27	149	FPP1081613	146	GIZ16	126	GRA404	125	CSPI040065	370	HE1665115	54
FGCLH32	149	FPPISCL08	147	GIZ20	126	GRA404	352	CSPI090115	312	HE1665125	54
FGIMAN	151	FPPISCL12	147	GIZ22	126	GRA404	352	CSPI090115	370	HE1665150	54
FGPLET	150	FPPISCM12	147	GIZ25	126	GRA405	125	GSTC040080	312	HE1665180	54
FI63110	162	FPPISCT12	147	GIZ28	126	GRA405	352	GSTC040080	369	HE1665200	54
FI63115	162	FPPISPL08	147	GIZ32	126	GRA406	125	GSTC040801	312	HEA4M06	63
FI63120	162	GAFOM06Z	326	GIZ36	126	GRA406	352	GSTC040801	369	HEA4M06	347
FI63125	162	GAFOM08Z	326	GLO351515	293	GRA408	125	GSTC040810	312	HEA4M08	63
FI63130	162	GAFOM10Z	326	GLO357510	293	GRA408	352	GSTC040810	369	HEA4M08	347
FI63150	162	GAFOM12Z	326	GMA030	303	GRA410	125	GSTC080120	312	HEA4M10	63
FI63160	162	GAFOM16Z	326	GMA035	303	GRA410	352	GSTC080120	369	HEA4M10	347
FICAA080	286	GDA402	126	GMA040	303	GRA412	125	GSTC081201	312	HEA4M12	63
FICAA080	286	GDA402	352	GMN030	303	GRA412	352	GSTC081201	369	HEA4M12	347
FICAA080	286	GDA403	126	GMN035	303	GRA414	125	GSTC081210	312	HEA4M16	63
FICAA080	286	GDA403	352	GMN040	303	GRA414	352	GSTC081210	369	HEA4M16	347
FICAPD160	286	GDA404	126	GMZ08012	212	GRA416	125	GSTP075100	312	HEA4M20	63
FICAPD160	286	GDA404	352	GMZ10016	212	GRA416	352	GSTP075100	370	HEA4M20	347
FICAPS080	286	GDA405	126	GMZ12020	212	GRA419	125	GSTP120145	312	HEC4M06	63
FP08GUN	144	GDA405	352	GMZ15026	212	GRA419	352	GSTP120145	370	HEC4M06	347
FP12GUN	144	GDA406	126	GMZ17030	212	GRA425	125	GSTU040055	312	HEC4M08	63
FP12GUN	144	GDA406	352	GMZ19035	212	GRA425	352	GSTU040055	370	HEC4M08	347
FPAM0837	145	GDA408	126	GOAN03B	132	GRBL001	287	GSTU040501	312	HEC4M10	63
FPAM0837	145	GDA408	352	GOAN05B	132	GRBL002	287	GSTU040501	370	HEC4M10	347
FPAM0851	145	GDA408	126	GOAN05M	132	GRBL003	287	GSTU040510	312	HEC4M12	63
FPAM0851	145	GDA408	352	GOAN08B	132	GRBL010	287	GSTU040510	370	HEC4M12	347
FPAP085166	145	GDA410	126	GOAN08M	132	GRBL020	287	CSZ0325	127	HEC4M12	347
FPC303708	145	GDA410	352	GOANI0B	132	GRBL030	287	CSZ0435	127	HEC4M12	347
FPC304708	145	GDA412	126	GOANI2B	132	GRBL040	287			HEC4M12	347
FPC304708	145	GDA412	352							HEC4M12	347
FPCG0816	145	GDA415	126							HEC4M12	347
FPCG0819	145									HEC4M12	347
FPCG1612	146									HEC4M12	347
FPCG1912	146									HEC4M12	347

Ref	pág	Ref	pág	Ref	pág	Ref	pág	Ref	pág		
HECLOM10	63	INCO565	110	KCGPX0240	317	KTGPX0230	318	MARI0830	326	MI20120	344
HECLOM12	63	INCO580	110	KCGPX0330	317	KTGPX0235	318	MARI0830	373	MI20170	42
HECLOM12D	63	INCO637	110	KCGPX0335	317	KTGPX0240	318	MARI030	326	MI20170	344
HECLOM16	63	INCO652	110	KCGPX0340	317	KTGPX0330	318	MARI030	373	MI20220	42
HEHCM08	64	INCO665	110	KCPXA02AM	317	KTGPX0335	318	MCMA025	133	MI20220	344
HEHCM10	64	INCO680	110	KCPXA03AM	317	KTGPX0340	318	MCMA030	133	MIA406045	42
HEHCM12	64	INHE837	110	KCPXA0230	317	KTPSC02AM	318	MCMA040	133	MIA406045	345
HEHCSDS08	64	INHE855	110	KCPXA0235	317	KTPSC02AM	373	MCOV025	133	MIA406060	42
HEHCSDS10	64	INHE865	110	KCPXA0240	317	KTPSC03AM	318	MCOV030	133	MIA406060	345
HEHCSDS12	64	INPINZANI	111	KCPXA0330	317	KTPSC03AM	373	MCOV040	133	MIA406080	42
HEHOM06	63	INPISANIN	111	KCPXA0335	317	KTPSC0230	318	MCPR05250	133	MIA406080	345
HEHOM08	63	INSI421	110	KCPXA0340	317	KTPSC0230	373	MCPR05400	133	MIA408050	42
HEHOM10	63	INSI432	110	KCPSC02AM	317	KTPSC0235	318	MCPR05600	133	MIA408050	345
HEHOM12	63	INSI438	110	KCPSC03AM	317	KTPSC0235	373	MEDUB06	101	MIA408075	42
HEHOM12D	63	INSI537	110	KCPSC0230	317	KTPSC0240	318	MEDUB07	101	MIA408075	345
HEHOM16	63	INSI552	110	KCPSC0235	317	KTPSC0240	373	MEDUB08	101	MIA408090	42
HEHOM20	63	INSI565	110	KCPSC0240	317	KTPSC0330	318	MEDUB10	101	MIA408090	345
HEHOSDS06	64	INSI637	110	KCPSC0330	317	KTPSC0330	373	MI06045	42	MIA408115	42
HEHOSDS08	64	INSI652	110	KCPSC0335	317	KTPSC0335	318	MI06045	344	MIA408115	345
HEHOSDS10	64	INSI665	110	KCPSC0340	317	KTPSC0335	373	MI06060	42	MIA410070	42
HEHOSDS12	64	INSI865	110	KCPSD01AM	317	KTPSC0340	318	MI06060	344	MIA410070	345
HENOM06	64	INVA27050	200	KCPSD0130	317	KTPSC0340	373	MI06080	42	MIA410090	42
HENOM08	64	INVA27050	357	KCPSD0135	317	KTPSE02AM	318	MI06080	344	MIA410090	345
HENOM10	64	INVA27060	200	KCPSD0140	317	KTPSE02AM	372	MI06120	42	MIA410120	42
HENOM12	64	INVA27060	357	KFRSC3050	302	KTPSE03AM	318	MI06120	344	MIA410120	345
HENOM16	64	INVA27070	200	KFRSC3050	366	KTPSE03AM	372	MI06140	42	MIA410150	42
HENOM20	64	INVA27070	357	KFRSCN3050	302	KTPSE0230	318	MI06140	344	MIA410150	345
HENSM08	64	INVA27080	200	KFRSCN3050	366	KTPSE0230	372	MI06160	42	MIA4102075	42
HENSM10	64	INVA27080	357	KFRSS0850	302	KTPSE0235	318	MI06160	344	MIA412075	345
HENSM12	64	INVN6040	200	KFRSS0850	366	KTPSE0235	372	MI06170	42	MIA412090	42
HENSM16	64	INVN6050	200	KFRSS0870	302	KTPSE0240	318	MI06170	344	MIA412090	345
HOCRM647	139	INVN6060	200	KFRSS0870	366	KTPSE0240	372	MI06180	42	MIA412110	42
HOCRM660	139	INVN6070	200	KFSAU10160	311	KTPSE0330	318	MI06180	344	MIA412110	345
HOCUM647	139	INVN7030	200	KFSAU10160	369	KTPSE0330	372	MI08050	42	MIA412140	42
HP75072	53	INVN7040	200	KFSAU10200	311	KTPSE0335	318	MI08050	344	MIA412140	345
HP75092	53	INVN7050	200	KFSAU10200	369	KTPSE0335	372	MI08075	42	MIA416090	42
HP75112	53	INVN7060	200	KFSFCM0820	308	KTPSE0340	318	MI08075	344	MIA416090	345
HP75132	53	INVN7070	200	KFSFIM08	308	KTPSE0340	372	MI08090	42	MIA416145	42
HP75152	53	INVN7080	200	KFSFIM08	368	LSMOES06070	80	MI08090	344	MIA416145	345
HP75182	53	INVN7090	200	KFSFLM08	308	LSMOES08110	80	MI08115	42	MIA416170	42
HPZ75052	53	INVZ6040	199	KFSMAI0200	311	LSMOES10115	80	MI08115	344	MIA416170	345
HPZ75062	53	INVZ6050	199	KFSMAI0200	369	LSMOES12110	80	MI10070	42	MIA420120	42
HPZ75072	53	INVZ6060	199	KFSMAI0250	311	MABM6018	139	MI10070	344	MIA420120	345
HPZ75082	53	INVZ6070	199	KFSMAI0250	369	MAE0620	325	MI10090	42	MIA420170	42
HPZ75092	53	INVZ7030	199	KFSMAI2300	311	MAE0630	325	MI10090	344	MIA420170	345
HPZ75102	53	INVZ7040	199	KFSMAI2300	369	MAE0825	325	MI10120	42	MIA420220	42
HPZ75112	53	INVZ7050	199	KFSMAI2350	311	MAEI030	325	MI10120	344	MIA420220	345
HPZ75122	53	INVZ7060	199	KFSMAI2350	369	MAEI235	325	MI10150	42	MLTPPOP101	214
HPZ75132	53	INVZ7070	199	KFSMAI02002	311	MAEI650	325	MI10150	344	MLTBOP101	214
HPZ75152	53	INVZ7080	199	KFSMAI02002	369	MAE2060	325	MI12075	42	MLTPPOT101	215
HPZ75182	53	INVZ7090	199	KFSMAI02010	311	MAMH0610	326	MI12075	344	MLTPPOT201	215
HPZ75212	53	INVZ7105	199	KFSMAI02010	369	MAMH0620	326	MI12090	42	MLTPPOT301	215
HPZ75252	53	INVZ7120	199	KFSMAI02502	311	MAMH0630	326	MI12090	344	MLMULT101	215
HR75072	54	INVZ7140	199	KFSMAI02502	369	MAMH0640	326	MI12110	42	MLMULT201	215
HR75092	54	INVZ7165	199	KFSMAI02510	311	MAMH0650	326	MI12110	344	MLMULT301	215
HR75112	54	INVZ7205	199	KFSMAI02510	369	MAR0420	325	MI12140	42	MLPLAT101	215
HR75132	54	KCGPD01AM	318	KFSRV10250	311	MAR0620	325	MI12140	344	MLPLAT201	215
INCO421	110	KCGPD0130	318	KFSRV10250	369	MAR0630	325	MI16090	42	MLPLAT301	215
INCO432	110	KCGPD0135	318	KFSRV12350	311	MAR0825	325	MI16090	344	MOBOMBA	80
INCO438	110	KCGPD0140	318	KFSRV12350	369	MAR0830	325	MI16145	42	MOES06070	80
INCO446	110	KCGPX02AM	317	KIT MO-PS+	78	MARI030	325	MI16145	344	MOES08110	80
INCO459	110	KCGPX03AM	317	KITINPIN01	111	MARI235	325	MI16170	42	MOES10115	80
INCO537	110	KCGPX0230	317	KTGPX02AM	318	MARI650	325	MI16170	344	MOES12110	80
INCO552	110	KCGPX0235	317	KTGPX03AM	318	MAR5322	325	MI20120	42	MOP300	77

Ref	pág	Ref	pág	Ref	pág	Ref	pág	Ref	pág		
MOP410	77	MQBS11	127	OMEM06	139	PACP22525	211	PLCAZ4216	137	PSEA603625	305
MOPCI85	80	MQBS12	127	OMEM06	149	PACP22530	211	PLCAZ4219	137	PSEA604400	305
MOPCI85	314	MSCAHT	86	P50M413Z	180	PACP25040	211	PLCAZ4225	137	PSEA604800	305
MOPISNEU	80	MSCATP	86	P50M416	180	PACP25050	211	PLCAZ4232	137	PSEC410125	306
MOPISP3385	80	MSISG01	83	P50M416Z	180	PACP29050	211	PLCAZ4241	137	PSEC410200	306
MOPISP3585	80	MSISG01	316	P50M419	180	PACP29060	211	PLCAZ4251	137	PSEC411250	306
MOPISPR	80	MSISG05	83	P50M419Z	180	PACP29070	211	PLEP35025	136	PSEC411875	306
MOPISPUR6	80	MSISG05	316	P50M425	180	PACP34030	211	PLEP35035	136	PSEC412500	306
MOPISSI	80	MSIST01	83	P50M425Z	180	PACP34040	211	PLRA3925	137	PSEC413625	306
MOPISTO	80	MSIST01	316	P50M432	180	PACP34050	211	PLRA3935	137	PSEC414400	306
MOPSP300	78	MSIST05	83	P50M432Z	180	PACP34060	211	PLRA3945	137	PSEC414800	306
MOPSP300EP	78	MSIST05	316	P50M438	180	PACP34070	211	PLRA3955	137	PSECB410125	306
MOPSP410	78	MSPRBR290	83	P70TPBL	180	PACP34080	211	PLRA4835	137	PSECB410200	306
MOPSP300	78	MSPRC290	83	P70TPNG	180	PAESM04	109	PLTR3525	137	PSECUN200	306
MOPSP410	78	MSPRM290	83	PI00KOM10	181	PAESM05	109	PLTR3535	137	PSECUNT200	306
MOPSU300	77	MSPRN290	83	PI00VEK	181	PAESM06	109	PLTR3545	137	PSECUNT200	367
MOPSU410	77	MSSF290	83	PI00VEK10	181	PAESM08	109	PMO1012	313	PSEUN060200	305
MOPU300	77	MSTR290	83	PI00VEK13	181	PAEXM08	256	PMO1012	370	PSEUNT60200	305
MOPU410	77	NAC6035	67	PI03925Z	179	PAGAM10	256	PMOD101202	313	PSEUNT60200	367
MOPUP300	77	NAC6040	67	PI03930Z	179	PAGAM04	109	PMOD101202	371	PSL55075	161
MOPUR30385	79	NAC6045	67	PI03938Z	179	PAGAM05	109	PMOD101210	313	PSL55085	161
MOPUR30585	79	NAC6050	67	PI03945Z	179	PAGAM06	109	PMOD101210	371	PSL55105	161
MOPURE600	79	NAC6055	67	P204316Z	179	PAGAM08	109	PMOK101202	313	PSL55130	161
MORCANU	80	NAC6065	67	P204319Z	179	PCU0005	140	PMOK101202	371	PSL55150	161
MORCAPU	80	NAC6085	67	P204322Z	179	PCU0006	140	PMOK101210	313	PSL55175	161
MORCEPKIT	80	NAC6110	67	P204325	179	PFA4M0800	330	PMOK101210	371	PSL55200	161
MOTLI6330	80	NAE6045	67	P204325Z	179	PFA4M0800	374	PMOL1012	313	PSL55230	161
MOTLI6330	314	NAE6050	67	P204330	179	PFA4M0810	330	PMOLK101202	313	PSL1655075	161
MOTM12100	80	NAE6055	67	P204330Z	179	PFA4M0810	374	PMOLK101202	371	PSL1655085	161
MOTM16100	80	NAF65810	67	P204338	179	PFA4M1000	330	PMOLK101210	313	PSL1655105	161
MOTM22100	80	NAF66310	67	P204338Z	179	PFA4M1000	374	PMOLK101210	371	PSL1655130	161
MOTNI2050	80	NAG6055	67	P204345	179	PFZNM0800	330	PRX01	297	PSL1655150	161
MOTNI2080	80	NAR6055	67	P204345Z	179	PFZNM0810	330	PS55060	160	PSL1655175	161
MOTNI5085	80	NBP3513	170	P204355	179	PFZNM1000	330	PS55082	160	PSL1655200	161
MOTNI5130	80	NBP3516	170	P204355Z	179	PGI2718	295	PS55098	160	PSL1655230	161
MOTN20085	80	NBP3519	170	P304825	179	PGI2718	366	PS55115	160	PSL1955255	161
MOTRO08	80	NBP3525	170	P304838	179	PGI2830	295	PS55130	160	PSL1955255	354
MOTRO10	80	NBP4216	170	P403913Z	180	PGI2830	366	PS55150	160	PSL1955285	161
MOTRO12	80	NBP4219	170	P403916	179	PGI3840	295	PS55180	160	PSL1955285	354
MOV300	78	NBP4225	170	P403916Z	180	PGI3840	366	PSI655060	160	PST1655060	160
MOV410	78	NBP4232	170	P403919	179	PGSA26	302	PSI655082	160	PST1655060	314
MOVH300	79	NBP4238	170	P403919Z	180	PGSN26	303	PSI655098	160	PST1655060	354
MOVH410	79	NBP4825	170	P403925	179	PGX4121	300	PSI655115	160	PST1655060	371
MOVHW300	79	NBP4832	170	P403925Z	180	PGX4141	300	PSI655130	160	PST1655082	160
MOVHW410	79	NBP4838	170	P403932	179	PGZ2718	295	PSI655150	160	PST1655082	314
MOVVF300	78	NBP4850	170	P403932Z	180	PGZ2830	295	PSI655180	160	PST1655082	354
MOVVF410	78	NBR3509	167	P403938	179	PGZ3840	295	PSI955195	160	PST1655082	371
MQB04	127	NBR3513	167	P403938Z	180	PL35019	136	PSI955195	354	PST1655098	160
MQB05	127	NBR3516	167	P704855	180	PL35025	136	PSI955230	160	PST1655098	314
MQB06	127	NBR3519	167	P704865	180	PL35035	136	PSI955230	354	PST1655098	354
MQB07	127	NBR4213	167	P704880	180	PL35045	136	PSAA0400	304	PST1655098	371
MQB08	127	NBR4216	167	P704895	180	PL35055	136	PSAA1250	304	PST1655115	160
MQB09	127	NBR4219	167	P903510	181	PL39025	136	PSAA1875	304	PST1655115	314
MQB10	127	NBR4225	167	P904017	181	PL39035	136	PSAA2500	304	PST1655115	354
MQB11	127	NBR4232	167	PACCI5015	211	PL39045	136	PSAA3625	304	PST1655115	371
MQB12	127	NBR4238	167	PACCI5020	211	PL39055	136	PSAA4400	304	PSTLI655075	161
MQB14	127	NBR4816	167	PACCI5025	211	PL42070	136	PSAA4800	304	PSTLI655075	314
MQB15	127	NBR4819	167	PACCI20025	211	PL42080	136	PSAAV0150	305	PSTLI655075	354
MQBS04	127	NBR4825	167	PACCI20030	211	PL48090	136	PSAUN200	304	PSTLI655075	372
MQBS06	127	NBR4832	167	PACCI20035	211	PL48100	136	PSAUNT200	305	PSTLI655085	161
MQBS07	127	NBR4838	167	PACCI20040	211	PL48110	136	PSAUNT200	367	PSTLI655085	314
MQBS08	127	NBR4845	167	PACCI20045	211	PL48120	136	PSEA601250	305	PSTLI655085	354
MQBS09	127	NBR4850	167	PACCI20050	211	PL48130	136	PSEA601875	305	PSTLI655085	372
MQBS10	127	NUXSM0841	311	PACP22520	211	PLCAZ4213	137	PSEA602500	305	PSTLI655105	161

Ref	pág	Ref	pág	Ref	pág	Ref	pág	Ref	pág		
PSTLI655105	314	PUSC750	87	REIN4812	350	RENO6016	114	SCED090904	218	SJA42103	120
PSTLI655105	354	PUSP750	87	REIN4816	115	RENO6018	114	SCED090906	218	SJA42103	350
PSTLI655105	372	PUTO010	244	REIN4816	350	RENO6025	114	SCED101009	218	SJA42305	120
PSTLI655130	161	PUTO015	244	REIN4818	115	RESX300	297	SCEI040402	218	SJA42305	350
PSTLI655130	314	PUTO020	244	REIN4818	350	RESX550	297	SCEI040404	218	SJA42606	120
PSTLI655130	354	PUTO025	244	REIN4820	115	RETE5220	315	SCEI040406	218	SJA42606	350
PSTLI655130	372	PUTO030	244	REIN4820	350	RMEX01	118	SCEI050504	218	SJA43008	120
PTBRI0035	222	PUTO040	244	RENO3206	114	RMMA01	118	SCEI060604	218	SJA43008	350
PTBRI3355	222	PUTP750	87	RENO3208	114	RMPA01	118	SCEI060606	218	SJA43410	120
PTEM18040	222	PUTPR750	88	RENO3208BBL	115	RSA23509	171	SCEI060608	218	SJA43410	350
PTETI69845	222	PUZ2718	295	RENO3208NE	116	RSA23509	355	SCEI070704	218	SJA43611	120
PTOB05015	222	PUZ3840	295	RENO3210	114	RSA24213	171	SCEI080808	218	SJA43611	350
PTOB06015	222	RAFEM145	333	RENO3210BL	115	RSA24213	355	SCEI101004	218	SJA44414	120
PTOB08015	222	RAFEM175	333	RENO3210NE	116	RSA24216	171	SCEI101010	218	SJA44414	350
PTOB10015	222	RAFIN100	332	RENO3212	114	RSA24216	355	SCEM081240	220	SJA45016	120
PTOB12020	222	RAFRE095	332	RENO3212BL	115	RSA24219	171	SCEM101640	220	SJA45016	350
PTTO30716	222	RAPES032	333	RENO3212NE	116	RSA24219	355	SCER302525	220	SJA45418	120
PTTT111430	222	RARAY032	333	RENO3214	114	RSA24816	171	SCER392822	220	SJA45418	350
PTUNI2038	222	RARO100	333	RENO3216	114	RSA24816	355	SCGAI00404	219	SJA46122	120
PTUN16038	222	RATRC095	332	RENO3218	114	RSA24819	171	SCGZ704025	221	SJA46122	350
PTUN20060	222	RATRI095	332	RENO4006	114	RSA24819	355	SLCLZ354030	221	SJA46525	120
PTUN20080	222	RECA4008	115	RENO4008	114	RSA24825	171	SCLD040606	218	SJA46525	350
PTUN24060	222	RECA4010	115	RENO4008BBL	115	RSA24825	355	SCLD060806	218	SJO0502	120
PTUN24080	222	RECA4012	115	RENO4008NE	116	RSZ3509	171	SCMZ272715	221	SJO0503	120
PUCA01	90	RECA4016	115	RENO4010	114	RSZ3513	171	SCMZ323215	221	SJO0604	120
PUCL500	89	RECA4810	115	RENO4010BL	115	RSZ3516	171	SCMZ404015	221	SJO0605	120
PUCUC01	245	RECA4812	115	RENO4010NE	116	RSZ4213	171	SCMZ505015	221	SJO0606	120
PUCUC02	245	RECA4814	115	RENO4012	114	RSZ4216	171	SCMZ606018	221	SJPD0402	121
PUCUC03	245	RECA4816	115	RENO4012BL	115	RSZ4219	171	SCMZ808018	221	SJPD0403	121
PUCUL01	245	RECA4818	115	RENO4012NE	116	RSZ4225	171	SCOB020214	220	SJPD0504	121
PUCUL02	245	REFL4012	116	RENO4014	114	RSZ4232	171	SCOB030314	220	SJPD0605	121
PUCUL03	245	REFL4014	116	RENO4014BL	115	RSZ4813	171	SCOB040415	220	SJPD0606	121
PUEP750	89	REFL4016	116	RENO4014NE	116	RSZ4816	171	SCOB050515	220	SJPD0808	121
PUF750	88	REFL4018	116	RENO4016	114	RSZ4819	171	SCOB060618	220	SJPD40403	121
PUF750	88	REFL4020	116	RENO4018	114	RSZ4825	171	SCOB070718	220	SJPD40403	350
PUOXBITC10	244	REFL4025	116	RENO4020	114	RSZ4832	171	SCOB090920	220	SJPD40504	121
PUOXBITC15	244	REFL4814	116	RENO4025	114	RSZ4838	171	SCOB101020	220	SJPD40504	350
PUOXBITC20	244	REFL4816	116	RENO4030	114	RTX01	299	SCOB121222	220	SJPD40605	121
PUOXBITC25	244	REFL4818	116	RENO4035	114	SACI06080	335	SCOB151525	220	SJPD40605	350
PUOXBITC30	244	REFL4824	116	RENO4806	114	SACI06080	374	SCPD107530	221	SJPD40606	121
PUOXBITC40	244	REFL4830	116	RENO4808	114	SAIL06080	334	SCPD128035	221	SJPD40606	350
PUOXBITL10	244	REFL4835	116	RENO4810	114	SAIL06080	374	SCREZ357565	221	SJPS0402	121
PUOXBITL15	244	REFL4840	116	RENO4810BL	115	SALH08100	334	SCRFO70605	219	SJPS0403	121
PUOXBITL20	244	REFL4845	116	RENO4810NE	116	SALH10120	334	SCRFO70705	219	SJPS0504	121
PUOXBITL25	244	REFL4850	116	RENO4812	114	SALN08100	334	SCRFO90906	219	SJPS0605	121
PUOXBITL30	244	REIN3206	115	RENO4812BL	115	SALN10120	334	SCRFI01009	219	SJPS0606	121
PUOXBITL40	244	REIN3206	350	RENO4812NE	116	SATEA0865	335	SCRFI51506	219	SJPSA40403	121
PUPHC01	244	REIN3208	115	RENO4814	114	SATEA1075	335	SCRG090505	219	SJPSA40403	350
PUPHC02	244	REIN3208	350	RENO4814BL	115	SATEB0860	335	SCRG090508	219	SJPSA40504	121
PUPHC03	244	REIN3212	115	RENO4814NE	116	SATEB1080	335	SCRX090	299	SJPSA40504	350
PUPHL01	244	REIN3212	350	RENO4816	114	SAWH06070	335	SEACRB280	86	SJPSA40605	121
PUPHL02	244	REIN3215	115	RENO4816BL	115	SAWHM06060	335	SEACRG280	86	SJPSA40605	350
PUPHL03	244	REIN3215	350	RENO4816NE	116	SAWL05080	334	SIPRB280	85	SJPSA40606	121
PUPI01	90	REIN4008	115	RENO4818	114	SAWZ05080	334	SIPRG280	85	SJPSA40606	350
PUPI02	90	REIN4008	350	RENO4820	114	SCAS3317DR	219	SIPRM280	85	SJZ0403	120
PUPM014	246	REIN4010	115	RENO4822	114	SCAS3317IZ	219	SIPRN280	85	SJZ0505	120
PUPM1014	246	REIN4010	350	RENO4824	114	SCCDZ402575	220	SIPRSB280	85	SJZ0506	120
PUPM1014	361	REIN4012	115	RENO4826	114	SCCE200404	219	SIPRST280	85	SJZ0608	120
PUPOC01	245	REIN4012	350	RENO4828	114	SCCI303030	220	SIPRT280	85	SJZ0810	120
PUPOC02	245	REIN4016	115	RENO4830	114	SCCI404040	220	SIUNIB280	85	SJZ0811	120
PUPOC03	245	REIN4016	350	RENO4835	114	SCCI606060	220	SIUNIG280	85	SJZ0811	120
PUPOL01	245	REIN4810	115	RENO6008	114	SCED050503	218	SIUNIT280	85	SJZ1013	120
PUPOL02	245	REIN4810	350	RENO6010	114	SCED060604	218	SIUNSB280	86	SJZ1014	120
PUPOL03	245	REIN4812	115	RENO6012	114	SCED070705	218	SIUNST280	86	SJZ1216	120
										SJZ1220	120

Ref	pág	Ref	pág	Ref	pág	Ref	pág	Ref	pág		
SJZ1422	120	SOTP4121	297	SUCL02	320	T0840516Z	233	T8148032	174	T8239038	175
SJZ1426	120	SOTP4141	295	SUCL04	320	T0840520Z	233	T8148038	174	T8239045	175
SJZ1630	120	SOTP4141	297	SUCL10	320	T0840525Z	233	T8148045	174	T8239050	175
SJZ1634	120	SOU004110	218	SUCL15	320	T0840530Z	233	T8148050	174	T8242013	175
SJZ1640	120	SOU006100	218	SUCU0602	321	T0840535Z	233	T8148060	174	T8242016	175
SJZ1845	120	SOU007125	218	SUCU0605	321	T0840540Z	233	T8148070	174	T8242019	175
SJZ2050	120	SOU008120	218	SUCU0606	321	T0840545Z	233	T8148080	174	T8242022	175
SLPC10070	55	SOU010140	218	SUCU0607	321	T0840550Z	233	T8148090	174	T8242025	175
SLPC10080	55	SOUR30140DR	218	SUMOM06	320	T0840560Z	233	T8148100	174	T8242032	175
SLPC10100	55	SOUR30140IZ	218	SUMOM08	320	T0840608Z	233	T8148110	174	T8242038	175
SLPC12100	55	SPGH2718	294	SUMOM10	320	T0840610Z	233	T8148120	174	T8242045	175
SLPC16100	55	SPGH3840	294	SUMOM12	320	T0840616Z	233	T8155013	174	T8242050	175
SLPC16120	55	SPH2718	293	SUMOP09	320	T0840620Z	233	T8155016	174	T8242060	175
SLPC18120	55	SPH3840	293	SUMOP11	320	T0840625Z	233	T8155019	174	T8242070	175
SLPE12095	55	SPRXH4121	296	SUMOP13	320	T0840630Z	233	T8155022	174	T8248013	175
SLPE12155	55	SPRXV4121	296	SUMOP13	320	T0840635Z	233	T8155025	174	T8248016	175
SLPE16125	55	SPUX412100	296	SUSTC47090	141	T0840640Z	233	T8155032	174	T8248019	175
SLPE16160	55	SPUX412145	296	SUSTC47180	141	T0840645Z	233	T8155038	174	T8248022	175
SLPE16245	55	SPV2718	293	SUSTC47240	141	T0840650Z	233	T8155045	174	T8248025	175
SLPE18150	55	SPV3840	293	SUSTC47300	141	T0840660Z	233	T8155050	174	T8248032	175
SLPE18170	55	SPX3840	293	SUSTC47400	141	T8129006	174	T8155060	174	T8248038	175
SLPE18260	55	SPX412115	296	SUVA0602	320	T8129009	174	T8155070	174	T8248045	175
SLPE24145	55	SPX412130	296	SUVA0604	320	T8129013	174	T8155080	174	T8248050	175
SLPE24170	55	SPX412145	296	SUVA0610	320	T8129016	174	T8155090	174	T8248060	175
SLPE24200	55	SPX414110	296	SUVA0615	320	T8129019	174	T8155100	174	T8248070	175
SLPE24280	55	SPX414115	296	SUVA0802	320	T8129022	174	T8155110	174	T8255013	175
SLPE28210	55	SPX414130	296	SUVA0804	320	T8129025	174	T8155120	174	T8255016	175
SLPE28230	55	SPX414145	296	SUVA0810	320	T8135006	174	T8163016	174	T8255019	175
SLPE28230	55	SPX414160	296	SUVA0815	320	T8135009	174	T8163019	174	T8255022	175
SLPE28310	55	SPX414175	296	SVCBL	213	T8135013	174	T8163022	174	T8255025	175
SLPT10070	55	SPZ271820	293	SVCMA	213	T8135016	174	T8163025	174	T8255032	175
SLPT10080	55	SPZ271830	293	SVNB01	213	T8135019	174	T8163032	174	T8255038	175
SLPT10100	55	SPZ384020	293	SVNB02	213	T8135025	174	T8163038	174	T8255045	175
SLPT10110	55	SPZ384025	293	SVNM01	213	T8135032	174	T8163045	174	T8255050	175
SLPT12080	55	SPZ384030	293	SVNM02	213	T8135032	174	T8163050	174	T8255060	175
SLPT12090	55	SPZ384035	293	T813509BLE	173	T8139009	174	T8163060	174	T8255070	175
SLPT12100	55	SPZ384040	293	T814213BLE	173	T8139013	174	T8163070	174	T8263025	175
SLPT12120	55	SPZ384050	293	T814225BLE	173	T8139016	174	T8163080	174	T8263032	175
SLPT16100	55	SPZ384060	293	T0840304Z	233	T8139019	174	T8163090	174	T8263038	175
SLPT16120	55	STR1680	312	T0840306Z	233	T8139022	174	T8163100	174	T8263045	175
SLPT16140	55	STR1680	370	T0840308Z	233	T8139025	174	T8163110	174	T8263050	175
SLPT16160	55	SUAB0603	321	T0840310Z	233	T8139032	174	T8163120	174	T8263060	175
SLPT18110	55	SUAB0607	321	T0840312Z	233	T8139038	174	T8229006	175	T8263070	175
SLPT18120	55	SUAB0614	321	T0840316Z	233	T8139045	174	T8229009	175	T9630410Z	235
SLPT18140	55	SUCA0602	321	T0840320Z	233	T8139050	174	T8229013	175	T9630412Z	235
SLPT18150	55	SUCA0604	321	T0840325Z	233	T8142009	174	T8229016	175	T9630416Z	235
SLPT18170	55	SUCA0607	321	T0840330Z	233	T8142013	174	T8229019	175	T9630420Z	235
SLPT18200	55	SUCA0802	321	T0840335Z	233	T8142016	174	T8229022	175	T9630430Z	235
SLPT24140	55	SUCA0804	321	T0840340Z	233	T8142019	174	T8229025	175	T9630440Z	235
SLPT24170	55	SUCA0807	321	T0840406Z	233	T8142022	174	T8235009	175	T9630450Z	235
SLPT24200	55	SUCA1002	321	T0840408Z	233	T8142025	174	T8235013	175	T9630510Z	235
SLPT24220	55	SUCA1004	321	T0840410Z	233	T8142032	174	T8235016	175	T9630512Z	235
SLPT28170	55	SUCA1007	321	T0840412Z	233	T8142038	174	T8235019	175	T9630516Z	235
SLPT28200	55	SUCA1202	321	T0840416Z	233	T8142045	174	T8235022	175	T9630520Z	235
SLPT28240	55	SUCA1204	321	T0840420Z	233	T8142050	174	T8235025	175	T9630525Z	235
SOPG27	300	SUCA1207	321	T0840425Z	233	T8142060	174	T8235032	175	T9630530Z	235
SOPG38	300	SUCA1502	321	T0840435Z	233	T8142070	174	T8235038	175	T9630540Z	235
SOPG41	300	SUCA1504	321	T0840445Z	233	T8142080	174	T8239009	175	T9630550Z	235
SOTP2718	295	SUCA1507	321	T0840450Z	233	T8142090	174	T8239013	175	T9630560Z	235
SOTP2718	297	SUCA1902	321	T0840460Z	233	T8148009	174	T8239016	175	T9630610Z	235
SOTP2830	295	SUCA1904	321	T0840470Z	233	T8148013	174	T8239019	175	T9630612Z	235
SOTP2830	297	SUCA1907	321	T0840506Z	233	T8148016	174	T8239022	175	T9630616Z	235
SOTP3840	295	SUCA2502	321	T0840508Z	233	T8148019	174	T8239025	175	T9630620Z	235
SOTP3840	297	SUCA2504	321	T0840510Z	233	T8148022	174	T8239032	175	T9630625Z	235
SOTP4121	295	SUCA2507	321	T0840512Z	233	T8148025	174				

Ref	pág	Ref	pág	Ref	pág	Ref	pág	Ref	pág		
T9630630Z	235	T9850516Z	234	T738010025	242	TB06030	198	TB12200	198	TCA206060	349
T9630640Z	235	T9850520Z	234	T738010030	242	TB06035	198	TB12220	198	TCA208060	96
T9630650Z	235	T9850525Z	234	T738010035	242	TB06040	198	TB12240	198	TCA208060	349
T9630660Z	235	T9850530Z	234	T738010040	242	TB06045	198	TB12260	198	TCA208080	96
T9650306Z	235	T9850535Z	234	T738010045	242	TB06050	198	TB14100	198	TCA208080	349
T9650308Z	235	T9850540Z	234	T738010050	242	TB06060	198	TBA206040	199	TCA208100	96
T9650310Z	235	T9850545Z	234	T738010060	242	TB06070	198	TBA206040	357	TCA208100	349
T9650312Z	235	T9850550Z	234	TACB166025	315	TB06080	198	TBA206050	199	TCCA05025	97
T9650316Z	235	T9850608Z	234	TACB166025	372	TB06090	198	TBA206050	357	TCCA05030	97
T9650320Z	235	T9850610Z	234	TACN165525	315	TB06100	198	TBA206060	199	TCCA05035	97
T9650325Z	235	T9850612Z	234	TACOB166025	281	TB06110	198	TBA206060	357	TCCA05050	97
T9650408Z	235	T9850616Z	234	TACOB166025	281	TB06120	198	TBA206070	199	TCCA06035	97
T9650410Z	235	T9850620Z	234	TACOB166025	281	TB07030	198	TBA206070	357	TCCA06040	97
T9650412Z	235	T9850625Z	234	TACOB166025	281	TB07040	198	TBA208050	199	TCCA06050	97
T9650416Z	235	T9850630Z	234	TACOB166025	281	TB07050	198	TBA208050	357	TCCA06060	97
T9650420Z	235	T9850635Z	234	TACOB166025	281	TB07060	198	TBA208060	199	TCCA06070	97
T9650425Z	235	T9850640Z	234	TACOB166025	281	TB07070	198	TBA208060	357	TCCA06080	97
T9650430Z	235	T9850650Z	234	TACOB166025	281	TB07080	198	TBA208070	199	TCCA08060	97
T9650435Z	235	T9850660Z	234	TACOB166025	281	TB07090	198	TBA208070	357	TCCA08080	97
T9650440Z	235	T738003012	242	TACOB166025	281	TB07100	198	TBA208080	199	TCCA08100	97
T9650450Z	235	T738003016	242	TACOB166025	281	TB07120	198	TBA208080	357	TCCA08120	97
T9650510Z	235	T738003020	242	TACOB166025	281	TB08030	198	TBA210080	199	TCCA08140	97
T9650512Z	235	T738004008	242	TACOB166025	281	TB08040	198	TBA210080	357	TCCAEP5030	97
T9650516Z	235	T738004010	242	TACOB166025	281	TB08045	198	TBR06050	199	TCCAEP6040	97
T9650520Z	235	T738004016	242	TACOB166025	281	TB08050	198	TBR06060	199	TCCC05025	96
T9650525Z	235	T738004020	242	TACOB166025	281	TB08060	198	TBR06070	199	TCCC05030	96
T9650530Z	235	T738004025	242	TACOB166025	281	TB08070	198	TBR08050	199	TCCC05035	96
T9650535Z	235	T738004030	242	TACOB166025	281	TB08080	198	TBR08060	199	TCCC05050	96
T9650540Z	235	T738004040	242	TACOB166025	281	TB08090	198	TBR08070	199	TCCC06035	96
T9650550Z	235	T738005010	242	TACOB166025	281	TB08100	198	TBR08080	199	TCCC06040	96
T9650560Z	235	T738005012	242	TACOB166025	281	TB08110	198	TBR10060	199	TCCC06050	96
T9650610Z	235	T738005014	242	TACOB166025	281	TB08120	198	TBR10080	199	TCCC06060	96
T9650612Z	235	T738005016	242	TACOB166025	281	TB08130	198	TC2A06060	95	TCCC06070	96
T9650616Z	235	T738005020	242	TACOB166025	281	TB08140	198	TC2A08060	95	TCCC06080	96
T9650620Z	235	T738005025	242	TACOB166025	281	TB08150	198	TC2A08080	95	TCCC08060	96
T9650625Z	235	T738005030	242	TACOB166025	281	TB08160	198	TC2A08100	95	TCCC08080	96
T9650630Z	235	T738005035	242	TACOB166025	281	TB08180	198	TC2A08120	95	TCCC08100	96
T9650635Z	235	T738005040	242	TACOB166025	281	TB08200	198	TC2A10065	95	TCCC08120	96
T9650640Z	235	T738005050	242	TACOB166025	281	TB10040	198	TC2A10080	95	TCCC08140	96
T9650650Z	235	T738006008	242	TACOB166025	281	TB10050	198	TC2A10100	95	TCMA05022	66
T9650660Z	235	T738006010	242	TACOB166025	281	TB10060	198	TC2A10115	95	TCMA06030	66
T9850306Z	234	T738006012	242	TACOB166025	281	TB10070	198	TC2A10135	95	TCMA06040	66
T9850308Z	234	T738006016	242	TACOB166025	281	TB10080	198	TC2A10160	95	TCMA06050	66
T9850310Z	234	T738006020	242	TACOB166025	281	TB10090	198	TC6A08080	95	TCPA24213	178
T9850312Z	234	T738006025	242	TACOB166025	281	TB10100	198	TC6A08100	95	TCPA24213	356
T9850316Z	234	T738006030	242	TACOB166025	281	TB10110	198	TC6A08120	95	TCPA24222	178
T9850320Z	234	T738006035	242	TACOB166025	281	TB10120	198	TC6A10100	95	TCPA24222	356
T9850325Z	234	T738006040	242	TACOB166025	281	TB10130	198	TC6A10120	95	TCPA24232	178
T9850330Z	234	T738006045	242	TACOB166025	281	TB10140	198	TC6A10140	95	TCPA24232	356
T9850406Z	234	T738006050	242	TACOB166025	281	TB10150	198	TC6A10160	95	TCPB4213	178
T9850408Z	234	T738006060	242	TACOB166025	281	TB10160	198	TC6A10200	95	TCPB4222	178
T9850410Z	234	T738008010	242	TACOB166025	281	TB10180	198	TC6E08080	95	TCPB4232	178
T9850412Z	234	T738008012	242	TACOB166025	281	TB10200	198	TC6E08100	95	TCPN4213	178
T9850416Z	234	T738008016	242	TACOB166025	281	TB12060	198	TC6E08120	95	TCPN4222	178
T9850420Z	234	T738008020	242	TACOB166025	281	TB12070	198	TC6E10100	95	TCPN4232	178
T9850425Z	234	T738008025	242	TACOB166025	281	TB12080	198	TC6E10120	95	TCPZ4213	178
T9850430Z	234	T738008030	242	TACOB166025	281	TB12090	198	TC6E10140	95	TCPZ4222	178
T9850435Z	234	T738008035	242	TACOB166025	281	TB12100	198	TC6E10160	95	TCPZ4232	178
T9850440Z	234	T738008040	242	TACOB166025	281	TB12120	198	TC6E10200	95	TCSOI4075	73
T9850450Z	234	T738008045	242	TACOB166025	281	TB12130	198	TCA205030	96	TCSOI4100	73
T9850506Z	234	T738008050	242	TACOB166025	281	TB12140	198	TCA205030	349	TCSOI4130	73
T9850508Z	234	T738008060	242	TACOB166025	281	TB12150	198	TCA206040	96	TCSOI4160	73
T9850510Z	234	T738010016	242	TACOB166025	281	TB12160	198	TCA206040	349	TCSOI6140	73
T9850512Z	234	T738010020	242	TACOB166025	281	TB12180	198	TCA206060	96	TCSOI6160	73

Ref	pág	Ref	pág	Ref	pág	Ref	pág	Ref	pág	Ref	pág
TCSO16200	73	TEXBP30015	184	TEXBP60100	184	TEXBT60090	186	TEXZP40035	185	TEXZT40050	187
TCSO16240	73	TEXBP30016	184	TEXBP60110	184	TEXBT60100	186	TEXZP40040	185	TEXZT40055	187
TCSP05027	96	TEXBP30020	184	TEXBP60120	184	TEXBT60110	186	TEXZP40045	185	TEXZT40060	187
TCSP06032	96	TEXBP30025	184	TEXBT10080	186	TEXBT60120	186	TEXZP40050	185	TEXZT40070	187
TCSP06040	96	TEXBP30030	184	TEXBT10100	186	TEXBT60130	186	TEXZP40055	185	TEXZT45030	187
TCSPEP05027	96	TEXBP30035	184	TEXBT10120	186	TEXBT60140	186	TEXZP40060	185	TEXZT45035	187
TCSPEP06032	96	TEXBP30040	184	TEXBT10140	186	TEXBT60150	186	TEXZP40070	185	TEXZT45040	187
TCSPEP06040	96	TEXBP30045	184	TEXBT10160	186	TEXBT60160	186	TEXZP40080	185	TEXZT45050	187
TDR2572025	162	TEXBP35010	184	TEXBT10180	186	TEXBT60180	186	TEXZP45016	185	TEXZT45060	187
TDR2572032	162	TEXBP35012	184	TEXBT10200	186	TEXBT60200	186	TEXZP45020	185	TEXZT45070	187
TDR2572038	162	TEXBP35015	184	TEXBT10220	186	TEXBT60220	186	TEXZP45025	185	TEXZT45080	187
TE25050	105	TEXBP35016	184	TEXBT10240	186	TEXBT60240	186	TEXZP45030	185	TEXZT50030	187
TE25090	105	TEXBP35020	184	TEXBT30016	186	TEXBT60260	186	TEXZP45035	185	TEXZT50035	187
TECBT10100	189	TEXBP35025	184	TEXBT30020	186	TEXBT60280	186	TEXZP45040	185	TEXZT50040	187
TECBT10120	189	TEXBP35030	184	TEXBT30025	186	TEXBT60300	186	TEXZP45045	185	TEXZT50045	187
TECBT10140	189	TEXBP35035	184	TEXBT30030	186	TEXBT80080	186	TEXZP45050	185	TEXZT50050	187
TECBT10160	189	TEXBP35040	184	TEXBT30035	186	TEXBT80100	186	TEXZP45060	185	TEXZT50060	187
TECBT10180	189	TEXBP35045	184	TEXBT30040	186	TEXBT80120	186	TEXZP45070	185	TEXZT50070	187
TECBT10200	189	TEXBP35050	184	TEXBT35012	186	TEXBT80140	186	TEXZP45080	185	TEXZT50080	187
TECBT10220	189	TEXBP40012	184	TEXBT35016	186	TEXBT80160	186	TEXZP50025	185	TEXZT50090	187
TECBT10240	189	TEXBP40015	184	TEXBT35020	186	TEXBT80180	186	TEXZP50030	185	TEXZT50100	187
TECBT10260	189	TEXBP40016	184	TEXBT35025	186	TEXBT80200	186	TEXZP50035	185	TEXZT60050	187
TECBT10280	189	TEXBP40020	184	TEXBT35030	186	TEXBT80220	186	TEXZP50040	185	TEXZT60060	187
TECBT10300	189	TEXBP40025	184	TEXBT35035	186	TEXBT80240	186	TEXZP50045	185	TEXZT60070	187
TECBT60080	189	TEXBP40030	184	TEXBT35040	186	TEXBT80260	186	TEXZP50050	185	TEXZT60080	187
TECBT60100	189	TEXBP40035	184	TEXBT35045	186	TEXBT80280	186	TEXZP50060	185	TEXZT60090	187
TECBT60120	189	TEXBP40040	184	TEXBT35050	186	TEXBT80300	186	TEXZP50070	185	TEXZT60100	187
TECBT60140	189	TEXBP40045	184	TEXBT40016	186	TEXBT80320	186	TEXZP50080	185	TEXZT60110	187
TECBT60160	189	TEXBP40050	184	TEXBT40020	186	TEXBT80340	186	TEXZP50090	185	TEXZT60120	187
TECBT60180	189	TEXBP40055	184	TEXBT40025	186	TEXBT80360	186	TEXZP50100	185	TEXZT60130	187
TECBT60200	189	TEXBP40060	184	TEXBT40030	186	TEXBT80380	186	TEXZP50110	185	TEXZT60140	187
TECBT80080	189	TEXBP40070	184	TEXBT40035	186	TEXBT80400	186	TEXZP50120	185	TEXZT60150	187
TECBT80100	189	TEXBP40080	184	TEXBT40040	186	TEXZP25010	185	TEXZP60040	185	TEXZT60160	187
TECBT80120	189	TEXBP45016	184	TEXBT40045	186	TEXZP25012	185	TEXZP60045	185	TEXZT60180	187
TECBT80140	189	TEXBP45020	184	TEXBT40050	186	TEXZP25016	185	TEXZP60050	185	TEXZT60200	187
TECBT80160	189	TEXBP45025	184	TEXBT40055	186	TEXZP25020	185	TEXZP60060	185	TEXZT60220	187
TECBT80180	189	TEXBP45030	184	TEXBT40060	186	TEXZP25025	185	TEXZP60070	185	TEXZT60240	187
TECBT80200	189	TEXBP45035	184	TEXBT40070	186	TEXZP30010	185	TEXZP60080	185	TEXZT60260	187
TECBT80220	189	TEXBP45040	184	TEXBT45025	186	TEXZP30012	185	TEXZP60090	185	TEXZT60280	187
TECBT80240	189	TEXBP45045	184	TEXBT45030	186	TEXZP30015	185	TEXZP60100	185	TEXZT60300	187
TECBT80260	189	TEXBP45050	184	TEXBT45035	186	TEXZP30016	185	TEXZP60110	185	TFA05040	51
TECBT80280	189	TEXBP45060	184	TEXBT45040	186	TEXZP30020	185	TEXZP60120	185	TFA05060	51
TECBT80300	189	TEXBP45070	184	TEXBT45045	186	TEXZP30025	185	TEXZT30016	187	TFA05080	51
TEGA25	276	TEXBP45080	184	TEXBT45050	186	TEXZP30030	185	TEXZT30020	187	TFA05100	51
TEGA33	276	TEXBP50025	184	TEXBT45060	186	TEXZP30035	185	TEXZT30025	187	TFA06045	51
TEGR2530	276	TEXBP50030	184	TEXBT45070	186	TEXZP30040	185	TEXZT30030	187	TFA06050	51
TEMO25	276	TEXBP50035	184	TEXBT45080	186	TEXZP30045	185	TEXZT30035	187	TFA06060	51
TEMO33	276	TEXBP50040	184	TEXBT50030	186	TEXZP35010	185	TEXZT30040	187	TFA06080	51
TEPE2530	276	TEXBP50045	184	TEXBT50035	186	TEXZP35012	185	TEXZT35012	187	TFA06100	51
TEXA250050	187	TEXBP50050	184	TEXBT50040	186	TEXZP35015	185	TEXZT35016	187	TFA06120	51
TEXA250050	356	TEXBP50060	184	TEXBT50045	186	TEXZP35016	185	TEXZT35020	187	TFA06140	51
TEXA250060	187	TEXBP50070	184	TEXBT50050	186	TEXZP35020	185	TEXZT35025	187	TFA08060	51
TEXA250060	356	TEXBP50080	184	TEXBT50060	186	TEXZP35025	185	TEXZT35030	187	TFA08080	51
TEXA250070	187	TEXBP50090	184	TEXBT50070	186	TEXZP35030	185	TEXZT35035	187	TFA08100	51
TEXA250070	356	TEXBP50100	184	TEXBT50080	186	TEXZP35035	185	TEXZT35040	187	TFA08120	51
TEXABM06	189	TEXBP50110	184	TEXBT50090	186	TEXZP35040	185	TEXZT35045	187	TFA10100	51
TEXABM08	189	TEXBP50120	184	TEXBT50100	186	TEXZP35045	185	TEXZT35050	187	TFA10120	51
TEXABM10	189	TEXBP60040	184	TEXBT50120	186	TEXZP35050	185	TEXZT40016	187	TFE05040	50
TEXBP25010	184	TEXBP60045	184	TEXBT60040	186	TEXZP40012	185	TEXZT40020	187	TFE05050	50
TEXBP25012	184	TEXBP60050	184	TEXBT60045	186	TEXZP40015	185	TEXZT40025	187	TFE05060	50
TEXBP25016	184	TEXBP60060	184	TEXBT60050	186	TEXZP40016	185	TEXZT40030	187	TFE05080	50
TEXBP25020	184	TEXBP60070	184	TEXBT60060	186	TEXZP40020	185	TEXZT40035	187	TFE05100	50
TEXBP25025	184	TEXBP60080	184	TEXBT60070	186	TEXZP40025	185	TEXZT40040	187	TFE06035	50
TEXBP30012	184	TEXBP60090	184	TEXBT60080	186	TEXZP40030	185	TEXZT40045	187	TFE06040	50

Ref	pág	Ref	pág	Ref	pág	Ref	pág	Ref	pág	Ref	pág
TFE06045	50	TFP06040	51	THE06040	48	TN4S06EP	98	TNXA410140	93	TPMTNE06	45
TFE06050	50	TFP06050	51	THE06045	48	TN4S06L	100	TNXA410140	349	TPMTNE08	45
TFE06060	50	TFP06060	51	THE06050	48	TN4S08	98	TNXE408080	94	TPMTNE10	45
TFE06070	50	TFP06080	51	THE06060	48	TN4S08EP	98	TNXE408080	349	TPMTNE12	45
TFE06080	50	TFP06100	51	THE06070	48	TN4S08L	100	TNXE408100	94	TPMTNE16	45
TFE06100	50	TFP08060	51	THE06080	48	TN4S10	98	TNXE408100	349	TPPO25010	192
TFE06120	50	TFP08080	51	THE06100	48	TN4S10EP	98	TNXE410080	94	TPPO25012	192
TFE08055	50	TF0506100	52	THE06120	48	TN4S10L	100	TNXE410080	349	TPPO25016	192
TFE08060	50	TF0506120	52	THE08055	48	TN4S12	98	TNXE410100	94	TPPO25020	192
TFE08070	50	TF0508110	52	THE08060	48	TN4S14	98	TNXE410100	349	TPPO25025	192
TFE08075	50	TF0508130	52	THE08070	48	TN4SA06	100	TNXE410120	94	TPPO30012	192
TFE08080	50	TF0510120	52	THE08075	48	TN4SA06EP	100	TNXE410120	349	TPPO30016	192
TFE08090	50	TF0510140	52	THE08080	48	TNUX08060	94	TNXE410140	94	TPPO30020	192
TFE08100	50	TFT06040	51	THE08090	48	TNUX08080	94	TNXE410140	349	TPPO30025	192
TFE08110	50	TFT06050	51	THE08100	48	TNUX08100	94	TPA230016	197	TPPO30030	192
TFE08120	50	TFT06060	51	THE08110	48	TNUX08120	94	TPA230016	357	TPPO30040	192
TFE08140	50	TFUXE10080	94	THE08120	48	TNUX10060	94	TPA230025	197	TPPO35016	192
TFE10060	50	TFUXE10100	94	THE08140	48	TNUX10080	94	TPA230025	357	TPPO35020	192
TFE10070	50	TFUXE10120	94	THE10060	48	TNUX10100	94	TPA235020	197	TPPO35025	192
TFE10080	50	TFUXE10140	94	THE10070	48	TNUX10120	94	TPA235020	357	TPPO35030	192
TFE10090	50	TFY08055	51	THE10080	48	TNUX10140	94	TPA235025	197	TPPO35035	192
TFE10100	50	TFY08075	51	THE10090	48	TNUXA08060	93	TPA235025	357	TPPO35040	192
TFE10120	50	TFY12075	51	THE10100	48	TNUXA08080	93	TPA235030	197	TPPO35050	192
TFE10140	50	TC230620	294	THE10120	48	TNUXA08100	93	TPA235030	357	TPPO40016	192
TFE10160	50	TC230820	294	THE10140	48	TNUXA08120	93	TPA235040	197	TPPO40020	192
TFE10180	50	TC230830	294	THE10160	48	TNUXA10060	93	TPA235040	357	TPPO40025	192
TFE12080	50	TC340830	294	THE10180	48	TNUXA10080	93	TPA240030	197	TPPO40030	192
TFE12090	50	TC341030	294	THE12080	48	TNUXA10100	93	TPA240030	357	TPPO40035	192
TFE12100	50	TGR230620	294	THE12090	48	TNUXA10120	93	TPA240040	197	TPPO40040	192
TFE12110	50	TGR230820	294	THE12100	48	TNUXA10140	93	TPA240040	357	TPPO40045	192
TFE12130	50	TGR230830	294	THE12110	48	TNUXA10160	93	TPA240050	197	TPPO40050	192
TFE12150	50	TGR340830	294	THE12130	48	TNUXA10180	93	TPA240050	357	TPPO40060	192
TFE14080	50	TGR341030	294	THE12150	48	TNUXA10200	93	TPA245030	197	TPPO40070	192
TFE14100	50	TGRX0830	297	THE14080	48	TNUXA10230	93	TPA245030	357	TPPO45020	192
TFE14110	50	TGRX0860	297	THE14100	48	TNUXE08060	93	TPA245050	197	TPPO45025	192
TFE14120	50	TGRX1030	297	THE14110	48	TNUXE08080	93	TPA245050	357	TPPO45030	192
TFE14130	50	TGRX1060	297	THE14120	48	TNUXE08100	93	TPA250050	197	TPPO45035	192
TFE14140	50	TCX0840	297	THE14130	48	TNUXE08120	93	TPA250050	357	TPPO45040	192
TFE14160	50	TCX0860	297	THE14140	48	TNUXE10060	93	TPA250070	197	TPPO45045	192
TFE16100	50	TCX1040	297	THE14160	48	TNUXE10080	93	TPA250070	357	TPPO45050	192
TFE16150	50	TCX1060	297	THE16100	48	TNUXE10100	93	TPAA151230	310	TPPO45060	192
TFE18100	50	THA05040	49	THE16150	48	TNUXE10120	93	TPAA151750	310	TPPO45070	192
TFE18130	50	THA05060	49	THE18100	48	TNUXE10140	93	TPAA301230	310	TPPO45080	192
TFE18160	50	THA05080	49	THE18130	48	TNUXE10160	93	TPAA301750	310	TPPO50020	192
TFE18180	50	THA05100	49	THE18160	48	TNUXE10180	93	TPAC151230	310	TPPO50025	192
TFE18200	50	THA06045	49	THE18180	48	TNUXE10200	93	TPAC151750	310	TPPO50030	192
TF050355	52	THA06050	49	THE18200	48	TNUXE10230	93	TPAC301230	310	TPPO50035	192
TF06035	52	THA06060	49	THP05040	49	TNUXT10080	94	TPAC301750	310	TPPO50040	192
TF06040	52	THA06080	49	THP05060	49	TNUXT10100	94	TPAP352000	310	TPPO50045	192
TF06055	52	THA06100	49	THP06040	49	TNUXT10120	94	TPAR251500	310	TPPO50050	192
TF08050T	52	THA06120	49	THP06050	49	TNUXT10140	94	TPBLANC	53	TPPO50060	192
TF08050W	52	THA06140	49	THP06060	49	TNUXT10160	94	TPCR042BL	247	TPPO50070	192
TF14825	203	THA08060	49	THP06080	49	TNXA408080	93	TPCR042NE	247	TPPO50080	192
TF14835	203	THA08080	49	THP06100	49	TNXA408080	349	TPCR048BL	247	TPPO50090	192
TF14845	203	THA08100	49	THP08060	49	TNXA408100	93	TPCR048NE	247	TPPO50100	192
TF14855	203	THA08120	49	THP08080	49	TNXA408100	349	TPCR055BL	247	TPPO50120	192
TF14865	203	THA10100	49	THT06040	49	TNXA408120	93	TPCR055NE	247	TPPO60040	192
TF14875	203	THA10120	49	THT06050	49	TNXA408120	349	TPGPXS	307	TPPO60050	192
TF14890	203	THE05040	48	THT06060	49	TNXA410080	93	TPMARRO	53	TPPO60060	192
TFM06035	53	THE05050	48	TMVR06065	328	TNXA410080	349	TPMTBL06	45	TPPO60070	192
TFM06055	53	THE05060	48	TMVR07065	328	TNXA410100	93	TPMTBL08	45	TPPO60080	192
TFN14080	52	THE05080	48	TMVR08065	328	TNXA410100	349	TPMTBL10	45	TPPO60090	192
TFPO5040	51	THE05100	48	TN4S05	98	TNXA410120	93	TPMTBL12	45	TPPO60100	192
TFPO5060	51	THE06035	48	TN4S06	98	TNXA410120	349	TPMTBL16	45	TPPO60110	192

Ref	pág	Ref	pág	Ref	pág	Ref	pág	Ref	pág		
TPPO60120	192	TPPOZ60070	194	TPTPADCA	247	TRPO35035	197	TSGG08	123	TXA08120	47
TPPO60130	192	TPPOZ60080	194	TPTPADCE	247	TRPO40016	197	TSGG10	123	TXA08120	345
TPPO60140	192	TPPOZ60090	194	TPTPADGR	247	TRPO40020	197	TSGG12	123	TXA10070	47
TPPO60150	192	TPPOZ60100	194	TPTPADHA	247	TRPO40025	197	TSGG14	123	TXA10070	345
TPPO60160	192	TPPOZ60110	194	TPTPADNE	247	TRPO40030	197	TSGG16	123	TXA10090	47
TPPO60180	192	TPPOZTS05	100	TPTPADNO	247	TRPO40035	197	TSGG20	123	TXA10090	345
TPPO60200	192	TPPOZTS06	100	TPTPADPI	247	TRPO40040	197	TSGG22	123	TXA10120	47
TPPO60220	192	TPPOZTS08	100	TPTPADRO	247	TRPO40050	197	TSGG24	123	TXA10120	345
TPPOTS06EP	100	TPPOZTS10	100	TPTPADSA	247	TRPO45016	197	TSGG30	123	TXE06040	47
TPPOTS08EP	100	TPPSAA	307	TRIS200200	141	TRPO45020	197	TSGG36	123	TXE06040	345
TPPOZ25010	194	TPPSEA	307	TRIS300300	141	TRPO45025	197	TSGGA405	123	TXE06060	47
TPPOZ25012	194	TPPSEC	307	TRIS400400	141	TRPO45030	197	TSGGA405	351	TXE06060	345
TPPOZ25016	194	TPTO30025	196	TRIS500500	141	TRPO45035	197	TSGGA406	123	TXE08070	47
TPPOZ25020	194	TPTO30030	196	TRIS600600	141	TRPO45040	197	TSGGA406	351	TXE08070	345
TPPOZ25025	194	TPTO35015	196	TRIS200200	141	TRPO45045	197	TSGGA408	123	TXE08080	47
TPPOZ30012	194	TPTO35017	196	TRIS300300	141	TRPO50020	197	TSGGA408	351	TXE08080	345
TPPOZ30016	194	TPTO35020	196	TRIS400400	141	TRPO50030	197	TSGGA410	123	TXE08090	47
TPPOZ30020	194	TPTO35025	196	TRIS500500	141	TRPO50040	197	TSGGA410	351	TXE08090	345
TPPOZ30025	194	TPTO35030	196	TRIS600600	141	TRPO50050	197	TSGGA412	123	TXE08105	47
TPPOZ30030	194	TPTO35040	196	TRA6050	71	TRPXS412515	310	TSGGA412	351	TXE08105	345
TPPOZ30040	194	TPTO35050	196	TRA6060	71	TSAA05	122	TSVS06	123	TXE10070	47
TPPOZ35016	194	TPTO40020	196	TRA6080	71	TSAA06	122	TSVS08	123	TXE10070	345
TPPOZ35020	194	TPTO40025	196	TRA8070	71	TSAA08	122	TSVS10	123	TXE10090	47
TPPOZ35025	194	TPTO40030	196	TRA8090	71	TSAA10	122	TSVS12	123	TXE10090	345
TPPOZ35030	194	TPTO40035	196	TRA8110	71	TSAA12	122	TSVS14	123	TXE10100	47
TPPOZ35035	194	TPTO40040	196	TRA8130	71	TSAA14	122	TSVS16	123	TXE10100	345
TPPOZ35040	194	TPTO40045	196	TRA8150	71	TSAA16	122	TSVS20	123	TXE10120	47
TPPOZ35050	194	TPTO40050	196	TRAV0411	117	TSAA20	122	TSVS22	123	TXE10120	345
TPPOZ40016	194	TPTO40060	196	TRAV0513	117	TSAA22	122	TSVS24	123	TXE12080	47
TPPOZ40020	194	TPTO40070	196	TRAV0616	117	TSAA24	122	TSVS30	123	TXE12080	345
TPPOZ40025	194	TPTO45030	196	TRAV0819	117	TSAA30	122	TSVS36	123	TXE12110	47
TPPOZ40030	194	TPTO45035	196	TRAV1021	117	TSAA36	122	TUG201006	294	TXE12110	345
TPPOZ40035	194	TPTO45040	196	TRBL200200	141	TSAAA405	122	TUG201008	294	TXP06050	47
TPPOZ40040	194	TPTO45045	196	TRBL300300	141	TSAAA405	351	TUG271808	294	TXP06050	346
TPPOZ40045	194	TPTO45050	196	TRBL400400	141	TSAAA406	122	TUG271810	294	TXP06060	47
TPPOZ40050	194	TPTO45060	196	TRBL500500	141	TSAAA406	351	TUGRA2706	294	TXP06060	346
TPPOZ40060	194	TPTO45070	196	TRBL600600	141	TSAAA408	122	TUGRA2708	294	TXP06080	47
TPPOZ40070	194	TPTO50030	196	TRCA0310	117	TSAAA408	351	TUGRA3808	294	TXP06080	346
TPPOZ45020	194	TPTO50035	196	TRCA0410	117	TSAAA410	122	TUGRA3810	294	TXP06100	47
TPPOZ45025	194	TPTO50040	196	TRCA0411	117	TSAAA410	351	TUGX08	298	TXP06100	346
TPPOZ45030	194	TPTO50045	196	TRCA0512	117	TSAAA412	122	TUGX10	298	TXP08060	47
TPPOZ45035	194	TPTO50050	196	TRCA0515	117	TSAAA412	351	TUGXMU08	298	TXP08060	346
TPPOZ45040	194	TPTO50060	196	TRCA0614	117	TSGA05	122	TUGXMU10	298	TXP08080	47
TPPOZ45045	194	TPTO50070	196	TRCA0616	117	TSGA06	122	TUMAM03	241	TXP08080	346
TPPOZ45050	194	TPTO50080	196	TRCA0816	117	TSGA08	122	TUMAM04	241	TXT06040	47
TPPOZ45060	194	TPTO50090	196	TRCA0818	117	TSGA10	122	TUMAM05	241	TXT06040	346
TPPOZ45070	194	TPTO50100	196	TRCA1017	117	TSGA12	122	TUMAM06	241	TXT06050	47
TPPOZ45080	194	TPTO50120	196	TRCA1022	117	TSGA14	122	TUMAM08	241	TXT06050	346
TPPOZ50020	194	TPTO60060	196	TRCA1223	117	TSGA16	122	TUMAM10	241	TXT06060	47
TPPOZ50025	194	TPTO60070	196	TRCR0410	117	TSGA20	122	TUMAM12	241	TXT06060	346
TPPOZ50030	194	TPTO60080	196	TRCR0511	117	TSGA22	122	TUMAM14	241	TZN812909	173
TPPOZ50035	194	TPTO60090	196	TRCR0614	117	TSGA24	122	TUMAM16	241	TZN813513	173
TPPOZ50040	194	TPTO60100	196	TRCR0815	117	TSGA30	122	TURX08	298	TZN813516	173
TPPOZ50045	194	TPTO60110	196	TRCR1019	117	TSGA36	122	TURX10	298	TZN813519	173
TPPOZ50050	194	TPTO60120	196	TREP05050	201	TSGAA405	122	TURX12	298	TZN813525	173
TPPOZ50060	194	TPTO60130	196	TREP07050	201	TSGAA405	351	TURXA08	298	TZN814216	173
TPPOZ50070	194	TPTO60140	196	TREZ05050	201	TSGAA406	122	TURXA10	298	TZN814219	173
TPPOZ50080	194	TPTO60150	196	TREZ07050	201	TSGAA406	351	TURXA208	308	TZN814225	173
TPPOZ50090	194	TPTO60160	196	TRPO30016	197	TSGAA410	122	TURXA208	369	TZN814232	173
TPPOZ50100	194	TPTO60180	196	TRPO30020	197	TSGAA410	351	TWA06060	45	TZN814238	173
TPPOZ50120	194	TPTO60200	196	TRPO35016	197	TSGAA412	122	TXA08060	47	TZN814816	173
TPPOZ60040	194	TPTO60220	196	TRPO35020	197	TSGAA412	351	TXA08060	345	TZN814819	173
TPPOZ60050	194	TPTPADBE	247	TRPO35025	197	TSGG05	123	TXA08080	47	TZN814822	173
TPPOZ60060	194	TPTPADBL	247	TRPO35030	197	TSGG06	123	TXA08080	345	TZN814825	173

Ref	pág	Ref	pág	Ref	pág	Ref	pág	Ref	pág		
TZN814838	173	VABP4832	169	VALRO19070	207	VD933106025	358	VD93403	236	VD93110070	229
TZN814850	173	VABP4838	169	VALRO20060	207	VD933106030	228	VD93404	236	VD93110080	229
UNCO3220	300	VABP5532	169	VALRO20070	207	VD933106030	358	VD93405	236	VD93112050	229
UNEX412103	299	VABR3509	166	VALRO20080	207	VD933106040	228	VD93406	236	VD93112060	229
UNPX412101	299	VABR3511	166	VALRO21080	207	VD933106040	358	VD93408	236	VD93112070	229
UNPX412102	299	VABR3513	166	VALRO21090	207	VD933106050	228	VD93410	236	VD93112080	229
UNPX412103	299	VABR3516	166	VALRO22100	207	VD933106050	358	VD93412	236	VD93304008	227
UNPX412104	299	VABR3519	166	VALRO22110	207	VD933108016	228	VD158704	238	VD93304010	227
UNTX412104	300	VABR3525	166	VALRO22120	207	VD933108016	358	VD158705	238	VD93304012	227
VABE3509	154	VABR3913	166	VALRO23130	207	VD933108020	228	VD158706	238	VD93304016	227
VABE3513	154	VABR3916	166	VAM06060	43	VD933108020	358	VD158708	238	VD93304020	227
VABE4213	154	VABR3919	166	VAM08075	43	VD933108025	228	VD158710	238	VD93304025	227
VABE4216	154	VABR3925	166	VAM08090	43	VD933108025	358	VD158712	238	VD93304030	227
VABE4219	154	VABR3932	166	VAM10070	43	VD933108030	228	VD902103	240	VD93304040	227
VABE4225	154	VABR4213	166	VAM10090	43	VD933108030	358	VD902104	240	VD93304050	227
VABE4232	154	VABR4216	166	VAM10120	43	VD933108040	228	VD902105	240	VD93304060	227
VABE4813	154	VABR4219	166	VAM12090	43	VD933108040	358	VD902106	240	VD93305010	227
VABE4816	154	VABR4222	166	VAM12110	43	VD933108050	228	VD902108	240	VD93305012	227
VABE4819	154	VABR4225	166	VARANE14	162	VD933108050	358	VD902110	240	VD93305016	227
VABE4825	154	VABR4232	166	VARANE16	162	VD933108060	228	VD902112	240	VD93305020	227
VABE4832	154	VABR4238	166	VARANE18	162	VD933108060	358	VD91204010	231	VD93305025	227
VABE4838	154	VABR4250	166	VARANE25	162	VD933110020	228	VD91204012	231	VD93305030	227
VABE5519	154	VABR4813	166	VCAPA004	109	VD933110020	358	VD91204020	231	VD93305040	227
VABE5522	154	VABR4816	166	VCAPA005	109	VD933110030	228	VD91204030	231	VD93305050	227
VABE5525	154	VABR4819	166	VCAPA006	109	VD933110030	358	VD91204040	231	VD93305060	227
VABE5532	154	VABR4822	166	VD125IM04	239	VD933110040	228	VD91204050	231	VD93305070	227
VABE5538	154	VABR4825	166	VD125IM04	360	VD933110040	358	VD91205010	231	VD93306016	227
VABE5550	154	VABR4832	166	VD125IM05	239	VD933110050	228	VD91205012	231	VD93306020	227
VABE5563	154	VABR4838	166	VD125IM05	360	VD933110050	358	VD91205016	231	VD93306025	227
VABE6319	154	VABR4845	166	VD125IM06	239	VD933110060	228	VD91205020	231	VD93306030	227
VABE6325	154	VABR4850	166	VD125IM06	360	VD933110060	358	VD91205025	231	VD93306040	227
VABE6332	154	VABR4860	166	VD125IM08	239	VD9341M04	236	VD91205030	231	VD93306050	227
VABE6338	154	VABR4880	166	VD125IM08	360	VD9341M04	359	VD91205040	231	VD93306060	227
VABE6350	154	VABR5532	166	VD125IM10	239	VD9341M05	236	VD91205050	231	VD93306070	227
VABE6363	154	VACHA08C	61	VD125IM10	360	VD9341M05	359	VD91206010	231	VD93308016	227
VABE144819	155	VACHA10C	61	VD933104010	228	VD9341M06	236	VD91206012	231	VD93308020	227
VABE144825	155	VACHG08C	60	VD933104010	358	VD9341M06	359	VD91206016	231	VD93308025	227
VABE164819	155	VACHG10C	60	VD933104016	228	VD9341M08	236	VD91206020	231	VD93308030	227
VABE165522	155	VACHT08C	57	VD933104016	358	VD9341M08	359	VD91206025	231	VD93308040	227
VABE165525	155	VACHT08L	57	VD933104020	228	VD9341M10	236	VD91206030	231	VD93308050	227
VABE165532	155	VACHT10C	57	VD933104020	358	VD9341M10	359	VD91206040	231	VD93308060	227
VABE165538	155	VACHT10L	57	VD933104030	228	VD90211M04	240	VD91206050	231	VD93308070	227
VABE165550	155	VACHT12C	57	VD933104030	358	VD90211M04	361	VD91206060	231	VD93308080	227
VABE166325	155	VACHT12L	57	VD933104040	228	VD90211M05	240	VD91208010	231	VD93308100	227
VABE166332	155	VACHT16C	57	VD933104040	358	VD90211M05	361	VD91208016	231	VD93310020	227
VABE166338	155	VACHTA208C	57	VD933105010	228	VD90211M06	240	VD91208020	231	VD93310030	227
VABP3513	169	VACHTA208C	346	VD933105010	358	VD90211M06	361	VD91208030	231	VD93310040	227
VABP3516	169	VACHTA208L	57	VD933105016	228	VD90211M08	240	VD91208040	231	VD93310050	227
VABP3519	169	VACHTA208L	346	VD933105016	358	VD90211M08	361	VD91208050	231	VD93310060	227
VABP3525	169	VACHTA210C	57	VD933105020	228	VD90211M10	240	VD91208060	231	VD93310070	227
VABP3913	169	VACHTA210C	346	VD933105020	358	VD90211M10	361	VD93106030	229	VD93310080	227
VABP3916	169	VACHTA210L	57	VD933105030	228	VD12503	239	VD93106040	229	VD93312030	227
VABP3919	169	VACHTA210L	346	VD933105030	358	VD12504	239	VD93106050	229	VD93312040	227
VABP3925	169	VACHTA212C	57	VD933105040	228	VD12505	239	VD93106060	229	VD93312050	227
VABP3938	169	VACHTA212C	346	VD933105040	358	VD12506	239	VD93106070	229	VD93312060	227
VABP4213	169	VACHTA212L	57	VD933105050	228	VD12508	239	VD93108030	229	VD93312070	227
VABP4216	169	VACHTA212L	346	VD933105050	358	VD12510	239	VD93108040	229	VD93312080	227
VABP4219	169	VALRO14025	207	VD933106010	228	VD12512	239	VD93108050	229	VD603905020	232
VABP4225	169	VALRO16030	207	VD933106010	358	VD12704	241	VD93108060	229	VD603905030	232
VABP4232	169	VALRO17040	207	VD933106016	228	VD12705	241	VD93108070	229	VD603905040	232
VABP4238	169	VALRO18040	207	VD933106016	358	VD12706	241	VD93108080	229	VD603905050	232
VABP4816	169	VALRO18050	207	VD933106020	228	VD12708	241	VD93110040	229	VD603906016	232
VABP4819	169	VALRO19050	207	VD933106020	358	VD12710	241	VD93110050	229	VD603906020	232
VABP4825	169	VALRO19060	207	VD933106025	228	VD12712	241	VD93110060	229	VD603906030	232

Ref	pág	Ref	pág	Ref	pág	Ref	pág	Ref	pág	Ref	pág
VD603906040	232	VMIA410090	345	VT8139019	174	VT9850306Z	234	VTEXA250060	187	VTEXZP45045	185
VD603906050	232	VMIA412110	42	VT8139022	174	VT9850310Z	234	VTEXA250060	356	VTEXZP45050	185
VD603906060	232	VMIA412110	345	VT8139025	174	VT9850316Z	234	VTEXA250070	187	VTEXZP45060	185
VD603906070	232	VMPF050	224	VT8142009	174	VT9850320Z	234	VTEXA250070	356	VTEXZP45070	185
VD603906080	232	VPACC15015	211	VT8142013	174	VT9850330Z	234	VTEXBP30016	184	VTEXZP50030	185
VD603908025	232	VPACC15020	211	VT8142016	174	VT9850406Z	234	VTEXBP30020	184	VTEXZP50035	185
VD603908030	232	VPACC15025	211	VT8142019	174	VT9850408Z	234	VTEXBP30025	184	VTEXZP50040	185
VD603908040	232	VPACC20025	211	VT8142022	174	VT9850410Z	234	VTEXBP30030	184	VTEXZP50045	185
VD603908050	232	VPACC20030	211	VT8142025	174	VT9850416Z	234	VTEXBP30040	184	VTEXZP50050	185
VD603908060	232	VPACC20035	211	VT8142032	174	VT9850420Z	234	VTEXBP35016	184	VTEXZP50060	185
VD603908070	232	VPACC20040	211	VT8142038	174	VT9850506Z	234	VTEXBP35020	184	VTEXZP50070	185
VD603908080	232	VPACC20045	211	VT8142050	174	VT9850510Z	234	VTEXBP35025	184	VTEXZP50080	185
VD603908090	232	VPACC20050	211	VT8148009	174	VT9850512Z	234	VTEXBP35030	184	VTEXZP60050	185
VD603908100	232	VPL35025	136	VT8148013	174	VT9850516Z	234	VTEXBP35035	184	VTEXZP60060	185
VD603910025	232	VPL35035	136	VT8148016	174	VT9850520Z	234	VTEXBP35040	184	VTEXZP60070	185
VD603910030	232	VPL35045	136	VT8148019	174	VT9850530Z	234	VTEXBP35050	184	VTEXZP60080	185
VD603910040	232	VRECA4010	115	VT8148025	174	VT9850540Z	234	VTEXBP40025	184	VTNUXA08080	93
VD603910050	232	VRECA4012	115	VT8148032	174	VT9850550Z	234	VTEXBP40030	184	VTNUXA08100	93
VD603910060	232	VRECA4016	115	VT8148038	174	VT9850610Z	234	VTEXBP40035	184	VTNUXA10080	93
VD603910070	232	VRECA4810	115	VT8148045	174	VT9850612Z	234	VTEXBP40040	184	VTNUXA10100	93
VD603910080	232	VRECA4812	115	VT8148050	174	VT9850616Z	234	VTEXBP40045	184	VTNUXE08080	93
VDZ98503	237	VRECA4814	115	VT8148060	174	VT9850620Z	234	VTEXBP40050	184	VTNUXE08100	93
VDZ98504	237	VRECA4816	115	VT8148070	174	VT9850630Z	234	VTEXBP40060	184	VTNUXE10080	93
VDZ98505	237	VRECA4818	115	VT8148080	174	VT9850640Z	234	VTEXBP45030	184	VTNUXE10100	93
VDZ98506	237	VREFL4835	116	VT8155019	174	VT9850650Z	234	VTEXBP45035	184	VTPOZ30025	195
VDZ98508	237	VRENO3206	114	VT8155025	174	VT9850660Z	234	VTEXBP45040	184	VTPOZ30030	195
VDZ98510	237	VRENO3208	114	VT8155032	174	VTALAM06	66	VTEXBP45045	184	VTPOZ35016	195
VDZ98512	237	VRENO3210	114	VT8155038	174	VTALAM08	66	VTEXBP45050	184	VTPOZ35020	195
VGMZ10016	212	VRENO3212	114	VT8235009	175	VTALAM10	66	VTEXBP45060	184	VTPOZ35025	195
VGMZ15026	212	VRENO3214	114	VT8235013	175	VTB05040	198	VTEXBP45070	184	VTPOZ35030	195
VGMZ19035	212	VRENO3218	114	VT8235016	175	VTB05050	198	VTEXBP50030	184	VTPOZ35035	195
VINCO432	110	VRENO4006	114	VT8235019	175	VTB06040	198	VTEXBP50035	184	VTPOZ35040	195
VINCO438	110	VRENO4008	114	VT8235025	175	VTB06050	198	VTEXBP50040	184	VTPOZ35050	195
VINCO446	110	VRENO4010	114	VT8239016	175	VTB06060	198	VTEXBP50050	184	VTPOZ40016	195
VINCO537	110	VRENO4012	114	VT8239019	175	VTB07050	198	VTEXBP50060	184	VTPOZ40020	195
VINCO552	110	VRENO4014	114	VT8239022	175	VTB07060	198	VTEXBP50070	184	VTPOZ40025	195
VINCO637	110	VRENO4016	114	VT8239025	175	VTB07070	198	VTEXBP50080	184	VTPOZ40030	195
VINCO652	110	VRENO4018	114	VT8242016	175	VTB07080	198	VTEXBP50090	184	VTPOZ40035	195
VINVN7060	200	VRENO4020	114	VT8242019	175	VTB08050	198	VTEXBP60050	184	VTPOZ40040	195
VINVN7070	200	VRENO4808	114	VT8242025	175	VTB08060	198	VTEXBP60060	184	VTPOZ40045	195
VINVZ7060	199	VRENO4810	114	VT8242032	175	VTB08070	198	VTEXBP60070	184	VTPOZ40050	195
VINVZ7070	199	VRENO4812	114	VT8248019	175	VTB08080	198	VTEXBP60080	184	VTPOZ40060	195
VMAE0630	325	VRENO4814	114	VT8248025	175	VTB08090	198	VTEXZP30016	185	VTPOZ45030	195
VMAE0825	325	VRENO4816	114	VT8248032	175	VTB08100	198	VTEXZP30020	185	VTPOZ45035	195
VMAE1030	325	VRENO4818	114	VT8248038	175	VTB10070	198	VTEXZP30025	185	VTPOZ45040	195
VMAR0420	325	VRENO4820	114	VT8255032	175	VTB10080	198	VTEXZP30030	185	VTPOZ45045	195
VMAR0630	325	VRENO4822	114	VT8255038	175	VTB10090	198	VTEXZP30040	185	VTPOZ45050	195
VMAR0830	325	VRENO4824	114	VT9650306Z	235	VTB10100	198	VTEXZP35016	185	VTPOZ45060	195
VMAI030	325	VRENO4830	114	VT9650310Z	235	VTBTS08	99	VTEXZP35020	185	VTPOZ45070	195
VMI08075	42	VRENO4835	114	VT9650408Z	235	VTBTS10	99	VTEXZP35025	185	VTPOZ50030	195
VMI08075	344	VRSE06020	325	VT9650410Z	235	VTBTS12	99	VTEXZP35030	185	VTPOZ50035	195
VMI08090	42	VRSE06030	325	VT9650416Z	235	VTCCA05025	97	VTEXZP35035	185	VTPOZ50040	195
VMI08090	344	VRSE08020	325	VT9650420Z	235	VTCCA05030	97	VTEXZP35040	185	VTPOZ50050	195
VMI10070	42	VRSE08030	325	VT9650425Z	235	VTCCA05035	97	VTEXZP35050	185	VTPOZ50060	195
VMI10070	344	VRSE10030	325	VT9650430Z	235	VTCCA05050	97	VTEXZP40025	185	VTPOZ50070	195
VMI10090	42	VRSE12030	325	VT9650510Z	235	VTCCA06035	97	VTEXZP40030	185	VTPOZ50080	195
VMI10090	344	VT8135009	174	VT9650516Z	235	VTCCA06040	97	VTEXZP40035	185	VTPOZ50090	195
VMI10120	42	VT8135013	174	VT9650520Z	235	VTCCA06050	97	VTEXZP40040	185	VTPOZ60060	195
VMI10120	344	VT8135016	174	VT9650530Z	235	VTCCA06060	97	VTEXZP40045	185	VTPOZ60070	195
VMI12110	42	VT8135019	174	VT9650540Z	235	VTCCA06070	97	VTEXZP40050	185	VTPOZ60080	195
VMI12110	344	VT8135025	174	VT9650610Z	235	VTCCA08060	97	VTEXZP40060	185	VTppo30016	193
VMIA408075	42	VT8139009	174	VT9650616Z	235	VTCCA08080	97	VTEXZP45030	185	VTppo30020	193
VMIA408075	345	VT8139013	174	VT9650620Z	235	VTEXA250050	187	VTEXZP45035	185	VTppo30025	193
VMIA410090	42	VT8139016	174	VT9650630Z	235	VTEXA250050	356	VTEXZP45040	185	VTppo30030	193

Ref	pág	Ref	pág	Ref	pág	Ref	pág	Ref	pág
VTPPO30040	193	VTPTO50035	196						
VTPPO35016	193	VTPTO50040	196						
VTPPO35020	193	VTPTO50050	196						
VTPPO35025	193	VTPTO50060	196						
VTPPO35030	193	VTPTO50070	196						
VTPPO35035	193	VTPTO50080	196						
VTPPO35040	193	VTPTO50090	196						
VTPPO35050	193	VTPTO60060	196						
VTPPO40016	193	VTPTO60070	196						
VTPPO40020	193	VTPTO60080	196						
VTPPO40025	193	VTUMAM03	241						
VTPPO40030	193	VTUMAM04	241						
VTPPO40035	193	VTUMAM05	241						
VTPPO40040	193	VTUMAM06	241						
VTPPO40045	193	VTUMAM08	241						
VTPPO40050	193	VTUMAM10	241						
VTPPO40060	193	VTUMAM12	241						
VTPPO45030	193								
VTPPO45035	193								
VTPPO45040	193								
VTPPO45045	193								
VTPPO45050	193								
VTPPO45060	193								
VTPPO45070	193								
VTPPO50030	193								
VTPPO50035	193								
VTPPO50040	193								
VTPPO50050	193								
VTPPO50060	193								
VTPPO50070	193								
VTPPO50080	193								
VTPPO50090	193								
VTPPO60040	193								
VTPPO60050	193								
VTPPO60060	193								
VTPPO60070	193								
VTPPO60080	193								
VTPPOTS05	99								
VTPPOTS06	99								
VTPPOTS08	99								
VTPTO30025	196								
VTPTO30030	196								
VTPTO35015	196								
VTPTO35020	196								
VTPTO35025	196								
VTPTO35030	196								
VTPTO35040	196								
VTPTO35050	196								
VTPTO40020	196								
VTPTO40025	196								
VTPTO40030	196								
VTPTO40035	196								
VTPTO40040	196								
VTPTO40045	196								
VTPTO40050	196								
VTPTO40060	196								
VTPTO45030	196								
VTPTO45035	196								
VTPTO45040	196								
VTPTO45045	196								
VTPTO45050	196								
VTPTO45060	196								
VTPTO45070	196								
VTPTO50030	196								



A series of horizontal dotted lines spanning the width of the page, intended for taking notes.

A series of horizontal dotted lines for taking notes, spanning the width of the page.

A
PERFECT
FIXING

CATINDEX25



Técnicas Expansivas S.L.

P. I. La Portalada II, C/ Segador, 13
26006 · Logroño (La Rioja) · SPAIN

T. (+34) 941.272.131 · E. info@indexfix.com
www.indexfix.com