



TU HERRAMIENTA

PRECIOS VÁLIDOS A PARTIR DEL
01/04/2024



2024



ESTUCHES DE HERRAMIENTAS

7

ESTUCHES DE HERRAMIENTAS
ESTUCHES DE VASOS
CAJAS / MALETAS DE HERRAMIENTAS
ESTUCHES DE PUNTAS
ESTUCHES MINI CON CARRACAS
ESTUCHES DE ADAPTADORES
SET DE VASOS
SET DE PUNTAS
HERRAMIENTAS AISLADAS



HERRAMIENTAS MANUALES

37

LLAVES
SARGENTOS
CARRACAS
LLAVES DINAMOMÉTRICAS
BARRAS DE EXTENSIÓN
DESTORNILLADORES
ALICATES
HERRAMIENTAS DE INSPECCIÓN
MARTILLOS
HERRAMIENTAS DE CORTE
CINCELES
REMACADORAS
MEDICIÓN
VARIOS



MOBILIARIO DE TALLER

71

CARROS DE HERRAMIENTAS
MÓDULOS DE HERRAMIENTAS
ACCESORIOS/RECAMBIOS
MESAS DE TRABAJO
ALMACENAMIENTO
TABURETES/CAMILLAS
YUNQUES/TORNILLOS DE BANCO



HERRAMIENTAS ELÉCTRICAS A BATERÍA

101

ATORNILLAR
TALADRAR
LIJAR/PULIR
SERRAR
HERRAMIENTAS ESPECIALES
HERRAMIENTAS PARA JARDINERÍA
BATERÍAS / CARGADORES
ACCESORIOS / CONSUMIBLES



ILUMINACIÓN

129

PORTÁTILES DE TALLER
FRONTALES
LINTERNAS
FOCOS
ILUMINACIÓN DE CAPÓ
GIROFAROS
FAROS DE TRABAJO
SEÑALIZACIÓN
ACCESORIOS Y RECAMBIOS



HERRAMIENTAS NEUMÁTICAS

145

ATORNILLAR
TALADRAR
CORTAR/SERRAR
LIJAR/PULIR
PISTOLAS DE AIRE
MANTENIMIENTO DE NEUMÁTICOS
OTROS
CARRETES/MANGUERAS
CONECTORES
ACCESORIOS Y CONSUMIBLES



ÚTILES, VASOS Y PUNTAS DE IMPACTO

167

SETS DE VASOS DE IMPACTO
ESPECIAL RUEDAS
ADAPTADORES
DESPIECE DE VASOS DE IMPACTO
ESPECIAL CAMIÓN



CARROCERÍA

179

PARA CHAPISTA
RESTAURACIÓN DE FAROS
SUSTITUCIÓN DE LUNAS
REPARACIÓN DE CHASIS
MOBILIARIO AUXILIAR
MANTENIMIENTO INTERIOR



FRENOS

193

REPOSICIONADORES
SANGRADORES
MANTENIMIENTO



UTILLAJE

199

SISTEMA DE LUBRICACIÓN
SISTEMA DE INYECCIÓN
BLOQUE/CULATA
EMBRAGUE
SISTEMA DE REFRIGERACIÓN
SISTEMA DE AIRE ACONDICIONADO
TRANSMISIÓN
SUSPENSIÓN
ESCAPE
SISTEMA ELÉCTRICO
REPARACIÓN DE ROSCAS
MOTO
EXTRACTORES



KITS DE CALADO (TIMING TOOLS)

243

FIAT/ALFA ROMEO
BMW/MINI
PSA
FORD
JAGUAR/LAND ROVER
JEEP/CHRYSLER

MERCEDES-BENZ
RENAULT/DACIA/NISSAN
OPEL/VAUXHALL
VAG
OTROS
HERRAMIENTAS AUXILIARES



ACCESORIOS LUBRICANTES

301

BOMBAS DE SUMINISTRO DE GASOIL
BOMBAS DE SUMINISTRO DE UREA
BOMBAS DE EXTRACCIÓN/LLENADO
RECOGEDORES DE ACEITE
PISTOLAS DE SUCCIÓN
CUBETOS RECOLECTORES DE ACEITE
OTROS



HERRAMIENTAS HIDRÁULICAS

313

GATOS CARRETILLA
GATOS BOTELLA
GATOS DE TRINQUETE
GATOS DE FOSO
CABALLETES
OTROS
TRANSPALETAS
PRENSAS
GRÚAS
MESAS ELEVADORAS
TACOS PARA ELEVADORES



HERRAMIENTAS ELÉCTRICAS

327

ARRANCADOR DE VEHÍCULO
MANTENIMIENTO DE LA BATERÍA
MEDICIÓN DE CORRIENTE
INSPECCIÓN VISUAL
SOLDADURA
EQUIPAMIENTO DE TALLER
CLIMATIZACIÓN
TERMÓMETROS
OTROS



ENERGÍA RENOVABLE Y MOVILIDAD DEL FUTURO

341

CABLES DE CARGA DE COCHE ELÉCTRICO
CARGADORES DE COCHE ELÉCTRICO
GENERADOR DE ENERGÍA
HERRAMIENTAS AISLADAS



ACCESORIOS DE TALLER

347

CARRETES
ESCALERAS
CARROS Y PLATAFORMAS



ACCESORIOS PARA VEHÍCULOS

353

SEÑALIZACIÓN
KITS DE EMERGENCIA
BOMBILLAS
BOTIQUINES
SEGURIDAD
FUELLES Y ABRAZADERAS
ALFOMBRAS
ESCOBILLAS
BICICLETA
OTROS
SENSORES DE PARKING
TUBOS FLEXIBLES



ACCESORIOS PARA NEUMÁTICOS

367

CONTRAPESAS
REPARACIÓN DE PINCHAZOS
VÁLVULAS DE NEUMÁTICO
EXTRACCIÓN E INSTALACIÓN



SEGURIDAD Y EPIS

373

GUANTES / EPIS
MASCARILLAS / DISPENSADORES
DELIMITACIÓN
MEDIDOR DE OZONO



CONSUMIBLES

381

PASADORES Y CIRCLIPS
REMACHES
TORNILLOS TUERCAS ARANDELAS
ARANDELAS DE CARTER Y MOTOR
OTROS
JUNTAS Y TÓRICAS
CONECTORES DE MANGUERA
ELÉCTRICOS
CLIPS Y GRAPAS DE PLÁSTICO



ROPA LABORAL

405

CHALECOS
CHAQUETAS



PROMOCIONALES

407

PRODUCTOS PROMOCIONALES
EXPOSITORES / ACCESORIOS
PACKAGING

JBM TU HERRAMIENTA

Tu marca de herramientas profesionales

Empresa líder especializada en la industria y la automoción

+7.000

PRODUCTOS
DISPONIBLES

+23.000

EUROPALLETS
EN STOCK

+68

EXPORTAMOS A
MÁS DE 68 PAÍSES

+550

PRODUCTOS
NUEVOS AL AÑO

MÁS DE 30 AÑOS DE EXPERIENCIA

En JBM somos especialistas en la distribución de herramientas y equipamiento de automoción, ofreciendo un servicio cercano y de calidad a nuestros más de 11.000 clientes repartidos en más de 68 países.

EXPERTOS EN DISTRIBUCIÓN Y LOGÍSTICA

JBM cuenta con una red logística en constante mejora que permite una distribución rápida y eficaz no solo en la península ibérica, sino también a todos los clientes internacionales.

AMPLIA GAMA DE PRODUCTOS

Ofrecemos una gama completa de más de 7.000 artículos en cajas de herramientas, maletines de herramientas, todo tipo de herramientas manuales, armarios de herramientas, utillaje de taller, iluminación, estuches de consumibles...



**SERVICIO
DE CALIDAD
AVALADO POR MÁS DE
11.000 CLIENTES**

**ENTREGAS
INTERNACIONALES
EXPORTAMOS A MÁS DE
68 PAÍSES**

**SEDE EN ESPAÑA Y
ALMACÉN DE MÁS DE
6.000M²**

ESTUCHES DE HERRAMIENTAS

- 9 ESTUCHES DE HERRAMIENTAS
- 17 ESTUCHES DE VASOS
- 24 CAJAS / MALETAS DE HERRAMIENTAS
- 28 ESTUCHES DE PUNTAS
- 32 ESTUCHES MINI CON CARRACAS
- 32 ESTUCHES DE ADAPTADORES
- 33 SET DE VASOS
- 34 SET DE PUNTAS
- 35 HERRAMIENTAS AISLADAS



HERRAMIENTAS DE ALTA CALIDAD PARA EL DÍA A DÍA

01

DISEÑADAS PARA UN
RENDIMIENTO ÓPTIMO EN
TODO TIPO DE TRABAJOS

02

MATERIAL RESISTENTE
CON ACABADOS DE ACERO
CROMADO DE ALTA CALIDAD

03

MANGO ERGONÓMICO DE
GRAN DIÁMETRO PARA UNA
MAYOR CAPACIDAD DE TORSIÓN



54034

178,00€

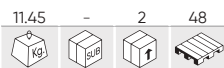

MALETÍN DE HERRAMIENTAS DE 216 PIEZAS CON VASOS HEXAGONALES CINCADO



CINCADO

54045

179,00€



MALETÍN DE HERRAMIENTAS DE 216 PIEZAS CON VASOS HEXAGONALES CROMADO



CROMADO



CONTIENE

	1/2" x14	13, 14, 15, 16, 17, 18, 19, 20, 21, 22, 24, 27, 30, 32mm
	3/8" x10	10, 11, 12, 13, 14, 15, 16, 17, 18, 19mm
	1/4" x13	4, 4.5, 5, 5.5, 6, 7, 8, 9, 10, 11, 12, 13, 14mm
	1/2" x5	16, 17, 18, 19, 22mm
	3/8" x6	10, 11, 12, 13, 14, 15mm
	1/4" x7	4, 5, 6, 7, 8, 9, 10mm
	1/2" x3	E20, E22, E24
	3/8" x6	E10, E11, E12, E14, E16, E18
	1/4" x5	E4, E5, E6, E7, E8
	1/2" x3	1/2" - 3/8" - 1/4"
	1/2" x2	125, 250mm
	3/8" x1	125mm
	1/4" x2	50, 100mm
	x3	1/2" - 3/8" - 1/4"
	1/2" x1	adaptador 3/8" (H) - 1/2" (M)
	1/2" x1	8mm
	3/8" x1	8mm
	1/4" x1	6mm

	1/2" x2	16, 21mm
	3/8" x1	18mm
	1/2" x12	8, 9, 10, 11, 12, 13, 14, 15, 16, 17, 18, 19mm
	1/2" x7	1.27, 1.5, 2, 2.5, 3, 4, 5mm
	1/4" x1	
	1/4" x1	
	1/4" x1	
	1/2" x1	T70
	1/2" x1	14mm
	x3	PH0, PH1, PH2
	x3	P20, P21, P22
	x4	3, 4, 5, 6mm
	x4	SL4, SL5.5, SL6.5, SL7
	x8	T8, T9, T10, T15, T20, T25, T27, T30
	x8	T8, T9, T10, T15, T20, T25, T27, T30

	8mm x4	7, 8, 10, 12mm
	6mm x6	2, 2.5, 3, 4, 5, 6mm
	8mm x3	SL8, SL10, SL12
	8mm x3	PH2, PH3, PH4
	8mm x3	P22, P23, P24
	8mm x5	T40, T45, T50, T55, T60
	6mm x3	T5, T6, T7
	8mm x5	T40, T45, T50, T55, T60
	6mm x1	T7
	8mm x4	M10, M11, M12, M13
	6mm x5	M5, M6, M7, M8, M9
	8mm x2	M10, M12
	6mm x3	M5, M6, M8
	8mm x1	TS50
	6mm x8	TS10, TS15, TS20, TS25, TS27, TS30, TS40, TS45
	x4	0, 1, 2, 3mm
	x3	6, 8, 10mm
	6mm x4	4, 6, 8, 10mm
	x3	1, 2, 3mm
	x4	1, 2, 3, 4mm
	6mm x1	1/4"

54250

188,00€



MALETÍN DE HERRAMIENTAS DE 216 PIEZAS CON VASOS DE 12 CANTOS CINCADO



CINCADO



DESPIECE DISPONIBLE



CONTIENE

	1/2" x14	13, 14, 15, 16, 17, 18, 19, 20, 21, 22, 24, 27, 30, 32mm
	3/8" x10	10, 11, 12, 13, 14, 15, 16, 17, 18, 19mm
	1/4" x13	4, 4.5, 5, 5.5, 6, 7, 8, 9, 10, 11, 12, 13, 14mm
	1/2" x5	16, 17, 18, 19, 22mm
	3/8" x6	10, 11, 12, 13, 14, 15mm
	1/4" x7	4, 5, 6, 7, 8, 9, 10mm
	1/2" x3	E20, E22, E24
	3/8" x6	E10, E11, E12, E14, E16, E18
	1/4" x5	E4, E5, E6, E7, E8
	1/2" x3	1/2" - 3/8" - 1/4"
	1/2" x2	125, 250mm
	3/8" x1	125mm
	1/4" x2	50, 100mm
	x3	1/2" - 3/8" - 1/4"
	1/2" x1	adaptador 3/8" (H) - 1/2" (M)

	1/2" x1	8mm
	3/8" x1	8mm
	1/4" x1	6mm
	1/2" x2	16, 21mm
	3/8" x1	18mm
	1/2" x12	8, 9, 10, 11, 12, 13, 14, 15, 16, 17, 18, 19mm
	1/2" x7	1.27, 1.5, 2, 2.5, 3, 4, 5mm
	1/4" x1	
	1/4" x1	
	1/4" x1	
	1/2" x1	T70
	1/2" x1	14mm
	x3	PH0, PH1, PH2
	x3	PZ0, PZ1, PZ2
	x4	3, 4, 5, 6mm
	1/4" x4	SL4, SL5.5, SL6.5, SL7
	x8	T8, T9, T10, T15, T20, T25, T27, T30
	x8	T8, T9, T10, T15, T20, T25, T27, T30

	8mm x4	7, 8, 10, 12mm
	6mm x6	2, 2.5, 3, 4, 5, 6mm
	8mm x3	SL8, SL10, SL12
	8mm x3	PH2, PH3, PH4
	8mm x3	PZ2, PZ3, PZ4
	8mm x5	T40, T45, T50, T55, T60
	6mm x3	T5, T6, T7
	8mm x5	T40, T45, T50, T55, T60
	6mm x1	T7
	8mm x4	M10, M11, M12, M13
	6mm x5	M5, M6, M7, M8, M9
	8mm x2	M10, M12
	6mm x3	M5, M6, M8
	8mm x1	TS50
	6mm x8	TS10, TS15, TS20, TS25, TS27, TS30, TS40, TS45
	x4	0, 1, 2, 3mm
	x3	6, 8, 10mm
	6mm x4	4, 6, 8, 10mm
	x3	1, 2, 3mm
	x4	1, 2, 3, 4mm
	6mm x1	1/4"

54082

189,00€

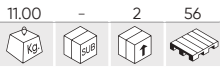

MALETÍN DE HERRAMIENTAS DE 132 PIEZAS CON VASOS HEXAGONALES CINCO



CINCO

DESPIECE
DISPONIBLE

ESPECIAL AUTOMOCIÓN



CONTIENE

	1/2" x7 19, 21, 22, 24, 27, 30, 32mm
	3/8" x12 8, 9, 10, 11, 12, 13, 14, 15, 16, 17, 18, 19mm
	1/4" x11 4, 5, 5.5, 6, 7, 8, 9, 10, 11, 12, 13mm
	3/8" x4 13, 14, 15, 17mm
	1/4" x4 8, 10, 12, 13mm
	3/8" x6 E8, E10, E11, E14, E16, E20
	1/2" x1
	3/8" x1
	1/4" x1
	1/2" x2 127, 254mm
	3/8" x2 76, 152mm
	1/4" x1 50mm
	x1 Ø14mm
	x1

	x1 3/8"(H) - 1/2"(M)
	x1 3/8"(H) - 1/2"(M)
	x1 3/8"(H) - 1/2"(M)
	1/2" x1
	3/8" x1
	1/4" x1
	1/2" x3 17, 19, 21mm
	1/4" x1 6mm
	x1
	x1 PH2x100
	x1 SL6x100
	x12 8, 9, 10, 11, 12, 13, 14, 15, 16, 17, 18, 19mm
	x1
	1/2" x1 H17
	x1

	1/2" x1 21mm
	3/8" x2 16, 18mm
	1/2" x1 T52
	1/2" x1 M16
	x2 5.5, 6.5mm
	x2 PH1, PH3
	3/8" x2 PZ1, PZ3
	x4 4, 5, 6, 8mm
	x6 T20, T30, T40, T45, T50, T55
	x3 4, 5, 6.5mm
	x3 PH1, PH2, PH3
	6mm x3 PZ1, PZ2, PZ3
	x4 3, 4, 5, 6
	x7 T10, T15, T20, T25, T27, T30, T40
	x9 1.5, 2, 2.5, 3, 4, 5, 6, 8, 10mm

54035

149,00€

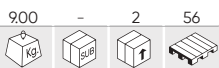

MALETÍN DE HERRAMIENTAS DE 179 PIEZAS CON VASOS HEXAGONALES CINCADO



CINCADO

54046

150,00€

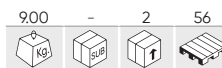

MALETÍN DE HERRAMIENTAS DE 179 PIEZAS CON VASOS HEXAGONALES CROMADO



CROMADO



DESPIECE DISPONIBLE



DESPIECE DISPONIBLE

CONTIENE

	1/2" x17	10, 11, 12, 13, 14, 15, 16, 17, 18, 19, 20, 21, 22, 24, 27, 30, 32mm
	3/8" x10	10, 11, 12, 13, 14, 15, 16, 17, 18, 19mm
	1/4" x13	4, 4.5, 5, 5.5, 6, 7, 8, 9, 10, 11, 12, 13, 14mm
	1/2" x5	16, 17, 18, 19, 22mm
	3/8" x6	10, 11, 12, 13, 14, 15mm
	1/4" x7	4, 5, 6, 7, 8, 9, 10mm
	1/2" x2	E20, E24
	3/8" x6	E10, E11, E12, E14, E16, E18
	1/4" x5	E4, E5, E6, E7, E8
	x3	1/2" - 3/8" - 1/4"
	1/2" x2	125, 250mm
	3/8" x1	125mm
	1/4" x2	50, 100mm

	x3	1/2" - 3/8" - 1/4"
	1/2" x2	16, 21mm
	3/8" x1	18mm
	1/2" x1	8mm
	3/8" x1	8mm
	1/4" x1	6mm
	x7	1.27, 1.5, 2, 2.5, 3, 4, 5mm
	x1	1/4"
	x1	1/4"
	x3	PH1, PH2, PH3
	x3	PZ1, PZ2, PZ3
	1/4" x5	2, 3, 4, 5, 6mm
	x3	SL4, SL5.5, SL7
	x8	T8, T9, T10, T15, T20, T25, T27, T30
	x8	T8, T9, T10, T15, T20, T25, T27, T30

	x11	T5, T6, T7, T8, T9, T10, T15, T20, T25, T27, T30
	x9	T7, T10, T15, T20, T25, T27, T30, T40, T45
	x5	M5, M6, M7, M8, M9
	x3	M5, M6, M8
	x2	PH3, PH4
	x2	PZ3, PZ4
	x5	7, 8, 10, 12, 14mm
	x3	SL8, SL10, SL12
	x6	T40, T45, T50, T55, T60, T70
	x6	T40, T45, T50, T55, T60, T70

54036

99,00€

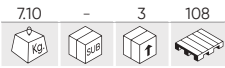

MALETÍN DE HERRAMIENTAS DE 113 PIEZAS
CON VASOS 12 CANTOS CINCADO



CINCADO

54047

100,00€

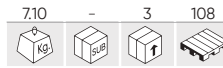

MALETÍN DE HERRAMIENTAS DE 113 PIEZAS
VASOS DE 12 CANTOS CROMADO



CROMADO

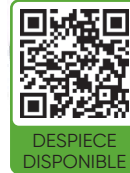

CONTIENE

	1/2"	x17	10, 11, 12, 13, 14, 15, 16, 17, 18, 19, 20, 21, 22, 24, 27, 30, 32mm
	1/4"	x13	4, 4.5, 5, 5.5, 6, 7, 8, 9, 10, 11, 12, 13, 14mm
	1/2"	x5	14, 15, 17, 19, 22mm
	1/4"	x8	6, 7, 8, 9, 10, 11, 12, 13mm
	1/2"	x8	E10, E11, E12, E14, E16, E18, E20, E24
	1/4"	x5	E4, E5, E6, E7, E8
	1/2"	x2	125, 250mm
	1/4"	x2	50, 100mm

		x2	1/2" - 1/4"
	1/2"	x1	adaptador 3/8" (H) - 1/2" (M)
	1/2"	x1	8mm
		x5	7, 8, 10, 12, 14mm
		x3	SL8, SL10, SL12
		x2	PH3, PH4
	8mm	x2	PZ3, PZ4
		x5	T40, T45, T50, T55, T60
		x5	5, 6, 8, 10, 12mm

	1/2"	x2	16, 21mm
		x3	1.5, 2, 2.5mm
		x1	1/4"
		x1	1/4"
		x2	PH1, PH2
		x2	PZ1, PZ2
	1/4"	x4	3, 4, 5, 6mm
		x3	SL4, SL5.5, SL6.5
		x7	T8, T10, T15, T20, T25, T27, T30

54037

88,00€



MALETÍN DE HERRAMIENTAS DE 108 PIEZAS CON VASOS HEXAGONALES CINCADO



CINCADO

54048

89,00€

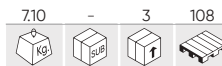

MALETÍN DE HERRAMIENTAS DE 108 PIEZAS CON VASOS HEXAGONALES CROMADO



CROMADO



DESPIECE DISPONIBLE



DESPIECE DISPONIBLE

CONTIENE

	1/2"	x17	10, 11, 12, 13, 14, 15, 16, 17, 18, 19, 20, 21, 22, 24, 27, 30, 32mm
	1/4"	x13	4, 4.5, 5, 5.5, 6, 7, 8, 9, 10, 11, 12, 13, 14mm
	1/2"	x5	14, 15, 17, 19, 22mm
	1/4"	x8	6, 7, 8, 9, 10, 11, 12, 13mm
	1/2"	x8	E10, E11, E12, E14, E16, E18, E20, E24
	1/4"	x5	E4, E5, E6, E7, E8
	1/2"	x2	1/2" - 1/4"
	1/2"	x2	125, 250mm
	1/4"	x2	50, 100mm
	1/2"	x2	1/2" - 1/4"
	1/2"	x1	adaptador 3/8" (H) - 1/2" (M)

	1/2"	x2	16, 21mm
	1/2"	x1	8mm
		x3	1.5, 2, 2.5mm
		x1	1/4"
		x1	1/4"
		x2	PH3, PH4
		x2	PZ3, PZ4
	8mm	x5	7, 8, 10, 12, 14mm
		x3	SL8, SL10, SL12
		x5	T40, T45, T50, T55, T60

		x2	PH1, PH2
		x2	PZ1, PZ2
	1/4"	x4	3, 4, 5, 6mm
		x3	SL4, SL5.5, SL6.5
		x7	T8, T10, T15, T20, T25, T27, T30

54038

88,00€

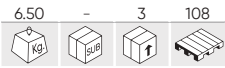

MALETIN DE HERRAMIENTAS DE 94 PIEZAS CON VASOS HEXAGONALES CINCADO



CINCADO

54049

89,00€

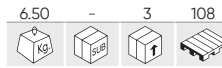

MALETÍN DE HERRAMIENTAS DE 94 PIEZAS CON VASOS HEXAGONALES CROMADO



CROMADO



CONTIENE

	1/2"	x18	10, 11, 12, 13, 14, 15, 16, 17, 18, 19, 20, 21, 22, 23, 24, 27, 30, 32mm
	1/4"	x13	4, 4.5, 5, 5.5, 6, 7, 8, 9, 10, 11, 12, 13, 14mm
	1/2"	x4	14, 15, 17, 19mm
	1/4"	x8	6, 7, 8, 9, 10, 11, 12, 13mm
	PH	x2	1/2" - 1/4"
	PH	x2	125, 250mm
	PH	x2	50, 100mm
	PH	x2	1/2" - 1/4"
	1/2"	x1	adaptador 3/8" (H) - 1/2" (M)

	1/2"	x1	8mm
		x3	1.5, 2, 2.5mm
	1/2"	x2	16, 21mm
		x2	PH3, PH4
		x2	PZ3, PZ4
	8mm	x4	8, 10, 12, 14mm
		x3	SL8, SL10, SL12
		x4	T40, T45, T50, T55
	8mm	x1	1/4"

		x1	1/4"
		x1	1/4"
		x1	1/4"
		x2	PH1, PH2
		x2	PZ1, PZ2
	1/4"	x4	3, 4, 5, 6mm
		x3	SL4, SL5.5, SL7
		x6	T8, T10, T15, T20, T25, T30

53212

174,00€

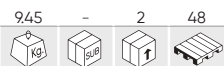

MALETÍN DE HERRAMIENTAS DE 303 PIEZAS CON VASOS HEXAGONALES CINCO

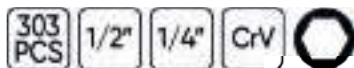

CINCO



CONTIENE

	x18	10, 11, 12, 13, 14, 15, 16, 17, 18, 19, 20, 21, 22, 23, 24, 27, 30, 32mm
	x2	125, 250mm
	x2	16, 21mm
	x1	8mm
	x1	adaptador 3/8" (H) - 1/2" (M)
	x1	UNIVERSAL
	x1	T2
	x13	4, 4.5, 5, 5.5, 6, 7, 8, 9, 10, 11, 12, 13, 14mm
	x2	50, 100mm
	x1	6,3mm
	x1	
	x1	UNIVERSAL
	x1	T2
	x8	T25, T27, T30, T35, T40 (x2), T45, T50
	x2	PH3, PH4
	x2	PZ3, PZ4
	x4	H5.5, H6.5, H7, H8
	x4	5.5, 6.5, 7, 8mm
	x4	5, 6, 8, 10mm

	x9	3, 4, 4.5, 5, 5.5, 6, 6.5, 7, 8mm
	x9	T8, T10, T15, T20, T25, T27, T30, T35, T40
	x9	H1.5, H2, H2.5, H3, H.4, H5, H5.5, H6, H8
	x3	5, 6, 8mm
	x4	1, 2, 3, 4
	x3	6, 8, 10
	x3	C1, C2, C3
	x6	2, 2.5, 3, 4, 5, 6mm
	x4	S0, S1, S2, S3
	x6	5/64, 3/32, 7/64, 1/8, 9/64, 5/32
	x4	4, 6, 8, 10mm
	x10	PH0 (x2), PH1 (x2), PH2 (x4), PH3 (x2)
	x10	PZ0 (x2), PZ1 (x2), PZ2 (x4), Z3 (x2)
	x10	1/16, 5/64, 3/32, 7/64, 1/8, 9/64, 5/32, 3/16, 7/32, 1/4
	x10	T8, T10, T15, T20, T25, T27, T30, T35, T40, T45
	x6	1.5, 2, 2.5, 3, 3.5, 4mm
	x4	PH000, PH00, PH0, PH1
	x2	PZ0, PZ1
	x8	T5, T6, T7, T8, T9, T10, T15, T20

	x1		x1	300g
	x1		x1	
	x10		x1	
	x1		x23	
	x1	3m		x22
	x1			x10
	x1	8"		x10
	x2	0.4x2.5, 0.5x3.0x50mm		
	x3	PH0x50, PH00x50, PH000x50mm		
	x2	0.8x4x100, 1.2x6.5x125mm		
	x2	PH1x80, PH2x100mm		
	x7	1.27, 1.5, 2, 2.5, 3, 4, 5mm		
	x13	1.5, 2, 2.5, 3, 3.2, 3.5, 4, 4.5, 4.8, 5, 5.5, 6, 6.5mm		



54106

89,00€

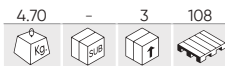

MALETÍN DE HERRAMIENTAS DE 37 PIEZAS EN PULGADA CINCO



CINCADO



DESPIECE DISPONIBLE

CONTIENE

	1/2" x17	5/16", 3/8", 7/16", 1/2", 9/16", 19/32", 5/8", 11/16", 3/4", 13/16", 7/8", 15/16", 1", 1-1/16", 1-1/8", 1-3/16", 1-1/4"		1/2" x2	5" - 10"
	1/4" x8	3/16", 7/32", 1/4", 9/32", 5/16", 11/32", 3/8", 7/16"		1/4" x1	3"
	x2	1/2" - 1/4"		x1	1/2" - 1/4"
	1/2" x2	16, 21mm		x2	1/2" - 1/4"
	1/2" x2	16, 21mm		x1	1/4"

53074

78,00€

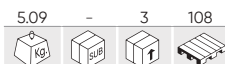

MALETÍN DE HERRAMIENTAS DE 74 PIEZAS CON VASOS DE 12 CANTOS CINCO

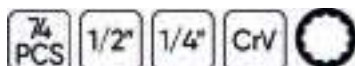

CINCADO



DESPIECE DISPONIBLE



CONTIENE

	1/2" x18	10, 11, 12, 13, 14, 15, 16, 17, 18, 19, 20, 21, 22, 23, 24, 27, 30, 32mm
	1/4" x10	4, 5, 5.5, 6, 7, 8, 10, 11, 12, 13mm
	x2	1/2" - 1/4"
	1/2" x2	125, 250mm
	1/4" x1	100mm
	x1	1/2"
	x5	PH0, PH1, PH2, PH3, PH4
	x5	PZ0, PZ1, PZ2, PZ3, PZ4
	x6	3, 4, 5, 6, 8, 10mm
	x5	SL3, SL4, SL5.5, SL6, SL7
	x8	T8, T10, T15, T20, T25, T27, T30, T40
	x4	4, 5, 6, 7mm
	1/2" x1	adaptador 3/8" (H) - 1/2" (M)
	1/2" x1	21mm
	x3	1.5, 2, 2.5mm
	x1	1/4"
	1/4" x1	6mm

54140

36,00€



ESTUCHE DE HERRAMIENTAS CON 56 PIEZAS CON VASOS DE 12 CANTOS CINCO



CINCADO



DESPIECE DISPONIBLE



CONTIENE

	x13	4, 4.5, 5, 5.5, 6, 7, 8, 9, 10, 11, 12, 13, 14mm
	x1	12
	x2	50, 100mm
	x1	1/4"
	x1	
	x1	
	x1	
	x1	
	x4	SL4, SL5, SL6, SL7
	x3	M5, M6, M8
	x8	T8, T10, T15, T20, T25, T27, T30, T40
	x8	T8, T10, T15, T20, T25, T27, T30, T40
	x3	PH0, PH1, PH2
	x3	PZ0, PZ1, PZ2
	x6	3, 4, 5, 6, 7, 8mm



54108

66,00€

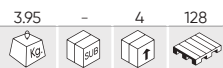

MALETÍN DE HERRAMIENTAS 22 PIEZAS
VASOS HEXAGONALES DE 1/2" CINCADO

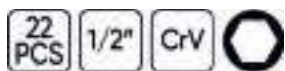

CINCADO



CONTIENE

	1/2"	x17	10, 11, 12, 13, 14, 15, 16, 17, 18, 19, 20, 21, 22, 24, 27, 30, 32mm
	1/2"	x1	
	1/2"	x2	75, 125mm
		x1	3/8" (H) - 1/2" (M)
		x1	1/2"

54116

66,00€



MALETÍN DE HERRAMIENTAS 22 PIEZAS
VASOS DE 12 CANTOS DE 1/2" CINCADO

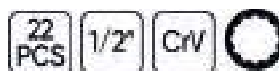

CINCADO



CONTIENE

	1/2"	x17	10, 11, 12, 13, 14, 15, 16, 17, 18, 19, 21, 22, 24, 27, 30, 32mm
		x1	1/2"
	1/2"	x2	125, 250mm
	1/2"	x1	
	1/2"	x1	3/8" (H) - 1/2" (M)

51818

109,00€



MALETÍN DE HERRAMIENTAS DE 72 PIEZAS CON VASOS HEXAGONALES CINCADO



CINCADO



CONTIENE

	1/2"	x13	10, 11, 12, 13, 14, 15, 17, 19, 22, 24, 27, 30, 32mm
	1/4"	x10	4, 5, 6, 7, 8, 9, 10, 11, 12, 13mm
	1/4"	x5	5, 6, 7, 8, 9mm
		x1	1/2"
		x1	1/4"
	1/2"	x1	125mm
	1/4"	x1	75mm

		x1	
		x1	300gr
		x1	
		x1	
		x4	SL3, SL4, SL5, SL6
	6mm	x3	PH1, PH2, PH3
		x7	T10, T15, T20, T25, T27, T30, T40

		x2	1/2" - 1/4"
	1/2"	x2	16, 21mm
	1/4"	x1	6mm
		x8	10, 11, 12, 13, 14, 15, 17, 19mm
		x3	1.5, 2, 2.5mm
		x1	1/4"
		x2	PH2x100, PH1x40mm
		x3	8x200, 6x100, 6x40mm

54258

58,00€

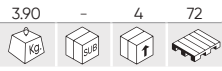

MALETÍN DE HERRAMIENTAS DE 77 PIEZAS CINCADO

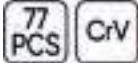

CINCADO



CONTIENE

	x5	PH0, PH1, PH2, PH2, PH3		x1
	x5	PZ0, PZ1, PZ2, PZ2, PZ3		x10
	x5	SL3, SL4, SL5, SL5.5, SL6mm		x1
	x5	T10, T15, T20, T25, T30		x1
	x4	6x7, 8x9, 10x11, 12x13mm		x1
	x9	1.5, 2, 2.5, 3, 4, 5, 6, 8, 10mm		x1
	x3	PH2x100, PH00x50, PH000x50		x1
	x3	SL6x100, SL2.5x50, SL3.0x50		x10
	x1			x10



54277

53,50€

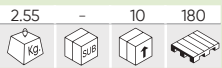

ESTUCHE DE HERRAMIENTAS DE 3/8" DE 59 PIEZAS CON VASOS HEXAGONALES CINCADO

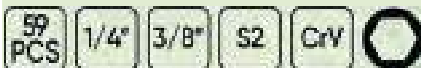

CINCADO



DESPIECE DISPONIBLE

CONTIENE

	3/8"	x17	6, 7, 8, 9, 10, 11, 12, 13, 14, 15, 16, 17, 18, 19, 20, 21, 22mm
	1/4"	x1	3/8"
	3/8"	x2	75, 150mm
	3/8"	x1	8mm
	3/8"	x1	8mm
		x1	3/8"
		x1	1/4"

	8mm	x2	PH3, PH4
		x2	PZ3, PZ4
		x5	7, 8, 10, 12, 14mm
		x3	SL8, SL10, SL12
		x5	T40, T45, T50, T55, T60

		x2	PH1, PH2
		x2	PZ1, PZ2
	1/4"	x4	3, 4, 5, 6mm
		x3	SL4, SL5.5, SL6.5
		x7	T8, T10, T15, T20, T25, T27, T30

53953

29,00€

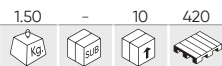

ESTUCHE DE VASOS Y PUNTAS DE 130 PIEZAS CINCADO



CINCADO



EN EXPOSITOR DE 10 UNIDADES



DESPIECE DISPONIBLE

CONTIENE

	1/4"	x13	4, 4.5, 5, 5.5, 6, 7, 8, 9, 10, 11, 12, 13, 14mm
	1/4"	x1	1/4"
	1/4"	x1	50mm
	1/4"	x1	1/4"
	1/4"	x1	6mm
	1/4"	x1	1/4"
	1/4"	x1	1/4"
	1/4"	x7	1.27, 1.5, 2, 2.5, 3, 4, 5mm

	25mm	x10	T8, T10, T15, T20, T25, T27, T30, T35, T40, T45
	25mm	x9	T8, T10, T15, T20, T25, T27, T30, T35, T40
	25mm	x3	M5, M6, M8
	25mm	x3	6, 8, 10mm
	25mm	x3	C1, C2, C3
	25mm	x4	1, 2, 3, 4mm
	25mm	x4	4, 6, 8, 10mm
	25mm	x4	0, 1, 2, 3mm

	25mm	x10	1/16, 5/64, 3/32, 7/64, 1/8, 9/64, 5/32, 3/16, 7/32, 1/4
	25mm	x9	1.5, 2, 2.5, 3, 4, 5, 5.5, 6, 8mm
	25mm	x6	5/64, 3/32, 7/64, 1/8, 9/64, 5/32
	25mm	x6	2, 2.5, 3, 4, 5, 6mm
	25mm	x9	3, 4, 4.5, 5, 5.5, 6, 6.5, 7, 8mm
	50mm	x2	4, 6mm
	25mm	x10	PH0(x2), PH1(x2), PH2(x4), PH3(x2)
	50mm	x2	PH1, PH2
	25mm	x10	P20(x2), PZ1(x2), PZ2(x4), PZ3(x2)

54109

34,00€



ESTUCHE DE 46 PIEZAS CON VASOS HEXAGONALES CINCADO

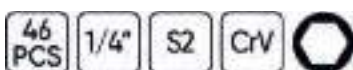

CINCADO



DESPIECE DISPONIBLE



CONTIENE

	1/4"	x13	4, 4.5, 5, 5.5, 6, 7, 8, 9, 10, 11, 12, 13, 14mm
	1/4"	x1	1/4"
	1/4"	x1	72
	1/4"	x1	
	1/4"	x2	50, 100mm
		x4	1.27, 1.5, 2.0, 2.5mm
		x1	
		x1	UNIVERSAL
		x1	1/4"
		x3	SL4, SL5.5, SL7
		x3	PH1, PH2, PH3
		x3	PZ1, PZ2, PZ3
		x6	H3, H4, H5, H6, H7, H8
		x6	T10, T15, T20, T25, T30, T40

54168

49,00€



ESTUCHE DE HERRAMIENTAS DE 3/8" DE 59 PIEZAS CON VASOS DE 12 CANTOS CINCADO

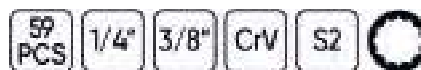

CINCADO



DESPIECE DISPONIBLE



CONTIENE

		x2	PH3, PH4
		x2	PZ3, PZ4
	8mm	x5	7, 8, 10, 12, 14mm
		x3	8, 10, 12mm
		x5	T40, T45, T50, T55, T60
		x2	PH1, PH2
		x2	PZ1, PZ2
	1/4"	x4	3, 4, 5, 6mm
		x3	4, 5.5, 6.5mm
		x7	T8, T10, T15, T20, T25, T27, T30
	3/8"	x17	6, 7, 8, 9, 10, 11, 12, 13, 14, 15, 16, 17, 18, 19, 20, 21, 22mm
	3/8"	x1	3/8"
	3/8"	x2	75, 150mm
	3/8"	x1	8mm
	3/8"	x1	8mm
	3/8"	x1	
	1/4"	x1	

54105

33,00€

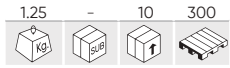

ESTUCHE DE HERRAMIENTAS CON 56 PIEZAS CON VASOS HEXAGONALES CINCADO



CINCADO



CONTIENE

		1/4"	x13	4, 4.5, 5, 5.5, 6, 7, 8, 9, 10, 11, 12, 13, 14mm
		1/4"	x1	1/4"
		1/4"	x2	50, 100mm
		1/4"	x1	1/4"
		1/4"	x1	1/4"
		1/4"	x1	1/4"
		1/4"	x1	6mm
			x3	PH0, PH1, PH2
		6mm	x3	PZ0, PZ1, PZ2
			x6	3, 4, 5, 6, 7, 8mm
			x4	SL4, SL5, SL6, SL7
			x3	M5, M6, M8
		6mm	x8	T8, T10, T15, T20, T25, T27, T30, T40
			x8	T8, T10, T15, T20, T25, T27, T30, T40
		6mm	x1	1/4"

52418

179,00€

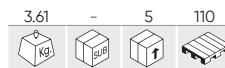

MALETÍN DE HERRAMIENTAS GO-THROUGH DE 39 PIEZAS CROMADO



CROMADO

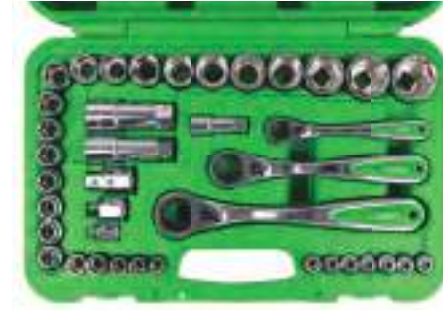

CONTIENE

		13mm	x12	4, 4.5, 5, 5.5, 6, 7, 8, 9, 10, 11, 12, 13mm
		19mm	x10	10, 11, 12, 13, 14, 15, 16, 17, 18, 19mm
		22mm	x5	20, 21, 22, 23, 24mm
		22mm	x3	27, 30, 32mm
		1/2"	x3	13, 19, 22mm
			x3	13, 19, 22mm
		1/4"	x1	13mm
		3/8"	x1	19mm
		1/2"	x1	22mm

54090

56,00€



ESTUCHE DE HERRAMIENTAS GO-THROUGH DE 14 PIEZAS CINCADO

CINCADO

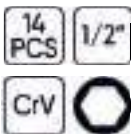

CONTIENE

	x11	13, 14, 15, 16, 17, 18, 19, 21, 22, 24, 27mm
	x1 (75mmL)	12,5mm
	x1	1/2"
	x1 (go-through)	

50623

60,00€



ESTUCHE DE 17 PIEZAS GO-THROUGH CROMADO

CROMADO

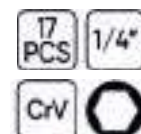

CONTIENE

		x13	4, 4.5, 5, 5.5, 6, 7, 8, 9, 10, 11, 12, 13, 14mm
		x1	75mm
		x1	1/4"
		x1	145mm

52722

87,00€



MALETÍN DE HERRAMIENTAS DE 61 PIEZAS VASOS SPLINE DE 1/2" Y 1/4" CINCADO



CINCADO



53108

92,00€



MALETÍN DE HERRAMIENTAS 61 PIEZAS VASOS SPLINE DE 1/2" Y 1/4" CROMADO



CROMADO



CONTIENE

	1/2" x11	14, 15, 16, 17, 18, 19, 22, 24, 27, 30, 32mm
	1/4" x12	4, 4.5, 5, 5.5, 6, 7, 8, 9, 10, 11, 12, 13mm
	x2	1/2" - 1/4"
	x2	5" - 10"
	x2	2" - 4"
	x2	1/2" - 1/4"

	x1	adaptador 3/8" (H) - 1/2" (M)
	x2	1/2" 16, 21mm
	x1	25mm
	x3	1.5, 2, 2.5mm
	x1	1/4"
	x1	1/4"
	x1	AD

	x3	PH1, PH2, PH3
	x3	PZ1, PZ2, PZ3
	x5	25mm 3, 4, 5, 6, 8mm
	x3	SL4, SL5.5, SL7
	x5	T10, T15, T20, T25, T30

53915

65,00€

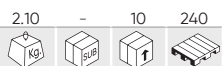

SET DE 6 VASOS 1/2" TORX TIPO E EXTRA LARGOS CINCADO

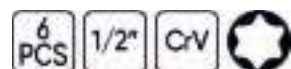

CINCADO

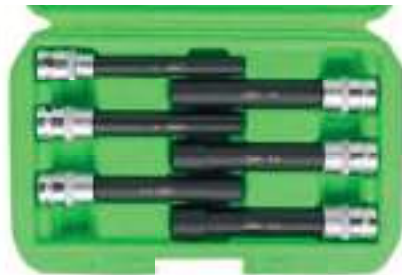

CONTIENE

	x6	1/2" 140mm E10, E12, E14, E16, E18, E20
--	----	---

E12 Llave de vaso para culata de BMW:
 - Motor M42, 1.8L , 4 cilindros, 16V, modelo 318 is desde 1989
 - Motor M50, 2.0L , 2.5L, 6 cilindros, 24V, modelo 520i, 525i desde 1991

54141

42,00€



SET 28 VASOS TORX CORTOS Y LARGOS CINCADO

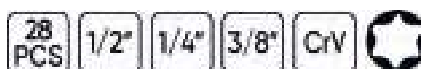

CINCADO



CONTIENE

	x5 (25mm)	E4, E5, E6, E7, E8
	x5 (28mm)	E10, E11, E12, E14, E16
	x4 (38mm)	E18, E20, E22, E24
	x5 (50mm)	E4, E5, E6, E7, E8
	x5 (63mm)	E10, E11, E12, E14, E16
	x4 (76mm)	E18, E20, E22, E24



51616

378,00€

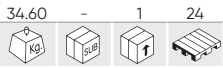

ESTUCHE METÁLICO CON 22 PIEZAS DE AUTOCLÉ DE 1" EN HEXAGONAL CINCADO

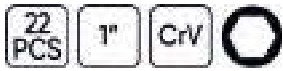

CINCADO



CAJA METÁLICA

CONTIENE

	1"	x17	36, 38, 41, 46, 50, 54, 55, 58, 60, 63, 65, 67, 70, 71, 75, 77, 80mm
	1"	x1	650mm
	1"	x2	205, 410mm
	1"	x1	
	1"	x1	



51855

378,00€



ESTUCHE METÁLICO CON 22 PIEZAS DE AUTOCLÉ DE 1" EN 12 CANTOS CINCADO



CINCADO



CAJA METÁLICA

CONTIENE

	1"	x17	36, 38, 41, 46, 50, 54, 55, 58, 60, 63, 65, 67, 70, 71, 75, 77, 80mm
	1"	x1	650mm
	1"	x2	205, 410mm
	1"	x1	
	1"	x1	



53727

198,00€

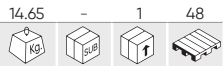

MALETÍN DE HERRAMIENTAS CON 21 PIEZAS 3/4" HEXAGONALES CINCADO

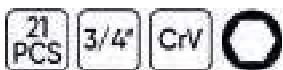

CINCADO



CONTIENE

	3/4"	x16	19, 21, 22, 23, 24, 26, 27, 29, 30, 32, 35, 36, 38, 41, 46, 50mm
	3/4"	x1	495mm
	3/4"	x3	100, 200, 400mm
	3/4"	x1	445mm



53728

198,00€



MALETÍN DE HERRAMIENTAS CON 21 PIEZAS 3/4" 12 CANTOS CINCADO

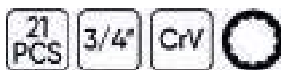

CINCADO



CONTIENE

	3/4"	x16	19, 21, 22, 23, 24, 26, 27, 29, 30, 32, 35, 36, 38, 41, 46, 50mm
	3/4"	x1	495mm
	3/4"	x3	100, 200, 400mm
	3/4"	x1	445mm



54261



321,00€

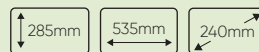

N

CAJA METÁLICA CON HERRAMIENTAS 143 PIEZAS CINCADO



CINCADO



DESPIECE DISPONIBLE

CONTIENE

		x13	4, 4.5, 5, 5.5, 6, 7, 8, 9, 10, 11, 12, 13, 14mm			x20	8, 9, 10, 11, 12, 13, 14, 15, 16, 17, 18, 19, 20, 21, 22, 23, 24, 27, 30, 32mm			x4	SL5x75, SL6x100, SL8x150, SL10x200mmL	
		x6	8, 10, 11, 12, 13, 14mm			x2	5" - 10"			x3	PH1x80, PH2x100, PH3x150mmL	
		x7	E4, E5, E6, E7, E8, E10, E11			$1/2"$	x2	16, 21mm			x4	PH1, PH2x2, PH3
		x2	2", 4"				x1	UNIVERSAL			x4	PZ1, PZ2x2, PZ3
		x1	110mmL				x1	3/8"(F) - 1/2"(M)			x4	SL3, SL4, SL5, SL6
		$1/4"$	x1			$1/2"$	x2				x4	H3, H4, H5, H6
		x1	150L			$1/4"$	x2				x7	T10, T15, T20, T25, T27, T30, T40
		x3	PH1,PH2,PH3								x7	TT10,TT15,TT20,TT25,TT27,TT30,TT40
		x3	SL4,SL5.5,SL6.5								x1	$1/4"$
		x6	TT10,TT15,TT20,TT25,TT30,TT40								x1	6.35mmx60mmL
		x6	H3,H4,H5,H6,H7,H8								x1	$1/4"$ -6.35mm
		x1									x1	7"-180mm
		x1	250mm								x1	7"-180mm
											x1	10"-250mm

53565

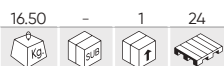

258,00€



CAJA DE HERRAMIENTAS DE HIERRO 64 PIEZAS CINCADO



CINCADO

CONTIENE

		$1/2"$	x18	10, 11, 12, 13, 14, 15, 16, 17, 18, 19, 20, 21, 22, 23, 24, 27, 30, 32mm			x1	$1/2"$
			x1	$1/2"$			x1	$1/2"$
		$1/2"$	x3	76, 127, 254mm			x1	$1/2"$
		$1/2"$	x1	255mm			x1	$1/2"$
		$1/2"$	x1	21mm			x1	457mm
			x1	457mm			x18	6, 7, 8, 9, 10, 11, 12, 13, 14, 15, 16, 17, 18, 19, 20, 21, 22, 24mm
			x9	1.5, 2, 2.5, 3, 4, 5, 6, 8, 10mm			x3	PH1x100, PH2x150, H3x200mm
			x3	PH1x100, PH2x150, H3x200mm			x3	SL5x100, SL6x150, SL8x200mm
			x1	250mm			x1	180mm
			x1	200mm			x1	180mm



DESPIECE DISPONIBLE

53159

289,00€

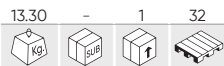

MALETA DE HERRAMIENTAS ALUMINIO 159 PIEZAS CINCADO



CINCADO



CONTIENE



	1/2" x14	14, 15, 16, 17, 18, 19, 20, 21, 22, 23, 24, 27, 30, 32mm
	1/4" x10	4, 5, 6, 7, 8, 9, 10, 11, 12, 13mm
	x2	1/4" - 1/2"
	1/2" x2	50, 100mm
	1/4" x2	125, 250mm
	1/4" x1	150mm
	x2	1/4" - 1/2"
	1/2" x1	adaptador 3/8" (H) - 1/2" (M)
	x2	1/4" - 1/2"
	1/4" x1	250mm
	1/4" x1	110mm
	1/2" x2	16, 21mm
	x1	1/4"

	x9	8, 10, 11, 12, 13, 15, 17, 19, 22mm
	x9	1.5, 2, 2.5, 3, 4, 5, 6, 8, 10mm
	x1	100-250V
	x1	
	x2	PH1x80, PH2x10mm
	x4	SL3x75, SL4x100, SL6.5x125, SL8x150mm
	x1	PH00x50mm
	x1	SL2.5x50mm
	x1	250mm
	x1	160mm
	x1	180mm
	x1	160mm
	x1	200mm
	x1	7" (180mm)
	x1	220mm
	x1	160mm

	x1	
	x6	1,5mm
	x1	
	x1	300gr
	x1	3m
	x1	200mm
	x5	
	x1	18mm
	x10	
	x40	6.35mm
	x15	8mm



53928

278,00€



MALETA DE HERRAMIENTAS DE 135 PIEZAS CON VASOS HEXAGONALES CINCADO



CINCADO



CONTIENE



	x10	10, 11, 12, 13, 14, 15, 17, 19, 22, 24mm
	x2	16, 21mm
	x1	UNIVERSAL
	x2	125, 250mm
	x1	3/8" - 1/2"
	x1	
	x9	4, 5, 6, 7, 8, 9, 10, 11, 12mm
	x1	UNIVERSAL
	x1	
	x2	50, 100mm
	x1	6mm
	x9	8, 10, 11, 12, 13, 14, 17, 19, 22mm
	x1	150mm
	x1	

	x4	PH1, PH2, PH2, PH3
	x4	PZ1, PZ2, PZ2, PZ3
	x4	SL3, SL4, SL5, SL6
	x4	H3, H4, H5, H6
	x7	TT10, TT15, TT20, TT25, TT27, TT30, TT40
	x7	TT10, TT15, TT20, TT25, TT27, TT30, TT40
	x1	6mm
	x1	6mmL
	x5	
	x1	
	x2	PH1x80mm, PH2x100mm, SL3.0x75mm, SL4.0x100mm, SL6.5x125mm, SL8x150mm
	x4	

	x1	
	x1	
	x3	SL1.5, SL2, SL3
	x4	PH000, PH00, PH0, PH1
	x8	T4, T5, T6, T7, T8, T10, T15, T20
	x4	TS0.8, TS1.2, TS1.5, TS2.0
	x1	H2.0
	x1	
	x1	
	x9	1.5, 2, 2.5, 3, 4, 5, 6, 8, 10mm
	x1	
	x1	5m
	x1	300g

	x1	250mm
	x1	180mm
	x1	180mm
	x1	200mm
	x1	160mm
	x1	200mm
	x1	
	x3	
	x1	18mm

53444

195,00€

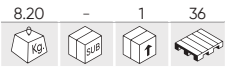

MALETA DE HERRAMIENTAS DE ALUMINIO 108 PIEZAS VASOS 1/2" CINCADO

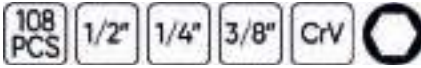

CINCADO

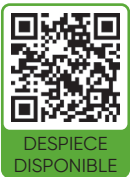

CONTIENE



	x9	10, 11, 12, 13, 14, 15, 17, 18, 19mm
	x2	75, 150mm
	x1	16mm
	x1	Ⓢ
	x1	adaptador 3/8" (H) - 1/2" (M)
	x8	4, 4.5, 5, 5.5, 6, 7, 8, 9mm
	x1	150mmL
	x1	6mm
	x2	PH1x80, PH2x100mm
	x4	SL3.5x75, SL4x100, SL6.5x125, SL8x150mm
	x1	PH00x50mm
	x1	SL2.5x50mm
	x1	

	x9	6x7, 8x9, 10x11, 12x13, 14x15, 16x17, 18x19, 20x22mm
	x9	1.5, 2, 2.5, 3, 4, 5, 6, 8, 10mm
	x1	
	x6	
	x1	200mm
	x1	18mm
	x10	
	x1	220mm
	x1	180mm
	x1	160mm
	x1	250mm
	x1	160mm

	x30	
	x1	
	x1	300g
	x1	3m



52603

74,00€

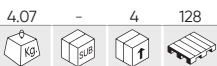

MALETÍN DE PUNTAS PARA TORNILLOS DE 12 CANTOS 26 PIEZAS

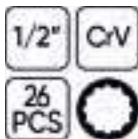

DESPIECE DISPONIBLE

CONTIENE

	x8 (55mmL)	M5, M6, M8, M9, M10, M12, M14, M16
	x7 (100mmL)	M5, M6, M8, M9, M10, M12, M14
	x7 (140mmL)	M5, M6, M8, M9, M10, M12, M14
	x4 (200mmL)	M8, M10, M12, M14

52606

88,00€



MALETÍN DE PUNTAS PARA TORNILLOS RIBE 32 PIEZAS

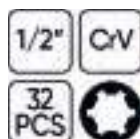

DESPIECE DISPONIBLE

CONTIENE

	x9 (55mmL)	M5, M6, M7, M8, M9, M10, M12, M13, M14
	x9 (100mmL)	M5, M6, M7, M8, M9, M10, M12, M13, M14
	x7 (140mmL)	M7, M8, M9, M10, M12, M13, M14
	x7 (200mmL)	M7, M8, M9, M10, M12, M13, M14

52604

78,00€

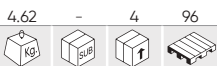

MALETÍN DE PUNTAS HEXAGONALES 30 PIEZAS



DESPIECE DISPONIBLE

CONTIENE

	x9 (55mmL)	5, 6, 7, 8, 10, 12, 14, 17, 19mm
	x8 (100mmL)	5, 6, 7, 8, 10, 11, 12, 13mm
	x7 (140mmL)	5, 6, 7, 8, 10, 12, 14mm
	x6 (200mmL)	5, 6, 7, 8, 10, 12mm

52605

76,00€



MALETÍN DE PUNTAS PARA TORNILLOS TORX 32 PIEZAS

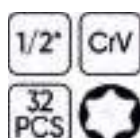

DESPIECE DISPONIBLE

CONTIENE

	x10 (55mmL)	T20, T25, T27, T30, T40, T45, T50, T55, T60, T70
	x10 (100mmL)	T20, T25, T27, T30, T40, T45, T50, T55, T60, T70
	x6 (140mmL)	T40, T45, T50, T55, T60, T70
	x6 (200mmL)	T40, T45, T50, T55, T60, T70

54266

39,50€

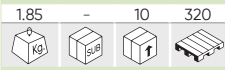

N

MALETÍN DE VASOS Y PUNTAS TORX DE 1/2" 19 PIEZAS



CONTIENE

	x9	E10, E11, E12, E14, E16, E18, E20
	x10	T20, T25, T27, T30, T40, T45, T50, T55, T60, T70



DESPIECE DISPONIBLE

54154

37,50€



SET 12 PIEZAS 1/2" PUNTA TORX



CONTIENE

	x6	T20, T25, T30, T40, T45, T50
	x6	T55, 60, T70, T80, T90, T100



DESPIECE DISPONIBLE

51260

37,00€

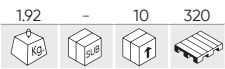

SET DE 12 PIEZAS DE 1/2" PUNTA HEXAGONAL



CONTIENE

	x6	H5, H6, H7, H8, H10, H12
	x1	H14
	x5	H16, H17, H18, H19, H20



DESPIECE DISPONIBLE

54164

34,00€



SET DE 12 PIEZAS DE 1/2" PUNTA 12 CANTOS



CONTIENE

	x6 (55mmL)	M4, M5, M6, M8, M9
	x6 (70mmL)	M10, M12, M14, M16, M18, M20



DESPIECE DISPONIBLE

50983

48,00€



MALETÍN DE 42 PIEZAS HEXAGONALES, 12 CANTOS Y TORX



CONTIENE

	3/8"	x1	10mm
	1/2"	x1	10mm
	30mm	x7	4, 5, 6, 7, 8, 10, 12mm
	75mm	x7	4, 5, 6, 7, 8, 10, 12mm
	30mm	x8	T20, T25, T30, T40, T45, T50, T55, T60
	75mm	x8	T20, T25, T30, T40, T45, T50, T55, T60
	30mm	x5	M5, M6, M8, M10, M12
	75mm	x5	M5, M6, M8, M10, M12



DESPIECE DISPONIBLE

50985

59,00€



MALETÍN DE 42 PIEZAS DE 12 Y 6 CANTOS INVOLABLES



CONTIENE

	3/8"	x1	10mm
	1/2"	x1	10mm
	30mm	x7	4, 5, 6, 7, 8, 10, 12mm
	75mm	x7	4, 5, 6, 7, 8, 10, 12mm
	30mm	x8	T20, T25, T30, T40, T45, T50, T55, T60
	75mm	x8	T20, T25, T30, T40, T45, T50, T55, T60
	30mm	x5	M5, M6, M8, M10, M12
	75mm	x5	M5, M6, M8, M10, M12



DESPIECE DISPONIBLE

52550

92,00€



MALETÍN DE PUNTAS 75 PIEZAS HEXAGONALES, XZN, RIBE, TORX Y TORX INV.

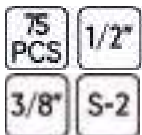

DESPIECE DISPONIBLE

CONTIENE

	3/8"	x1	10mm
	1/2"	x2	10mm
	30mm	x7	4, 5, 6, 7, 8, 10, 12mm
	75mm	x7	4, 5, 6, 7, 8, 10, 12mm
	30mm	x8	T20, T25, T30, T40, T45, T50, T55, T60
	75mm	x8	T20, T25, T30, T40, T45, T50, T55, T60
	30mm	x5	M5, M6, M8, M10, M12
	75mm	x5	M5, M6, M8, M10, M12
	30mm	x8	R5, R6, R7, R8, R9, R10, R12, R14
	75mm	x8	R5, R6, R7, R8, R9, R10, R12, R14
	30mm	x8	TT20, TT25, TT30, TT40, TT45, TT50, TT55, TT60
	75mm	x8	TT20, TT25, TT30, TT40, TT45, TT50, TT55, TT60

52753

107,00€



MALETÍN DE PUNTAS 55 PIEZAS HEAVY DUTY



DESPIECE DISPONIBLE

CONTIENE

	3/8"	x1	10mm
	1/2"	x2	10, 14mm
	30mm	x9	4, 5, 6, 7, 8, 10, 12, 14, 16mm - ISO 2136
	75mm	x9	4, 5, 6, 7, 8, 10, 12, 14, 16mm - ISO 2136
	30mm	x10	T20, T25, T30, T40, T45, T50, T55, T60, T70, T80 - DIN 2325
	75mm	x10	T20, T25, T30, T40, T45, T50, T55, T60, T70, T80 - DIN 2325
	30mm	x7	M5, M6, M8, M10, M12, M14, M16 - DIN 2325
	75mm	x7	M5, M6, M8, M10, M12, M14, M16 - DIN 2325

52539

59,00€

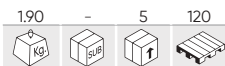

ESTUCHE DE PUNTAS EN SURTIDO



CONTIENE

	x10	PH3, PH4
	x10	PZ3, PZ4
	x25	7, 8, 10, 12, 14mm
	x15	SL8, SL10, SL12
	x25	T40, T45, T50, T55, T60



52538

62,00€



ESTUCHE PUNTAS DESTORNILLADOR SURTIDO DE 1/4"



CONTIENE

	x10	PH1, PH2
	x10	PZ1, PZ2
	x20	3, 4, 5, 6mm
	x15	SL4, SL5.5, SL6.5
	x35	T8, T10, T15, T20, T25, T27, T30



53574

47,00€



MALETÍN DE PUNTAS DE 208 PIEZAS

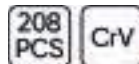

CONTIENE

	x12	1.5, 2, 2.5, 3, 3.5, 4, 4.5, 5, 5.5, 6, 7, 8mm
	x10	1/16, 5/64, 3/32, 7/64, 1/8, 9/64, 5/32, 3/16, 7/32, 1/4
	x5	2.5, 3, 4, 5, 6mm
	x5	2.5, 3, 4, 5, 6mm
	x18	PH00, PH0, PH1(x5), PH2(x5), PH3(x5), PH4
	x3	PH1, PH2, PH3
	x3	PH1, PH2, PH3
	x17	PZ00, PZ0, PZ1(x5), PZ2(x5), PZ3(x4), PZ4
	x3	PZ1, PZ2, PZ3
	x3	PZ1, PZ2, PZ3
	x14	T5, T6, T7, T8, T9, T10, T15, T20, T25, T27, T30, T35, T40, T45
	x7	T10, T15, T20, T25, T27, T30, T40
	x7	T10, T15, T20, T25, T27, T30, T40

	x3	6, 8, 10mm
	x3	6, 8, 10mm
	x4	4, 6, 8, 10mm
	x4	4, 6, 8, 10mm
	x4	1, 2, 3, 4mm
	x4	1, 2, 3, 4mm
	x6	2, 2.5, 3, 4, 5, 6mm
	x6	5/64, 3/32, 7/64, 1/8, 9/64, 5/32
	x13	T5, 6, 7, 8, 9, 10, 15, 20, 25, 27, 30, 40, 45
	x3	1, 2, 3mm
	x4	0, 1, 2, 3mm
	x3	M5, M6, M8
	x9	TS10, TS15, TS20, TS25, TS27, TS30, TS40, TS45, TS50

	x12	SL2, SL2.5, SL3, SL3.5, SL4, SL4.5, SL5, SL5.5, SL6, SL6.5, SL7, SL8
	x10	4, 5, 6, 7, 8, 9, 10, 11, 12, 13
	x10	5/32, 3/16, 7/32, 1/4, 9/32, 5/16, 11/32, 3/8, 7/16, 1/2
	x1	1/4"
	x1	
	x1	



52620

8,80€



PORTAPUNTAS ANGULAR



- Para zonas de difícil acceso.
- Con función de enchufe rápido.
- Fácil de extraer.
- Broca de 6mm.

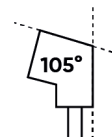

53156

26,20€

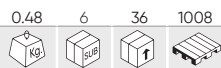

ESTUCHE DE 38 PIEZAS CON CARRACA MINI DE 1/4"



DESPIECE DISPONIBLE



CONTIENE

	1/4"	x11	4, 4.5, 5, 6, 7, 8, 9, 10, 11, 12, 13mm		6mm	x5	4, 5, 6, 7, 8mm
	1/4"	x1			6mm	x3	SL6, SL8, SL10
		x2	PH3, PH4		6mm	x8	T8, T9, T10, T15, T20, T25, T30, T40
		x2	PZ3, PZ4		6mm	x4	M5, M6, M9, M10
		x1	1/4"			x1	1/4"

52198

37,70€



ESTUCHE DE 38 PIEZAS CON CARRACA MINI DE 1/4"



DESPIECE DISPONIBLE



CONTIENE

	1/4"	x11	4, 4.5, 5, 6, 7, 8, 9, 10, 11, 12, 13mm		6mm	x5	4, 5, 6, 7, 8mm
	1/4"	x1			6mm	x3	SL6, SL8, SL10
		x2	PH3, PH4		6mm	x8	T8, T9, T10, T15, T20, T25, T30, T40
		x2	PZ3, PZ4		6mm	x4	M5, M6, M9, M10
		x1	1/4"			x1	1/4"

51333

18,00€

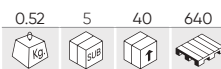

ESTUCHE DE 6 ADAPTADORES



DESPIECE DISPONIBLE

REF.	mm				€
11360	1/4H - 3/8M	0.03	10	100	2,60€
11361	1/4M - 3/8H	0.03	5	300	3,20€
11362	1/2H - 3/4M	0.14	10	100	5,20€
11363	3/8H - 1/2M	0.50	10	100	3,90€
11364	1/2H - 3/8M	0.05	10	100	4,50€
11365	3/4H - 1/2M	0.14	10	100	9,40€

53743

39,70€



ESTUCHE DE 6 ADAPTADORES DE IMPACTO



DESPIECE DISPONIBLE

REF.	mm				€
14749	1/4"H - 3/8"M	0.03	20	200	2,00€
14750	3/8"H - 1/4"M	0.05	20	100	2,00€
14751	3/8"H - 1/2"M	0.15	20	100	4,00€
14752	1/2"H - 3/8"M	0.16	10	100	4,00€
11962	1/2"H - 3/4"M	0.17	10	100	7,50€
11964	3/4"H - 1/2"M	0.35	10	100	12,50€

52714 15,70€

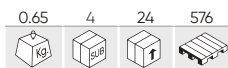

JUEGO DE VASOS 1/2" HEXAGONALES



52716 15,90€

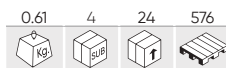

JUEGO DE VASOS 1/2" 12 CANTOS

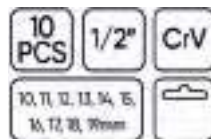

52715 10,00€



JUEGO DE VASOS 1/4" HEXAGONALES



52717 11,00€



JUEGO DE VASOS 1/4" 12 CANTOS

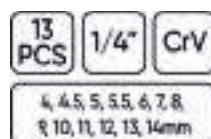

51410 36,00€



SET DE 6 PIEZAS DE 1/2" PUNTA TORX INVOLABLE

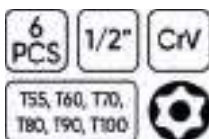

51409 36,00€



SET DE 6 PIEZAS DE 1/2" PUNTA 12 CANTOS INVOLABLE / PUNTA XZN



52909

12,50€

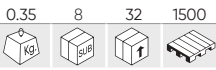

JUEGO DE PUNTAS 1/4" 18 PCS



CONTIENE

	x2	PH1, PH2		x3	SL4, SL5.5, SL6.5
	x2	PZ1, PZ2		x7	T8, T10, T15, T20, T25, T27, T30
	x4	3, 4, 5, 6mm			

DESPIECE DISPONIBLE

52908

17,00€

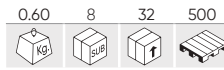

JUEGO DE PUNTAS 1/4" 30 PCS



CONTIENE

	x3	PH0, PH1, PH2		x4	SL4, SL5.5, SL6.5, SL7
	x3	PZ0, PZ1, PZ2		x8	T8, T9, T10, T15, T20, T25, T27, T30
	x4	3, 4, 5, 6mm		x8	T8, T9, T10, T15, T20, T25, T27, T30

DESPIECE DISPONIBLE

53084

24,00€

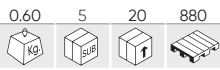

JUEGO DE 7 PUNTAS TORX DE 3/8" Y 1/2"



DESPIECE DISPONIBLE

	x2	T55, T60, T70		x5	T30, T40, T45, T50
--	----	---------------	--	----	--------------------

53127

12,00€

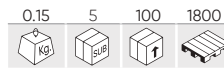

JUEGO DE 7 PUNTAS TORX INVIOLEABLE 1/4"

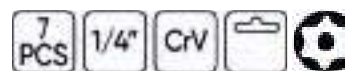

DESPIECE DISPONIBLE

	x7	T10, T15, T20, T25, T30, T40, T45
--	----	-----------------------------------

51746

12,00€

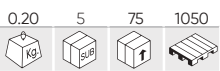

JUEGO DE PUNTAS TS 5 CARAS INVIOLEABLE



50980

22,00€

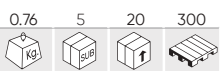

JUEGO DE PUNTAS RIBE



	x3	100mm	M12, M13, M14
	x4	90mm	M6, M7, M8, M10

50982

22,00€

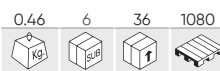

JUEGO DE PUNTAS DE BOLA



	x7	100mm
	x7	4, 5, 6, 7, 8, 10mm

52320

22,00€

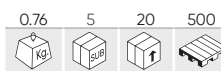

JUEGO DE PUNTAS DE 12 CANTOS



	x3	100mm	M12, M13, M14
	x4	90mm	M6, M7, M8, M10

12029

5,50€

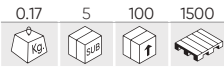

VASO PUNTA 1/2" XZN INVIOLABLE M16X58MM ESP. VAG



12030

6,50€

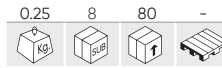

VASO PUNTA 1/2" XZN INVIOLABLE M16X100MM ESP. VAG

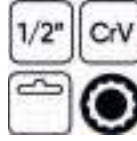

PUNTA EXTRALARGA DE 12 CANTOS 800MM DE 1/2"

REF.	DESCRIPCIÓN					€
52059	Ø 8mm - 800mm	0.57	-	25	1750	29,00€
52060	Ø 10mm - 800mm	0.57	-	25	1750	32,00€
53667	Ø 12mm - 800mm	0.80	10	20	-	32,00€
53668	Ø 14mm - 800mm	1.05	10	20	-	34,00€



54091

441,00€



MALETÍN DE HERRAMIENTAS AISLADAS VDE 26 PCS



54093

441,00€



MÓDULO EVA DE HERRAMIENTAS AISLADAS VDE 26 PCS

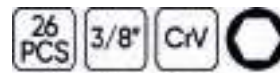
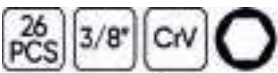

CONTIENE

	3/8" x10	8, 10, 11, 12, 13, 14, 16, 17, 18, 19, 21, 22mm
	3/8" x1	200mm
	1/2" x1	125mm
	3/8" x1	200mm

	x2	4x100mmL, 5,5x125mmL
	x2	PH1x80mm, PH2x100mm
	x1	185mm
	x1	

	x6	7x86, 8x99, 10x109, 12x127, 14x141, 17x156mm
	x1	185mm

15162



SET DE 8 DESTORNILLADORES AISLADOS VDE EN MÓDULO EVA FIBRA DE CARBONO



DESPIECE DISPONIBLE

REF.	Ø	kg	SUP	PCS	€
15227	0.5x3.0x75mm	0,02	10	50	3,50€
15228	0.8x4.0x100mm	0,05	10	50	4,00€
15229	1.0x5.5x125mm	0,08	5	50	5,00€
15230	1.2x6.5x150mm	0,11	5	50	5,00€
15231	PH0x75mm	0,02	10	50	3,50€
15232	PH1x80mm	0,05	10	50	4,00€
15233	PH2x100mm	0,08	5	50	5,00€
15234	Comprobador de corriente 140mm	0,02	10	50	3,00€

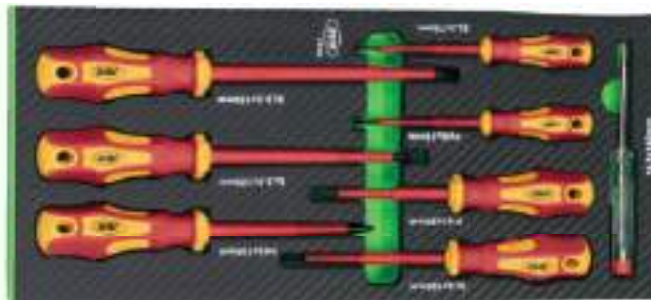

- ⊖ x4 0.5x3.0x75, 0.8x4.0x100, 1.0x5.5x125, 1.2x6.5x150mm
- ⊕ x3 PH0x75, PH1x80, PH2x100mm
- 🔍 x1 SL3x140mm

53154

462,00€



MALETÍN DE HERRAMIENTAS AISLADAS 20 PCS DE 3/8"



CONTIENE

🔧	3/8"	x12	8, 10, 11, 12, 13, 14, 16, 17, 18, 19, 21, 22mm
🔧	3/8"	x1	200mm
🔧	3/8"	x2	125, 250mm
🔧	3/8"	x1	200mm
🔧	3/8"	x4	75mm 4, 5, 6, 8mm

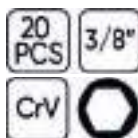

52519

25,50€



SET DE 7 DESTORNILLADORES AISLADOS 1.000V

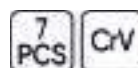

CONTIENE

- ⊕ x2 PH00x50, PH0x50mm
- ⊖ x5 SL1.5x0.23x50, SL1.8x0.30x50, SL2.0x0.40x50, SL2.5x0.40x50, SL3.0x0.50x50mm

CUCHILLO AISLADO

REF.	DESCRIPCIÓN	kg	SUP	PCS	€
53164	RECTO	0.10	6	36	16,50€
53165	CURVADO	0.10	6	36	19,60€



HERRAMIENTAS MANUALES

- 38 LLAVES
- 48 SARGENTOS
- 49 CARRACAS
- 51 LLAVES DINAMOMÉTRICAS
- 53 BARRAS DE EXTENSIÓN
- 53 DESTORNILLADORES
- 56 ALICATES
- 62 HERRAMIENTAS DE INSPECCIÓN
- 63 MARTILLOS
- 64 HERRAMIENTAS DE CORTE
- 65 CINCELES
- 66 REMACHADORAS
- 68 MEDICIÓN
- 69 VARIOS



54101

61,00€

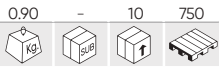

SET DE 6 LLAVES CON TRINQUETE



8x9, 10x11, 12x13,
14x15, 16x18, 17x19mm



DESPIECE DISPONIBLE

REF.	mm	Kg	SUB	QTY	€
15632	8x9	0.04	10	100	9,00€
15633	10x11	0.07	10	100	9,50€
15634	12x13	0.11	10	100	11,00€

REF.	mm	Kg	SUB	QTY	€
15635	14x15	0.13	10	100	12,50€
15636	16x18	0.19	10	100	14,00€
15637	17x19	0.25	10	100	15,00€

53017

57,00€

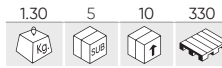

SET DE 7 LLAVES COMBINADAS ARTICULADAS CON TRINQUETE



8, 10, 11, 13,
14, 12, 19 mm



DESPIECE DISPONIBLE

REF.	mm	Kg	SUB	QTY	€
10552	8	0.06	10	100	7,10€
10554	10	0.09	10	100	7,50€
10555	11	0.09	10	100	7,80€
10557	13	0.13	10	100	8,10€

REF.	mm	Kg	SUB	QTY	€
10558	14	0.14	5	100	9,35€
10561	17	0.22	10	100	11,00€
10563	19	0.28	10	100	12,50€

54117

74,00€

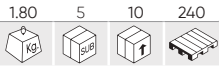

SET DE 12 LLAVES COMBINADAS CON TRINQUETE



8, 9, 10, 11, 12, 13, 14, 15,
16, 17, 18, 19 mm



DESPIECE DISPONIBLE

REF.	mm	Kg	SUB	QTY	€
13465	8	0.05	10	100	5,55€
13466	9	0.06	10	100	5,55€
13467	10	0.10	10	100	6,00€
13468	11	0.08	10	100	6,25€
13469	12	0.09	10	100	6,25€
13470	13	0.10	10	100	6,60€

REF.	mm	Kg	SUB	QTY	€
13471	14	0.11	10	100	6,90€
13472	15	0.13	10	100	7,25€
13473	16	0.15	10	100	8,10€
13474	17	0.19	10	100	8,70€
13475	18	0.22	10	100	9,10€
13476	19	0.22	10	100	9,60€

51318

98,00€

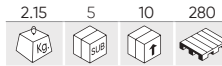

SET DE 12 LLAVES COMBINADAS ARTICULADAS CON TRINQUETE



8, 9, 10, 11, 12, 13, 14,
15, 16, 17, 18, 19 mm



DESPIECE DISPONIBLE

REF.	mm	Kg	SUB	QTY	€
10552	8	0.06	10	100	7,10€
10553	9	0.07	10	100	7,35€
10554	10	0.09	10	100	7,50€
10555	11	0.09	10	100	7,80€
10556	12	0.11	10	100	8,10€
10557	13	0.13	10	100	8,10€

REF.	mm	Kg	SUB	QTY	€
10558	14	0.14	5	100	9,35€
10559	15	0.16	10	100	9,50€
10560	16	0.19	5	50	10,60€
10561	17	0.22	10	100	11,00€
10562	18	0.26	5	100	12,30€
10563	19	0.28	10	100	12,50€

54338

60,00€

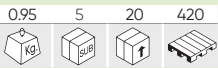

LLAVE CON TRINQUETE CON CABEZAL INTERCAMBIABLE 12 PCS

DESPIECE DISPONIBLE

REF.	mm				€	REF.	mm				€
16391	8	0.01	30	100	4,60€	16397	14	0.05	30	100	5,50€
16392	9	0.05	30	100	4,60€	16398	15	0.05	30	100	5,50€
16393	10	0.05	30	100	4,60€	16399	16	0.05	30	100	5,50€
16394	11	0.05	30	100	5,10€	16401	17	0.05	30	100	6,10€
16395	12	0.05	30	100	5,10€	16402	18	0.05	30	100	6,10€
16396	13	0.05	30	100	5,10€	16403	19	0.10	30	100	6,10€



N

15316

58,00€

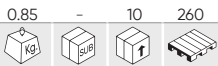

MÓDULO DE 3 LLAVES 72 DIENTES 4 EN 1



DESPIECE DISPONIBLE

REF.	mm				€
15515	12-13mm x 8-10mm	0.15	10	50	15,50€
15516	14-15mm x 9-11mm	0.20	10	50	19,00€
15517	18-19mm x 16-17mm	0.40	5	50	22,50€

54066

83,00€



SET DE 7 LLAVES CON TRINQUETE EXTRALARGAS



DESPIECE DISPONIBLE

REF.	mm				€	REF.	mm				€
13453	8	0.10	6	36	9,00€	13457	14	0.25	6	36	12,00€
13454	10	0.15	10	100	9,50€	13460	17	0.40	6	24	15,00€
13455	12	0.20	6	36	10,50€	13462	19	0.50	6	24	17,00€
13456	13	0.20	6	36	11,50€						

54032

84,00€

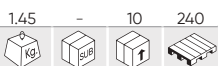

SET DE 12 LLAVES MINI COMBINADAS ARTICULADAS CON TRINQUETE

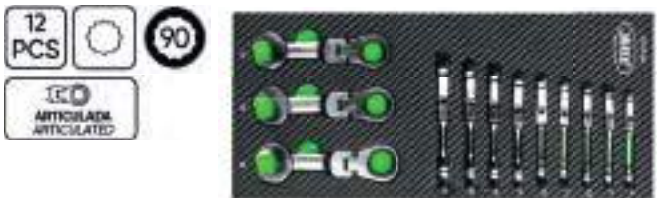

DESPIECE DISPONIBLE

REF.	mm				€	REF.	mm				€
15328	8	0.05	12	96	6,00€	15334	14	0.11	12	96	7,00€
15329	9	0.05	12	96	5,50€	15335	15	0.13	12	96	7,50€
15330	10	0.05	12	96	5,50€	15336	16	0.14	12	96	8,00€
15331	11	0.07	12	96	5,50€	15337	17	0.16	12	96	8,50€
15332	12	0.09	12	96	6,00€	15338	18	0.18	12	96	9,00€
15333	13	0.10	12	96	6,50€	15339	19	0.20	12	96	9,50€

15122

74,00€



MÓDULO EVA CARBONO DE 12 LLAVES COMBINADAS CON TRINQUETE



DESPIECE DISPONIBLE

REF.	mm				€	REF.	mm				€
13465	8	0.05	10	100	5,55€	13471	14	0.11	10	100	6,90€
13466	9	0.06	10	100	5,55€	13472	15	0.13	10	100	7,25€
13467	10	0.10	10	100	6,00€	13473	16	0.15	10	100	8,10€
13468	11	0.08	10	100	6,25€	13474	17	0.19	10	100	8,70€
13469	12	0.09	10	100	6,25€	13475	18	0.22	10	100	9,10€
13470	13	0.10	10	100	6,60€	13476	19	0.22	10	100	9,60€

53018

119,00€



SET DE 6 LLAVES ARTICULADAS CON TRINQUETE



DESPIECE DISPONIBLE

REF.	mm				€
13447	8x9	0.10	6	36	16,50€
13448	10x11	0.15	6	36	17,50€
13449	12x13	0.25	6	36	20,00€

REF.	mm				€
13450	14x15	0.30	6	36	23,00€
13451	16x18	0.35	6	24	28,00€
13452	17x19	0.40	6	24	29,50€



54110

46,00€



SET DE 8 LLAVES COMBINADAS CORTAS CON TRINQUETE



DESPIECE DISPONIBLE

REF.	mm				€
13491	10	0.05	10	100	5,30€
13492	11	0.06	10	100	5,35€
13493	12	0.07	10	100	5,50€
13494	13	0.08	5	100	6,00€

REF.	mm				€
13495	14	0.09	10	100	6,40€
13496	15	0.12	10	100	6,60€
13497	17	0.14	10	100	7,50€
13498	19	0.19	10	100	8,50€



54041

198,00€



SET DE 22 LLAVES COMBINADAS CON TRINQUETE



DESPIECE DISPONIBLE

REF.	mm				€
13463	6	0.03	10	100	5,30€
13464	7	0.04	10	100	5,30€
13465	8	0.05	10	100	5,55€
13466	9	0.06	10	100	5,55€
13467	10	0.10	10	100	6,00€
13468	11	0.08	10	100	6,25€
13469	12	0.09	10	100	6,25€
13470	13	0.10	10	100	6,60€
13471	14	0.11	10	100	6,90€
13472	15	0.13	10	100	7,25€
13473	16	0.15	10	100	8,10€

REF.	mm				€
13474	17	0.19	10	100	8,70€
13475	18	0.22	10	100	9,10€
13476	19	0.22	10	100	9,60€
13477	20	0.23	6	60	9,85€
13478	21	0.37	6	60	12,20€
13479	22	0.37	6	60	13,10€
13480	23	0.37	6	48	15,50€
13481	24	0.53	6	48	15,80€
13482	27	0.60	6	24	22,10€
13483	30	0.80	6	24	25,50€
13484	32	1.12	6	24	27,20€



54079

83,00€

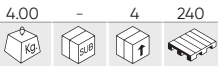

SET DE 21 LLAVES COMBINADAS

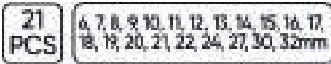

DESPIECE DISPONIBLE

REF.	mm				€
10531	10	0.05	10	100	3,00€
10532	11	0.06	10	100	2,70€
10533	12	0.07	10	100	3,00€
10534	13	0.08	10	100	3,25€
10535	14	0.10	10	100	3,50€
10536	15	0.10	10	100	3,65€
10537	16	0.11	10	100	3,90€
10538	17	0.14	10	100	4,30€
10539	18	0.16	10	100	4,75€

REF.	mm				€
10540	19	0.20	10	100	5,25€
10541	20	0.21	6	60	5,55€
10542	21	0.25	-	50	5,85€
10543	22	0.25	-	50	7,00€
10544	24	0.33	10	100	8,10€
10545	27	0.41	10	50	9,75€
10546	30	0.52	-	25	11,60€
10547	32	0.59	-	25	13,50€
10548	6	0.03	10	100	1,75€



REF.	mm				€
10549	7	0.03	10	100	2,00€
10550	8	0.03	10	100	2,15€
10551	9	0.04	10	100	2,15€

54097

38,90€

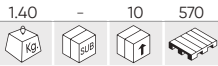

KIT DE 14 LLAVES COMBINADAS



DESPIECE DISPONIBLE

REF.	mm				€
10531	10	0.05	10	100	3,00€
10532	11	0.06	10	100	2,70€
10533	12	0.07	10	100	3,00€
10534	13	0.08	10	100	3,25€
10535	14	0.10	10	100	3,50€
10536	15	0.10	10	100	3,65€
10537	16	0.11	10	100	3,90€

REF.	mm				€
10538	17	0.14	10	100	4,30€
10539	18	0.16	10	100	4,75€
10540	19	0.20	10	100	5,25€
10548	6	0.03	10	100	1,75€
10549	7	0.03	10	100	2,00€
10550	8	0.03	10	100	2,15€
10551	9	0.04	10	100	2,15€



54120

59,00€



KIT DE 7 LLAVES COMBINADAS



DESPIECE DISPONIBLE

REF.	mm				€
10541	20	0.21	6	60	5,55€
10542	21	0.25	-	50	5,85€
10543	22	0.25	-	50	7,00€
10544	24	0.33	10	100	8,10€

REF.	mm				€
10545	27	0.41	10	50	9,75€
10546	30	0.52	-	25	11,60€
10547	32	0.59	-	25	13,50€

54174

139,00€



SET DE 6 LLAVES COMBINADAS



DESPIECE DISPONIBLE

REF.	mm				€
16020	34	0.36	10	100	17,00€
16021	36	0.00	10	100	19,50€
16022	38	0.43	10	100	23,00€

REF.	mm				€
16023	41	0.47	10	100	26,50€
16024	46	0.51	10	100	34,50€
16025	50	0.58	10	100	37,50€

50564

30,00€

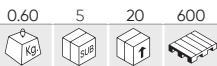

KIT DE 8 LLAVES COMBINADAS CORTAS



DESPIECE DISPONIBLE

REF.	mm	Kg	Vol	Unid	€	REF.	mm	Kg	Vol	Unid	€	REF.	mm	Kg	Vol	Unid	€
10564	10	0.05	10	100	2,50€	10567	13	0.05	10	100	3,50€	10570	17	0.10	10	100	4,50€
10565	11	0.05	10	100	3,50€	10568	14	0.05	10	100	4,00€	10571	19	0.15	10	100	5,00€
10566	12	0.05	10	100	3,50€	10569	15	0.05	10	100	4,50€						



54150

23,50€

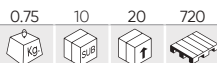

KIT DE 7 LLAVES FIJAS

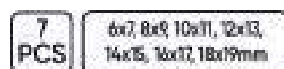

DESPIECE DISPONIBLE

REF.	mm	Kg	Vol	Unid	€	REF.	mm	Kg	Vol	Unid	€
10579	10x11	0.06	10	100	3,00€	10583	18x19	0.19	10	100	4,15€
10580	12x13	0.07	10	100	3,10€	10589	6x7	0.03	10	100	2,00€
10581	14x15	0.10	10	100	3,40€	10590	8x9	0.04	10	100	2,40€
10582	16x17	0.14	10	100	4,00€						

54149

60,00€



KIT DE 12 LLAVES FIJAS



DESPIECE DISPONIBLE

REF.	mm	Kg	Vol	Unid	€	REF.	mm	Kg	Vol	Unid	€
10579	10x11	0.06	10	100	3,00€	10585	21x23	0.31	-	50	6,75€
10580	12x13	0.07	10	100	3,10€	10586	24x27	0.35	10	100	7,60€
10581	14x15	0.10	10	100	3,40€	10587	25x28	0.36	-	50	9,80€
10582	16x17	0.14	10	100	4,00€	10588	30x32	0.54	-	25	10,50€
10583	18x19	0.19	10	100	4,15€	10589	6x7	0.03	10	100	2,00€
10584	20x22	0.25	6	60	5,05€	10590	8x9	0.04	10	100	2,40€

52973

59,00€



KIT DE 12 LLAVES FIJAS - ACABADO BRILLANTE

DESPIECE DISPONIBLE

REF.	mm	Kg	Vol	Unid	€	REF.	mm	Kg	Vol	Unid	€
10579	10x11	0.06	10	100	3,00€	10585	21x23	0.31	-	50	6,75€
10580	12x13	0.07	10	100	3,10€	10586	24x27	0.35	10	100	7,60€
10581	14x15	0.10	10	100	3,40€	10587	25x28	0.36	-	50	9,80€
10582	16x17	0.14	10	100	4,00€	10588	30x32	0.54	-	25	10,50€
10583	18x19	0.19	10	100	4,15€	10589	6x7	0.03	10	100	2,00€
10584	20x22	0.25	6	60	5,05€	10590	8x9	0.04	10	100	2,40€



6x7, 8x9, 10x11, 12x13, 14x15, 16x17, 18x19, 20x22, 21x23, 24x27, 25x28, 30x32mm



54115 26,80€

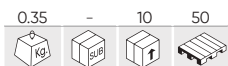

JUEGO DE 4 LLAVES TORX PLANAS

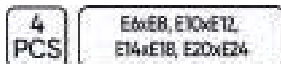

DESPIECE DISPONIBLE

REF.	mm				€
16546	E6xE8	0.05	10	100	5,00€
16547	E10xE12	0.07	10	100	5,50€
16548	E14xE18	0.08	10	100	9,00€
16549	E20xE24	0.09	10	100	14,00€

54081 28,00€

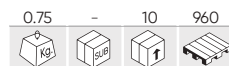

KIT LLAVE HEXAGONAL CON BOCA ABIERTA DE 6 CANTOS

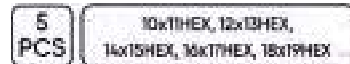

DESPIECE DISPONIBLE

REF.	mm				€
11258	10x11	0.10	5	100	7,30€
11259	12x13	0.10	5	100	8,30€
11260	14x15	0.11	5	100	9,75€
11261	16x17	0.18	5	100	11,35€
11262	18x19	0.21	-	100	13,50€

54159 47,00€



SET 8 LLAVES TIPO "C" CABEZAL REDONDO 12 CANTOS



DESPIECE DISPONIBLE

REF.	mm				€
11639	6x7	0.61	5	50	4,00€
11640	8x9	0.04	5	50	4,50€
11641	10x11	0.04	5	50	5,00€
11642	12x13	0.06	5	50	5,00€

REF.	mm				€
11643	14x15	0.09	5	-	6,00€
11644	16x17	0.12	5	50	7,00€
11645	18x19	0.15	5	50	7,00€
11646	20x22	0.22	5	-	9,45€

52451 42,00€



SET 8 LLAVES TIPO "C" CABEZAL REDONDO 12 CANTOS



DESPIECE DISPONIBLE

REF.	mm				€
11639	6x7	0.61	5	50	4,00€
11640	8x9	0.04	5	50	4,50€
11641	10x11	0.04	5	50	5,00€
11642	12x13	0.06	5	50	5,00€

REF.	mm				€
11643	14x15	0.09	5	-	6,00€
11644	16x17	0.12	5	50	7,00€
11645	18x19	0.15	5	50	7,00€
11646	20x22	0.22	5	-	9,45€

15156 70,00€



MÓDULO EVA FIBRA DE CARBONO DE 4 LLAVES ACODADAS

DESPIECE DISPONIBLE

REF.	mm				€
15206	21x23	0.45	5	50	15,00€
15207	24x27	0.50	5	50	16,50€
15208	25x28	0.45	5	50	17,00€
15209	30x32	0.67	10	50	18,00€

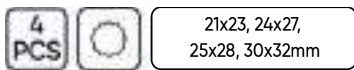

HERRAMIENTAS MANUALES

54119

78,00€



KIT DE 12 LLAVES DE ESTRELLA ACODADAS 12 CANTOS

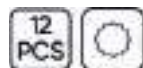

6x7, 8x9, 10x11, 12x13, 14x15, 16x17, 18x19, 20x22, 21x23, 24x27, 25x28, 30x32mm



DESPIECE DISPONIBLE

REF.	mm				€
10627	6x7	0.04	10	100	2,80€
10628	8x9	0.06	10	100	3,10€
10629	10x11	0.08	10	100	3,65€
10630	12x13	0.11	10	100	3,90€
10631	14x15	0.14	10	100	4,20€
10632	16x17	0.18	10	100	5,30€
REF.	mm				€
10633	18x19	0.22	10	100	6,60€
10634	20x22	0.43	-	50	7,80€
10635	21x23	0.30	-	50	8,15€
10636	24x27	0.35	-	25	8,80€
10637	25x28	0.48	6	24	12,10€
10638	30x32	0.73	6	24	12,70€

50562

23,50€



SET DE 7 LLAVES ACODADAS DE 2 BOCAS ESTRELLA

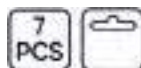

6x7, 8x9, 10x11, 12x13, 14x15, 16x17, 18x19mm



DESPIECE DISPONIBLE

REF.	mm				€
10627	6x7	0.04	10	100	2,80€
10628	8x9	0.06	10	100	3,10€
10629	10x11	0.08	10	100	3,65€
10630	12x13	0.11	10	100	3,90€
REF.	mm				€
10631	14x15	0.14	10	100	4,20€
10632	16x17	0.18	10	100	5,30€
10633	18x19	0.22	10	100	6,60€

51528

49,00€



KIT 14 LLAVES PIPA DE DOBLE BOCA



8, 9, 10, 11, 12, 13, 14, 15, 16, 17, 18, 19, 20, 21mm



DESPIECE DISPONIBLE

REF.	mm				€
10591	10	0.09	10	200	2,50€
10592	11	0.12	10	200	2,55€
10593	12	0.16	10	120	3,15€
10594	13	0.17	10	100	3,20€
10595	14	0.20	10	100	3,35€
10596	15	0.25	10	70	4,25€
10597	16	0.30	10	70	4,50€
REF.	mm				€
10598	17	0.32	10	60	4,60€
10599	18	0.43	10	40	6,00€
10600	19	0.41	10	40	6,25€
10601	20	0.45	10	30	6,50€
10602	21	0.47	10	30	7,05€
10603	8	0.07	10	300	2,10€
10604	9	0.08	10	200	2,25€

53420

72,00€



SET DE 8 LLAVES DE TUBO

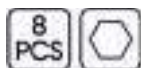

6x7, 8x9, 10x11, 12x13, 14x15, 16x17, 18x19, 20x22mm



53979 34,60€

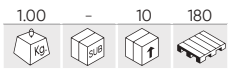

SET DE 8 LLAVES TORX EN FORMA DE "T"



8 PCS
T10x75, T15x75, T20x100, T25x100, T30x150, T40x150, T45x200, T50x200mm

53980 34,60€

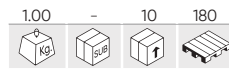

SET DE 8 LLAVES ALLEN EN FORMA DE "T"

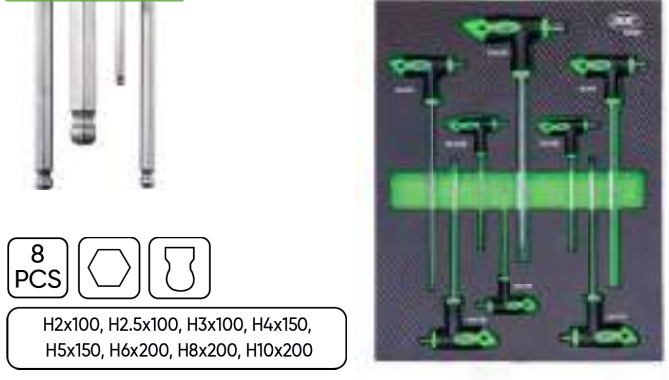

8 PCS
H2x100, H2.5x100, H3x100, H4x150, H5x150, H6x200, H8x200, H10x200

MÓDULO EVA DE 6 LLAVES EXTRALARGAS

51864 64,00€

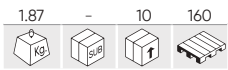

10x11mm (290mmL), 12x14mm (330mmL), 13x15mm (368mmL), 16x18mm (407mmL), 17x19mm (407mmL), 22x24mm (430mmL)



52912 91,00€



E6xE7 (200mmL), E8xE10 (235mmL), E11xE12 (290mmL), E14xE16 (370mmL), E18xE20 (410mmL), E22xE24 (420mmL)



DESPIECE DISPONIBLE

REF.	mm	Kg	L	mm	€	REF.	mm	Kg	L	mm	€
11244	10x11	0.13	5	100	8,50€	11247	16x18	0.30	6	36	14,00€
11245	12x14	0.18	10	50	9,15€	11248	17x19	0.31	10	36	14,60€
11246	13x15	0.25	6	36	12,40€	11249	22x24	0.43	5	-	26,50€

SET DE 9 LLAVES

TORX

REF.	mm	DESCRIPCIÓN	Kg	L	mm	€
53737	90-218mm	SET DE 9 LLAVES TORX EXTRALARGAS	0.42	10	40 1000	12,50€
53739	86-150mm	SET DE 9 LLAVES TORX LARGAS	0.32	10	40 960	10,50€
53955	72-170mm	SET DE 9 LLAVES TORX CORTAS	0.25	10	40 1480	10,00€



T10, T15, T20, T25, T27, T30, T40, T45, T50

ALLEN

REF.	mm	DESCRIPCIÓN	Kg	L	mm	€
53738	90-220mm	SET DE 9 LLAVES ALLEN CON PUNTA REDONDA EXTRALARGAS	0.45	10	40 1000	10,90€
53740	72-170mm	SET DE 9 LLAVES ALLEN LARGAS CON PUNTA REDONDA	0.37	10	40 960	9,10€
53954	43-97mm	SET DE 9 LLAVES ALLEN CORTAS CON PUNTA REDONDA	0.25	10	40 1480	8,50€



1,5, 2, 2,5, 3, 4, 5, 6, 8, 10mm



HERRAMIENTAS MANUALES

51659

59,00€

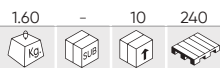

ESTUCHE CON 6 LLAVES DE VASO DE 12 CANTOS ARTICULADAS

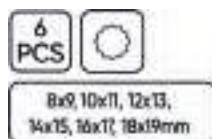

DESPIECE DISPONIBLE

REF.	mm				€
10621	8-9	0.09	10	100	9,50€
10622	10-11	0.13	10	100	10,00€
10623	12-13	0.16	5	100	12,60€

50622

64,00€

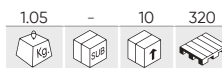

ESTUCHE CON 4 LLAVES DE VASO ARTICULADAS TORX



DESPIECE DISPONIBLE

REF.	mm				€
10617	E6x E8	0.07	10	100	14,10€
10618	E10x E12	0.11	10	100	15,10€
10619	E14x E18	0.20	10	100	15,70€
10620	E20x E24	0.34	10	100	16,20€

54187

39,30€



SET DE 10 LLAVES CROWFOOT DE 3/8"

DESPIECE DISPONIBLE

REF.	mm				€
16010	10	0.04	10	100	4,00€
16011	11	0.04	10	100	4,00€
16012	13	0.04	10	100	4,00€
16013	14	0.05	10	100	4,50€
16014	15	0.05	10	100	4,50€

REF.	mm				€
16015	16	0.05	10	100	5,00€
16016	17	0.05	10	100	5,00€
16017	18	0.06	10	100	5,00€
16018	19	0.06	10	100	5,50€
16019	22	0.08	10	100	6,00€

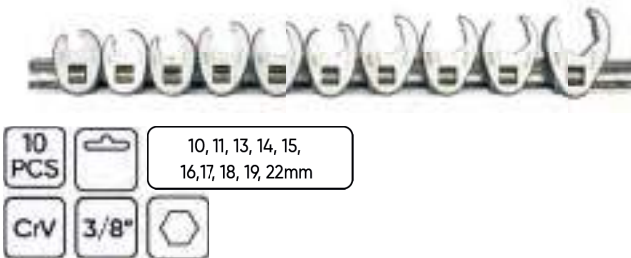

HERRAMIENTAS EN PULGADA

51890

92,00€



SET DE 17 LLAVES COMBINADAS EN PULGADA

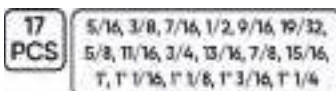

54005

14,00€



SET DE 9 LLAVES ALLEN EN PULGADA CON PUNTA REDONDA

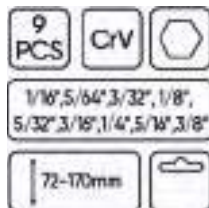

54106

89,00€



MALETÍN DE HERRAMIENTAS DE 37 PIEZAS EN PULGADA CINCO

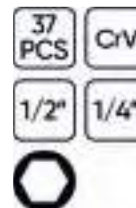

LLAVE EN CRUZ UNIÓN SOLDADA

<p>51661 12,00€</p> <p>1.17 5 20 360</p> <p>1/2" 355mm</p> <p>17, 19, 21mm</p>	<p>52880 42,00€</p> <p>3.75 - 5 120</p> <p>3/4" 700mm</p> <p>24, 27, 32mm</p>	<p>52881 17,00€</p> <p>1.40 - 10 480</p> <p>1/2" 400mm</p> <p>17, 19, 21, 22mm</p>
---	--	---

51416 12,00€

1.05 10 20 360

LLAVE EXTENSIBLE DE RUEDA CON VASOS REVERSIBLES 330-490MM

1/2"

17/19mm
21/23mm

LLAVE INGLESA

MODELO 1

REF.	DESCRIPCIÓN		mm					€
51798	LLAVE INGLESA DE 18"	53mm	450mm	1.90	3	12	480	39,60€
52424	LLAVE INGLESA DE 24"	62mm	610mm	3.75	-	5	350	64,00€



MODELO 2

REF.	DESCRIPCIÓN		mm					€
51795	LLAVE INGLESA DE 8"	22mm	200mm	0.28	6	60	3600	9,00€
51796	LLAVE INGLESA DE 10"	28mm	250mm	0.48	6	36	2400	14,00€
51797	LLAVE INGLESA DE 12"	37mm	300mm	0.71	6	24	960	18,00€



MODELO 3

REF.	DESCRIPCIÓN		mm					€
53639	LLAVE INGLESA DE 6"	28mm	150mm	0.15	6	96	576	28,60€
53640	LLAVE INGLESA DE 8"	30mm	200mm	0.28	6	72	504	34,40€
53641	LLAVE INGLESA DE 10"	33mm	250mm	0.50	6	36	1151	41,00€
53642	LLAVE INGLESA DE 12"	40mm	300mm	0.83	6	10	1200	54,00€
53643	LLAVE INGLESA DE 16"	52mm	400mm	1.53	-	12	336	92,00€
54098	LLAVE INGLESA DE 20"	65mm	640mm	2.70	-	6	-	158,50€



53654 81,00€

1.40 - 5 200





SET DE LLAVES DE GANCHO

8 PCS 35-60, 60-90, 90-120mm

160mm 177mm 250mm





HERRAMIENTAS MANUALES

LLAVE STILLSON

REF.	DESCRIPCIÓN		"					€
52235	LLAVE STILLSON 300MM	50mm	12"	0.90	6	24	1140	11,00€
52236	LLAVE STILLSON 350MM	60mm	14"	1.09	6	24	760	13,30€
52237	LLAVE STILLSON 450MM	70mm	18"	1.75	4	12	720	18,10€
52238	LLAVE STILLSON 600MM	75mm	24"	2.50	2	8	600	24,90€
53210	LLAVE STILLSON 915MM	110mm	36"	4.95	-	4	96	48,00€







LLAVE STILLSON ALUMINIO

REF.	DESCRIPCIÓN		mm					€
53070	LLAVE STILLSON ALUMINIO 12"	45mm	270mm	0.68	6	24	900	16,20€
53071	LLAVE STILLSON ALUMINIO 14"	50mm	320mm	0.92	4	12	900	26,10€
53072	LLAVE STILLSON ALUMINIO 18"	65mm	410mm	1.35	4	12	900	31,60€
53073	LLAVE STILLSON ALUMINIO 24"	75mm	540mm	2.05	2	8	1000	50,00€



SARGENTOS

REF.	DESCRIPCIÓN					€
52349	SARGENTO DE SUJECIÓN 90X200MM	1.25	-	10	480	22,10€
52350	SARGENTO DE SUJECIÓN 90X300MM	1.41	-	10	540	22,60€
52351	SARGENTO DE SUJECIÓN 90X400MM	1.60	-	10	480	25,40€
52352	SARGENTO DE SUJECIÓN 120X300MM	1.99	-	10	360	32,40€
52353	SARGENTO DE SUJECIÓN 120X400MM	2.10	-	10	350	33,40€
52354	SARGENTO DE SUJECIÓN 120X500MM	2.41	-	6	300	34,40€
52355	SARGENTO DE SUJECIÓN 120X600MM	2.62	-	4	300	36,60€
52357	SARGENTO DE SUJECIÓN 150X800MM	4.60	-	5	125	54,00€
52358	SARGENTO DE SUJECIÓN 150X1000MM	5.35	-	5	120	63,00€



CARRACA 72 DIENTES CON VASOS

REF.	DESCRIPCIÓN					€
54028	CARRACA DE 72 DIENTES CON VASOS HEXAGONALES 1/2"	1.30	4	24	432	28,00€
54029	CARRACA DE 72 DIENTES CON VASOS DE 12 CANTOS 1/2"	1.25	4	24	432	28,00€
54030	CARRACA DE 72 DIENTES CON VASOS HEXAGONALES 1/4"	0.35	6	36	1008	18,80€
54031	CARRACA DE 72 DIENTES CON VASOS DE 12 CANTOS 1/4"	0.35	6	36	864	19,30€



54028 - 54029	10, 11, 12, 13, 14, 15, 16, 17, 18, 19mm
54030 - 54031	4, 5, 6, 7, 8, 9, 10, 11, 12, 13mm

CARRACA 72 DIENTES

CROMADA

REF.	DESCRIPCIÓN					€
54022	CARRACA DE 72 DIENTES 1/4" 145MM CROMADA	0.15	12	36	1440	9,95€
54023	CARRACA DE 72 DIENTES 3/8" 200MM CROMADA	0.30	12	24	1440	13,50€
54024	CARRACA DE 72 DIENTES 1/2" 255MM CROMADA	0.60	12	24	960	17,90€



EN EXPOSITOR DE 12 UNIDADES



CINCADA

REF.	DESCRIPCIÓN					€
54018	CARRACA DE 72 DIENTES 1/4" 145MM CINCADA	0.15	12	36	1440	9,85€
54019	CARRACA DE 72 DIENTES 1/2" 255MM CINCADA	0.60	12	24	864	17,90€
54021	CARRACA DE 72 DIENTES 3/8" 200MM CINCADA	0.60	12	24	1440	13,50€



EN EXPOSITOR DE 12 UNIDADES



CARRACA RECTA DE 72 DIENTES

REF.	DESCRIPCIÓN					€
54083	CARRACA RECTA DE 72 DIENTES 1/4"	0.14	12	24	2592	9,75€
54084	CARRACA RECTA DE 72 DIENTES 3/8"	0.30	12	24	1440	13,10€
54085	CARRACA RECTA DE 72 DIENTES 1/2"	0.60	12	24	960	17,80€



EN EXPOSITOR DE 12 UNIDADES



CARRACA RECTA COMPACTA DE 72 DIENTES

REF.	DESCRIPCIÓN					€
54086	CARRACA RECTA COMPACTA DE 72 DIENTES 1/4"	0.10	12	24	2592	9,25€
54087	CARRACA RECTA COMPACTA DE 72 DIENTES 1/2"	0.50	12	24	1008	17,30€



EN EXPOSITOR DE 12 UNIDADES



HERRAMIENTAS MANUALES

52197

36,30€



CARRACA ARTICULADA EXTENSIBLE DE 1/2" 72 DIENTES

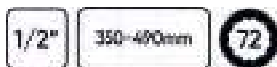

EN EXPOSITOR DE 6 UNIDADES

52207

24,20€



CARRACA MINI DE 72 DIENTES CINCADA 1/4" 85MM



EN EXPOSITOR DE 12 UNIDADES

CARRACA DE 72 DIENTES ARTICULADA

REF.						€
52587	1/4" 172mm	0.16	12	144	3456	39,90€
52588	1/2" 172mm	0.17	12	144	3456	45,00€



EN EXPOSITOR DE 12 UNIDADES



CARRACA DE 72 DIENTES ARTICULADA

REF.						€
51305	1/2" 175mm	0.31	12	48	816	28,90€
51306	1/4" 165mm	0.30	12	48	816	28,10€



EN EXPOSITOR DE 12 UNIDADES



CARRACA DE 72 DIENTES DE CABEZAL GIRATORIO

REF.						€
51405	1/4" 145mm	0.58	12	24	-	21,10€
51406	1/2" 280mm	0.66	12	24	864	29,20€



EN EXPOSITOR DE 12 UNIDADES



CARRACA EXTENSIBLE 72 DIENTES

REF.							€
51307	1/2" 305-445mm	0.92	6	12	360	-	29,70€
53346	1/4" 150-200mm	0.25	6	12	-	-	18,00€
54304	1/2" 450-610mm	1.15	-	6	480	-	26,00€



EN EXPOSITOR DE 6 UNIDADES



CARRACA ARTICULADA EXTRA LARGA DE 72 DIENTES

REF.	DESCRIPCIÓN						€
53886	1/4" 305mm	0.27	10	40	1680	-	20,30€
53887	3/8" 457mm	0.68	10	20	700	-	30,30€
53888	1/2" 609mm	1.27	4	16	480	-	37,90€



PUNTA DE RECAMBIO

REF.	"						€
15147	3/8"	0.10	-	100	-	-	5,00€

REF.	"						€
15148	1/2"	0.20	-	100	-	-	5,00€

REF.	"						€
15149	1/4"	0.05	-	100	-	-	5,00€



51801 62,00€



CARRACA FLEXIBLE DE 72 DIENTES DE 3/8" 500MM



MUY ÚTIL EN LUGARES DE DIFÍCIL ACCESO

SE ACCIONA ROTANDO EL MANGO

CON CABEZAL GIRATORIO



53671 41,00€

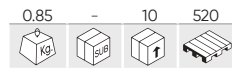

SET DE 3 CARRACAS MINI

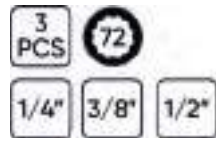

SET DE REPARACIÓN CARRACA MINI

REF.	DESCRIPCIÓN					€
15138	1/4"	0.10	-	50	-	10,50€
15139	3/8"	0.15	-	50	-	12,00€
15140	1/2"	0.20	-	50	-	13,50€

54339 273,00€

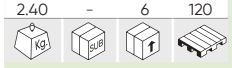

LLAVE DINAMOMÉTRICA DIGITAL DE 1/2" 10-200NM



N

52913 292,00€

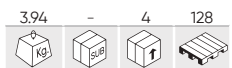

LLAVE DINAMOMÉTRICA CON CABEZAL INTERCAMBIABLE 200NM

1/2"

	x1	1/2"
	x9	13, 14, 15, 17, 19, 22, 24, 27, 30mm
	x1	40-200Nm

- Incluyen certificado de calibración de fábrica.



54269 56,00€



ESTUCHE DE HERRAMIENTAS DE 21 PIEZAS CON LLAVE DINAMOMÉTRICA DE 1/4"

1/4" N

	x1	5-25Nm		x3	PH1, PH2, PH3
	x1	100mm		x8	H2, H2.5, H3, H4, H5, H6, H8, H10 (37mmL)
	x1	UNIVERSAL		x1	H5 (87mmL)
	x1	1/4" (F) - 3/8" (M)		x5	T10, T15, T20, T25, T30



53972

550,00€

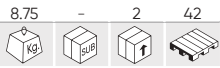

LLAVE DINAMOMÉTRICA DE 3/4"

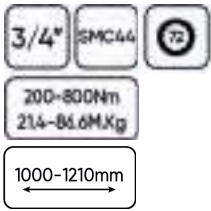

- Incluyen certificado de calibración de fábrica.

LLAVE DINAMOMÉTRICA CON MIRILLA

REF.	DESCRIPCIÓN	Icon 1	Icon 2	Icon 3	Icon 4	€
53081	1/4" 4-20NM (36T) 375mm	1.10	5	25	350	115,00€
53082	1/2" 40-210NM (24T) 560mm	1.90	4	8	168	148,00€

- Incluyen certificado de calibración de fábrica.



LLAVES DINAMOMÉTRICAS

REF.	DESCRIPCIÓN	Icon 1	Icon 2	Icon 3	Icon 4	€
51127	1/2" 28-210NM 470mm	1.70	4	8	256	56,00€
51262	1/4" 5-25NM 270mm	0.80	4	16	384	51,00€
51338	3/8" 19-110NM 365mm	1.05	4	16	384	53,00€



SETS DE REPARACIÓN

REF.	"	Icon 1	Icon 2	Icon 3	Icon 4	€	REF.	"	Icon 1	Icon 2	Icon 3	Icon 4	€	REF.	"	Icon 1	Icon 2	Icon 3	Icon 4	€
51127R	1/2"	0.15	-	20	-	14,00€	51262R	1/4"	0.05	-	20	-	14,00€	51338R	3/8"	0.05	-	20	-	14,00€



51830

94,00€

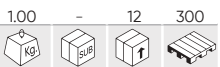

DESTORNILLADOR DINAMOMÉTRICO MECÁNICO

- Exactitud: CW: +/- 4%
- Rango de operación: 2-10 N-m
- Unidades de selección: N-m, in-lb.
- Largo (mm): 242
- Dado: 1/4"
- Vida útil: 2000 ciclos

- Incluyen certificado de calibración de fábrica.



ADAPTADOR CON CORREDERA

REF.	DESCRIPCIÓN	Icon 1	Icon 2	Icon 3	Icon 4	€
53468	1/2" 250mm	0.35	6	48	600	8,50€
53478	1/4" 115mm	0.50	5	100	1200	4,55€
53479	3/8" 200mm	0.15	5	50	300	6,40€
53480	3/4" 460mm	1.35	5	10	440	19,90€
53481	1" 550mm	2.85	-	5	300	27,40€



MANERALES CON CABEZAL ARTICULADO

REF.	DESCRIPCIÓN					€
52524	3/4" 1020mm	3.60	3	6	144	51,00€
52526	1/2" 600mm	1.65	5	10	600	28,40€
52525	1/2" 430mm	0.85	10	20	1500	13,80€



PUNTA DE RECAMBIO

REF.	"					€
11945	1/2"	0.15	25	100	-	7,00€

PARA 52526

REF.	"					€
11946	1/2"	0.06	25	300	-	4,50€

PARA 52525

REF.	"					€
11947	3/4"	0.51	10	40	960	19,00€

PARA 52524



54343

31,00€

1.15	-	6	594
------	---	---	-----



MANERAL EXTENSIBLE 1/2" 450-600MM



51479

31,80€

0.65	12	24	1056
------	----	----	------



BARRA EXTENSIBLE DE 1/2" CON CABOTA REDONDA



EN EXPOSITOR DE 12 UNIDADES

51805

17,00€

0.33	4	20	640
------	---	----	-----

SET DE BARRAS DE EXTENSIÓN DE 1/4" CON CABOTA REDONDA

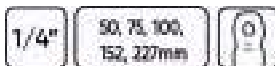

51447

16,00€

0.34	5	20	960
------	---	----	-----

SET DE BARRAS DE EXTENSIÓN DE 1/4" CON CABOTA NORMAL



51448

52,00€

2.38	-	5	300
------	---	---	-----

SET DE BARRAS DE EXTENSIÓN DE 1/2" CON CABOTA REDONDA



DESPIECE DISPONIBLE

REF.	mm				€
12995	50	0.03	5	100	7,00€
12996	75	0.04	20	100	7,00€
12997	100	0.06	20	100	7,50€
12998	152	0.08	5	100	9,00€
12999	227	0.11	5	100	9,50€

DESPIECE DISPONIBLE

REF.	mm				€
14026	50	0.03	10	100	5,50€
14027	75	0.04	-	50	5,60€
10264	100	0.05	10	100	2,00€
14029	152	0.07	-	50	8,50€
14030	227	0.11	-	50	9,50€

DESPIECE DISPONIBLE

REF.	mm				€
14978	50	0.10	5	100	7,50€
14979	125	0.20	5	50	9,00€
14980	250	0.40	5	25	13,00€
14981	380	0.60	5	20	22,50€
14982	510	0.60	5	10	27,50€

54302

11,50€

0.45	10	40	650
------	----	----	-----

SET DE 6 DESTORNILLADORES DE PRECISIÓN



HERRAMIENTAS MANUALES

52500

19,00€



SET DE 8 DESTORNILLADORES CORTOS

8 PCS



CONTIENE

- ⊕ x3 PH00x25, PH0x25, PH1x25
- ⊖ x5 SL0.4x2x25, SL0.4x2.5x25, SL0.5x3x.25, SL0.5x3.5x25, SL0.8x4x25

53917

9,00€

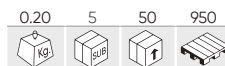

SET DE 7 DESTORNILLADORES LARGOS

7 PCS



CONTIENE

- ⊕ x3 PH00, PH0, PH1
- ⊖ x4 SL.1.4, SL2.0, SL.2.4, SL3.0

53694

18,40€



DESTORNILLADOR DE GOLPEO 1/2"

8 PCS 1/2"



CONTIENE

- ⊕ x1 1/2"
- ⊖ x1 1/2" - 8mm
- ⊕ x3 PH 2x36mm, 3x36mm, 3x70mm
- ⊖ x3 SL 7x36mm, 8x36mm, 8x70mm

54126

39,00€



JUEGO DE DESTORNILLADORES DE GOLPEO PUNTA IMANTADA

12 PCS



CONTIENE

- ⊕ x6 PH0x75mm, PH1x75mm, PH2x38mm, PH2x100mm, PH3x125mm, PH4x200mm
- ⊖ x6 SL3.2x75mm, SL5x75mm, SL6x38mm, SL6x100mm, SL8x150mm, SL9.5x200mm

53010

18,00€

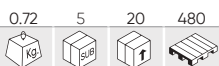

ESTUCHE DE DESTORNILLADORES CON MANGO INTERCAMBIABLE 20 EN 1

11 PCS



CONTIENE

- ⊕ x2 PH1, PH2
- ⊖ x2 4x6, 5x7mm
- ⊕ x3 T10x15, T20x25, T30x40
- ⊕ x3 H4x4mm, H5x5mm, H6x6mm
- x1

50902

13,00€



JUEGO DE 4 DESTORNILLADORES PLANOS DE GOLPEO

4 PCS 3", 4", 6", 8"



DESTORNILLADORES CON MÓDULO EVA CARBONO

53943

21,50€



- ⊕ PH4x200, PH3x150, PH2x100, PH2x38, PH1x80, PH0x120, PH1x100



53944

19,50€



- ⊖ SL9x200, SL4x125, SL5x100, SL5x80, SL6x38, SL6x100, SL8x150mm



53945

18,90€



- ⊕ T8x75, T9x75, T10x75, T15x75, T20x75, T25x100, T27x100

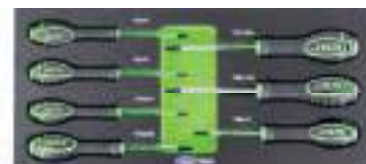

54060 6,00€

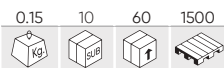

DESTORNILLADOR REVERSIBLE PLANO ESTRELLA 6X150MM

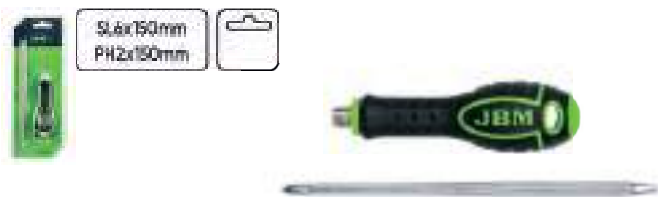

54061 6,00€

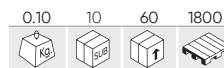

DESTORNILLADOR REVERSIBLE PLANO ESTRELLA 6X100MM

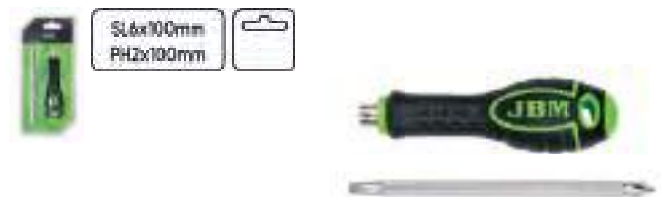

54071 26,50€



SET DE 6 DESTORNILLADORES GO-THROUGH (3 ESTRELLA + 3 PLANOS)



CONTIENE

- ⊕ x3 PH3x150, PH2x100, PH1x75mm
- ⊖ x3 SL8x150, SL6.5x100, SL5.5x75mm

54070 18,00€



SET DE 6 DESTORNILLADORES (2 ESTRELLA + 4 PLANOS)



CONTIENE

- ⊕ x2 PH1x80, PH2x100mm
- ⊖ x4 SL6.5x150, SL5.5x125, SL4x100, SL3x80mm

52170 16,00€



DESTORNILLADOR FLEXIBLE



52169 25,00€



JUEGO DE 3 DESTORNILLADORES FLEXIBLES



53575 16,00€



DESTORNILLADOR FLEXIBLE



- x3 1/4" 4 mm
- 5 mm
- 7 mm

HERRAMIENTAS MANUALES

53225

3,50€

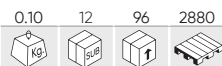

MAGNETIZADOR/DESMAGNETIZADOR



51812

46,00€



SET DE 5 ALICATES EN ESTUCHE



CONTIENE

A	x1	160mm
B	x1	160mm
C	x1	180mm
D	x1	200mm
E	x1	250mm

ALICATES SEEGER BOCA RECTA

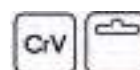

PARA INTERIORES

REF.	DESCRIPCIÓN					€
51018	7" 180mm	0.14	5	100	1800	7,05€
52964	9" 225mm	0.23	6	60	1440	9,45€
53549	13" 330mm	0.45	5	30	-	14,30€



PARA EXTERIORES

REF.	DESCRIPCIÓN					€
51017	7" 180mm	0.17	5	100	1800	6,80€
52966	9" 225mm	0.28	6	60	1800	9,45€
53547	13" 330mm	0.50	5	30	-	14,70€



ALICATES SEEGER BOCA CURVA

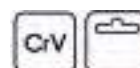

PARA INTERIORES

REF.	DESCRIPCIÓN					€
51021	7" 180mm	0.16	5	100	-	7,05€
52965	9" 225mm	0.24	6	60	1440	9,20€
53550	13" 330mm	0.45	5	30	-	14,70€



PARA EXTERIORES

REF.	DESCRIPCIÓN					€
51020	7" 180mm	0.13	5	100	1600	6,65€
52967	9" 225mm	0.24	6	60	1440	9,40€
53548	13" 330mm	0.50	5	30	-	15,60€



ALICATE CORTE DIAGONAL

REF.	DESCRIPCIÓN					€
53905	6" 160mm	0.20	6	60	1440	7,30€
53906	7" 180mm	0.20	6	60	1560	8,65€



ALICATE PUNTA ALARGADA

REF.	DESCRIPCIÓN					€
53908	6" 160mm	0.15	6	60	1440	7,25€
53909	8" 200mm	0.20	6	60	1440	9,70€



ALICATE UNIVERSAL

REF.	DESCRIPCIÓN						€
53911	6" 160mm	0.20	6	60	1440		8,80€
53967	8" 200mm	0.30	6	60	1440		10,20€
54015	7" 180mm	0.20	6	60	1920		10,20€



15454

35,40€

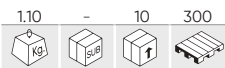

8"

MÓDULO EVA DE ALICATES SEGER 8"



REF.	DESCRIPCIÓN						€
10526	ALICATE SEGER PARA INTERIORES BOCA RECTA 8"	0.21	5	50	-		10,00€
10642	ALICATE SEGER PARA EXTERIORES BOCA RECTA 8"	0.22	5	50	-		10,00€
10643	ALICATE SEGER PARA INTERIORES BOCA CURVA 8"	0.21	5	50	-		10,00€
10644	ALICATE SEGER PARA EXTERIORES BOCA CURVADA 8"	0.22	5	50	-		10,00€

53389

31,50€

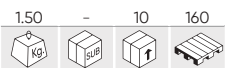

SET DE ALICATES SEEGER CON PUNTA INTERCAMBIABLE



ALICATE DE PICO DE LORO

REF.								€
52052	515mm	140mm	1.88	5	10	400		53,00€
50567	250mm	40mm	0.34	10	60	1500		9,60€



52846

37,80€



ALICATE EXTRALARGA SISTEMA TIJERA RECTA

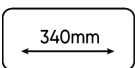

52847

41,00€



ALICATE EXTRALARGA SISTEMA TIJERA CURVADA 45°

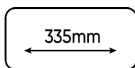

52272

24,60€



SET ALICATES PUNTA DE 0°, 45° Y 90°



HERRAMIENTAS MANUALES

53390

34,50€

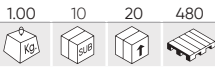

ALICATE PARA ABRAZADERAS



REF.	DESCRIPCIÓN	Kg	SUB	Box	Units	€
14180	SET DE RECAMBIOS PARA REF.53390	0.01	-	100	-	7,90€

51995

24,50€

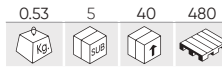

ALICATE PARA ABRAZADERAS



REF.	DESCRIPCIÓN	Kg	SUB	Box	Units	€
14179	SET DE RECAMBIOS PARA REF.51995	0.01	-	100	-	8,50€

53396

18,30€

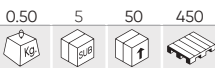

ALICATE PARA ABRAZADERAS DE TUBOS DE ESCAPE

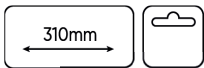

52791

18,00€

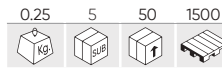

ALICATE ESPECIAL ABRAZADERAS TUBO TIPO CLIC - "R"

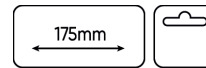

54376

12,00€

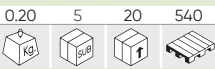

ALICATES PARA ABRAZADERAS DE FUELLE DE PALIER CON CORTADOR

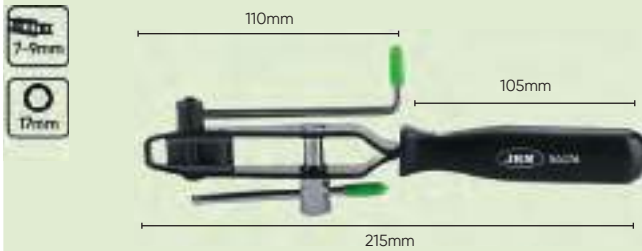

54311

13,00€



ALICATE PARA ABRAZADERA PARA FUELLE DE PALIER



54330

12,50€

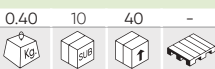

ALICATES PARA RETENES DE VÁLVULA



54279

6,00€

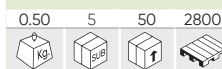

ALICATES PARA EXTRACCIÓN DE BOMBILLAS



54479 36,50€

0.63 5 10 400

N

ALICATES PARA ABRAZADERAS METÁLICAS AUTOBLOCANES

IRON PCV

0,2-0,4 mm 4,5-12 mm

52412 5,00€

0.09 24 144 5760

ALICATE MINI PLEGABLE MULTIUSOS 105MM

CONTIENE

- x2 Destornillador plano
- x1 Punta estrella
- x1 Abrebotellas
- x1 Abrelatas
- x1 Lima 25mm
- x1 Hojas de sierra 40mm
- x1 Hoja de corte 40mm

52050 98,00€

3.24 - 4 60

SET DE ALICATES PARA ABRAZADERAS

DESPIECE DISPONIBLE

REF.	DESCRIPCIÓN	Kg	Sub	U	Paq	€
A	13707 ALICATE PARA ABRAZADERAS ELÁSTICAS CON PUNTA ROTATIVA	0.25	10	40	-	14,00€
B	13708 ALICATE PARA ABRAZADERAS ELÁSTICAS	0.24	6	48	-	14,00€
C	13709 ALICATE PARA ABRAZADERAS ELÁSTICAS CON PUNTA RECTA	0.24	6	48	576	14,00€
D	13710 ALICATE PARA ABRAZADERAS ELÁSTICAS 45°	0.70	6	48	1536	14,00€
E	13712 ALICATE PARA LA EXTRACCIÓN DE TUBOS P/52050	0.21	10	40	-	14,00€
F	51995 ALICATE PARA ABRAZADERAS	0.53	5	40	480	24,50€
G	52791 ALICATE ESPECIAL ABRAZADERAS TUBO TIPO CLIC - "R"	0.25	5	50	1500	18,00€

52619 23,10€

0.55 6 36 648

ALICATE ABRAZADERA PARA FUELLE PALIER

Agujeros de 1/2" en los mangos para usar como llave.
Apertura: 0-20mm

52812 65,00€

0.85 5 20 500

ALICATE ABRAZADERA PARA FUELLE PALIER

Adaptador de 3/8" para apriete con carraca.
Apertura máxima: 34mm

53487 16,70€

0.30 5 40 1280

ALICATE PARA TUBO DE COMBUSTIBLE

Audi / VW, Fiat, GM, Mercedes

52508 38,40€

0.37 10 50 800

ALICATE ABRAZADERA

CrMo 0-20mm

52509 36,20€

0.39 10 50 800

CrMo 0-20mm

PESTAÑA DE BLOQUEO

HERRAMIENTAS MANUALES

52625

9,00€



ALICATES PARA FRENO DE TAMBOR



51355

19,00€



ALICATE ESPECIAL PARA CONTRAPESAS



52982

53,00€

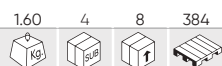

KIT DE 3 ALICATES DE MORDAZA EXTRALARGA



53445

17,10€



JUEGO DE ALICATES PARA DESCONEXIÓN DEL TUBO DE COMBUSTIBLE



- x1 5/16" Ø 8mm
- x1 3/8" Ø 10mm
- x1 APLICACIÓN ESPECIAL



51972

12,00€



HERRAMIENTA PELACABLES AUTOAJUSTABLE



0.25~2.5mm²

08-6mm



52152

13,50€



TIJERAS CORTACABLE

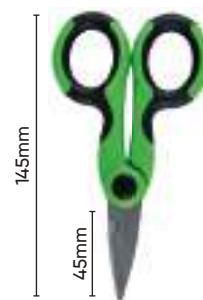
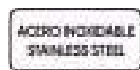

53411

5,00€

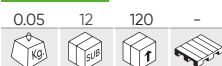

ALICATES PELACABLES MINI



53412

4,00€



ALICATES PELACABLES MINI



ALICATE CORTACABLES

REF.	DESCRIPCIÓN					€
53602	360mm - Ø 125mm ²	0.60	-	5	300	30,50€
53603	550mm - Ø 250mm ²	1.75	-	5	300	45,00€
53604	800mm - Ø 500mm ²	3.70	-	5	120	118,00€



CORTAVARILLAS

REF.	DESCRIPCIÓN					€
52955	12" - 300mm	0.77	-	20	200	19,80€
52956	14" - 350mm	0.95	-	20	200	19,60€
52957	18" - 450mm	1.47	-	10	360	23,80€
52958	24" - 600mm	2.40	-	8	210	28,20€
52959	30" - 750mm	3.78	-	5	100	42,00€
52960	36" - 900mm	5.15	-	5	105	46,00€



53385 19,30€

0.15	6	54	1026
------	---	----	------



ALICATE PARA EXTRACCIÓN DE GRAPAS DE CARROCERÍA



53976 9,00€

0.20	6	60	1440
------	---	----	------



ALICATE DE PUNTA ESPECIAL TERMINALES 6" 160MM

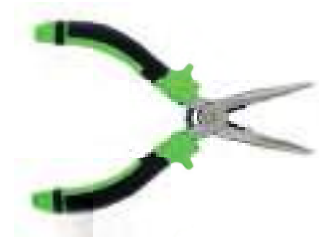

52761 8,00€

0.25	12	72	1800
------	----	----	------



ALICATES PARA TERMINALES AISLADOS Y NO AISLADOS 9"



53932 8,00€

0.25	12	72	1296
------	----	----	------



ALICATES PARA TERMINALES AISLADOS Y NO AISLADOS 9"



52762 9,00€

0.25	12	72	1800
------	----	----	------



ALICATES PARA TERMINALES NO AISLADOS 8-3/4"

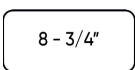

16111 19,20€

0.61	-	10	200
------	---	----	-----



MÓDULO EVA PELACABLES Y TERMINALES



54254

43,00€

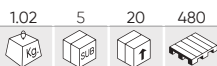

ALICATE PARA TERMINALES CON PUNTA INTERCAMBIABLE

7 PCS

CONTIENE

- Alicates de 9"
- Punta de 0,15-6mm°
- Punta de 10-35mm°
- Punta de 0,5-6mm°
- Punta de 0,5-10mm°
- Punta de 0,5-4mm°
- Destornillador PH2x150



54112

18,00€

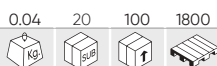

EXTRACTOR DE TERMINALES CON 6 CONECTORES

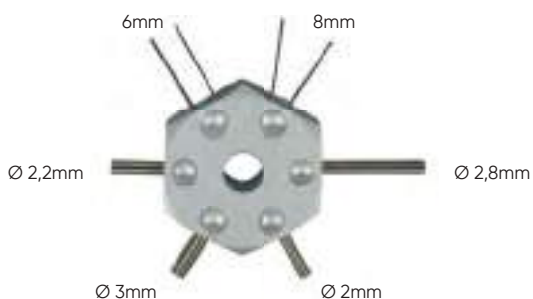

54142

15,20€



SET DE GANCHOS, PUNAS Y PALANCAS ANTIMARCAS (6 PCS)

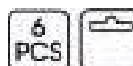

CONTIENE

- 2 puntas en gancho
- 2 puntas rectas
- 2 puntas en ángulo
- 6 puntas con palancas



ALARGADOR FLEXIBLE

REF.	DESCRIPCIÓN	Ø	—					€
51525	ALARGADOR FLEXIBLE CON PUNTA IMANTADA	A	7mm	500mm	0.14	10	60 960	9,80€
51526	ALARGADOR FLEXIBLE CON PUNTA DE 4 GARRAS	B	20mm	500mm	0.10	12	144 2016	9,80€
52473	ALARGADOR FLEXIBLE IMANTADO CON LED	C	15mm	545mm	0.18	10	60 960	9,90€



HERRAMIENTAS DE INSPECCIÓN

REF.	DESCRIPCIÓN	Ø	—					€
51272	EXTENSIBLE IMANTADO CON PUNTA DE LED	A	18mm	90-810mm	0.05	12	72 1512	7,50€
52472	PUNTA IMANTADA EXTENSIBLE	B	10mm	135-600mm	0.15	12	108 4320	4,90€
52468	ESPEJO DE INSPECCIÓN TELESCÓPICO ARTICULADO	C	50mm	280-445mm	0.09	12	48 1536	5,90€



15706

31,00€

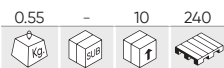

MÓDULO EVA DE HERRAMIENTAS MAGNÉTICAS DE RECOGIDA



15799

28,30€



MÓDULO DE MARTILLOS EVA EN FIBRA DE CARBONO



MARTILLOS PROFESIONALES CON MANGO DE FIBRA

REF.	DESCRIPCIÓN					€
52182	2Kg - 297mm	2.20	6	12	504	24,00€
52184	4Kg - 880mm	4.31	-	4	128	43,00€
52185	6Kg - 895mm	6.97	-	4	72	55,00€
52186	8Kg - 900mm	8.68	-	2	72	72,00€



MARTILLOS NYLON ANTI-REBOTE

REF.	DESCRIPCIÓN					€
52425	Ø 40mm	0.70	6	12	768	33,30€
52426	Ø 60mm	1.50	2	12	288	52,00€
52427	Ø 70mm	2.02	2	12	204	64,00€



PUNTA RECAMBIO

REF.	mm					€	REF.	mm					€	REF.	mm					€
11212	Ø 40	0.02	5	100	-	5,00€	11213	Ø 60	0.08	5	50	-	10,60€	11214	Ø 70	0.11	5	50	-	12,50€



MARTILLO DE PEÑA

REF.	DESCRIPCIÓN					€
51674	505g	0.60	6	36	864	7,75€
52565	1000g	1.13	6	24	720	11,50€



MARTILLO DE BOLA

REF.	DESCRIPCIÓN					€
51504	454g	0.55	4	40	800	8,50€
51918	1000g	1.25	6	18	648	12,50€



MARTILLOS PROFESIONALES ANTI-REBOTE

REF.	DESCRIPCIÓN					€
52180	1,35Kg - 355mm	1.45	6	12	432	19,00€
52181	1,80Kg - 370mm	1.81	6	12	300	22,50€
52183	2,20Kg - 405mm	2.30	6	12	288	26,20€



HACHAS CON MANGO DE MADERA

REF.	DESCRIPCIÓN					€
52188	360mm	0.82	4	24	875	15,50€
52460	410mm	1.17	4	24	864	16,60€
52461	700mm	2.00	4	12	240	25,70€



HERRAMIENTAS MANUALES

52830

24,00€

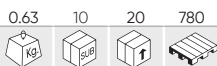

SIERRA DE ARCO CON MANGO ERGONÓMICO

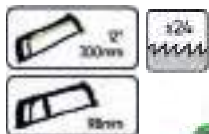

EN EXPOSITOR DE 10 UNIDADES

52831

18,00€

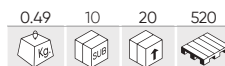

SIERRA DE ARCO

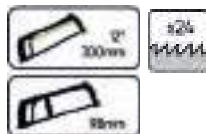

EN EXPOSITOR DE 10 UNIDADES

REF. DESCRIPCIÓN

12060 HOJA PARA SIERRA DE ARCO PARA REF.52830 / 52831

0.02 100 800 - 2,50€

53591

5,50€

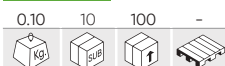

CUCHILLO PELACABLES

- Rango de corte: 8-28mm.
- Largo del producto: 170mm.
- Largo de la cuchilla: 20mm.
- Profundidad del gancho: 5mm.



52786

14,60€



NAVAJA CON SISTEMA CORTA CINTURONES Y ROMPE CRISTALES



EN EXPOSITOR DE 12 UNIDADES

CORTATUBOS

REF.	DESCRIPCIÓN	Kg	10	50	1500	€
52878	3-32mm	0.22	10	50	1500	11,20€
52879	3-35mm	0.24	10	50	1500	10,10€
52877	Ø MAX: 42mm	0.43	6	48	624	15,80€
53517	Ø MAX: 30mm	0.13	10	60	600	9,50€



52885

18,00€



JUEGO DE 12 SACABOCADOS - MÉTRICO

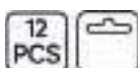

3, 4, 5, 6, 7, 8, 9, 10, 12, 14, 16, 19mm



54331

27,00€

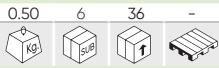

N

SET DE 3 CUTTERS PROFESIONALES

MODELO C PLEGABLE



	HOJA	TAMAÑO HOJA	LONGITUD	PESO
A	x4	60x19mm	175mm	115,5g
B	x1	100x10mm	160mm	129,7g
C	x4	60x19mm	175mm	115,5g



DESPIECE DISPONIBLE

REF.	DESCRIPCIÓN				€
16342	SET DE 10 HOJAS DE RECAMBIO PARA REF.54331	0.01	10	100	2,50€
16343	SET DE 10 HOJAS TRAPEZIO DE RECAMBIO PARA REF.54331	0.01	10	100	2,50€

51909

2,46€

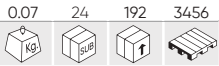

CÚTER PROFESIONAL



EN EXPOSITOR DE 24 UNIDADES



DESPIECE DISPONIBLE

REF.	DESCRIPCIÓN				€
16642	SET DE 10 HOJAS DE RECAMBIO PARA REF.51909	0.01	10	100	1,00€

CINCELES

REF.	DESCRIPCIÓN					€
53120	150mm	0.35	6	24	1200	6,00€
53121	250mm	0.55	6	24	864	7,35€
53122	350mm	0.90	6	12	720	9,50€



ACERO 45C

53083

64,00€

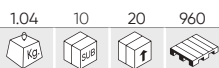

SET DE 4 CINCELES

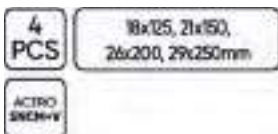

54089

17,50€



SET DE 5 CINCELES



DESPIECE DISPONIBLE

REF.	mm				€
15783	155x10	0.09	6	24	3,50€
15784	155x11	0.09	6	24	3,50€
15785	155x12	0.09	6	24	3,50€
15786	155x14	0.09	6	24	3,50€
15787	155x16	0.09	6	24	3,50€



53095

20,50€

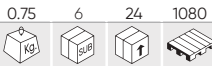

SET DE 6 BOTADORES



54099

13,80€

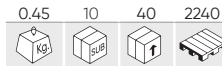

SET DE 5 BOTADORES

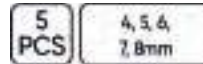

15737

45,00€

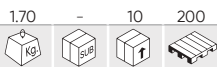

MÓDULO DE CINCELES Y PUNZONES

9 PCS

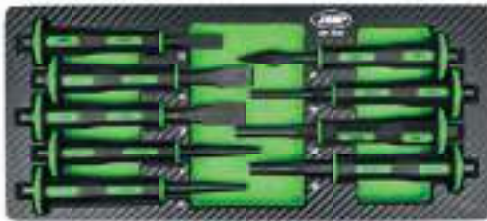

52049

14,00€

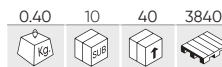

SET DE 5 PUNZONES CÓNICOS



13667

17,60€

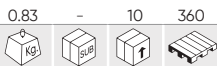

MÓDULO EVA REMACHADORA Y REMACHES



53993

77,00€

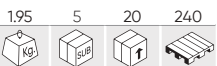

REMACHADORA ARTICULADA MULTIFUNCIÓN

Cabezal giratorio 360°
Compacta, facilita el trabajo en espacios reducidos
Diseño para trabajar con una sola mano

CONTIENE

- Boquillas para remaches estándar de 2,4mm (3/32") - 3,2mm (1/8") - 4,0mm (5/32") - 4,8mm (3/16")
- Punzones para tuercas remachables M3x0.5 - M4x0.7 - M5x0.8 - M6x1
- Punzones para remaches M6x1 - M5x0,8 - M4x0,7
- 3 llaves de 5,5x8,5mm - 12x17mm - 15x19mm
- Portamandriles M6x1 - M5x0,8 - M4x0,7 - M3x0,5



52596

114,00€

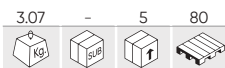

REMACHADORA DE TUERCA 400MM / 16"



52597

146,00€

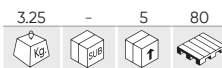

REMACHADORA DE TUERCA AUTOMÁTICA 440MM / 17"



MACHOS RECAMBIO PARA REMACHADORA DE TUERCA PARA REF. 52595, 52596 , 52597

REF.	DESCRIPCIÓN				€
13226	M3	0.03	-	100	4,50€
13227	M4	0.04	20	100	4,50€
13228	M5	0.04	20	100	4,50€
13229	M6	0.04	20	100	4,50€

REF.	DESCRIPCIÓN				€
13230	M8	0.04	20	100	4,50€
13231	M10	0.05	-	100	4,50€
13232	M12	0.05	-	100	4,50€



52463

26,10€



REMACHADORA 300MM / 12"



52464

42,00€



REMACHADORA 400MM / 16"

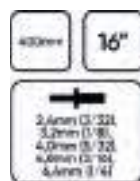

53331

31,80€



REMACHADORA DE EMPUJE 250MM / 10"



53332

34,50€



REMACHADORA DE ACORDEÓN 200MM / 8"



HERRAMIENTAS MANUALES

52595

64,00€

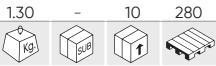

REMACHADORA TUERCA COMPACTA 200MM / 8"

200mm 8"

M3, M4, M5, M6



52462

25,30€

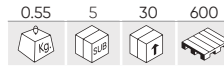

REMACHADORA COMPACTA 200MM / 8"

200mm 8"

2,4mm (3/32)
3,2mm (1/8)
4,0mm (5/32)
4,8mm (3/16)



52609

29,00€

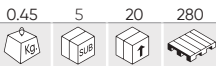

SET DE REMACHADORA + REMACHES PLÁSTICOS

Ø 6,6mm x 17,2mm (10u.)
Ø 6,3mm x 25,2mm (10u.)
Ø 5mm x 17,2mm (10u.)
Ø 5mm x 18,8mm (10u.)



DESPIECE DISPONIBLE

REF.	Ø					€
13674	6x19,3mm	0,04	25	2500	0,50€	
13675	6x17,8mm	0,01	25	500	0,50€	
13676	6x25,5mm	0,01	100	1000	0,50€	
13677	6x24,5mm	0,03	25	1000	0,50€	
13678	6x24mm	0,01	25	1000	0,50€	

52575

119,00€

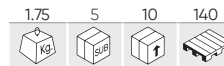

REMACHADORA NEUMÁTICA

300mm (12")
3,4mm (1/8") / 3,2mm (5/16")
4mm (5/16") / 4,8mm (1/2")

0,86 L/min

1/4" 14mm 720Kg

23-69 Nm 90 PSI 0,3 CFM 1,5 HP



- Tracción: 1586LBS / 720 KGS.
- Largo de varilla: 9/16" - 14mm.
- Máx. apriete 60FT LB / 23-69NM.
- Consumo aire medio: 0.03CFM/0.86L/Min.
- Entrada de aire: 1/4".

CONTIENE

- Cubeta trasera receptora
- 2 Multiherramientas
- Enganche rápido
- Juntas tóricas

NIVELES

DE ALUMINIO

REF.	DESCRIPCIÓN					€
53613	500mm	0.55	5	30	1260	19,50€
53614	600mm	0.60	5	30	840	21,50€
53615	800mm	0.85	5	20	600	34,60€



TUBULAR MAGNÉTICO

REF.	DESCRIPCIÓN					€
53616	500mm	0.30	5	60	1260	10,40€
53617	600mm	0.30	5	60	840	9,25€
53618	800mm	0.35	5	30	600	13,90€



EXPOSITOR PARA NIVELES

REF.					€
14183	0.80	-	10	-	31,00€

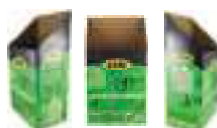

CINTA MÉTRICA

REF.	DESCRIPCIÓN					€
53025	3m x 16mm	0.13	12	48	2016	3,50€
53026	5m x 25mm	0.26	12	48	2016	5,80€
53027	7,5m x 25mm	0.40	12	48	1500	9,00€



EN EXPOSITOR DE 12 UNIDADES

52433 4,80€

0.10	10	50	1820

JUEGO DE GALGAS, 20 HOJAS 0.05-1.0 MM

0,05-1mm



52638 9,95€

0.35	5	50	1800

TENAZA PERFORADORA ROTATIVA

Ø 2, 2.5, 3, 3.5, 4, 4.5mm



52318 73,00€

0.64	6	24	336

COMPROBADOR ANGULAR DE CAÍDA IMANTADO

-6° / +6°



52904

2.00	-	5	175

PROFUNDÍMETRO CON SOPORTE MAGNÉTICO

REF.	DESCRIPCIÓN					€
13704	PROFUNDÍMETRO PARA REF. 52904	0.10	-	50	1500	21,00€



61,00€

PIE DE REY

REF.				€
50724	0.30	5	50	28,00€
50937	0.24	10	50	10,50€



150mm

50724 DIGITAL

50937 MECÁNICO

PROFUNDÍMETRO

REF.				€
52873	0.04	5	300	11,00€
53042	0.05	10	100	9,90€



52873 MECÁNICO

53042 DIGITAL

GONIÓMETRO

REF.				€
52583	0.20	4	48	8,50€
52794	0.48	6	24	28,00€



52583

52794 IMANTADO

HERRAMIENTAS MANUALES

51951

15,60€

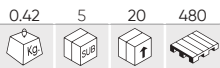

SET DE 3 ESPÁTULAS DE ACERO



53339

9,50€

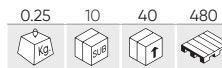

SET DE 4 ESPÁTULAS DE ACERO



53589

12,00€



GRAPADORA INDUSTRIAL



ALTURA GRAPAS: 4-14mm



52700

20,50€



SET DE ABOCARDADO DE TUBERÍAS



REF.	DESCRIPCIÓN					€
14167	PAQUETE DE 1000 GRAPAS (11.3X0.7X8MM) PARA REF.53589	0.10	50	100	-	2,50€

51853

18,00€



SET DE 5 LIMAS DE ACERO

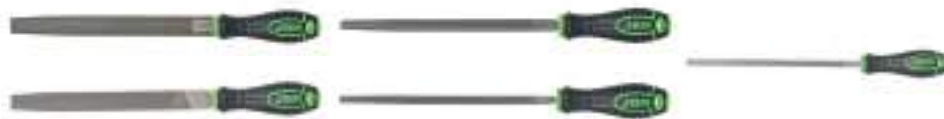

52760

4,10€



CEPILLO METÁLICO



52515

9,10€



CEPILLO METÁLICO



52905

28,00€



CURVADORA DE TUBO 6-8-10 MM

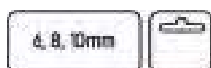

GRADOS MARCADOS

TUBOS DE ALUMINIO, COBRE Y ACERO

MOBILIARIO DE TALLER

- 72 CARROS DE HERRAMIENTAS
- 83 MÓDULOS DE HERRAMIENTAS
- 90 ACCESORIOS/RECAMBIOS
- 93 MESAS DE TRABAJO
- 95 ALMACENAMIENTO
- 99 TABURETES/CAMILLAS
- 100 YUNQUES/TORNILLOS DE BANCO



54327

2.788,00€



N

CONJUNTO DE MUEBLES MODULARES PARA TALLER (18 PCS)



CARRO DE 6 CAJONES MÓVIL CON SUPERFICIE DE GOMA

MEDIDAS GENERALES

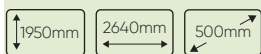

ENGANCHE CUADRADO

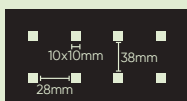

MEDIDAS ESPECÍFICAS

	A	B	C	D	E	F	G
ALTO	1890mm	340mm	340mm	38mm	900-950mm	750-880mm	900-950mm
LARGO	600mm	680mm	680mm	2040mm	680mm	666mm	680mm
ANCHO	500mm	280mm	25mm	500mm	500mm	460mm	500mm

MEDIDAS DE LOS CAJONES

	A1	B1	E1	E2	E3	F1	F2	G1
ALTO	1890mm	340mm	58mm	136mm	216mm	58mm	137mm	715mm
LARGO	600mm	680mm	567mm	567mm	567mm	567mm	567mm	596mm
ANCHO	500mm	280mm	408mm	408mm	408mm	408mm	408mm	475mm

LOS PANELES PARA HERRAMIENTAS SON COMPATIBLES CON NUESTROS GANCHOS: REF.16354, 16355, 16356, 16357



HERRAMIENTAS NO INCLUIDAS

RECAMBIOS Y ACCESORIOS

REF.	DESCRIPCIÓN					€
16490	ARMARIO ALTO (REF.54327)	56.20	-	1	-	650,00€
16491	ARMARIO ESQUINERO 800X800X338MM (REF. 54327)	22.00	-	1	-	307,00€
16492	ARMARIO ESQUINERO CON TABLERO DE MDF (REF. 54327)	59.40	-	1	-	675,00€
16493	MUEBLE CON 3 CAJONES CON PORTABOBINA DE PAPEL (REF. 54327)	41.20	-	1	-	436,00€
16494	ARMARIO DE PARED (REF. 54327)	10.40	-	1	-	139,00€
16496	TABLERO DE MDF 1360X500X38MM (REF. 16627/16628/16500)	19.40	-	1	-	127,00€
16497	TABLERO DE MDF 680X500X38MM (REF. 16627/16628/16500)	9.80	-	1	-	77,00€
16498	JUEGO DE 3 PANELES DE HERRAMIENTAS 680X338X25MM (REF. 54327)	6.00	-	1	-	84,00€
16499	JUEGO DE 6 PANELES DE HERRAMIENTAS 775X338X25MM (REF. 54327)	13.00	-	1	-	162,00€
16500	ARMARIO CON DOS PUERTAS (REF.54327)	33.60	-	1	-	463,00€
16516	SET DE 4 PANELES DE HERRAMIENTAS PARA ARMARIO ESQUINERO (REF. 16492)	9.20	-	1	-	121,00€
16561	BARRA DE SOPORTE (REF.54327)	7.80	-	4	-	36,50€
16627	ARMARIO DE 4 CAJONES (REF.54327)	43.50	-	1	-	225,00€
16628	ARMARIO DE 6 CAJONES (REF.54327)	49.00	-	1	-	382,00€
16629	MESA DE TRABAJO MDF 2040X500X38MM (REF.54327)	27.80	-	1	-	419,00€
16600	TABLERO DE ACERO INOXIDABLE 2040X500MM (REF.54327)	33.00	-	1	-	252,00€



CARRO DE HERRAMIENTAS 12 CAJONES

53939 1.280,00€

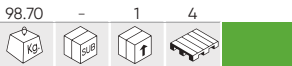

CON DOTACIÓN

172 PCS

MEDIDAS INTERIOR 1A COLUMNA

A CAJONES PEQUEÑOS (X4)



B CAJÓN MEDIANO (X1)



C CAJÓN GRANDE (X1)



MEDIDAS GENERALES DEL CARRO



53868 1.090,00€



VACÍO

172 PCS

MEDIDAS INTERIOR 2A COLUMNA

D CAJONES PEQUEÑOS (X4)



E CAJÓN MEDIANO (X1)



F CAJÓN GRANDE (X1)



ENGANCHE CUADRADO

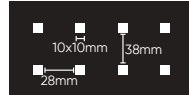

CON MÓDULOS EVA:

53708

325,00€

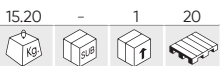

SET DE 4 MÓDULOS EVA CARBONO PARA CARRO DE HERRAMIENTAS

CONTIENE

REF.	1	4	80	€
14296	6.05	4	80	118,00€
14297	3.30	4	96	87,00€
14298	2.10	4	96	51,50€
14299	3.25	4	96	87,00€

14296



DESPIECE DISPONIBLE



14297



DESPIECE DISPONIBLE



14298



DESPIECE DISPONIBLE



14299



DESPIECE DISPONIBLE



PARA MÁS INFORMACIÓN

PÁGINA 83

CARRO DE HERRAMIENTAS 7 CAJONES - XL

53912 1.280,00€

74.50 - - 4

CON DOTACIÓN

199 PCS XL

53869 990,00€

74.50 - 1 4

VACÍO

199 PCS XL

53913 1.280,00€

74.50 - - 4

CON DOTACIÓN

199 PCS XL

53870 990,00€

74.50 - 1 4

VACÍO

199 PCS XL



MEDIDAS DEL CAJÓN

CAJONES PEQUEÑOS (X5)

74mm 705mm 400mm 25kg

CAJONES GRANDES (X2)

151,5mm 705mm 400mm 35kg

ENGANCHE CUADRADO

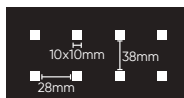

MEDIDAS GENERALES DEL CARRO

984mm 980mm 510mm



CON MÓDULOS EVA:

CONTIENE

REF.				€
14296	6.05	4	80	118,00€
14297	3.30	4	96	87,00€

REF.				€
14298	2.10	4	96	51,50€
14299	3.25	4	96	87,00€

REF.				€
15122	1.70	10	200	74,00€
15155	2.45	10	180	59,00€

REF.				€
15161	2.10	10	180	62,00€
15514	0.05	10	360	9,35€

14296

QR CODE

DESPIECE DISPONIBLE



15122

QR CODE

DESPIECE DISPONIBLE



14297

QR CODE

DESPIECE DISPONIBLE



15161

QR CODE

DESPIECE DISPONIBLE



14298

QR CODE

DESPIECE DISPONIBLE



15155

QR CODE

DESPIECE DISPONIBLE



14299

QR CODE

DESPIECE DISPONIBLE



15514



MOBILIARIO DE TALLER

CARRO DE HERRAMIENTAS 7 CAJONES VERDE

172 PCS 300kg

N

54389 790,00€

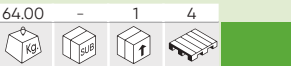

54503 490,00€



CON DOTACIÓN

VACÍO

MEDIDAS DEL CAJÓN

CAJONES PEQUEÑOS (X5)



CAJONES GRANDES (X2)



CAPACIDAD DE CARGA DEL CAJÓN: 35KG.
CAPACIDAD BANDEJA SUPERIOR DE PLÁSTICO: 300KG.

MEDIDAS GENERALES DEL CARRO



ENGANCHE CUADRADO

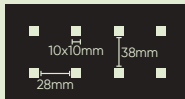

CON MÓDULOS EVA:

53708

325,00€



SET DE 4 MÓDULOS EVA CARBONO PARA CARRO DE HERRAMIENTAS

CONTIENE

REF.	kg	Box	Modules	€
14296	6.05	4	80	118,00€
14297	3.30	4	96	87,00€
14298	2.10	4	96	51,50€
14299	3.25	4	96	87,00€

14296



DESPIECE DISPONIBLE



14297



DESPIECE DISPONIBLE



14298



DESPIECE DISPONIBLE



14299



DESPIECE DISPONIBLE



PARA MÁS INFORMACIÓN

PÁGINA 83

CARRO DE HERRAMIENTAS 7 CAJONES

53661 790,00€

65.50 - 1 4

CON DOTACIÓN

53761 490,00€

52.50 - 1 4

VACÍO

53767 790,00€

56.00 - 1 4

CON DOTACIÓN

53768 490,00€

56.00 - 1 4

VACÍO

53686 790,00€

65.00 - 1 4

CON DOTACIÓN

53762 490,00€

55.50 - 1 4

VACÍO

53904 790,00€

65.00 - 1 4

CON DOTACIÓN

54006 490,00€

55.00 - 1 4

VACÍO

MEDIDAS DEL CAJÓN

CAJONES PEQUEÑOS (X5)



CAJONES GRANDES (X2)



CAPACIDAD DE CARGA DEL CAJÓN: 30KG.
CAPACIDAD BANDEJA SUPERIOR DE PLÁSTICO: 70KG.

MEDIDAS GENERALES DEL CARRO



ENGANCHE CUADRADO

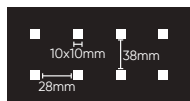

CON MÓDULOS EVA:

53708 325,00€

15.20 - 1 20

SET DE 4 MÓDULOS EVA CARBONO PARA CARRO DE HERRAMIENTAS

CONTIENE

REF.	Kg	1	20	€
14296	6.05	4	80	118,00€
14297	3.30	4	96	87,00€
14298	2.10	4	96	51,50€
14299	3.25	4	96	87,00€

14296

QR CODE

DESPIECE DISPONIBLE

14297

QR CODE

DESPIECE DISPONIBLE

14298

QR CODE

DESPIECE DISPONIBLE

14299

QR CODE

DESPIECE DISPONIBLE

PARA MÁS INFORMACIÓN

PÁGINA 83

CARRO DE HERRAMIENTAS 7 CAJONES - ESPECIAL CAMIÓN

54240 1.887,00€

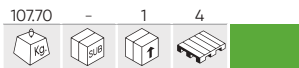

CON DOTACIÓN

54237 1.887,00€



CON DOTACIÓN

54238 1.887,00€



CON DOTACIÓN

54239 1.887,00€

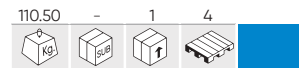

CON DOTACIÓN

MEDIDAS DEL CAJÓN

CAJONES PEQUEÑOS (X5)



CAJONES GRANDES (X2)



CAPACIDAD DE CARGA DEL CAJÓN: 30KG.
CAPACIDAD BANDEJA SUPERIOR DE PLÁSTICO: 70KG.

MEDIDAS GENERALES DEL CARRO



ENGANCHE CUADRADO

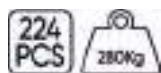
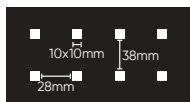

CON MÓDULOS EVA:

54134

1.415,00€

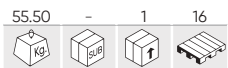

SET DE HERRAMIENTAS PARA REPARACIÓN DE CAMIÓN

CONTIENE

REF.	Box	Box	Box	€
15730	10.22	2	48	289,00€
15731	5.20	2	48	214,00€

REF.	Box	Box	Box	€
15732	6.40	2	48	293,50€
15733	3.55	2	48	113,00€

REF.	Box	Box	Box	€
15734	9.40	2	48	288,50€
15735	10.00	2	48	152,00€

REF.	Box	Box	Box	€
15736	14.80	2	40	488,50€

15730



15731



15732



15733



15734



15735



15736



PARA MÁS INFORMACIÓN

PÁGINA 84



CARRO DE HERRAMIENTAS 7 CAJONES - ESPECIAL VEHÍCULO ELÉCTRICO

54236 1.856,00€

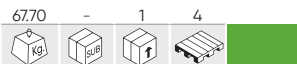

CON DOTACIÓN

54233 1.856,00€



CON DOTACIÓN

54234 1.856,00€

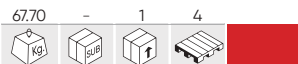

CON DOTACIÓN

54235 1.856,00€



CON DOTACIÓN

MEDIDAS DEL CAJÓN

CAJONES PEQUEÑOS (X5)



CAJONES GRANDES (X2)



CAPACIDAD DE CARGA DEL CAJÓN: 30KG.
CAPACIDAD BANDEJA SUPERIOR DE PLÁSTICO: 70KG.

MEDIDAS GENERALES DEL CARRO



ENGANCHE CUADRADO

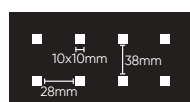

Carro especialmente configurado para cubrir todas las necesidades básicas derivadas del mantenimiento y reparación de vehículos híbridos y eléctricos, así como para trabajos en alta tensión.



CONTIENE

REF.	DESCRIPCIÓN	UNI.					€
52162	TERMÓMETRO LÁSER -50° A 550°C	1	0.17	6	72	576	38,00€
53940	POSTE DE PLÁSTICO PARA CADENA - AMARILLO/NEGRO	4	0.55	-	6	90	13,20€
54326	CADENA DE PLÁSTICO 7M - AMARILLA / NEGRA	4	0.30	-	20	720	7,30€
53942	ESLABÓN DE ENCAJE NEGRO	8	0.01	50	5000	75000	0,50€
54093	MÓDULO EVA DE HERRAMIENTAS AISLADAS VDE 26 PCS	1	3.25	-	4	80	441,00€
54114	MEDIDOR DE AISLAMIENTO	1	1.48	-	10	100	248,00€
54129	ALFOMBRA AISLANTE CLASE 0	1	0.03	10	50	-	110,00€
54130	GUANTES AISLANTES PARA TRABAJOS EN TENSIÓN T9	1	0.35	-	1	100	58,00€
54132	PANTALLA FACIAL AISLANTE PARA TRABAJOS EN TENSIÓN	1	0.70	-	1	72	190,00€
54241	PÉRTIGA DE SALVAMENTO AISLADA - 45KV	1	1.10	-	1	50	120,00€

PARA MÁS INFORMACIÓN

PÁGINA 345

CARRO DE HERRAMIENTAS 7 CAJONES - ESPECIAL KIT DE CALADO

53951 1.794,00€

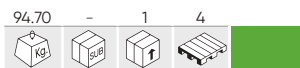

CON DOTACIÓN

53952 1.794,00€



CON DOTACIÓN

54501 1.794,00€



CON DOTACIÓN

54502 1.794,00€



CON DOTACIÓN

MEDIDAS DEL CAJÓN

CAJONES PEQUEÑOS (X5)

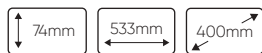

CAJONES GRANDES (X2)



CAPACIDAD DE CARGA DEL CAJÓN: 30KG.
CAPACIDAD BANDEJA SUPERIOR DE PLÁSTICO: 70KG.

MEDIDAS GENERALES DEL CARRO



ENGANCHE CUADRADO

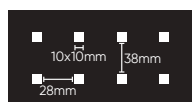

CON MÓDULOS EVA:

53775

1.109,00€

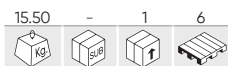

CONJUNTO DE 6 MÓDULOS DE KITS DE CALADO

CONTIENE

REF.	Kg	1	36	€
53769	5.90	3	36	178,00€
53770	6.15	3	36	198,00€

REF.	Kg	3	36	€
53771	4.05	3	36	158,00€
53772	6.40	3	36	229,00€

REF.	Kg	3	36	€
53773	6.60	3	36	298,00€
53774	6.95	3	36	190,00€

PARA MÁS INFORMACIÓN

PÁGINA 297

53769



RENAULT / NISSAN / OPEL / VOLVO

53770



FORD / SEAT / VOLKSWAGEN / MAZDA / VOLVO

53771



FIAT / FORD / CITROËN / PEUGEOT

53772



FORD / VAG / MAZDA / VOLVO

53773



FIAT / ALFA / LANCIA / OPEL / SUZUKI / FORD

53774



OPEL / CHEVROLET / SAAB / FIAT / LANCIA / SUZUKI / FORD

54295

500,00€



N

CARRO DE HERRAMIENTAS 7 CAJONES IGUALES VERDE - VACÍO

MEDIDAS GENERALES DEL CARRO

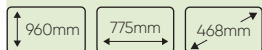

ENGANCHE CUADRADO

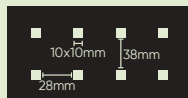

MEDIDAS DEL CAJÓN



54296

520,00€



N

CARRO DE HERRAMIENTAS 8 CAJONES IGUALES VERDE - VACÍO

MEDIDAS GENERALES DEL CARRO



ENGANCHE CUADRADO

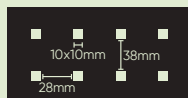

MEDIDAS DEL CAJÓN



54297

540,00€



N

CARRO DE HERRAMIENTAS 9 CAJONES IGUALES VERDE - VACÍO

MEDIDAS GENERALES DEL CARRO

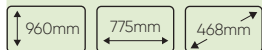

ENGANCHE CUADRADO

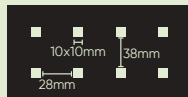

MEDIDAS DEL CAJÓN



53672

440,00€

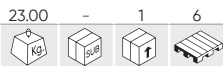

97 PCS

CARRO MODULAR



3 MÓDULOS INDEPENDIENTES EQUIPADOS CON:



	1/2"	x11	8,10,11,12,13,14,16,17,19,21,22mm
	1/4"	x13	4,4.5,5,5.5,6,7,8,9,10,11,12,13,14mm
	1/2"	x1	
	1/4"	x1	
	1/2"	x2	125,300mm
	1/4"	x2	50,100mm
		x1	180mm
		x1	160mm
		x2	160mm, 180mm
		x2	PH2x125, PH1x100mm
		x2	6x150mm, 5x100mm
		x9	8,9,10,11,12,13,14,17,19mm
		x1	250mm
		x1	300g
		x1	250mm
		x1	200mm
		x8	1,5x8mm
		x1	3mm
	1/4"	x32	
	1/4"	x1	
	1/4"	x1	
	1/4"	x1	
	1/2"	x1	
	1/4"	x1	



A CAJA DE HERRAMIENTAS EN MÓDULOS EVA + BANDEJA SUPERIOR EXTRAÍBLE

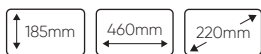

B 2 CAJONES CON HERRAMIENTAS EN MÓDULOS EVA



C COMPARTIMENTO DE APERTURA FRONTAL



53867

1.095,00€



CARRO DE HERRAMIENTAS CON 9 CAJONES CON SEPARADORES - VERDE

MEDIDAS GENERALES DEL CARRO

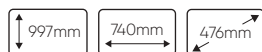

MEDIDAS DEL CAJÓN



REF.	mm	UNI.			€
15073	174x53mm	21	0.05	200	1,00€
15076	396x53mm	18	0.30	50	3,50€

TAMBIÉN TE PUEDE INTERESAR...

REF.	mm			€
15070	67x53mm	0.05	200	0,50€
15071	103x53mm	0.05	200	0,60€
15072	138x53mm	0.05	200	0,70€
15074	210x53mm	0.10	200	1,00€
15075	280x53mm	0.10	200	1,20€



CON SEPARADORES ORGANIZACIÓN LIBRE



ENGANCHE CUADRADO

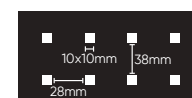



MÓDULOS EVA CON ACABADO EN FIBRA DE CARBONO

53708 325,00€

15.20 - 1 20

SET DE 4 MÓDULOS EVA CARBONO PARA CARRO DE HERRAMIENTAS

CONTIENE

14296 118,00€

6.05 - 4 80

	1/2"	x17	x10, 11, 12, 13, 14, 15, 16, 17, 18, 19, 20, 21, 22, 24, 27, 30, 32mm
	1/4"	x13	4, 4.5, 5, 5.5, 6, 7, 8, 9, 10, 11, 12, 13, 14mm
	1/2"	x5	14, 15, 17, 19, 22mm
	1/4"	x8	6, 7, 8, 9, 10, 11, 12, 13mm
	1/2"	x8	E10, E11, E12, E14, E16, E18, E20, E24
	1/4"	x5	E4, E5, E6, E7, E8
	7/16"	x2	1/2" - 1/4"
	1/2"	x2	125, 250mm
	1/4"	x2	50, 100mm
		x2	
	1/2"	x1	
	1/2"	x2	16, 21mm

		x2	PH1, PH2
		x2	PZ1, PZ2
	1/4"	x4	3, 4, 5, 6mm
		x3	SL4, SL5.5, SL6.5
		x8	T8, T10, T15, T20, T25, T27, T30
		x2	PH3, PH4
		x2	PZ3, PZ4
	8mm	x5	7, 8, 10, 12, 14mm
		x3	SL8, SL10, SL12
		x5	T40, T45, T50, T55, T60
		x1	1/4"
		x1	1/4"
	1/2"	x1	8mm
		x3	1.5, 2, 2.5mm



14297 87,00€

3.30 - 4 96

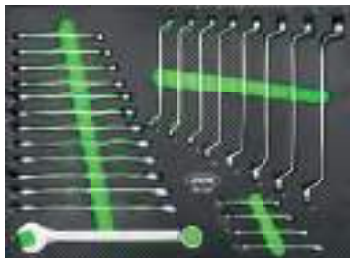

	6x7, 8x9, 10x11, 12x13, 14x15, 16x17, 18x19, 20x22mm
	6, 7, 8, 10, 11, 12, 13, 14, 15, 17, 19, 22mm

14298 51,50€

2.10 - 4 96



	PH0x75, PH1x100, PH2x100, PH3x150, PH4x200
	6, 7, 8, 10, 11, 12, 13, 14, 15, 17, 19, 22mm
	2x38mm
	6x38mm
	1.5, 2, 2.5, 3, 4, 5, 6, 8, 10mm
	10, 15, 20, 25, 27, 30, 40, 45, 50mm

14299 87,00€

3.25 - 4 96



	35mm		8"
	450g		10"
	10"		7.5"
	8"		3m
	8"		

54134

1.415,00€

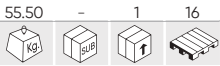

SET DE HERRAMIENTAS PARA REPARACIÓN DE CAMIÓN

CONTIENE

15730

289,00€

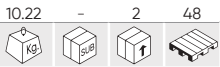

	55mm	H5, H6, H7, H8, H10, H12		1/2"	x3	50, 125, 250mm
	65mm	H14		1/2"	x1	430mm
	70mm	H16, H17, H18, H18, H20		1/2"	x1	10mm
	30mm	H4, H5, H6, H7, H8, H10, H12		3/4"	x5	21, 24, 27, 34, 36mm
	30mm	M5, M6, M8, M10, M12		3/4"	x4	24, 30, 32, 36 mm
	75mm	T20, T25, T30, T40, T45, T50, T55				1/2x10, 3/8x10mm
	75mm	H4, H5, H6, H7, H8, H10, H12				1/2x10, 3/8x10mm
	75mm	M5, M6, M8, M10, M12				10mm
	1/2"	x9		3/8"		300, 380, 450mm
	1/2"	x10		1/4"		300, 380, 450mm
				1/4"		1/2"

15731

214,00€

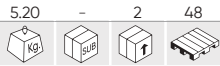

	6x7, 8x9, 10x11, 12x13, 14x15, 16x17, 18x19, 20x22, 21x23, 24x27, 25x28, 30x32mm
	6, 7, 8, 10, 11, 12, 13, 14, 15, 17, 19, 22, 24mm

15732

293,50€

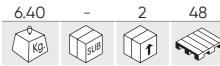

	10, 13, 17mm
	10x11, 12x13, 14x17mm
	E10xE12, E14xE18, E20xE24
	8x10, 11x13, 14x15, 16x17, 18x19mm
	27, 30, 32, 36mm
	10, 13, 17, 19mm

15733

113,00€

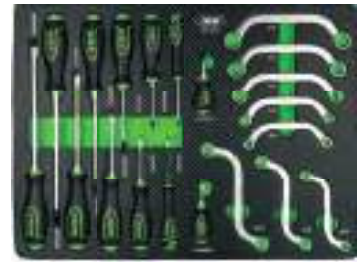
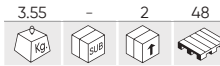

	PH0x75mm, PH1x75mm, PH2x100mm, PH2x38mm, PH3x150mm, PH4x200mm
	SL3.5x75mm, SL5x75mm, SL6x100mm, SL6x38mm, SL8x150mm, SL9.5x200mm
	10x11, 12x13, 14x15mm
	10x11, 12x13, 14x15, 16x17, 18x19mm

15734

288,50€



	1kg
	24, 27, 30, 32, 36, 41mm
	3/4" 500mm
	3/4" 500mm
	1.5, 2, 2.5, 3, 4, 5, 6, 8, 10mm

15735

152,00€

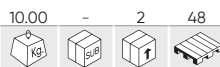

	220mm		250mm
	330mm		6" - 160mm
	330mm		7" - 180mm
	330mm		0°/45°/90°
	330mm		300mm

15736

488,50€



	1/2"	78mm	13, 14, 15, 16, 17, 18, 19, 21, 22, 24mm
	3/4"	78mm	22, 24, 27, 30, 32, 33, 36, 38, 46mm
	1/2"	90mm	51, 60mm
	1/2"	90mm	T40, T45, T50, T60, T70
	1/2"	78mm	H6, H8, H14, H17
	3/4"	100mm	T80, T90, T100
	1/2"	40mm	M18
	1/2"(M)x3/4"(H)	3/4"(M)x1/2"(H)	
	1/2" - 3/4"		125mm

15681

134,00€

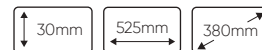
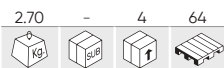

	H3, H4, H5, H6, H7, H8		7, 8, 10, 12, 14mm
	M8, M10, M12		PH3, PH4
	PH0, PH1, PH2, PH3		PZ3, PZ4
	PZ0, PZ1, PZ2, PZ3		8mm
	1/2"		SL8, SL10, SL12
	SL4, SL5.5, SL6.5, SL7		T40, T45, T50, T55, T60, T70
	T8, T9, T10, T15, T20, T25, T27, T30, T40		T40, T45, T50, T55, T60, T70
	T8, T9, T10, T15, T20, T25, T27, T30, T40		H7 (230mmL), H10, H11, H13 (140mmL), H14, H17, H19, H22, H24 (55mmL)
	TS10, TS15, TS20, TS25, TS27, TS30, TS40, TS45, TS50		M9 (100mmL), M10, M12, M14 (140mmL), M16 (53mmL), M16 (100mmL)
	1/2" 8mm		1/2"
	3/8" 8mm		R7, R8 (240mmL), R9 (100mmL), R10 (140mmL)
	1/4" 6mm		T30 (300mmL), T40, T45, T50, T55, T60, T70 (140mmL), T80 (100mmL)
	1/2" M18		HT5 (160mmL)



15122 74,00€

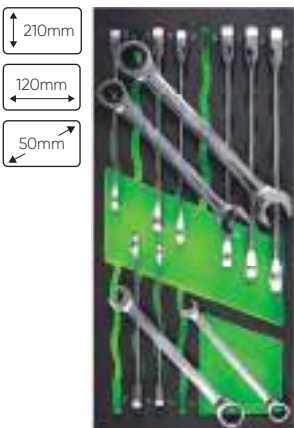
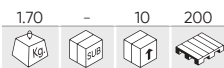

x12 8, 9, 10, 11, 12, 13, 14, 15, 16, 17, 18, 19mm

15155 59,00€

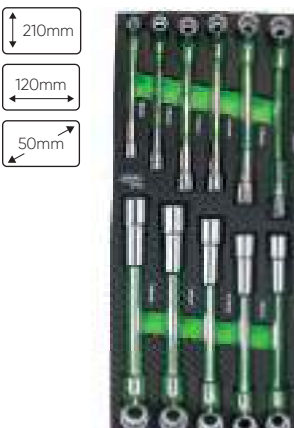
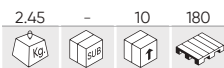

x11 8, 10, 11, 12, 13, 14, 15, 16, 17, 18, 19mm

15156 70,00€

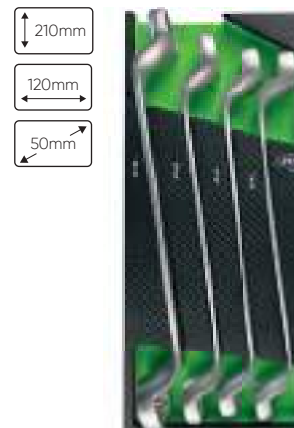

x4 21x23, 24x27, 25x28, 30x32mm

15157 42,00€

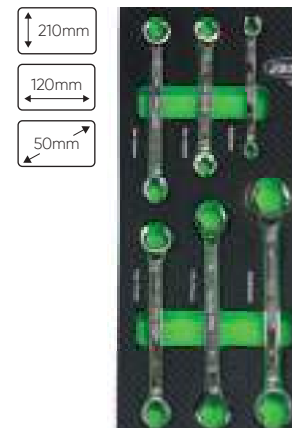

x7 6x8, 10x12, 13x14, 15x17, 19x21, 22x24mm

15158 59,00€

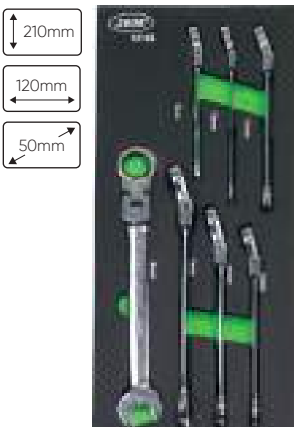

x7 8, 10, 11, 13, 14, 17, 19mm

15159 44,00€

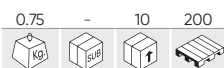

x5 8x10, 11x13, 14x15, 17x19, 20x22mm

15160 42,00€

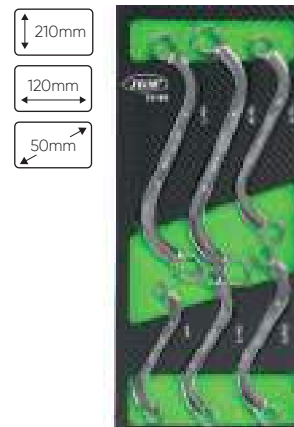

x6 8x9, 10x11, 12x13, 14x15, 16x17, 18x19mm

15161 62,00€

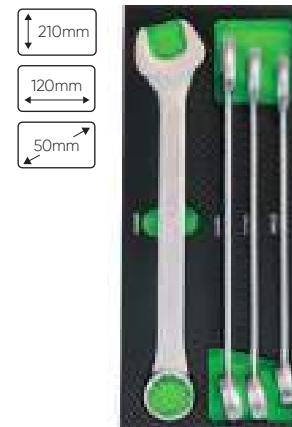

x4 27, 29, 30, 32mm

15316 58,00€

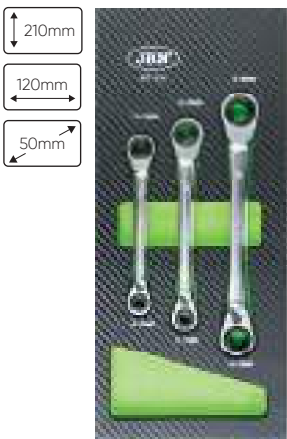
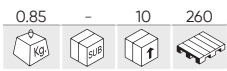

x3 8, 9, 10, 11, 12, 13, 14, 15, 16, 17, 18, 19mm

53943 21,50€

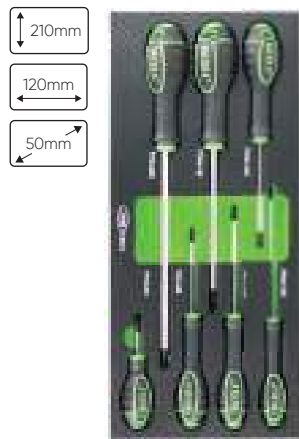
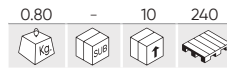

x7 PH4x200, PH3x150, PH2x100, PH2x38 PH1x80, PH0x120, PH1x100

53944 19,50€

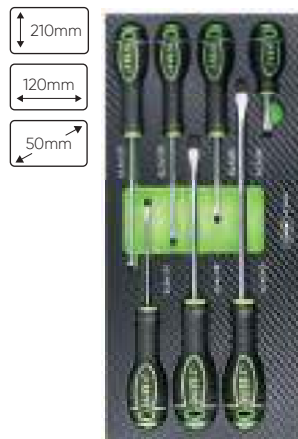

x7 SL9x200, SL4x125, SL5x100, SL5x80, SL6x38, SL6x100, SL8x150mm

53945 18,90€

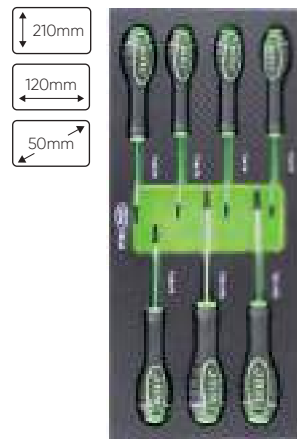
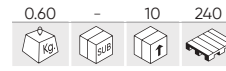

x7 T8x75, T9x75, T10x75, T15x75, T20x75, T25x100, T27x100

15454 35,40€

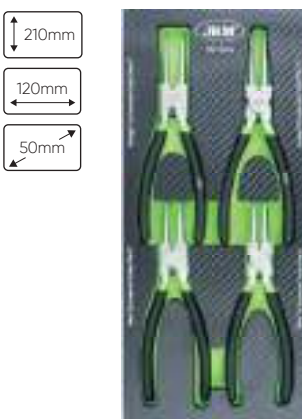
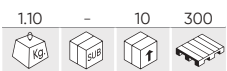

x1 8" x1 8"
x1 8" x1 8"

15541 27,60€

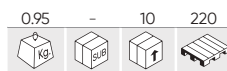

x1 7" - 180mm
x1 8" - 200mm
x1 8" - 200mm

15706 31,00€

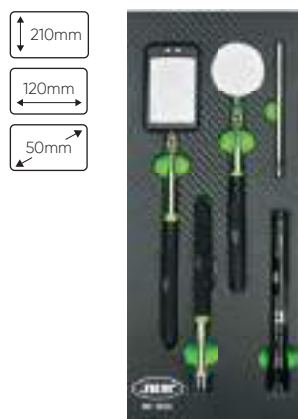

x1 180 - 770mm
x1 130 - 640mm
x1 280 - 870mm
x1 170 - 580mm
x1 495mm

15737 45,00€

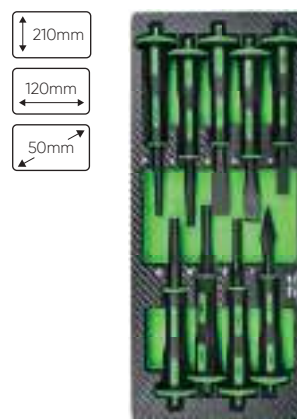
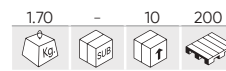

x1 6x180mm
x2 8x180, 10x180mm
x3 6x180, 8x180, 10x180mm
x3 2x160, 16x175, 19x180mm

15315 28,20€

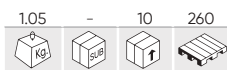

x1 8" x1 8"
x1 8" x1 8"
x1 8"

15514 9,35€

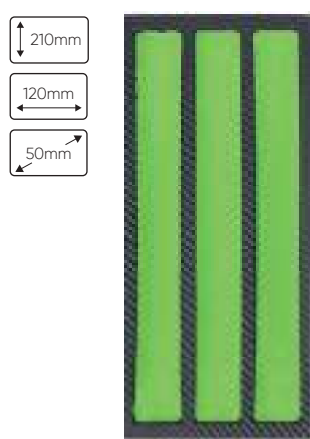

VACIO

54158 38,00€

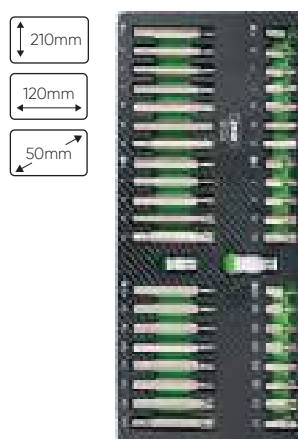

3/8" x1 10mm
1/2" x1 10mm
30mm x7 4, 5, 6, 7, 8, 10, 12mm
75mm x7 4, 5, 6, 7, 8, 10, 12mm
30mm x8 T20, T25, T30, T40, T45, T50, T55, T60
75mm x8 T20, T25, T30, T40, T45, T50, T55, T60
30mm x5 M5, M6, M8, M10, M12
15mm x5 M5, M6, M8, M10, M12

15162 30,20€

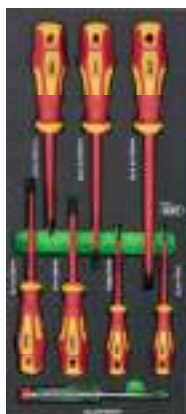
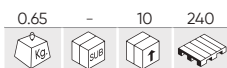

- ⊖ **x4** SL3x75, SL4x100, SL5.5x125, SL6.5x150mm
- ⊕ **x3** PH0x75, PH1x80, PH2x100mm
- 🔧 **x1** 140mm

54093

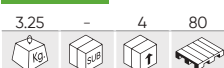

- 🔩 **3/8"** x10 45mm 8, 10, 11, 12, 13, 14, 16, 17, 18, 19, 21, 22mm
- 🔩 **x2** 4x100, 5,5x125mmL
- 🔩 **x2** PH1x80, PH2x100mm
- 🔩 **x1** 185mm
- 🔩 **x1** 52mm
- 🔩 **x1** 185mm
- 🔩 **x6** 7x86, 8x99, 10x109, 12x127, 14x141, 17x156mm
- 🔩 **1/2"** **x1** 125mm
- 🔩 **3/8"** **x1** 200mm
- 🔩 **3/8"** **x1** 200mm

15799 28,30€



- 🔧 **x1** 450g
- 🔧 **x1** 35mm

16111 19,20€

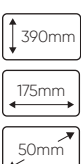

- 🔧 **x1** 220mm
- 🔩 BV1.25
- 🔩 BV2
- 🔩 RV2-4
- 🔩 RV2-4L
- 🔩 SV2-4
- 🔩 SV5.5-6
- 🔩 MDD2-250
- 🔩 FDD2-250

51805 17,00€



- 🔩 **x5** 50, 75, 100, 152, 227mm

51447 16,00€



- 🔩 **x5** 50, 75, 100, 152, 227mm

51448 52,00€



- 🔩 **x5** 50, 125, 250, 380, 510mm

52912 91,00€

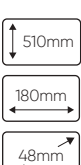

- 🔩 **x6** E6xE7 (200mmL), E8xE10 (235mmL), E11xE12 (290mmL), E14xE16 (370mmL), E18xE20 (410mmL), E22xE24 (420mmL)

54066 83,00€



- 🔩 **x7** 8mm (23,5mmL), 10mm (29,3mmL), 12mm (32,8mmL), 13mm (34,9mmL), 14mm (36,7mmL), 17mm (41mmL), 19mm (42mmL)

51864 64,00€



- 🔩 **x6** 10x11mm (290mmL), 12x14mm (330mmL), 13x15mm (368mmL), 16x18mm (407mmL), 17x19mm (407mmL), 22x24mm (430mmL)

MOBILIARIO DE TALLER

54032 84,00€

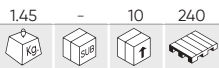

400mm
180mm
50mm



x12 8mm (89mmL), 9mm (94mmL), 10mm (95mmL), 11mm (99mmL), 12mm (102mmL), 13mm (107mmL), 14mm (114mmL), 15mm (117mmL), 16mm (123mmL), 17mm (125mmL), 18mm (130mmL), 19mm (135mmL)

15083 8,50€

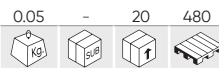

380mm
175mm
50mm



VACÍO

15084 68,00€

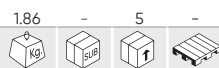

380mm
175mm
50mm



x2 5/16", 3/8"
x7 7, 8, 10, 11, 12, 13, 14mm
x1 10mm
x1 10mm
x7 8, 9, 10, 12, 13, 14, 17mm
x1 T45
x1 M16
x1 200mm x1 150mm

53979 34,60€

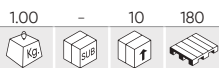

390mm
340mm
50mm



x8 T10x75, T15x75, T20x100, T25x100, T30x150, T40x150, T45x200, T50x200mm

53980 34,60€

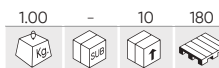

390mm
340mm
50mm



x8 H2x100, H2.5x100, H3x100, H4x150, H5x150, H6x200, H8x200, H10x200

MÓDULOS EVA

11996 48,00€



390mm
175mm
50mm



x10 6x7, 8x9, 10x11, 12x13, 14x15, 16x17, 18x19, 20x22, 24x27, 30x32mm

11997 39,00€



390mm
175mm
50mm



x8 6x7, 8x9, 10x11, 12x13, 14x15, 16x17, 18x19, 20x22mm

11998 49,00€



390mm
175mm
50mm

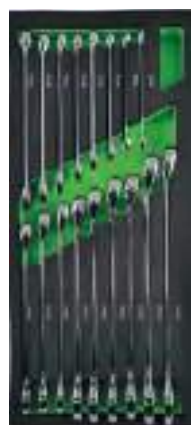

x17 6, 7, 8, 9, 10, 11, 12, 13, 14, 15, 16, 17, 18, 19, 20, 21, 22mm

13668 18,70€



390mm
175mm
50mm



x1 3m
x1 230mm
x1 50mm
x1 250mm

11994 33,00€

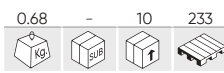

- x1 1/4"
- x1 1/4"
- x1 1/4"
- x13 4, 4.5, 5, 5.5, 6, 7, 8, 9, 10, 11, 12, 13, 14mm
- x1 250mm
- x1 125mm

14114 19,30€

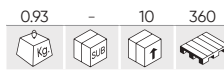

- x1 10"
- x1 10"

13667 17,60€

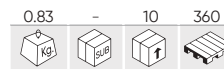

- x1 253mm
- 2x6, 3x7, 3x9, 6x10mm

13923 7,45€

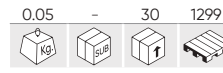

VACÍO

53671 41,00€

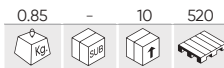

- x3 1/4" - 85 mm
- 1/2" - 135 mm
- 3/8" - 102 mm

53620 88,00€



- x17 6, 7, 8, 9, 10, 11, 12, 13, 14, 15, 16, 17, 18, 19, 20, 21, 22mm
- x8 6x7, 8x9, 10x11, 12x13, 14x15, 16x17, 18x19, 20x22mm

MÓDULOS PLÁSTICO

10732 18,70€

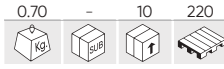

- x1 3m
- x1 230mm
- x1 50mm
- x1 250mm

10735 20,30€

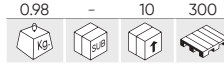

- x1 8"
- x1 8"
- x1 8"
- x1 8"
- x1 8"
- x1 8"

PANEL PARA HERRAMIENTAS

REF.	mm					€
52419	A 1000x600mm	7.07	-	1	30	80,00€
52420	B 1500x600mm	10.80	-	2	35	108,00€
52421	C 2000x600mm	14.00	-	1	38	172,00€

ENGANCHE CUADRADO

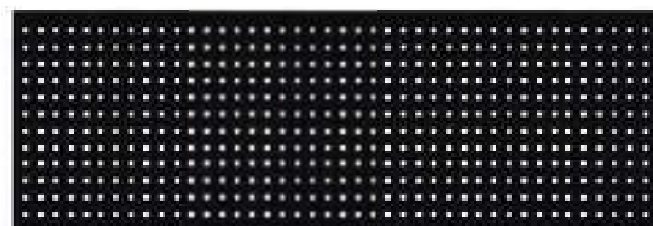

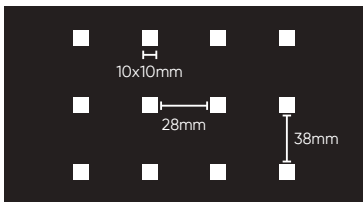

15068 15,20€



15069 32,80€



15313 14,00€

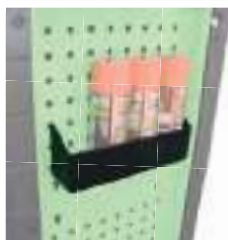
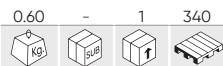

14354 14,00€



16359 10,00€



16361 16,50€



16362 20,00€



16363 14,50€



16344 43,00€



16358 12,00€



16360 12,00€



16354 1,50€

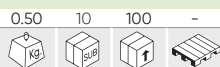

16355 2,00€



16356 2,50€



16357 2,50€

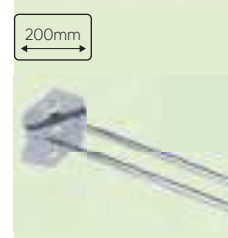
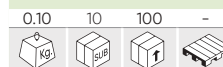

ACCESORIOS

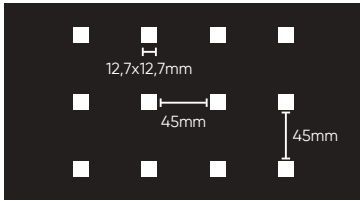

16161 17,50€

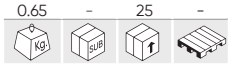

16162 35,10€

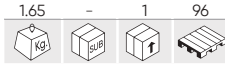

16163 10,20€

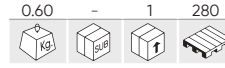

16188 39,60€

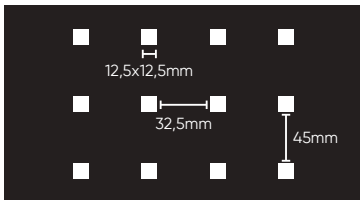
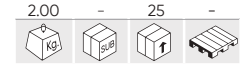

51655 4,10€

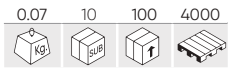

51976 1,63€

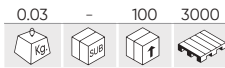

51658 4,50€

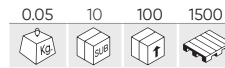

51422 2,97€



52634 5,25€

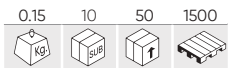

51975 2,27€

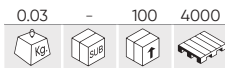

51419 2,79€

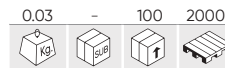

51656 3,65€



51654 4,80€

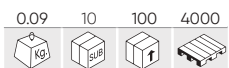

52635 4,80€

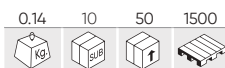

51657 5,85€

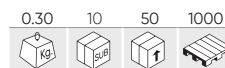

51653 5,10€



RECAMBIOS

REF.	DESCRIPCIÓN					€
14578	JUEGO DE 2 GUIAS CAJÓN GRANDE PARA 53661, 53686, 53904, 54006	1.05	-	25	-	12,50€
14580	TAPA SUPERIOR PARA REF. 53661, 53686, 53904, 54006, 54389	2.60	-	3	39	41,00€
14783	PROTECTOR LATERAL DERECHO PARA REF. 53686, 53661, 53904, 54006, 54389	0.25	-	50	-	5,50€
15023	RUEDA FIJA PARA REF. 53765, 53766, 53870	0.65	-	10	-	12,50€
15024	RUEDA GIRATORIA PAR REF. 53765, 53766, 53870	0.95	-	8	-	15,00€
15025	RUEDA FIJA PARA REF. 53900, 53901	0.65	-	10	-	12,50€
15026	RUEDA GIRATORIA PARA REF. 53900, 53901	0.95	-	8	-	15,00€
15030	TIRADOR DE CAJÓN PARA REF. 53765, 53766	0.30	-	50	-	8,00€
15033	TIRADOR DE CAJÓN ESTRECHO PARA REF. 53868	0.14	-	50	-	6,00€
15034	TAPA SUPERIOR PARA REF. 53868	2.00	-	2	-	57,00€
15035	TIRADOR DE CAJÓN PARA REF. 53869	0.36	-	20	-	8,50€
15036	TIRADOR DE CAJÓN PARA REF. 53870	0.36	-	20	-	8,50€
15037	TIRADOR DE CAJÓN PARA REF. 53900, 53901	0.10	-	-	-	8,00€
15038	TAPA SUPERIOR PARA REF. 53869, 53870	2.00	-	2	-	34,50€
15040	RUEDA FIJA PARA REF. 53904, 54006, 54389	0.66	-	10	-	12,50€
15041	RUEDA GIRATORIA PARA REF. 53904, 54006, 54389	0.98	-	8	-	15,00€
15042	TIRADOR DE CAJÓN PARA REF. 53904, 54006	0.10	-	1	-	7,50€
15050	TIRADOR DE CAJÓN PARA REF. 53661, 53686	0.10	-	50	-	9,50€
15058	PROTECTOR LATERAL PARA REF. 53868	0.36	-	-	-	7,50€
15065	PROTECTOR LATERAL PARA REF. 53869, 53870	0.28	-	12	-	6,50€
16387	TIRADOR DE CAJÓN PARA REF.54389	0.40	-	-	-	10,50€



CANDADOS

CORTOS

REF.	DESCRIPCIÓN					€
53403	38mm	0.15	8	96	3168	6,50€
53405	32mm	0.10	8	96	3168	5,30€
53406	50mm	0.30	8	48	1728	8,55€
53407	63mm	0.35	8	48	3168	12,70€
53408	75mm	0.48	3	24	840	19,30€

LARGOS

REF.	DESCRIPCIÓN					€
53404	38mm	0.15	8	96	3168	6,50€
53409	50mm	0.30	8	48	3168	9,00€

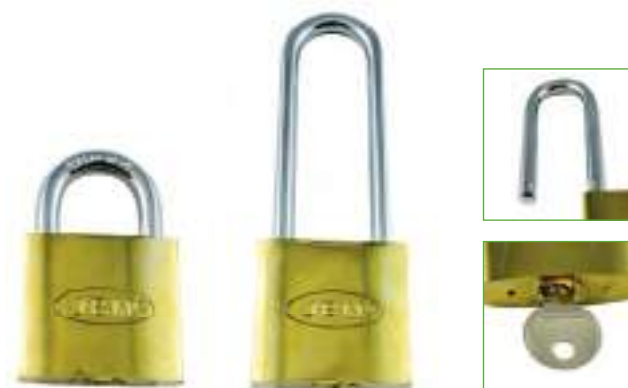

CANDADOS RESISTENTES AL AGUA

REF.	DESCRIPCIÓN					€
53399	30mm	0.90	8	48	3168	3,50€
53400	40mm	0.20	8	48	499	5,70€
53401	50mm	0.35	8	48	499	7,40€
53402	65mm	0.05	10	40	499	9,60€



54388

366,00€

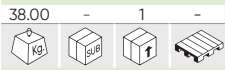

CARRO PARA DIAGNÓSTICO

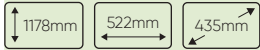

Carro multifunción para taller con cuatro bandejas y un compartimento cerrado con llave. Es adecuado para colocar ordenadores portátiles, testers y cargadores de batería.

Dispone de dos mangos y ruedas giratorias que facilitan el traslado de una manera muy cómoda. También incluye un panel perforado, un portabobina de papel y dos bandejas laterales para guardar herramientas.

MEDIDAS BANDEJA SUPERIOR	433x398mm
MEDIDAS PANEL PERFORADO	430x475mm
TOTAL BANDEJAS	4
CAPACIDAD BANDEJA SUPERIOR	20Kg
DIÁMETRO RUEDAS	101mm
RUEDAS CON FRENOS	2



N

REF. DESCRIPCIÓN

REF. DESCRIPCIÓN	Kg	Sub	U	€
16481 RUEDA GIRATORIA CON FRENO (REF.54388)	11.60	-	20	14,00€
16482 RUEDA (REF. 54388)	2.80	-	20	13,50€

51576

125,00€

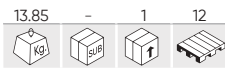

CARRO CON 3 BANDEJAS



52373

252,00€

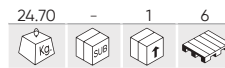

CARRO CON 3 BANDEJAS MAXI



51738

850,00€

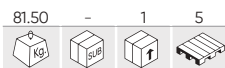

MESA DE TRABAJO DE 3 CAJONES

MEDIDAS GENERALES



MEDIDAS CAJÓN



REF. DESCRIPCIÓN

REF. DESCRIPCIÓN	Kg	Sub	U	€
15144 ALFOMBRA DE GOMA PARA MESA DE TRABAJO REF. 51738	2.50	-	100	30,00€

51737

699,00€

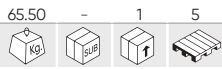

MESA DE TRABAJO DE 2 CAJONES



MEDIDAS GENERALES



MEDIDAS CAJÓN



REF. DESCRIPCIÓN

REF.	DESCRIPCIÓN	1	2	3	4	5	€
15145	SET DE 2 ALFOMBRAS DE GOMA PARA MESA DE TRABAJO REF. 51737	1.90	-	100	100	20,45€	

53674

447,00€

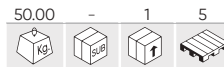

MESA DE TRABAJO DE 1 CAJÓN



MEDIDAS GENERALES



MEDIDAS CAJÓN



REF. DESCRIPCIÓN

REF.	DESCRIPCIÓN	1	2	3	4	5	€
15146	ALFOMBRA DE GOMA PARA MESA DE TRABAJO REF. 53674	1.35	-	100	100	16,20€	

51035

799,00€



MESA DE TRABAJO CON PANEL FRONTAL



MEDIDAS GENERALES



ENGANCHE CUADRADO

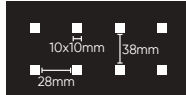

MEDIDAS CAJÓN

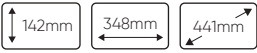

54328

199,00€



MESA DE TRABAJO PLEGABLE CON PANEL FRONTAL



N

MEDIDAS GENERALES

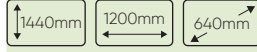

ENGANCHE CUADRADO

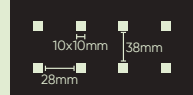

MEDIDAS PLEGADO

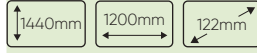

SUPERFICIE DE TRABAJO



HERRAMIENTAS NO INCLUIDAS

50957

22,00€

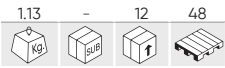

CAJA 24+2 COMPARTIMENTOS



- 24 compartimentos de 8x5,5 cm.
- 2 compartimentos de 15x7,5 cm.
- Abatible de 26 a 5 separaciones.

50959

14,00€

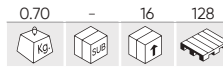

CAJA 20+1 COMPARTIMENTOS



- 20 compartimentos de 6x7 cm.
- 1 compartimento de 35x7 cm.
- Abatible a 4 separaciones.

51051

34,80€

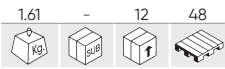

ORGANIZADOR DE 5 COMPARTIMENTOS



CAJONES
INSEPARABLES

51050

285,00€

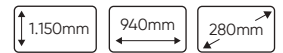
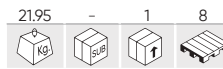

ORGANIZADOR DE PIE - 47
COMPARTIMENTOS

COMPARTIMENTOS PEQUEÑOS

Total: 32
Medidas: 16x10x7.5 cm
Medidas del estante: 84x16x8 cm
Total estantes: 4

COMPARTIMENTOS GRANDES

Total: 15
Medidas: 24x14.5x13 cm
Medidas del estante: 84x14x24 cm
Total estantes: 3



51574

52,00€

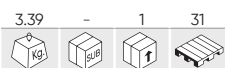

CAJA PARA HERRAMIENTAS CON 5
COMPARTIMENTOS



MEDIDAS GENERALES



CAJA ABIERTA



CAJA PARA HERRAMIENTAS

REF.						€
54393	750x200x220mm - 9Kg	7.70	-	1	15	92,00€
54394	530x200x220mm - 5,2Kg	5.70	-	1	22	64,00€
54395	450x200x220mm - 4,5Kg	6.20	-	1	24	53,00€



MOBILIARIO DE TALLER

51575

317,00€

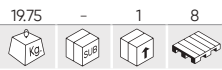

CAJA PARA HERRAMIENTAS CON 6 CAJONES

MEDIDAS GENERALES

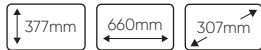

CAJONES PEQUEÑOS (X3)

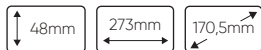

CAJÓN MEDIANO (X2)

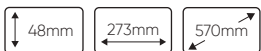

CAJÓN GRANDE (X1)



51600

109,00€

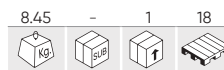

CAJA PARA HERRAMIENTAS CON 3 CAJONES

MEDIDAS GENERALES

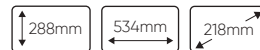

MEDIDAS CAJÓN



53782

14,00€

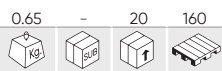

BOLSA PARA HERRAMIENTAS - GRANDE



53253

98,00€



MALETA DE HERRAMIENTAS



54080

53,50€

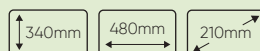

N

BOLSA PARA HERRAMIENTAS

20L



54374

75,50€



N

MOCHILA PARA HERRAMIENTAS

15 Kg





BOLSAS PARA HERRAMIENTAS

REF.	DESCRIPCIÓN					€
53702	BOLSA PARA HERRAMIENTAS - PEQUEÑA	1.00	-	5	180	28,50€
53703	BOLSA PARA HERRAMIENTAS - MEDIANA	1.40	-	5	120	41,00€
53704	BOLSA PARA HERRAMIENTAS - GRANDE	1.65	-	5	120	42,00€

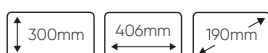

53903

59,00€

1.65	-	10	100

SET DE 3 BANDEJAS DE HERRAMIENTAS FLEXIBLES ANTIDESLIZANTES

3 PCS



REF.	DESCRIPCIÓN					€
15010	285x137x27mm	0.40	-	20	360	16,50€
15011	285x202x27mm	0.45	-	20	320	18,00€
15012	543x300x27mm	1.05	-	10	120	31,50€

MOBILIARIO DE TALLER

BANDEJA FLEXIBLE MAGNÉTICA

REF.	Ø SUPERIOR	Ø BASE	MEDIDAS DESPLEGADO	MEDIDAS PLEGADO					€
52516	225mm	88mm	135mm	43mm	0.42	6	24	1152	28,00€
52517	135mm	53mm	90mm	31mm	0.10	12	72	1152	6,00€



50787 8,00€

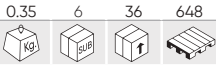

BANDEJA IMANTADA Ø150MM



50788 14,50€

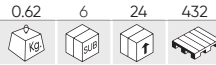

BANDEJA IMANTADA



52466 11,00€

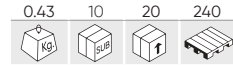

RECIPIENTE MAGNÉTICO

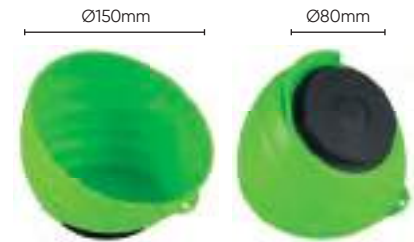

53958 6,50€

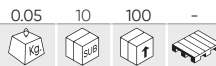

SET DE 5 IMANES



50789 29,00€

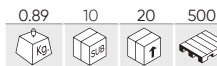

BARRA MAGNÉTICA PARA HERRAMIENTAS



53192 52,00€

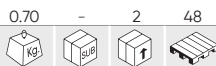

COLCHONETA DESPLEGABLE



MEDIDAS GENERALES

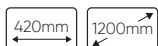

MEDIDAS PLEGADO

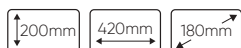

- DE ESPUMA EVA.

53191 14,80€



COLCHONETA INDIVIDUAL



MEDIDAS GENERALES



- DE ESPUMA EVA.

50843

79,00€

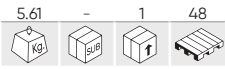

ASIENTO NIVELABLE NEUMÁTICO



Ø 295mm

Ø 380mm



50844

65,00€

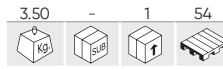

TABURETE DE ACERO



MEDIDAS GENERALES



52148

65,00€

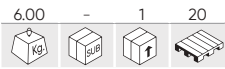

CAMILLA PLÁSTICA



MEDIDAS GENERALES

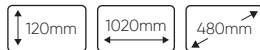

50808

77,00€

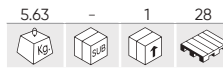

CAMILLA PLEGABLE METÁLICA



MEDIDAS GENERALES

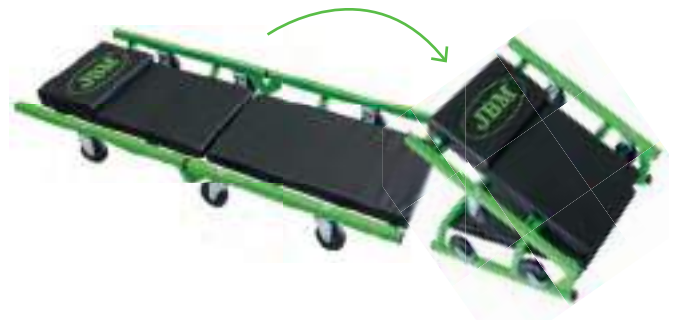

REF.	DESCRIPCIÓN					€
11971	RUEDA PARA CAMILLA PLÁSTICO REF.52148 - GRIS	0.20	5	50	-	3,60€

53211

75,00€

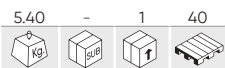

CAMILLA PLEGABLE CONVERTIBLE



MEDIDAS GENERALES



MEDIDAS PLEGADO

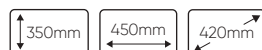

52542

109,00€



CAMILLA PLEGABLE CONVERTIBLE



MEDIDAS GENERALES



MEDIDAS PLEGADO



MOBILIARIO DE TALLER

52869

52,00€



TORNILLO DE BANCO 100MM / 4"



52870

100,00€



TORNILLO DE BANCO 150MM / 6"



53031

59,00€

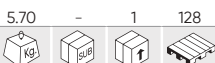

TORNILLO DE BANCO BASE ROTATIVA 100MM / 4"



53032

126,00€



TORNILLO DE BANCO BASE ROTATIVA 150MM / 6"



52871

258,00€

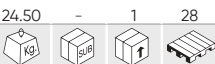

TORNILLO DE BANCO RÁPIDO 150MM / 6"



APERTURA INMEDIATA
MEDIANTE PALANCA +
BASE ROTATIVA



YUNQUES DE ACERO

REF.	Kg.	mm						€
52308	50Kg	190x625x140mm	47.00	-	1	24	440,00€	
52309	100Kg	245x790x180mm	100.00	-	1	8	941,00€	

ACERO



HERRAMIENTAS ELÉCTRICAS A BATERÍA

- 102 ATORNILLAR
- 106 TALADRAR
- 108 LIJAR/PULIR
- 110 SERRAR
- 113 HERRAMIENTAS ESPECIALES
- 118 HERRAMIENTAS PARA JARDINERÍA
- 122 BATERÍAS / CARGADORES
- 123 ACCESORIOS / CONSUMIBLES



**UTILÍZALAS CON LAS BATERÍAS JBM:
UNA ÚNICA BATERÍA APTA PARA TODAS LAS HERRAMIENTAS**

TRES TIPOS DE BATERÍA Y DOS TIPOS DE CARGADOR.
¡ESCOGE EL QUE PREFIERAS!



60046C

339,00€

5,00 - 4 40



N

PISTOLA DE IMPACTO BRUSHLESS A BATERÍA 1/2" 550NM CON MALETÍN

CONTIENE

REF.	DESCRIPCIÓN					€
60013	BATERÍA LI-ION 4.0AH	0.75	-	5	700	80,00€
60016	CARGADOR 20V - 4A	0.80	-	5	210	49,00€
60046	PISTOLA DE IMPACTO BRUSHLESS A BATERÍA 1/2" 550NM	1.50	-	4	200	174,00€

Esta herramienta ha sido diseñada para tensar y aflojar tornillos y tuercas que requieren ejercer un alto par de apriete. Viene equipada con una luz de trabajo LED y un selector del sentido de la rotación que también permite bloquear el gatillo y prevenir un arranque accidental de la herramienta.

Cuenta con 5 marchas distintas, 3 para apretar y 2 para aflojar, permitiendo ajustar la velocidad según la operación que vaya a realizar. Además, gracias a su empuñadura ergonómica se consigue un mayor agarre y precisión.

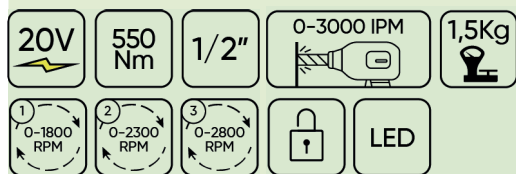

- MOTOR BRUSHLESS
- LUZ DE TRABAJO LED
- SELECTOR DE LA DIRECCIÓN DE ROTACIÓN
- EMPUÑADURA ERGONÓMICA
- 5 MARCHAS DISTINTAS: 3 PARA APRETAR Y 2 PARA AFLOJAR
- GANCHO DE TRANSPORTE

LOS COMPARTIMENTOS DE NUESTROS ESTUCHES SON COMPATIBLES CON LAS BATERÍAS DE 4.0AH Y 6.0AH.



60046

174,00€

1,50 - 4 200



N

PISTOLA DE IMPACTO BRUSHLESS A BATERÍA 1/2" 550NM

BATERÍA NO INCLUIDA



**UTILÍZALAS CON LAS BATERÍAS JBM:
UNA ÚNICA BATERÍA APTA PARA TODAS LAS HERRAMIENTAS**

TRES TIPOS DE BATERÍA Y DOS TIPOS DE CARGADOR.
¡ESCOGE EL QUE PREFIERAS!



60044C

485,00€



PISTOLA DE IMPACTO BRUSHLESS A BATERÍA 1/2" 1300NM CON MALETÍN

CONTIENE

REF.	DESCRIPCIÓN					€
60013	BATERÍA LI-ION 4.0AH	0.75	-	5	700	80,00€
60016	CARGADOR 20V - 4A	0.80	-	5	210	49,00€
60044	PISTOLA DE IMPACTO BRUSHLESS A BATERÍA 1/2" 1300NM	3.25	-	5	90	330,00€

Motor brushless X-TorQ de nueva generación. Permite desatornillar tornillos y tuercas clavadas o muy apretadas ¡Hasta 2 veces más rápido!

Es una herramienta robusta y duradera, con acabados de alta calidad. Tiene una carcasa de aluminio protegida con elastómero en su parte delantera y el peso perfecto para trabajos que requieren vasos de grandes dimensiones y altos niveles de torque. Dispone de 5 modos de trabajo para aflojar tornillos de forma fácil y segura que permiten regular la velocidad de atornillado según requiera el trabajo que se esté realizando. También incluye un microprocesador inteligente que protege la herramienta de sobrecargas y calentamientos a altas temperaturas ambientales. Además, el doble martillo de nuevo diseño proporciona más IPM y menos vibración.

Su nuevo anillo de sujeción del vaso permite al usuario cambiar los vasos más rápido y una sujeción más segura. También dispone de un gancho de gran tamaño, útil para colgar la herramienta en estructuras metálicas o en el mismo cinturón de trabajo, así como una luz LED que permite mejorar la visibilidad en superficies con poca iluminación. Hemos mejorado la eficiencia y los tiempos de funcionamiento. Ahora podrás disfrutar de una mayor duración de la batería que permite la vida útil de la herramienta.

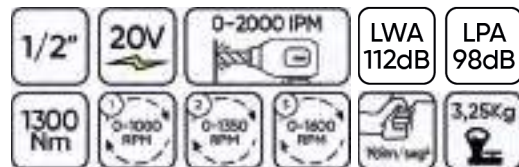

- MOTOR BRUSHLESS
- LUZ DE TRABAJO LED
- SELECTOR DE LA DIRECCIÓN DE ROTACIÓN
- EMPUÑADURA ERGONÓMICA
- 5 MARCHAS DISTINTAS: 3 PARA APRETAR Y 2 PARA AFLOJAR
- GANCHO DE TRANSPORTE

LOS COMPARTIMENTOS DE NUESTROS ESTUCHES SON COMPATIBLES CON LAS BATERÍAS DE 4.0AH Y 6.0AH.



60044

330,00€



PISTOLA DE IMPACTO BRUSHLESS A BATERÍA 1/2" 1300NM

BATERÍA NO INCLUIDA



60048C

560,00€

715	-	4	32

N

PISTOLA DE IMPACTO BRUSHLESS A BATERÍA 3/4" 1300NM CON MALETÍN

CONTIENE

REF.	DESCRIPCIÓN					€
60015	BATERÍA LI-ION 6.0AH	1.00	-	20	630	138,00€
60016	CARGADOR 20V - 4A	0.80	-	5	210	49,00€
60048	PISTOLA DE IMPACTO BRUSHLESS A BATERÍA 3/4" 1300NM	3.26	-	4	64	366,00€

Esta herramienta ha sido diseñada para apretar y aflojar tuercas y tornillos que requieren un par elevado. Está equipado con una luz LED de trabajo y un selector de rotación que también le permite bloquear el gatillo y evitar un arranque accidental de la herramienta.

Dispone de 5 marchas diferentes, 3 para apretar y 2 para aflojar, lo que permite realizar un ajuste de velocidad según la operación a realizar. Además, cuenta con un mango ergonómico para un mejor agarre y precisión.

- MOTOR BRUSHLESS
- LUZ DE TRABAJO LED
- SELECTOR DE LA DIRECCIÓN DE ROTACIÓN
- EMPUÑADURA ERGONÓMICA
- 5 MARCHAS DISTINTAS: 3 PARA APRETAR Y 2 PARA AFLOJAR
- GANCHO DE TRANSPORTE

LOS COMPARTIMENTOS DE NUESTROS ESTUCHES SON COMPATIBLES CON LAS BATERÍAS DE 4.0AH Y 6.0AH.



60048

366,00€

3.26	-	4	64

N

PISTOLA DE IMPACTO BRUSHLESS A BATERÍA 3/4" 1300NM

BATERÍA NO INCLUIDA



DESPIECE DISPONIBLE

60005

132,00€

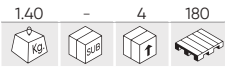

ATORNILLADOR

BATERÍA NO INCLUIDA

Esta herramienta ha sido diseñada para atornillar y apretar tornillos y tuercas de forma rápida, especialmente al trabajar con tornillos pasadores largos y en materiales robustos.

Viene equipada con una luz de trabajo LED para mejorar la precisión durante su uso, un porta puntas hexagonal de 1/4" que permite una inserción y extracción rápida de las puntas.

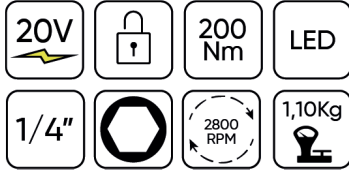

- A MOTOR BRUSHLESS
- B LUZ DE TRABAJO LED
- C SELECTOR DE LA DIRECCIÓN DE ROTACIÓN
- D EMPUÑADURA ERGONÓMICA
- E 5 MARCHAS DISTINTAS: 3 PARA APRETAR Y 2 PARA AFLOJAR
- F GANCHO DE TRANSPORTE
- G BATERÍA NO INCLUIDA



ACCESORIOS Y RECAMBIOS

DESPIECE DISPONIBLE

PÁGINA 126



60024

190,00€

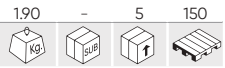

CARRACA DE 1/2" A BATERÍA - 12V

BATERÍA NO INCLUIDA

Esta herramienta está diseñada para apretar y aflojar tornillos en espacios reducidos.

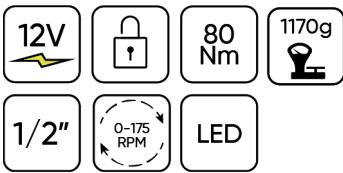

- A LLAVE CUADRADA 1/2"
- B CAMBIO DE DIRECCIÓN: AVANCE / RETROCESO
- C LUZ DE TRABAJO LED INCORPORADA
- D INDICADOR DE NIVEL DE BATERÍA
- E INTERRUPTOR DE BLOQUEO
- F VELOCIDAD VARIABLE
- G PROTECCIÓN DE SOBRECARGA

CONTIENE

REF.	DESCRIPCIÓN					€
60025	CARGADOR 12V - PARA REF. 60026	0.30	5	4	700	31,60€
60026	BATERÍA LI-ION 2.0AH SAMSUNG - PARA REF. 60024	0.20	5	40	1400	37,90€



60023

212,00€



MARTILLO PERCUTOR SDS A BATERÍA

BATERÍA NO INCLUIDA

Diseñada para realizar tareas de cincelado y perforación con impacto en hormigón, ladrillo y madera, así como tareas en otros materiales como acero, metal, cerámica y plástico donde la perforación sin impacto es necesaria.



- A MOTOR BRUSHLESS
- B MEDIDOR DE PROFUNDIDAD
- C CUBIERTA PROTECTORA DEL POLVO
- D PORTABROCAS SDS
- E SELECTOR DEL MODO DE OPERACIÓN
- F BOTÓN DE EXTRACCIÓN DE LA BATERÍA
- G EMPUÑADURA ERGONÓMICA
- H LUZ DE TRABAJO LED
- I BATERÍA NO INCLUIDA



- CONTIENE**
- 1 CUBIERTA ANTIPOLVO
 - 1 MEDIDOR DE PROFUNDIDAD
 - 1 MANGO AUXILIAR
 - 1 CINCEL EN PUNTA
 - 1 CINCEL PLANO
 - 3 BROCAS SDS: 8/10/12 X 150MM



ACCESORIOS Y RECAMBIOS

PÁGINA 123

DESPIECE DISPONIBLE

60006

182,00€



TALADRO PERCUTOR 2 VELOCIDADES A BATERÍA

BATERÍA NO INCLUIDA

Esta herramienta ha sido diseñada para realizar tareas de perforación en metal y madera, tareas de perforación con impacto, en ladrillo, hormigón y piedra, así como para tensar, aflojar y desenroscar tuercas y tornillos.



- A MOTOR BRUSHLESS
- B LUZ DE TRABAJO LED
- C SELECTOR DE LA DIRECCIÓN DE ROTACIÓN
- D EMPUÑADURA ERGONÓMICA
- E GANCHO DE TRANSPORTE
- F BATERÍA NO INCLUIDA



MANGO AUXILIAR



ACCESORIOS Y RECAMBIOS

PÁGINA 124

DESPIECE DISPONIBLE

60047C

318,00€



N

TALADRO PERCUTOR 2 VELOCIDADES A BATERÍA CON MALETÍN

CONTIENE

REF.	DESCRIPCIÓN					€
60013	BATERÍA LI-ION 4.0AH	0.75	-	5	700	80,00€
60016	CARGADOR 20V - 4A	0.80	-	5	210	49,00€

Esta herramienta ha sido diseñada para taladrar agujeros en diferentes tipos de materiales. Puede realizar tareas de perforación en madera y metal, así como tareas de perforación con impacto más comunes en la albañilería, ladrillo, hormigón y piedra.

También puede tensar, aflojar y desenroscar tuercas y tornillos. Para ello dispone de un anillo de ajuste que le permite elegir entre 20 niveles de torque diferentes.

Dispone de un selector de velocidad y un selector para ajustar el sentido de rotación hacia izquierda o derecha. Este selector, situado en su posición central, permite bloquear el gatillo y prevenir un arranque accidental de la herramienta.

Está equipada con una luz LED para mejorar la visión de la zona de trabajo. Lleva un gancho para poder colgar del cinturón y un mango auxiliar para una mejor sujeción.



20V	150 Nm	1/2"	0-35000 BPM
1 0-550 RPM	2 0-2200 RPM	LED	1,62Kg

- MOTOR BRUSHLESS
- LUZ DE TRABAJO LED
- SELECTOR DE LA DIRECCIÓN DE ROTACIÓN
- EMPUÑADURA ERGONÓMICA
- 5 MARCHAS DISTINTAS: 3 PARA APRETAR Y 2 PARA AFLOJAR
- GANCHO DE TRANSPORTE
- MANGO AUXILIAR

LOS COMPARTIMENTOS DE NUESTROS ESTUCHES SON COMPATIBLES CON LAS BATERÍAS DE 4.0AH Y 6.0AH.



ACCESORIOS Y RECAMBIOS

PÁGINA 124

DESPIECE DISPONIBLE



60009

168,00€



PULIDORA A BATERÍA

BATERÍA NO INCLUIDA

Esta herramienta ha sido diseñada para llevar a cabo procesos de acabado, tales como pulir y redondear bordes y esquinas, así como para conseguir un correcto alisado de superficies mediante su rueda y almohadilla de pulido.



- A MOTOR BRUSHLESS
- B SELECTOR DE VELOCIDAD DE 9 FASES:
800, 1000, 1200, 1400, 1600, 1800, 2000, 2200, 2400 RPM
- C INTERRUPTOR DE SEGURIDAD
- D EMPUÑADURA ERGONÓMICA
- E MANGO AUXILIAR EN D
- F CIERRE DE EJE
- G ALMOHADILLA DE PULIDO
- H BATERÍA NO INCLUIDA



LLAVE ALLEN HEXAGONAL



DESPIECE DISPONIBLE



60033

104,00€



LIJADORA ORBITAL A BATERÍA

BATERÍA NO INCLUIDA

Esta herramienta está diseñada para lijar madera, hierro, plástico y materiales similares utilizando el papel de lija adecuado. Esta lijadora es ajustable a tres velocidades diferentes, cuenta con una empuñadura confortable y lleva incorporada una bolsa de recogida de polvo.



- A MOTOR BRUSHLESS
- B BOTÓN DE ENCENDIDO/CONTROL DE VELOCIDAD
- C INTERRUPTOR DE APAGADO
- D BOLSA PARA EL POLVO
- E BASE
- F BATERÍA NO INCLUIDA



DESPIECE DISPONIBLE

60049C

329,00€

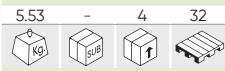

N

AMOLADORA ANGULAR BRUSHLESS 125MM CON MALETÍN

CONTIENE

REF.	DESCRIPCIÓN					€
60013	BATERÍA LI-ION 4.0AH	0.75	-	5	700	80,00€
60016	CARGADOR 20V - 4A	0.80	-	5	210	49,00€

BATERÍA NO INCLUIDA

Esta amoladora angular está diseñada para realizar todo tipo de tareas de corte, pulido y lijado. Incluye una empuñadura frontal con 2 posiciones seleccionables y una cubierta de protección.



CUBIERTA PROTECTORA

MANGO AUXILIAR

BATERÍA NO INCLUIDA

LOS COMPARTIMENTOS DE NUESTROS ESTUCHES SON COMPATIBLES CON LAS BATERÍAS DE 4.0AH Y 6.0AH.

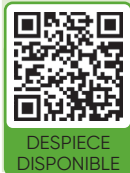

ACCESORIOS Y RECAMBIOS

PÁGINA 127

DESPIECE DISPONIBLE

60028

142,00€



AMOLADORA ANGULAR A BATERÍA 125MM

BATERÍA NO INCLUIDA

Esta amoladora angular está diseñada para realizar todo tipo de tareas de corte, pulido y lijado. Incluye una empuñadura frontal con 2 posiciones seleccionables y una cubierta de protección.



ACCESORIOS Y RECAMBIOS

PÁGINA 127

DESPIECE DISPONIBLE



LLAVE DE AJUSTE

60019

178,00€



SIERRA DE SABLE A BATERÍA

BATERÍA NO INCLUIDA

Diseñada para realizar tareas de corte en un gran variedad de materiales y ser usada para múltiples aplicaciones. Su diseño permite cambiar la hoja de corte de manera rápida y precisa, gracias a su sistema de anclaje sin necesidad de utilizar herramientas, así como adaptar la velocidad de corte dependiendo de la operación que vaya a realizar.



- A MOTOR BRUSHLESS
- B HOJA DE CORTE
- C ZAPATA
- D SISTEMA DE ANCLAJE DE LA HOJA
- E BOTÓN DE BLOQUEO DEL GATILLO
- F EMPUÑADURA ERGONÓMICA
- G BATERÍA NO INCLUIDA



ACCESORIOS Y RECAMBIOS

PÁGINA 128

DESPIECE DISPONIBLE

CONTIENE
HOJA PARA MADERA
HOJA PARA METAL

60020

175,00€



CEPILLO A BATERÍA

BATERÍA NO INCLUIDA

Esta herramienta está diseñada para realizar tareas de carpintería. Se puede utilizar para lograr un acabado liso en superficies de madera y realizar tareas de rebaje. Tiene una base de aleación de aluminio para proporcionar una mayor precisión, un sistema de colección del polvo resultante de la operación, así como un botón de bloqueo del gatillo para evitar un arranque accidental de la herramienta.

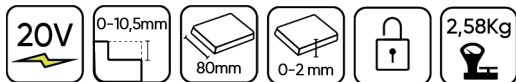

- A MOTOR BRUSHLESS
- B BOTÓN DE BLOQUEO
- C POMO DE AJUSTE DE PROFUNDIDAD DE CORTE
- D GUÍA PARALELA
- E GUÍA DE TOPE DE PROFUNDIDAD DE GALCE
- F PERILLA DE AJUSTE DE LA GUÍA DE PROFUNDIDAD DE GALCE
- G PUERTO DE EXTRACCIÓN DEL POLVO
- H RANURA EN V
- I BATERÍA NO INCLUIDA



CONTIENE
1 PERILLA DE AJUSTE DE LA PROFUNDIDAD DE GALCE
1 GUÍA PARALELA
3 PERILLAS DE FIJACIÓN
1 LLAVE DE AJUSTE
1 TORNILLO

DESPIECE DISPONIBLE

60010

170,00€

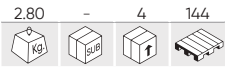

SIERRA DE CALAR A BATERÍA

BATERÍA NO INCLUIDA

Esta herramienta ha sido diseñada para realizar tareas de corte en diferentes materiales, tales como madera, acero, plástico y metal. Cuenta con 4 niveles de acción pendular: 3 acciones de corte orbitales y una acción de corte recto, que permiten ajustar la velocidad de la hoja según la dureza del material a cortar.



- A MOTOR BRUSHLESS
- B PROTECTOR DE LA HOJA
- C CUBIERTA DE ANCLAJE TRANSPARENTE DE LA HOJA
- D HOJA DE SIERRA
- E SELECTOR DE LA ACCIÓN DE CORTE
- F PALANCA DE AJUSTE DE LA BASE
- G BOTÓN DE BLOQUEO DEL GATILLO
- H BATERÍA NO INCLUIDA



CONTIENE
HOJA PARA MADERA
GUÍA DE CORTE
ADAPTADOR PARA EL CONDUCTO DEL POLVO



ACCESORIOS Y RECAMBIOS

PÁGINA 128

DESPIECE DISPONIBLE

60007

170,00€

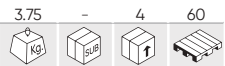

SIERRA CIRCULAR A BATERÍA

BATERÍA NO INCLUIDA

Esta herramienta ha sido diseñada para realizar tareas de corte en madera. La hoja de sierra de 165 mm de diámetro y 24 dientes hace que sea ideal para realizar cortes longitudinales y transversales rectos en paneles y tablones de madera, así como cortes en ángulo de hasta 45°.



- A MOTOR BRUSHLESS
- B PALANCA DEL PROTECTOR INFERIOR
- C BASE
- D PROTECTOR INFERIOR
- E BLOQUEADOR DE ÁNGULO DE CORTE
- F MANGO FRONTAL
- G BOTÓN BLOQUEADOR
- H BATERÍA NO INCLUIDA



CONTIENE
HOJA TCT DE 24 DIENTES DE 165MM
GUÍA DE CORTE
LLAVE HEXAGONAL



ACCESORIOS Y RECAMBIOS

PÁGINA 128

DESPIECE DISPONIBLE

60011

175,00€



MINI SIERRA CIRCULAR A BATERÍA

BATERÍA NO INCLUIDA

Esta herramienta ha sido diseñada para realizar tareas de corte en madera. La hoja de sierra de 115 mm de diámetro y 24 dientes hace que sea ideal para realizar cortes longitudinales y transversales rectos en paneles y tablonos de madera, así como cortes en ángulo de hasta 45°. Cuenta también con un botón de bloqueo del gatillo para prevenir un arranque accidental de la herramienta, y una protección de aluminio.



- A MOTOR BRUSHLESS
- B PROTECTOR INFERIOR
- C PALANCA DEL PROTECTOR INFERIOR
- D BASE
- E PROTECTOR SUPERIOR
- F GUÍA DE CORTE
- G BOTÓN DE BLOQUEO DEL GATILLO
- H BATERÍA NO INCLUIDA



CONTIENE
HOJA DE 115MM 24T TCT
GUÍA DE CORTE
TUBO PARA EL POLVO
LLAVE HEXAGONAL

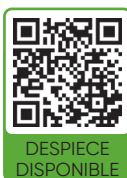

ACCESORIOS Y RECAMBIOS

PÁGINA 128

60022

470,00€

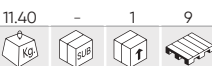

INGLETADORA A BATERÍA

BATERÍA NO INCLUIDA

Viene equipada con una bolsa de extracción para el polvo, una guía láser, una llave de ajuste para la inserción y extracción de la hoja de corte, y una prensa de sujeción de la pieza de trabajo. Además, cuenta con un botón de seguridad para activar el gatillo para prevenir un arranque accidental de la herramienta.



- CONTIENE
- 1 HOJA DE CORTE DE 40 DIENTES
 - 1 ABRAZADERA DE SUJECIÓN
 - 1 LLAVE PARA LA HOJA DE CORTE
 - 1 BOLSA DE EXTRACCIÓN DEL POLVO



ACCESORIOS Y RECAMBIOS

PÁGINA 128



60032

123,00€

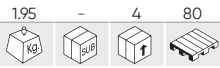

PISTOLA DE SILICONA A BATERÍA

BATERÍA NO INCLUIDA

Esta herramienta está diseñada para sellar cualquier hueco o grieta en una amplia variedad de materiales como metal, vidrio, madera y cerámica.



- A SOPORTE DEL CARTUCHO
- B ÉMBOLO
- C VARILLA DEL ÉMBOLO
- D MANGO DE LA VARILLA DEL ÉMBOLO
- E INTERRUPTOR DE LIBERACIÓN DE LA VARILLA
- F SELECTOR DE VELOCIDAD
- G LUZ LED
- H BATERÍA NO INCLUIDA

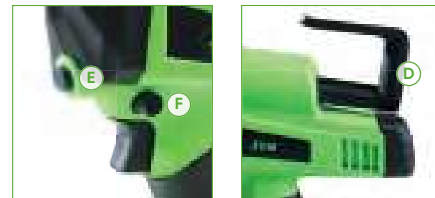

DESPIECE DISPONIBLE

60038

255,00€

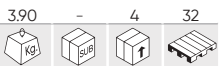

PISTOLA ENGRASADORA A BATERÍA

BATERÍA NO INCLUIDA

Esta herramienta ha sido diseñada para tareas de lubricación. Puede ser fácilmente transportada y manipulada en cualquier lugar gracias a su diseño.



- A RUEDA DE AJUSTE DEL CAUDAL DE GRASA
- B BOTÓN DE BLOQUEO
- C LUZ DE TRABAJO LED
- D MANGUERA FLEXIBLE
- E TUBO DE GRASA
- F VÁLVULA DE PURGA DE SEGURIDAD
- G BATERÍA NO INCLUIDA



DESPIECE DISPONIBLE

60041

77,00€

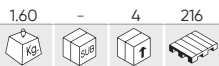

MULTIHERRAMIENTA OSCILANTE

BATERÍA NO INCLUIDA

La multiherramienta eléctrica oscilante le permite acoplar diferentes tipos de accesorios para poder realizar variados trabajos. Es especialmente útil para hacer rascados, lijados y vaciados en espacios estrechos.



- A MOTOR BRUSHLESS
- B PALANCA DE SUJECIÓN
- C SOPORTE DE BLOQUEO
- D SELECTOR DE VELOCIDAD
- E LUZ DE TRABAJO
- F SISTEMA DE SUJECIÓN DE LOS ACCESORIOS
- G BATERÍA NO INCLUIDA



CONTIENE
 HOJA DE SIERRA DE INMERSIÓN
 HOJA DE LIJADO
 PLACA DE LIJADO
 RASCADOR
 ARANDELA
 MANGO

60037

222,00€



CLAVADORA A BATERÍA

BATERÍA NO INCLUIDA

Esta herramienta está diseñada para el clavado y grapado de cartón, material aislante, tela, láminas, cuero y materiales similares en superficies de madera o materiales similares a la madera.



- A LUZ LED
- B PASADOR DE CONTACTO DE SEGURIDAD
- C CARGADOR
- D INDICADOR DE LUZ LED
- E SELECTOR DEL MODO DE DISPARO
- F INTERRUPTOR DE LA LUZ LED
- G BATERÍA NO INCLUIDA



ACCESORIOS Y RECAMBIOS
 PÁGINA 127

GRAPAS DE CORONA ESTRECHA DE CALIBRE 18 DE USO LIGERO

LONGITUD MÁXIMA DE LAS GRAPAS	40 mm
ANCHURA MÁXIMA DE LA SECCIÓN TRANSVERSAL DE LA GRAPA	1.2 mm
GROSOR MÁXIMO DE LA SECCIÓN TRANSVERSAL DE LA GRAPA	1 mm
CORONA MÁXIMA DE LAS GRAPAS	6 mm

CLAVOS BRAD DE CALIBRE 18

LONGITUD MÁXIMA DE LOS CLAVOS	50 mm
ANCHURA MÁXIMA DE LA SECCIÓN TRANSVERSAL DEL CLAVO	1.25 mm
GROSOR MÁXIMO DE LA SECCIÓN TRANSVERSAL DEL CLAVO	1.05 mm

60042

106,00€



PISTOLA DE CALOR A BATERÍA

BATERÍA NO INCLUIDA

La pistola de calor eléctrica se utiliza principalmente para la retracción de PVC, soldadura, curvado de piezas de plástico y secado ordinario, fusión y descongelación.

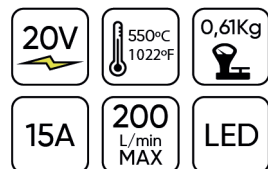

- A CUBIERTA FRONTAL
- B BOQUILLA
- C LUZ LED
- D BLOQUEO DEL INTERRUPTOR DE ENCENDIDO
- E GANCHO DE METAL
- F BATERÍA NO INCLUIDA



60043

123,00€



PULVERIZADOR DE PINTURA A BATERÍA

BATERÍA NO INCLUIDA

Esta herramienta está diseñada para pulverizar pintura en superficies de interior y de exterior.



- A REGULADOR DE CAUDAL
- B TANQUE
- C BLOQUEO DEL TANQUE
- D FILTRO DE AIRE
- E BATERÍA NO INCLUIDA



UTILÍZALAS CON LAS BATERÍAS JBM: UNA ÚNICA BATERÍA APTA PARA TODAS LAS HERRAMIENTAS

TRES TIPOS DE BATERÍA Y DOS TIPOS DE CARGADOR.
¡ESCOGE EL QUE PREFIERAS!

**Baterías y cargadores NO INCLUIDOS en las herramientas.*



60001

88,00€

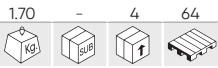

ASPIRADOR PORTÁTIL A BATERÍA

BATERÍA NO INCLUIDA

Este aspirador eléctrico sin cable ha sido diseñado para eliminar y aspirar cualquier resto de polvo u otro material que no sea dañino para la salud.



- A DEPÓSITO DE RECOGIDA DEL POLVO
- B BOTÓN DE APERTURA DEL DEPÓSITO DE RECOGIDA DEL POLVO
- C INTERRUPTOR ENCENDIDO/APAGADO
- D CARCASA/ALOJAMIENTO DEL MOTOR
- E BOQUILLA PARA JUNTAS
- F BOQUILLA CON CEPILLO
- G BOQUILLA PARA SUELOS
- H TUBO DE EXTENSIÓN
- I BATERÍA NO INCLUIDA

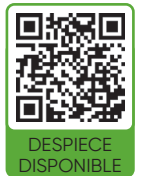

CONTIENE

REF.	DESCRIPCIÓN					€
14950	TUBO DE EXTENSIÓN PARA REF. 60001	0.08	5	10	-	6,50€
14951	BOQUILLA PARA JUNTAS PARA REF. 60001	0.01	-	10	-	9,50€
14952	BOQUILLA PARA SUELOS PARA REF. 60001	0.15	-	5	-	19,00€
14953	BOQUILLA CON CEPILLO PARA REF. 60001	0.05	-	10	-	8,50€

60003

110,00€



COMPRESOR A BATERÍA

BATERÍA NO INCLUIDA

Este inflador le permite inflar ruedas de automóvil y motocicletas, pelotas, lanchas neumáticas, colchones inflables, etc.



- A LUZ LED
- B BOTÓN DE ENCENDIDO DE LA LUZ LED
- C SELECTOR DEL MODO DE TRABAJO
- D BOTONES DE SELECCIÓN DE PRESIÓN
- E CONECTOR USB-CARGADOR
- F MANGUERA DE ALTA PRESIÓN
- G MANGUERA DE ALTA CAPACIDAD
- H CONECTOR PARA TOMA DE MECHERO 12V
- I BATERÍA NO INCLUIDA



CONTIENE



60004

79,00€

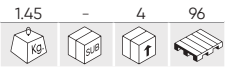

FARO DE TRABAJO LED

BATERÍA NO INCLUIDA

Este faro de trabajo LED ha sido diseñado para garantizar una perfecta iluminación del área de trabajo y cualquier otro lugar. Si la batería se agota, es posible conectar el cable de alimentación provisto en la ranura de la parte trasera del faro y enchufarlo a la toma de corriente de 230V.

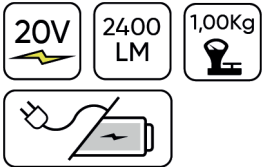

- A INTERRUPTOR ENCENDIDO/APAGADO
- B CABEZAL
- C LENTE DE LUCES LED
- D PERILLA DE BLOQUEO LATERAL
- E CABLE DE ALIMENTACIÓN
- F BATERÍA NO INCLUIDA



REF.	DESCRIPCIÓN					€
15049	TRÍPODE PARA FARO DE TRABAJO LED (REF. 60004)	2.10	-	4	120	37,40€

60035

30,00€



PORTÁTIL DE TRABAJO LED A BATERÍA

BATERÍA NO INCLUIDA

Este faro de trabajo LED ha sido diseñado para garantizar una perfecta iluminación del área de trabajo y cualquier otro lugar. Su funcionamiento con la batería de litio portátil hace que sea ideal para moverlo libremente de un sitio a otro, y en situaciones donde no se tiene acceso al suministro eléctrico.

La lente de luces LED proporciona una potencia de luz que puede ajustarse a 500 y 1000 lúmenes, y el cabezal del faro tiene un ángulo de ajuste de 90° para adaptar la dirección de la luz según convenga. También incluye una empuñadura blanda ergonómica para un mayor control y confort y un gancho para poder colgarlo a cualquier objeto.

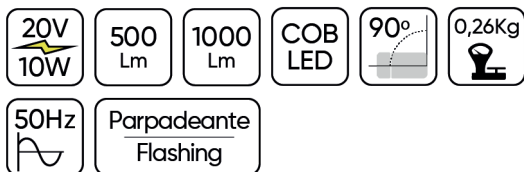

- A LENTE DE LUCES LED
- B CABEZAL ROTATORIO
- C GANCHO
- D INTERRUPTOR ENCENDIDO/APAGADO
- E BATERÍA NO INCLUIDA



60039

265,00€

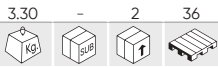

HIDROLIMPIADORA A PRESIÓN A BATERÍA

BATERÍA NO INCLUIDA

La hidrolimpiadora a presión eléctrica brushless está diseñada para limpiar vehículos, equipos, herramientas, muebles de exterior, etc.



- A MOTOR BRUSHLESS
- B BOQUILLA GIRATORIA DE 5 POSICIONES
- C ACOPLAMIENTO DE BOQUILLA DE CONEXIÓN RÁPIDA
- D LANZA
- E INDICADOR DE PRESIÓN
- F INTERRUPTOR DE SELECCIÓN DE PRESIÓN
- G INTERRUPTOR DE BLOQUEO
- H ADAPTADOR DE CONEXIÓN RÁPIDA PARA LA MANGUERA
- I BATERÍA NO INCLUIDA



DESPIECE DISPONIBLE



60027

99,00€

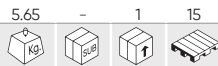

PULVERIZADOR DE MOCHILA 15L A BATERÍA

BATERÍA NO INCLUIDA

Adecuado para la desinfección medioambiental de hogares, lugares públicos, explotaciones ganaderas, jardines, etc., contribuyendo a la erradicación de todo tipo de partículas infecciosas y su divulgación, así como la prevención de plagas y enfermedades. Bomba de diafragma con un interruptor de presión inteligente que puede ser bloqueado para un uso continuo.

Equipada con 4 cabezales diferentes intercambiables para adaptar la potencia y flujo de pulverización según la necesidad requerida: 1 cabezal de cono hueco, 1 cabezal de doble cono hueco, 1 cabezal de 4 salidas, 1 cabezal de aire inducido.

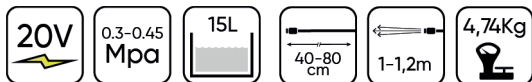

- A MANGO PARA TRANSPORTAR FÁCILMENTE
- B ALMOHADILLA PARA LA ESPALDA
- C TAPA CON UN DISEÑO DE SELLADO A PRUEBA DE FUGAS
- D LANZA TELESCÓPICA EXTENSIBLE
- E BATERÍA NO INCLUIDA

NO ACEPTA BATERÍAS DE 6.0AH

CONTIENE



60029

240,00€

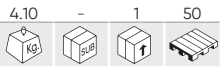

MOTOSIERRA A BATERIA BRUSHLESS

BATERÍA NO INCLUIDA

Esta herramienta ha sido diseñada para realizar tareas forestales en madera tales como la tala de árboles y cortar ramas y troncos, entre otras.

Está equipada con una perilla para ajustar la barra guía y la tensión de la cadena y un protector frontal para frenar la cadena en caso de contragolpe. Además, presenta un sistema de lubricación automático de la cadena y un botón de bloqueo del gatillo para prevenir un arranque accidental de la herramienta. También incluye una barra guía, una cadena y una cubierta para proteger tanto la barra como la cadena para su almacenaje y transporte.



- A MOTOR BRUSHLESS
- B CADENA
- C BARRA GUÍA
- D FRENO DE LA CADENA/PROTECTOR FRONTAL
- E MANGO FRONTAL
- F BOTÓN DE BLOQUEO DEL GATILLO
- G TAPA DEL TANQUE DE COMBUSTIBLE
- H BATERÍA NO INCLUIDA



CONTIENE

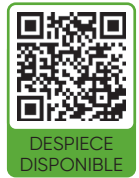

60030

112,00€

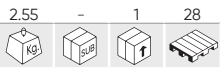

SOPLADOR A BATERÍA

BATERÍA NO INCLUIDA

Esta herramienta ha sido diseñada para barrer hojas, pasto, papel y otros materiales similares. Alimentada con una batería de iones de litio, es ideal para transportarla de un lugar a otro gracias a su diseño sin cables y su peso ligero. Viene equipada con un interruptor para una configuración de alta o baja velocidad de flujo de aire y volumen, y una empuñadura ergonómica para un mayor control y agarre.



- A MOTOR BRUSHLESS
- B TUBO DE SOPLADO
- C OREJETA DEL TUBO DE SOPLADO
- D CARCASA
- E BATERÍA NO INCLUIDA

NO ACEPTA BATERÍAS DE 6.0AH

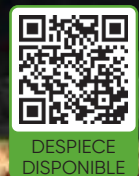

60031

142,00€

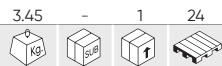

CORTASETOS A BATERÍA

BATERÍA NO INCLUIDA

Esta herramienta está diseñada para realizar tareas de jardinería como recortar, cortar o podar setos o arbustos de forma rápida y cómoda. Alimentada con una batería de iones de litio, es ideal para ser transportada de un sitio a otro gracias a su diseño sin cables y su peso ligero.

Viene equipada con una cubierta para la cuchilla para ayudar a mantener la herramienta en buenas condiciones, una protección para desviar las astillas u otros desechos lejos de las manos y los ojos del usuario, y un mango auxiliar para un mejor control y comodidad. Además, cuenta con dos interruptores y un botón de bloqueo para evitar un arranque accidental de la herramienta.



- A MOTOR BRUSHLESS
- B HOJA DE CORTE
- C BARRA DE SOPORTE DE LA CUCHILLA
- D GUARDA PROTECTORA
- E INTERRUPTOR DEL MANGO AUXILIAR
- F MANGO AUXILIAR
- G BOTÓN DE BLOQUEO
- H EMPUÑADURA TRASERA
- I BATERÍA NO INCLUIDA



CONTIENE
CUBIERTA DE LA CUCHILLA



60040

440,00€



DESBROZADORA 4 EN 1

BATERÍA NO INCLUIDA

La máquina eléctrica multifunción 4 en 1 está diseñada para una multitud de tareas al aire libre, como desbrozar los espacios verdes, arreglar los setos del jardín, cortar ramas, etc. Es un producto ideal para el mantenimiento integral del jardín.

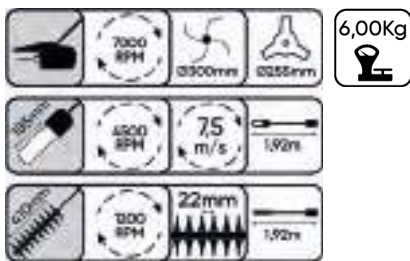

- A MOTOR BRUSHLESS
- B PROTECTOR
- C DISCO DE CORTE DE TRES PUNTAS
- D CUCHILLA
- E SIERRA
- F MANGOS
- G DESBROZADORA
- H CABEZAL PARA HILO DE CORTE
- I CORTA SETOS
- J SIERRA DE PÉRTIGA
- K BATERÍA NO INCLUIDA



52598

1.080,00€

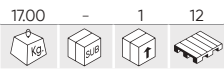

ROBOT CORTACÉSPED

Robot cortacésped moderno y funcional, perfecto para el cuidado y el mantenimiento de tu césped y de espacios verdes. Está equipado con un motor sin escobillas, alimentado por una potente batería de 5200 Ah, para una autonomía de 150 minutos aproximadamente. El plato de corte con tres cuchillas de acero que realizarán un corte mulching. Con este corte, la hierba depositada en el césped se descompondrá y se convertirá en nutriente para el suelo, creando un ciclo biológico totalmente natural. El cable perimetral y las estacas suministradas permiten una instalación sencilla y sin necesidad de herramientas.



CONEXIÓN APP



- A MOTOR BRUSHLESS
- B INTERRUPTOR STOP
- C ESTACIÓN DE CARGA
- D RUEDA TRASERA
- E TAPA DEL CONTROL

60045

298,00€

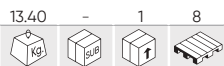

CORTACESPED DE BATERÍA

BATERÍA NO INCLUIDA

Este cortador de césped a batería le permite mantener el césped de su jardín en perfecto estado. Está equipado con un motor brushless gracias al cual se consigue una mayor eficacia y menos nivel de ruido. Además, es muy ligero y fácil de maniobrar.



- A MOTOR BRUSHLESS
- B CORTACÉSPED
- C MANGO
- D BOLSA RECOGEDORA DE CÉSPED

FUNCIONA CON 2 BATERÍAS 4AH (NO INCLUIDAS)



UTILÍZALAS CON LAS BATERÍAS JBM: UNA ÚNICA BATERÍA APTA PARA TODAS LAS HERRAMIENTAS

TRES TIPOS DE BATERÍA Y DOS TIPOS DE CARGADOR.
¡ESCOGE EL QUE PREFIERAS!

**Baterías y cargadores NO INCLUIDOS en las herramientas.*



BATERÍAS LI-ION



INDICADORES DE CARGA LED



SISTEMA PROTECTOR DE CORTOCIRCUITOS



SISTEMA PROTECTOR DE SOBRECALENTAMIENTO



SISTEMA PROTECTOR DE SOBRECARGAS



60012



48,00€



60013



80,00€



60015



138,00€



PARA REF. 60024

60026



37,90€



CARGADORES

100V
240V

50-60
Hz



INDICADORES DE CARGA LED



SISTEMA PROTECTOR DE CORTOCIRCUITOS



SISTEMA PROTECTOR DE SOBRECALENTAMIENTO



SISTEMA PROTECTOR DE SOBRECARGAS



60016



49,00€

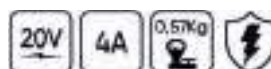

CARGA RÁPIDA

60017



64,00€

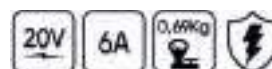

PARA REF. 60026

60025



31,60€

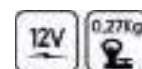

ACCESORIOS PARA EXPOSITORES



REF.	DESCRIPCIÓN	mm						€
14622	BANDEJA SOPORTE PARA REF.60001, 60003, 60004, 60020	320x180	A	0.95	-	10	360	17,00€
14623	GANCHO PARA REF.60005, 60006, 60018	70x84	B	0.10	-	10	800	8,00€
14624	BANDEJA SOPORTE PARA REF.60007, 60010, 60011	290x160	C	0.65	-	10	300	17,00€
14625	SOPORTE PARA REF.60008, 60009	40x200x100	D	0.50	-	10	700	14,00€
14626	GANCHO PARA REF.60023	115x70	E	0.10	-	10	-	7,00€
16364	GANCHO DE PUNTA LARGO 280MM	280		0.20	-	200	-	3,50€



RECAMBIOS



CINCELES SDS-PLUS

REF.	DESCRIPCIÓN				€
14837	CINCEL EN PUNTA SDS PLUS 14X250MM	0.25	10	100	3,30€
14838	CINCEL PLANO SDS PLUS 20X250MM	0.25	10	100	3,40€
14839	CINCEL PLANO SDS PLUS 40X250MM	0.29	10	50	4,70€
14840	CINCEL ACANALADO SDS PLUS 250MM	0.27	10	50	3,35€



53850 14,90€

0,65	5	25	1000

ESTUCHE DE BROCAS SDS PLUS PARA TALADRO PERCUTOR



DESPIECE DISPONIBLE

REF.	mm				€
14826	Ø 5x110mm	0.05	125	500	1,50€
14828	Ø 6x110mm	0.05	25	500	1,50€
14829	Ø 6x160mm	0.04	25	500	1,50€
14830	Ø 8x110mm	0.04	25	500	1,50€
14831	Ø 8x160mm	0.05	25	500	1,50€
14832	Ø 10x160mm	0.05	25	200	2,00€
14920	Ø 12x160mm	0.10	100	200	2,50€

TAMBIÉN TE PUEDE INTERESAR...

REF.	mm				€
14825	Ø 4x110mm	0.05	100	200	1,50€
14827	Ø 5x160mm	0.04	25	500	2,00€
14833	Ø 10x210mm	0.10	20	200	2,05€
14834	Ø 12x210mm	0.10	100	200	2,50€
14835	Ø 14x210mm	0.10	20	125	3,00€
14836	Ø 16x210mm	0.14	20	120	3,50€



HERRAMIENTAS ELÉCTRICAS A BATERÍA

14841

2,58€

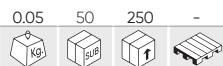

ADAPTADOR SDS PLUS 1/2" PARA PORTABROCAS



14842

9,50€

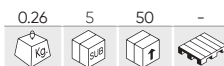

PORTABROCAS DE ROSCA 2-13MM DE 1/2"-20UNF



60006
60047C

53860

3,65€

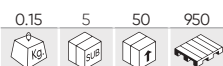

ESTUCHES DE BROCAS 4-10MM PARA ALBAÑILERÍA



DESPIECE DISPONIBLE

REF.	mm				€
14908	Ø 4x75mm	0.01	50	100	0,60€
14909	Ø 5x80mm	0.01	50	100	0,80€
14910	Ø 6x100mm	0.01	50	100	1,00€
14912	Ø 8x120mm	0.05	50	100	1,55€
14914	Ø 10x120mm	0.04	20	100	2,10€

TAMBIÉN TE PUEDE INTERESAR...

REF.	mm				€
14915	Ø 11x150mm	0.05	20	100	2,65€
14916	Ø 12x150mm	0.06	20	100	2,95€
14917	Ø 13x150mm	0.10	20	100	3,45€



53861

5,45€



ESTUCHES DE BROCAS 3-10MM PARA ALBAÑILERÍA



DESPIECE DISPONIBLE

REF.	mm				€
14907	Ø 3x60mm	0.01	50	100	0,50€
14908	Ø 4x75mm	0.01	50	100	0,60€
14909	Ø 5x80mm	0.01	50	100	0,80€
14910	Ø 6x100mm	0.01	50	100	1,00€
14911	Ø 7x100mm	0.01	50	100	1,30€
14912	Ø 8x120mm	0.05	50	100	1,55€
14913	Ø 9x120mm	0.05	50	100	1,90€
14914	Ø 10x120mm	0.04	20	100	2,10€



53859

67,00€



ESTUCHE DE SIERRAS DE CORONA BIMETÁLICAS CON ADAPTADORES



	x6	22, 29, 35, 44, 51, 68mm
	x2	14-30mm, 32-152mm



DESPIECE DISPONIBLE

REF.	mm				€
14901	22mm	0.04	10	50	3,60€
14902	29mm	0.08	10	50	4,65€
14903	35mm	0.10	10	50	5,25€
14904	44mm	0.12	10	50	6,85€
14905	51mm	0.12	10	50	8,50€
14906	68mm	0.19	10	50	10,20€
14934	14-30mm	0.07	10	50	4,25€
14935	32-152mm	0.20	10	50	8,45€

ESTUCHE DE BROCAS HELICOIDALES HSS-G 4341

53852 207,00€

4.20 - 4 192

170 PCS HSS-G 4341

METAL 1-10 mm



53856 62,00€

1.32 5 10 550

25 PCS HSS-G 4341

METAL 1-13 mm



53854 27,00€

0.63 5 20 192

19 PCS HSS-G 4341

METAL 1-10 mm



DESPIECE DISPONIBLE

REF.	mm				€
14868	Ø 1x34mm	0.01	50	400	0,55€
14869	Ø 1.5x40mm	0.01	50	400	0,60€
14870	Ø 2x49mm	0.01	50	400	1,00€
14871	Ø 2.5x57mm	0.01	50	400	1,00€
14872	Ø 3x61mm	0.01	50	400	1,00€
14873	Ø 3.5x70mm	0.01	50	400	1,00€
14874	Ø 4x75mm	0.01	50	400	1,00€
14875	Ø 4.5x80mm	0.01	50	400	1,50€
14876	Ø 5x86mm	0.01	50	300	1,50€
14877	Ø 5.5x93mm	0.02	50	300	1,50€
14878	Ø 6x93mm	0.02	25	400	2,00€
14879	Ø 6.5x101mm	0.02	25	400	2,00€
14880	Ø 7x109mm	0.03	25	400	2,50€
14881	Ø 7.5x109mm	0.03	25	400	2,50€
14882	Ø 8x117mm	0.04	25	400	3,00€
14883	Ø 8.5x117mm	0.04	25	400	3,50€
14884	Ø 9x125mm	0.05	25	400	3,65€
14885	Ø 9.5x125mm	0.05	25	400	4,00€
14886	Ø 10x133mm	0.06	25	400	4,60€
14887	Ø 10.5x133mm	0.07	25	400	5,00€
14888	Ø 11x142mm	0.08	25	400	6,00€
14889	Ø 11.5x142mm	0.09	25	400	6,50€
14890	Ø 12x151mm	0.10	25	300	7,00€
14891	Ø 12.5x151mm	0.09	25	200	7,50€
14892	Ø 13x151mm	0.09	25	200	8,00€

1x34, 1.5x40, 2x49, 2.5x57, 3x61, 3.5x70, 4x75, 4.5x80, 5x86, 5.5x93, 6x93, 6.5x101, 7x109, 7.5x109, 8x117, 8.5x117, 9x125, 9.5x125, 10x133mm

1x34, 1.5x40, 2x49, 2.5x57, 3x61, 3.5x70, 4x75, 4.5x80, 5x86, 5.5x93, 6x93, 6.5x101, 7x109, 7.5x109, 8x117, 8.5x117, 9x125, 9.5x125, 10x133, 10.5x133, 11x142, 11.5x142, 12x151, 12.5x151, 13x151mm

1x34, 1.5x40, 2x49, 2.5x57, 3x61, 3.5x70, 4x75, 4.5x80, 5x86, 5.5x93, 6x93, 6.5x101, 7x109, 7.5x109, 8x117, 8.5x117, 9x125, 9.5x125, 10x133mm

ESTUCHE DE BROCAS HELICOIDALES HSS-R 4241 (NEGRO)

53851 88,00€

3.80 - 4 192

170 PCS HSS-G 4241

METAL 1-10 mm



53855 24,80€

1.19 5 10 192

25 PCS HSS-G 4241

METAL 1-13 mm



53853 14,40€

0.58 5 20 192

19 PCS HSS-G 4241

METAL 1-10 mm



DESPIECE DISPONIBLE

REF.	mm				€
14843	Ø 1x34mm	0.01	50	400	0,50€
14844	Ø 1.5x40mm	0.01	50	400	0,50€
14845	Ø 2x49mm	0.01	50	400	0,50€
14846	Ø 2.5x57mm	0.01	50	400	0,50€
14847	Ø 3x61mm	0.01	50	400	0,50€
14848	Ø 3.5x70mm	0.01	50	400	0,50€
14849	Ø 4x75mm	0.01	50	400	1,00€
14850	Ø 4.5x80mm	0.01	50	400	1,00€
14851	Ø 5x86mm	0.01	50	300	1,00€
14852	Ø 5.5x93mm	0.01	50	300	1,00€
14853	Ø 6x93mm	0.02	25	400	1,00€
14854	Ø 6.5x101mm	0.02	25	400	1,00€
14855	Ø 7x109mm	0.02	25	400	1,00€
14856	Ø 7.5x109mm	0.03	25	400	1,00€
14857	Ø 8x117mm	0.03	25	400	1,50€
14858	Ø 8.5x117mm	0.04	25	400	1,50€
14859	Ø 9x125mm	0.04	25	400	1,50€
14860	Ø 9.5x125mm	0.05	25	400	2,00€
14861	Ø 10x133mm	0.05	25	400	2,00€
14862	Ø 10.5x133mm	0.06	25	400	2,00€
14863	Ø 11x142mm	0.07	25	400	2,50€
14864	Ø 11.5x142mm	0.07	25	400	2,50€
14865	Ø 12x151mm	0.08	25	300	2,50€
14866	Ø 12.5x151mm	0.09	25	200	3,00€
14867	Ø 13x151mm	0.09	25	200	3,00€

1x34, 1.5x40, 2x49, 2.5x57, 3x61, 3.5x70, 4x75, 4.5x80, 5x86, 5.5x93, 6x93, 6.5x101, 7x109, 7.5x109, 8x117, 8.5x117, 9x125, 9.5x125, 10x133mm

1x34, 1.5x40, 2x49, 2.5x57, 3x61, 3.5x70, 4x75, 4.5x80, 5x86, 5.5x93, 6x93, 6.5x101, 7x109, 7.5x109, 8x117, 8.5x117, 9x125, 9.5x125, 10x133, 10.5x133, 11x142, 11.5x142, 12x151, 12.5x151, 13x151mm

1x34, 1.5x40, 2x49, 2.5x57, 3x61, 3.5x70, 4x75, 4.5x80, 5x86, 5.5x93, 6x93, 6.5x101, 7x109, 7.5x109, 8x117, 8.5x117, 9x125, 9.5x125, 10x133mm

ESTUCHE DE BROCAS HELICOIDALES HSS-CO5 COBALTO

N

54348 291,00€

4.20	2	4	160

170 PCS **HSS CO5**

METAL **1-10 mm**

54314 82,00€

1.32	5	10	14663

25 PCS **HSS CO5**

METAL **1-13 mm**

54313 43,00€

0.60	5	10	-

19 PCS **HSS CO5**

METAL **1-10 mm**

DESPIECE DISPONIBLE

REF.	mm					€
16318	Ø 1x34mm	0.50	25	400	0,50€	
16319	Ø 1.5x40mm	0.50	25	400	0,50€	
16320	Ø 2x49mm	0.50	25	400	0,50€	
16321	Ø 2.5x57mm	0.50	25	400	1,00€	
16322	Ø 3x61mm	0.50	25	400	1,00€	
16323	Ø 3.5x70mm	0.50	25	400	1,00€	
16324	Ø 4x75mm	0.05	25	400	1,50€	
16325	Ø 4.5x80mm	0.50	25	400	1,50€	
16326	Ø 5x86mm	0.50	25	400	2,00€	
16327	Ø 5.5x93mm	0.50	25	400	2,00€	
16328	Ø 6x93mm	0.50	25	400	2,50€	
16329	Ø 6.5x101mm	0.50	25	400	3,00€	
16330	Ø 7x109mm	0.50	25	400	3,50€	
16331	Ø 7.5x109mm	0.50	25	400	3,50€	
16332	Ø 8x117mm	0.50	25	400	4,00€	
16333	Ø 8.5x117mm	0.05	5	200	4,50€	
16334	Ø 9x125mm	0.50	25	200	5,50€	
16335	Ø 9.5x125mm	0.50	25	200	6,00€	
16336	Ø 10x133mm	0.50	25	200	6,50€	
16583	Ø 10.5x133mm	0.07	25	200	8,50€	
16584	Ø 11x142mm	0.07	25	200	10,50€	
16585	Ø 11.5x142mm	0.08	25	200	11,50€	
16586	Ø 12x151mm	0.10	25	200	13,00€	
16587	Ø 12.5x151mm	0.10	25	200	14,00€	
16588	Ø 13x151mm	0.11	25	200	15,00€	



1x34, 1.5x40, 2x49, 2.5x57, 3x61, 3.5x70, 4x75, 4.5x80, 5x86, 5.5x93, 6x93, 6.5x101, 7x109, 7.5x109, 8x117, 8.5x117, 9x125, 9.5x125, 10x133mm

1x34, 1.5x40, 2x49, 2.5x57, 3x61, 3.5x70, 4x75, 4.5x80, 5x86, 5.5x93, 6x93, 6.5x101, 7x109, 7.5x109, 8x117, 8.5x117, 9x125, 9.5x125, 10x133, 10.5x133, 11x142, 11.5x142, 12x151, 12.5x151, 13x151mm

1x34, 1.5x40, 2x49, 2.5x57, 3x61, 3.5x70, 4x75, 4.5x80, 5x86, 5.5x93, 6x93, 6.5x101, 7x109, 7.5x109, 8x117, 8.5x117, 9x125, 9.5x125, 10x133mm

53857 27,00€

0.40	6	24	1152

ESTUCHE DE PUNTAS DE IMPACTO CON ADAPTADOR RÁPIDO S2 - ACABADO NEGRO

57 PCS **S2**



EN EXPOSITOR DE 6 UNIDADES



CONTIENE

	x9	PH	25mm	1x3, 2x3, 3x3
	x9	PZ	25mm	1x3, 2x3, 3x3
	x4	H	25mm	3, 4, 5, 6
	x6	SL	25mm	4x2, 5x2, 6x2
	x14	TX	25mm	10x2, 15x2, 20x2, 25x2, 27x2, 30x2, 40x2
	x7	T	25mm	10, 15, 20, 25, 27, 30, 40
	x7		65mm	PH2, PH3, PZ1, PZ2, T20, T25, SL6
	x1		60mm	

* TAMBIÉN COMPATIBLE CON REF. 60005

53858 28,80€

0.55	6	24	672

ESTUCHE DE PUNTAS DE IMPACTO CON ADAPTADORES S2 - ACABADO NEGRO

33 PCS **S2**



EN EXPOSITOR DE 6 UNIDADES



CONTIENE

	x4	PH	25mm	1, 2x2, 3
	x3	PZ	25mm	1, 2, 3
	x4	H	25mm	3, 4, 5, 6
	x4	SL	25mm	3, 4, 5, 6
	x6	TX	25mm	10, 15, 20, 25, 30, 40
	x6		75mm	T15, T20, T25, PH2, PZ2, SL5
	x4		48mm	6, 7, 8, 10mm
	x1		60mm	
	x1		80mm	

* TAMBIÉN COMPATIBLE CON REF. 60005

54346

11,50€

0.30	6	36	144

N

JUEGO DE 3 CEPILLOS DE LIMPIEZA PARA TALADRO

3 PCS PP 1/4"

- A Ø 88mm
- B Ø 100mm
- C Ø 50mm



60037

SET DE CLAVOS BRAD DE CALIBRE 18

REF.	mm				€
53999	25x1,25mm	0.20	-	50	2,00€
54000	30x1,25mm	0.25	-	50	2,50€
54002	38x1,25mm	0.30	-	50	3,00€

1000 PCS

SET DE GRAPAS DE CALIBRE 18

REF.	mm				€
54008	25x6mm	0.45	-	40	3,50€
54010	32x6mm	0.55	-	40	4,50€
54011	38x6mm	0.65	-	40	5,00€

1000 PCS



60028
60049C

15014

20,00€

0.10	50	100	-

M14 115-230 mm

TUERCA DE SUJECIÓN RÁPIDA M14 PARA AMOLADORA ANGULAR



HERRAMIENTAS ELÉCTRICAS A BATERÍA

PARA METAL

REF.	PARA	DESCRIPCIÓN					€
14893	60008	T42 - 115x2,5mm	0.05	50	100	-	2,00€
14894	60028	T42 - 125x2,5mm	0.05	50	200	-	1,20€
14895	60008	T27 - 115x6mm	0.15	25	100	-	1,90€
14896	60028	T27 - 125x6mm	0.78	25	100	-	2,10€

PARA ACERO INOXIDABLE

REF.	PARA	DESCRIPCIÓN					€
14897	60008	T41 - 115x1mm	0.01	50	400	-	0,88€
14898	60028	T41 - 125x1mm	0.03	50	400	-	0,98€
14899	60008	T41 - 115x1,6mm	0.03	50	400	-	0,88€
14900	60028	T41 - 125x1,6mm	0.04	50	400	-	0,98€



14893



14894



14897



14898



14895



14896



14899



14900



60007
60010
60011
60019
60022

PARA METAL (ACERO INOXIDABLE, ALUMINIO, COBRE)

REF.	PARA	DESCRIPCIÓN					€
14988	60007	24T 165mm	0.25	20	40	2400	8,00€
14989	60011	24T 115mm	0.10	20	100	3600	6,00€
14990	60022	40T 185mm	0.30	20	40	2200	10,50€
14993	60010	T118A	0.05	20	200	7200	5,00€
14995	60019	150mm 24TPI	0.05	20	200	8400	8,00€

PARA MADERA

REF.	PARA	DESCRIPCIÓN					€
14985	60007	24T 165mm	0.25	20	40	2400	6,00€
14986	60011	24T 115mm	0.10	20	100	3600	4,00€
14987	60022	40T 185mm	0.30	20	40	2200	8,50€
14991	60010	T244D	0.05	20	200	7200	2,00€
14994	60019	150mm 6TPI	0.05	20	200	8400	3,50€



14989



14988



14990



14955



14994



14991



14993



14986



14985



14987



ILUMINACIÓN

- 130 PORTÁTILES DE TALLER
- 132 FRONTALES
- 134 LINTERNAS
- 135 FOCOS
- 136 ILUMINACIÓN DE CAPÓ
- 137 GIROFAROS
- 139 FAROS DE TRABAJO
- 142 SEÑALIZACIÓN
- 144 ACCESORIOS Y RECAMBIOS

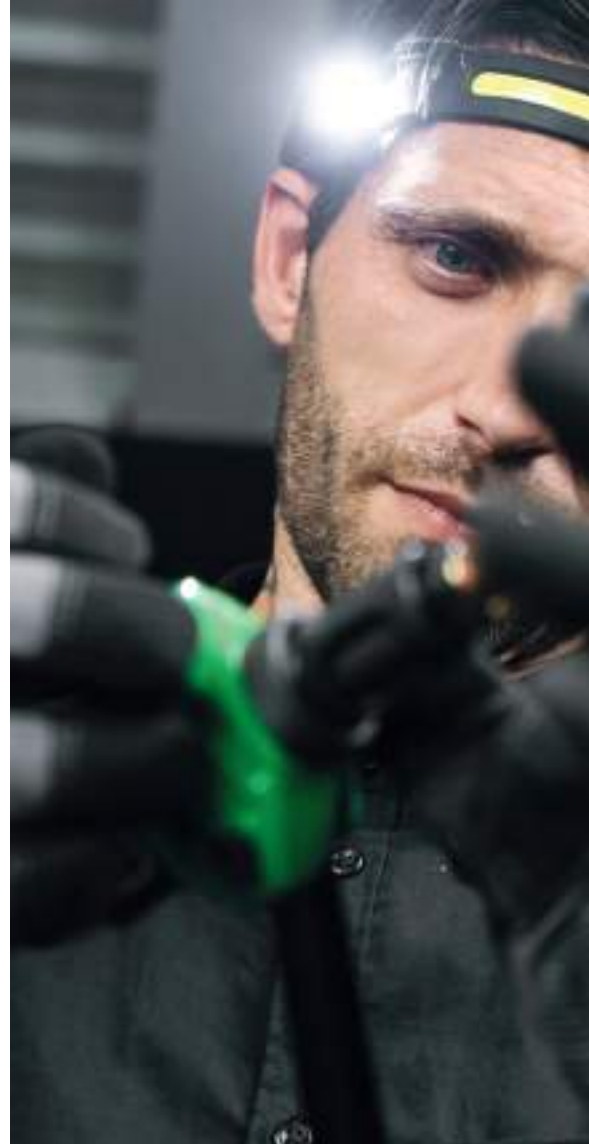

53734

23,70€

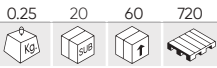

PORTÁTIL DE TALLER COB 400LM



BASE ROTATIVA 360° IMANTADA



SELECTOR DE INTENSIDAD DE LUZ



CARGADOR USB



CON COLGADOR



LI-ION 3.7V 2.600mah



EN EXPOSITOR DE 20 UNIDADES



53519

42,00€

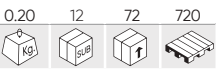

PORTÁTIL DE TALLER COB EXTRAFINO



EN EXPOSITOR DE 12 UNIDADES



52536

57,00€

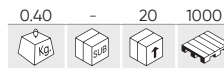

LÁMPARA PORTÁTIL SLIM LED COB CON BATERÍA RECARGABLE



DISEÑO REGISTRADO REGISTERED DESIGN



51889

49,00€

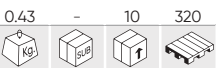

PORTÁTIL DE TALLER 24+6 LEDS CON BATERÍA RECARGABLE / CON DOBLE IMÁN, CUÑA DE APOYO Y BASE IMANTADA



53216

49,00€

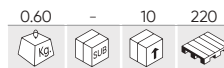

LÁMPARA PORTÁTIL COB PLEGABLE CON BASE GIRATORIA IMANTADA ARTICULADA



PORTÁTIL DE TALLER CON BASE IMANTADA ARTICULADA

54122 38,00€

0.39 12 24 384

300 Lm	3-4H	LED	COB
3W - 7H	3W - 2,5H	LITHIUM	6500± 400
3.7V 2.000mA	KELVIN	IP 44	68-71 ICR
100V 240V	5V 1A		

54123 40,00€

0.39 12 24 384

500 Lm	6-7H	LED	COB
3W - 14H	5W - 3H	LITHIUM	6500± 400
3.7V 4.000mA	KELVIN	IP 44	68-71 ICR
100V 240V	5V 1A		

54124 47,00€

0.39 12 24 384

1000 Lm	6-8H	LED	COB
3W - 14H	10W - 3H	LITHIUM	6500± 400
3.7V 4.000mA	KELVIN	IP 44	68-71 ICR
100V 240V	5V 1A		



EN EXPOSITOR DE 12 UNIDADES

REF. DESCRIPCIÓN

14031 ADAPTADOR USB PARA ENCHUFE DE PARED

0.10 10 100 1152 € 7,90€

54379 28,00€

0.23 12 48 1440

140mm 73mm 20mm

N

FARO DE TRABAJO COB RECARGABLE CON ENERGÍA SOLAR

80-800 Lm	5,2V	0,5W	
3,5H	4-12H	BANDA DE ENERGÍA POWER BANK	
800Lm 5W COB	800Lm 10W COB		
x1 LI-POLI 3.7V - 4000mAh			

MODOS DE LUZ



EN EXPOSITOR DE 12 UNIDADES



53776 19,10€

0.15 12 48 1872

150mm 40mm 23mm

LÁMPARA DE BOLSILLO CON BATERÍA

90 Lm	300 Lm	2,5H	
300Lm 5W COB - 3H	LI-ION 3.7V 1500mah		
250Lm 3W COB - 3,5H	ABS TPR		
90Lm 3W LED - 6H			



EN EXPOSITOR DE 12 UNIDADES



250LM 3W COB

300LM 5W COB

90LM 3W LED



54344

10,50€

0,10	10	100	1200

GORRO CON LINTERNA

120 Lm	60 Lm	25 Lm
LM 120 40mm	50 6-8h	25 8-15h
3.7V 250mAh	2H	
LUZ DISPERSA SCATTERED LIGHT	1W	

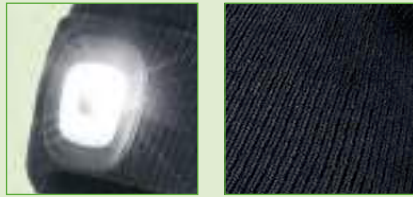

LUZ LED EXTRAÍBLE

POLIÉSTER (65%)
ACRILICO (35%)



N

52987

20,00€

0,17	10	40	720

LÁMPARA DE BOLSILLO CON BATERÍA

120 Lm	2,5H
120Lm - 2,5H	
LITHIUM 3.7V 1.000mA	LED 3W COB



EN EXPOSITOR
DE 10 UNIDADES



160mm	30mm	20mm
-------	------	------



53780

14,50€

0,45	5	20	300

LÁMPARA LED DE TALLER 400LM

400 Lm	6W	220V 240V
IP 20	50 Hz	
6000± 7000 KELVIN		
HOSRN-F 2x0.75mm ² - 5m		

CABLE DE
ALIMENTACIÓN
DE 2,5M



52384

29,00€

0,33	-	20	600

PORTÁTIL EXTRAPLANO CON LED COB

- Longitud del cable: 5m
- DC Longitud del cable: 0,1m
- DC longitud del cable de la pinza: 0,3m

200 Lm	12V 24V
LED 3W COB	
75mm	325mm
	90mm



53217

47,00€

0,30	-	20	620

LÁMPARA PORTÁTIL COB FLEXIBLE CON BASE IMANTADA

200 Lm	4H	LED 2W COB		LITHIUM 3.7V 2.200mah	LITHIUM 5V 1.000mah
--------	----	---------------	--	--------------------------	------------------------



45mm	380mm
------	-------

54004

16,00€



PORTÁTIL DE LUZ FRONTAL COB

COB 330Lm - 5W COB	LED 90Lm - 5W 87E
COB 350Lm - 2,5H 150Lm - 5 H Flash - 8 H	LED XPE 150Lm - 4H 60Lm - 8 H
LI-ION 3.7V 1200mA	Gel de sílice Silice gel



BOTÓN SENSOR DE MOVIMIENTO

Pulsar para activar
Pulsar para desactivar
Pasar la mano por delante del botón para encender y apagar la luz

- Material: Gel de sílice
- Indicador de encendido
- Indicador de inducción
- Modo de activación por sensor de movimiento
- Cable de carga USB incluido



EN EXPOSITOR DE 12 UNIDADES

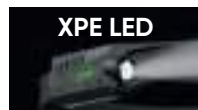

53569

18,00€



PORTÁTIL DE LUZ FRONTAL CREE + COB 800LM

REGULADOR DE ENFOQUE
3 MODOS DE LUZ
BATERÍAS RECARGABLES
INDICADOR DE LUZ ENCENDIDA



MAX 800 Lm	2,5H	150m
LED COB + CREE	x2 18650	
High Low Flash CCB		



53568

12,00€



PORTÁTIL DE LUZ FRONTAL 350LM

REGULADOR DE ENFOQUE
3 MODOS DE LUZ

MAX 350 Lm	2,5H	150m
High Low Flash SOS		
LI-ION 2000mAh		



54267

9,50€

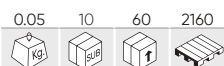

GUANTE CON LUZ LED

70 Lm	120 mAh	+20H
LED	DRAGON LIGHT	
x2 CR2016 INCLUIDO / INCLUDED		
x2 LED 3.0V		



ILUMINACIÓN

53974

38,00€

0.75 5 20 240

FARO DE TRABAJO RECARGABLE

1500 Lm
 5-6H 100% 50%
 LED 20W COB ABS
 100% SOS 50% FLASH

4 MODOS DE LUZ

100% 50% SOS FLASH



MULTIPOSICIÓN



37mm 240mm 225mm

52555

2,38€

0.03 48 192 3456

LINTERNA PLÁSTICA 9 LEDS



27 Lm x9 LED 13 AAA EN EXPOSITOR DE 12 UNIDADES
 30mm 93mm

52558

2,38€

0.03 48 192 3072

51326

4,40€

0.07 12 144 2880

LINTERNA DE 21 LEDS



63 Lm x21 LED 13 AAA EN EXPOSITOR DE 12 UNIDADES
 95mm 35mm

PILAS DE RECAMBIO

REF.	DESCRIPCIÓN					€
51258	"AAA" R03 1,5V	0.01	60	2400	134400	0,15€

PARA REF. 51326, 52233, 52555, 52558

REF.	DESCRIPCIÓN					€
10923	9V	0.05	10	500	-	1,10€

PARA REF. 52162, 52450, 51929, 50942



53427

5,00€

0.05 12 96 3456

MINI LINTERNA IMANTADA 6 LEDS



EN EXPOSITOR DE 12 UNIDADES

45 Lm x6 LED 13 AAA



51573

2,50€

0.07 12 96 3168

LINTERNA DE DINAMO DE 2 LEDS



PRESENTACIÓN EN CAJA INDIVIDUAL

6 Lm x2 LED



53227

28,00€

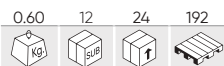

LUPA LED DE MESA



53085

30,00€



LUPA 8 LEDS

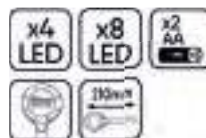

TRÍPODE PARA FOCO LED

REF.	Max.	Min.	KG	SUB	€
53506	1830mm	840mm	2.40	- 8	36,00€
52254	2770mm	1290mm	3.51	- 4	64,00€



53505

77,00€



FOCO LED DE 50W



54039

154,00€

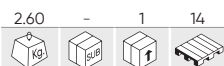

LÁMPARA LED INDUSTRIAL



54133

547,00€



CONJUNTO DE 6 LÁMPARAS LED INDUSTRIALES 54039

6 PCS



REF. DESCRIPCIÓN

15385 CAMPANA PARA REF.54039



54088

132,00€



LÁMPARA LED UFO INDUSTRIAL



ILUMINACIÓN

54270

42,00€

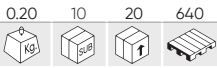

BARRA LED IMANTADA

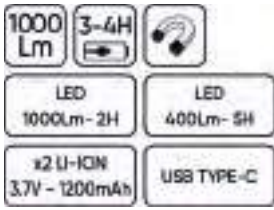

54271

54,00€

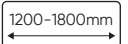
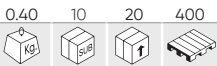

BARRA LED IMANTADA CON CINTA PARA CAPO



ARTICULADA

53707

153,00€

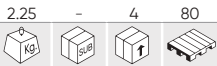

BARRA LED IMANTADA

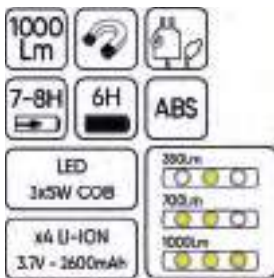

3 MODOS DE LUZ
 BATERÍA RECARGABLE
 LUCES INDICADORAS DEL ESTADO DE LA BATERÍA

AUMENTAN NOTABLEMENTE LA VISIBILIDAD EN LA ZONA DE TRABAJO
 PERMITE DIRIGIR EL FOCO DE LUZ INDIVIDUALMENTE DONDE SE PRECISE
 CON SOPORTE MAGNÉTICO PARA ADAPTARSE A CUALQUIER SITUACIÓN



53570

154,00€

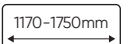

BARRA LED PARA CAPO

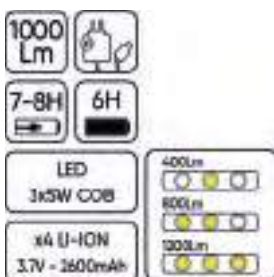

3 MODOS DE LUZ
 BATERÍA RECARGABLE
 LUCES INDICADORAS DEL ESTADO DE LA BATERÍA

AUMENTAN NOTABLEMENTE LA VISIBILIDAD EN LA ZONA DE TRABAJO
 PERMITE DIRIGIR EL FOCO DE LUZ INDIVIDUALMENTE DONDE SE PRECISE



54173 87,00€

0.75 5 20 240

GIROFARO LED RECARGABLE IMANTADO

RECARGABLE

- FUNCIONES:
 FUNCIÓN 1: DESTELLO
 FUNCIÓN 2: DOBLE DESTELLO
 FUNCIÓN 3: ROTACIÓN



20W 5V x45 LED
 PC ABS 2-3H 2-3H
 LI-ION 74V - 2200mA -30°C 50°C IP 65

REF.	DESCRIPCIÓN				€
16053	CABLE USB TIPO A / CLAVIJA REDONDA 5.5MM PARA 54173	0.05	10	100	2,85€

54172 81,00€

0.80 5 20 240

GIROFARO LED RECARGABLE BASE FLEXIBLE

RECARGABLE

- FUNCIONES:
 FUNCIÓN 1: DESTELLO
 FUNCIÓN 2: DOBLE DESTELLO
 FUNCIÓN 3: ROTACIÓN



20W 5V x45 LED
 PC ABS 2-3H 2-3H
 LI-ION 74V - 2200mA -30°C 50°C IP 65

REF.	DESCRIPCIÓN				€
16052	CABLE USB TIPO A / CLAVIJA REDONDA 3.5MM PARA 54172	0.05	10	100	2,09€

53691 36,00€

0.70 - 20 320

GIROFARO LED MAGNÉTICO

- FUNCIONES:
 FUNCIÓN 1: DESTELLO
 FUNCIÓN 2: DOBLE DESTELLO
 FUNCIÓN 3: ROTACIÓN



x8 LED 18W 12V 24V IP 66
 102mm 125cm -30°C 50°C
 4m PC ECE R10 ECE R65

53690 34,00€

0.55 - 20 200

GIROFARO LED 12-24V BASE FLEXIBLE

- FUNCIONES:
 FUNCIÓN 1: DESTELLO
 FUNCIÓN 2: DOBLE DESTELLO
 FUNCIÓN 3: ROTACIÓN



x8 LED 18W 12V 24V IP 66
 102mm 125cm -30°C 50°C
 PC ECE R10 ECE R65

52375 38,00€

0.70 - 20 240

GIROFARO DESTELLANTE DE LED 12-24V

- LENTE ABS-BAES.
 - TULIPA ANTI-ROTURA.
 - CABLE: ESPIRAL DE 2,5M + TOMA MECHERO.
 - CONSUMO: 9W.

- FUNCIONES:
 FUNCIÓN 1: ROTACIÓN
 FUNCIÓN 2: DOBLE DESTELLO
 FUNCIÓN 3: 6 DESTELLOS



12V 24V 9W
 102mm 140cm IP 56
 2.5m PC-ABS ECE R10

BASE MAGNÉTICA

52456 36,00€

0.60 - 20 160

GIROFARO LED 12-24V BASE FLEXIBLE

- LENTE PC.
 - TULIPA ANTI-ROTURA.
 - CONSUMO: 8W.

- FUNCIONES:
 FUNCIÓN 1: ROTACIÓN
 FUNCIÓN 2: DOBLE DESTELLO
 FUNCIÓN 3: 6 DESTELLOS



12V 24V 8W PC-ABS
 240mm 128cm IP 56
 ECE R10

ABS - BAES
 BASE FLEXIBLE

ILUMINACIÓN

51964

28,00€

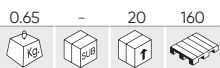

GIROFARO BASE FLEXIBLE H1 12V 55W



Tulipas antirotura
Lente: PC
Hilo de la lente con sellado duradero
RPM : 40
Sistema de piñón / Sinfin
Bombilla H1, 12V 55W
Con base de rosca
Consumo de corriente : 3.0 Amp



ABS - BAES
BASE FLEXIBLE

51965

29,50€



GIROFARO BASE FLEXIBLE H1 24V 70W



Tulipas antirotura
Lente: PC
Hilo de la lente con sellado duradero
RPM : 40
Sistema de piñón / Sinfin
Bombilla H1, 24V 70W
Con base de rosca
Consumo de corriente : 3.0 Amp



ABS - BAES
BASE FLEXIBLE

51962

25,00€



GIROFARO SIN CABLE H1 12V 55W



Tulipas antirotura
Lente ABS - BAES
Hilo de la lente con sellado duradero
RPM : 40
Sistema de piñón / Sinfin
Bombilla H1, 12V 55W
Consumo de corriente : 3.0 Amp



51963

29,00€



GIROFARO SIN CABLE H1 24V 70W



Tulipas antirotura
Lente ABS - BAES
Hilo de la lente con sellado duradero
RPM : 40
Sistema de piñón / Sinfin
Bombilla H1, 24V 70W
Consumo de corriente : 3.0 Amp



51960

34,00€



GIROFARO CON CABLE IMANTADO H1 12V-55W



Tulipas anti-rotura
Lente ABS - BAES
Hilo de la lente con sellado duradero
RPM : 40
Sistema de piñón / Sinfin
Bombilla H1, 12V 55W
Cable: Espiral de 4m con toma de mechero
Consumo corriente : 3.0 Amp



51961

34,00€



GIROFARO CON CABLE IMANTADO H1 24V 70W



Tulipas anti-rotura
Lente ABS - BAES
Hilo de la lente con sellado duradero
RPM : 40
Sistema de piñón / Sinfin
Bombilla H1, 24V 70W
Cable: Espiral de 4m con toma de mechero
Consumo corriente : 3.0 Amp



GIROFARO DESTELLANTE ROTATIVO PERFIL BAJO

REF.						€
52827		0.50	-	20	400	46,00€
52828		0.54	-	20	320	43,00€
52910		0.50	-	20	320	39,00€

- CON 3 INTERRUPTORES DE FUNCIÓN.
- 3 MODOS INTERMITENTES:
ROTATIVO
6 DESTELLOS
MODO DUAL FLASH



51966

18,00€

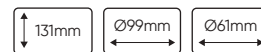
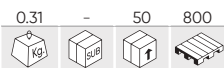

FARO DESTELLANTE 12-110V



- XÉNON.
- Lente ABS - BAES.
- Consumo corriente: 3.0 A.



BASE TULIPA ROSCADA

ACCESORIOS

REF.	DESCRIPCIÓN					€
11103	LÁMPARA DE RECAMBIO PARA REF. 51966	0.01	-	100	-	6,00€
10766	LÁMPARA DE RECAMBIO PARA REF.51960/51962	0.01	-	200	-	1,59€
10750	CONECTOR DE ASTA PARA GIROFARO REF. 51964, 51965, 52456	0.25	-	50	-	13,00€
10751	CONECTOR DE ASTA CON PATAS PARA GIROFARO REF. 51964, 51965, 52300, 52456, 52549 Y 53131	0.30	-	50	-	15,00€
52843	BARRA EXTENSIBLE PARA GIROFARO	0.90	-	20	1500	31,60€
51969	CAPARAZÓN DE GIROFARO NARANJA (P/REF. 51960, 51961, 51964)	0.12	-	50	1000	14,00€
11324	CAPARAZÓN DE GIROFARO AZUL (P/REF. 51960, 51961, 51964)	0.13	-	100	-	17,50€
11325	CAPARAZÓN DE GIROFARO ROJO (P/REF. 51960, 51961, 51964)	0.12	-	50	451	17,50€



FARO DE TRABAJO LED LUZ DISPERSA

53428

18,00€

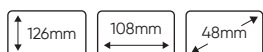
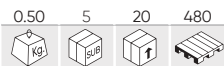

53429

18,00€

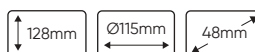
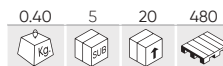

ILUMINACIÓN

52566

28,00€

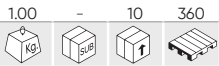

52567

29,00€

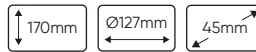
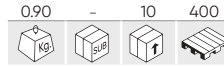

52302

25,40€

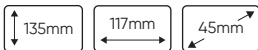
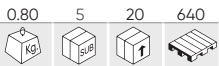

52303

26,40€

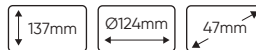
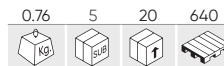

53049

89,00€

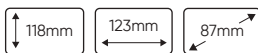
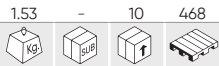

53052

158,00€

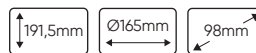
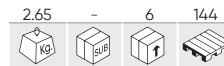

53045

35,00€

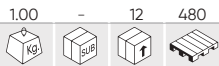

53046

39,00€

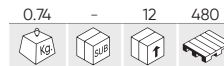

FARO DE TRABAJO LED LUZ CONCENTRADA

52568

28,00€

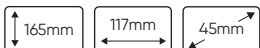
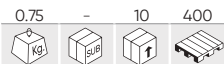

52569

28,00€

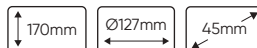
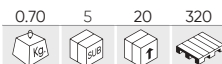

53048

89,00€

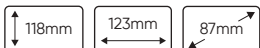

53051

158,00€

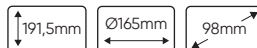

52415

19,00€

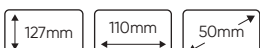

52414

19,00€

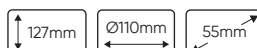

53047

330,00€

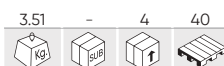

GIRATORIO

VELOCIDAD AJUSTABLE DE MOVIMIENTO

DISTANCIA REMOTA 100M



ILUMINACIÓN

54161

90,00€



BARRA TELESCÓPICA PARA REMOLQUE CON 2 PILOTOS LED Y 2 CATAREFLECTANTES

LUCE DINÁMICAS



REGLAMENTO Nº	Nº DE HOMOLOGACIÓN
3	E9*3R02/17*23444*00
4	E9*4R00/19*23444*00
6	E9*6R01/29*23444*00
7	E9*7R02/27*23444*00
10	E9*10R06/00*22232*02



54163

80,00€



BARRA PARA REMOLQUE CON 2 PILOTOS LED Y 2 CATAREFLECTANTES

LUCE DINÁMICAS



REGLAMENTO Nº	Nº DE HOMOLOGACIÓN
3	E9*3R02/17*23444*00
4	E9*4R00/19*23444*00
6	E9*6R01/29*23444*00
7	E9*7R02/27*23444*00
10	E9*10R06/00*22232*02



50910

45,00€



BARRA PARA REMOLQUE DE 1100X140MM CON 2 PILOTOS, 2 CATAREFLECTANTES TRIANGULARES



REGLAMENTO Nº	Nº DE HOMOLOGACIÓN
4	E4*4R-0024080
6	E4*6R-0124080
7	E4*7R-0224080
10	E9*10R06/02*23498*00



52838

56,00€

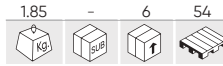

BARRA PARA REMOLQUE 2 PILOTOS LED 1100X140MM



Nº DE HOMOLOGACIÓN
E4*7R-0218756

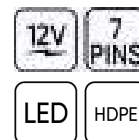

KIT MAGNÉTICO DE 2 PILOTOS LED Y 2 CATAREFLECTANTES

CABLE LISO: 7,5M
CABLE DE ESPIRAL: 2,5M

54162

81,00€

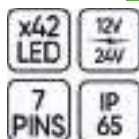

Nº DE HOMOLOGACIÓN
E9*7R02/27*23444*00

LUCE DINÁMICAS



51886

44,00€



REGLAMENTO Nº	Nº DE HOMOLOGACIÓN
3	E4*3R-023749
4	E4*4R-0024080
6	E4*6R-0124080
7	E4*7R-0224080
10	E9*10R06/02*23498*00

52839

64,00€



REGLAMENTO Nº	Nº DE HOMOLOGACIÓN
3	E4*3R-0218756
4	E4*4R-0018756
6	E4*6R-0118756
7	E4*7R-0218756
10	E9*10R06/02*23199*01

54044 99,00€

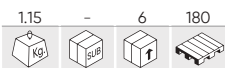

KIT MAGNÉTICO 2 PILOTOS LED INALÁMBRICOS



Nº DE HOMOLOGACIÓN

E9*10R05/01*16210*02

53151 14,00€



PILOTO LED PARA BARRA DE REMOLQUE



- 4 funciones:
- Azul: Posición y matrícula.
- Rojo: Luz de freno.
- Amarillo: Intermitente.
- Blanco: Masa.

PILOTO LED IMANTADO PARA BARRA DE REMOLQUE

REF.					€
54160L	IZQUIERDO	0.20	5	20	17,50€
54160R	DERECHO	0.20	5	20	17,50€

- 4 funciones:
- Negro: Posición y matrícula.
- Rojo: Luz de freno.
- Verde: Intermitente.
- Blanco: Masa.

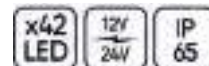

Nº DE HOMOLOGACIÓN

E9*7R02/27*23444*00

E9*10R06/01*23199*00

LUCES DINÁMICAS



53536 34,00€

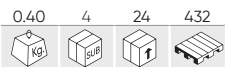

COMPROBADOR DE LUCES DE REMOLQUE 7/13 PINS



REF. DESCRIPCIÓN

REF.	DESCRIPCIÓN				€
14753	ALARGADOR 7 PINS PARA REF. 53536	0.20	-	50	13,00€

51929 22,00€

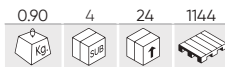

COMPROBADOR DE LUCES DE REMOLQUE 7 PINS



TOMA REMOLQUE

TOMA VEHÍCULO

ILUMINACIÓN

AVISADOR ACÚSTICO 12V - 80V

REF.	DB	IP	V	°C				€
51967	97DB	IP65	12V-80V	-30/70°C	0.20	50	1200	16,00€
51968	107DB	IP65	12V-80V	-30/70°C	0.23	50	1000	16,00€



- Resistente a distintas condiciones climáticas.
- Posibilidad de lavarlo con agua a presión.
- Protegido frente a polaridades inversas.
- Sellado con resinas epoxi.



54078



68,00€



LUZ DE SEGURIDAD PARA CARRETILLA ELEVADORA



Luz oval de seguridad con 2 leds azules. Se proyecta sobre el terreno con una luz concentrada azul a modo de advertencia para los peatones de la zona.

Esta luz de alerta permite evitar colisiones y accidentes entre carretillas elevadoras y personas, y aumenta la seguridad en el entorno de trabajo, especialmente en puntos ciegos. Perfecto para ambientes ruidosos.



TOMAS DE MECHERO Y TRANSFORMADORES

REF.	DESCRIPCIÓN					€
10961	TRANSFORMADOR DE CORRIENTE PARA REF. 51889, 52536	0.08	-	50	-	13,00€
11107	TOMA MECHERO PARA REF. 51889	0.06	-	250	-	4,50€
11989	TOMA MECHERO PARA PORTÁTILES SLIM CON REF. 52536	0.04	-	200	-	2,00€
13839	ADAPTADOR DE ENCHUFE USB 110V/60HZ	0.04	-	200	-	8,50€
14031	ADAPTADOR USB PARA ENCHUFE DE PARED	0.10	10	100	1152	7,90€
14032	ADAPTADOR USB PARA TOMA DE MECHERO	0.10	10	100	1200	12,00€
14033	CABLE USB TIPO A / MICRO-B	0.10	10	100	500	4,50€
16052	CABLE USB TIPO A / CLAVIJA REDONDA 3.5MM PARA 54172	0.05	10	100	-	2,09€
16053	CABLE USB TIPO A / CLAVIJA REDONDA 5.5MM PARA 54173	0.05	10	100	-	2,85€



HERRAMIENTAS NEUMÁTICAS

- 147 ATORNILLAR
- 151 TALADRAR
- 152 CORTAR/SERRAR
- 153 LIJAR/PULIR
- 156 PISTOLAS DE AIRE
- 158 MANTENIMIENTO DE NEUMÁTICOS
- 160 OTROS
- 163 CARRETES/MANGUERAS
- 165 CONECTORES
- 166 ACCESORIOS Y CONSUMIBLES



JBM RECOMIENDA EL USO DE SUS ACEITES LUBRICANTES PARA OPTIMIZAR EL RENDIMIENTO Y ALARGAR LA VIDA ÚTIL DE LA HERRAMIENTA

REF.14534 REF.14560

PÁGINA 161

53520

228,00€

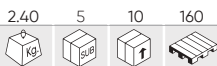

PISTOLA DE IMPACTO 1/2" (1756NM) - COMPOSITE



COMPOSITE
1756Nm



REF.	DESCRIPCIÓN	Kg	SUB	€
14121	SET DE REPARACIÓN HERRAMIENTA NEUMÁTICA - 51207 / 53520	0.75	- 20	26,00€

51207

289,00€



ESTUCHE DE PISTOLA DE IMPACTO DE 1/2" COMPOSITE + VASOS



COMPOSITE
1756Nm



REF.	DESCRIPCIÓN	Kg	SUB	€
14121	SET DE REPARACIÓN HERRAMIENTA NEUMÁTICA - 51207 / 53520	0.75	- 20	26,00€

51206

228,00€

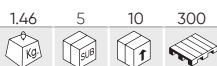

PISTOLA DE IMPACTO 1/2" MINI COMPOSITE



COMPOSITE
1302Nm



REF.	DESCRIPCIÓN	Kg	SUB	€
14120	SET DE REPARACIÓN HERRAMIENTA NEUMÁTICA - 51206	0.15	- 5	22,00€

53588

178,00€



PISTOLA DE IMPACTO NANO 1/2" - 1302NM



1302Nm



REF.	DESCRIPCIÓN	Kg	SUB	€
14165	SET DE REPARACIÓN HERRAMIENTA NEUMÁTICA - 53588	0.05	- 20	26,50€

JBM RECOMIENDA EL USO DE SUS ACEITES LUBRICANTES PARA OPTIMIZAR EL RENDIMIENTO Y ALARGAR LA VIDA ÚTIL DE LA HERRAMIENTA

REF.14534 REF.14560

PÁGINA 161



53733 238,00€

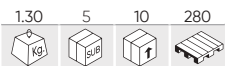

PISTOLA DE IMPACTO ANGULAR 1/2"



650Nm



REF.	DESCRIPCIÓN	kg	L	cm	mm	€
14633	SET DE REPARACIÓN HERRAMIENTA NEUMÁTICA - 53733	0.03	-	20		22,50€

54340 296,00€



N

PISTOLA DE IMPACTO ARTICULADA 1/2"



813 Nm



REF.	DESCRIPCIÓN	kg	L	cm	mm	€
16341	SET DE REPARACIÓN HERRAMIENTA NEUMÁTICA - 54340	0.07	-	15		32,50€

54397 249,00€



N

PISTOLA DE IMPACTO COMPACTA DE 1/2"



1004Nm

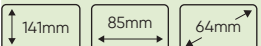

REF.	DESCRIPCIÓN	kg	L	cm	mm	€
16564	SET DE REPARACIÓN HERRAMIENTA NEUMÁTICA - 54397	0.10	-	20		17,00€

53689 238,00€



PISTOLA DE IMPACTO 1/2" 1950NM - COMPOSITE



COMPOSITE 1950Nm



REF.	DESCRIPCIÓN	kg	L	cm	mm	€
14618	SET DE REPARACIÓN HERRAMIENTA NEUMÁTICA - 53689	0.01	-	20		19,00€

HERRAMIENTAS NEUMÁTICAS

53608

98,00€

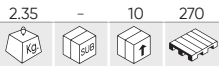

PISTOLA DE IMPACTO 1/2" 1200NM

1200Nm



REF.	DESCRIPCIÓN	kg	sub	un	€
14583	SET DE REPARACIÓN HERRAMIENTA NEUMÁTICA - 53608	0.01	-	20	6,00€

53726

128,00€

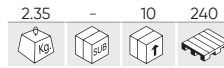

PISTOLA DE IMPACTO 1/2" 1650NM

1650Nm



REF.	DESCRIPCIÓN	kg	sub	un	€
15564	SET DE REPARACIÓN HERRAMIENTA NEUMÁTICA - 53726	0.05	-	-	11,90€

51212

488,00€

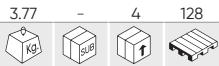

PISTOLA DE IMPACTO 3/4" COMPOSITE

2034Nm

COMPOSITE



REF.	DESCRIPCIÓN	kg	sub	un	€
14122	SET DE REPARACIÓN HERRAMIENTA NEUMÁTICA - 51210 / 51212	1.12	-	50	34,00€

51211

560,00€

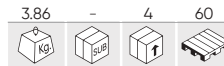

PISTOLA DE IMPACTO 1" COMPOSITE

2034Nm

COMPOSITE



REF.	DESCRIPCIÓN	kg	sub	un	€
14123	SET DE REPARACIÓN HERRAMIENTA NEUMÁTICA - 51211 / 51213	1.16	-	20	33,00€

51210

650,00€

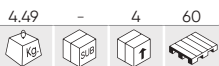

PISTOLA IMPACTO 3/4" + EXTENSOR 15CM COMPOSITE

2034Nm

COMPOSITE



REF.	DESCRIPCIÓN	kg	sub	un	€
14122	SET DE REPARACIÓN HERRAMIENTA NEUMÁTICA - 51210 / 51212	1.12	-	50	34,00€

51213

690,00€



PISTOLA IMPACTO 1" + EXTENSOR 19 CM COMPOSITE

2034Nm

COMPOSITE



REF.	DESCRIPCIÓN	kg	sub	un	€
14123	SET DE REPARACIÓN HERRAMIENTA NEUMÁTICA - 51211 / 51213	1.16	-	20	33,00€

53681

743,00€



PISTOLA DE IMPACTO PARA CAMIONES 1" ULTRALIGERA



2441Nm



REF.	DESCRIPCIÓN				€
14336	SET DE REPARACIÓN HERRAMIENTA NEUMÁTICA - 53681	1.17	10	10	58,00€

52814

528,00€



PISTOLA DE IMPACTO PARA CAMIONES 1" 3260NM



3260Nm



REF.	DESCRIPCIÓN				€
14153	SET DE REPARACIÓN HERRAMIENTA NEUMÁTICA - 52814	0.05	-	15	20,50€

53343

285,00€



PISTOLA DE IMPACTO 3/4"

1600Nm



51222

128,00€



PISTOLA IMPACTO 1/2" DOBLE BLISTER

101Nm



REF.	DESCRIPCIÓN				€
14131	SET DE REPARACIÓN HERRAMIENTA NEUMÁTICA - 51222	0.01	-	10	24,00€

52156

140,00€



ESTUCHE DE 16 PIEZAS NEUMÁTICAS CON PISTOLA Y CARRACA IMPACTO

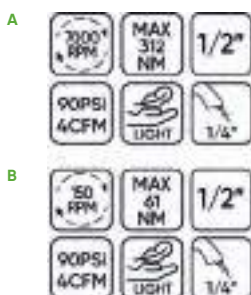

x10 9, 10, 11, 13, 14, 17, 19, 22, 24, 27mm

52165

118,00€



PISTOLA DE IMPACTO DE 1/2"

680Nm



54336

259,00€



N

CARRACA NEUMÁTICA ARTICULADA DE 1/2"

95Nm



REF. DESCRIPCIÓN



16273 SET DE REPARACIÓN HERRAMIENTA NEUMÁTICA - 54336

0.15 - 15 12,50€

51214

148,00€

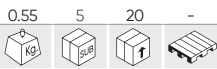

CARRACA MINI DE 1/4" COMPOSITE

40,7Nm

COMPOSITE



REF. DESCRIPCIÓN



14124 SET DE REPARACIÓN HERRAMIENTA NEUMÁTICA - 51214 0.25 - 10 20,50€

51215

119,00€

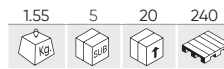

CARRACA DE 1/2"

14-68Nm



REF. DESCRIPCIÓN



14125 SET DE REPARACIÓN HERRAMIENTA NEUMÁTICA - 51215 0.03 - 10 19,50€

52167

48,00€

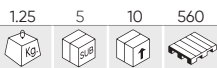

CARRACA NEUMÁTICA DE 1/2"

61Nm



53784

148,00€

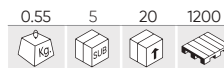

CARRACA NEUMÁTICA MINI DE 1/2" COMPOSITE

40,8Nm

COMPOSITE



REF. DESCRIPCIÓN



14779 SET DE REPARACIÓN HERRAMIENTA NEUMÁTICA - 53784 0.05 - 10 33,00€

51221 199,00€



TALADRO EN ÁNGULO 90°



REF.	DESCRIPCIÓN	kg	SUB	€
14130	SET DE REPARACIÓN HERRAMIENTA NEUMÁTICA - 51221	0.40	- 10	21,00€

51220 240,00€



TALADRO REVERSIBLE COMPOSITE

COMPOSITE



REF.	DESCRIPCIÓN	kg	SUB	€
14129	SET DE REPARACIÓN HERRAMIENTA NEUMÁTICA - 51220	0.01	- 10	12,50€

53573 36,00€



TALADRO NEUMÁTICO RECTO DE 3/8"



52159 64,00€



TALADRO REVERSIBLE NEUMÁTICO DE 1/2"



52527 82,00€



TALADRO REVERSIBLE NEUMÁTICO 3/8" EN ÁNGULO DE 90°



52160 48,00€



TALADRO REVERSIBLE NEUMÁTICO DE 3/8"



TALADRO NEUMÁTICO PARA SOLDADURAS CON DESPLAZAMIENTO DE LA BROCA CENTRAL

52724 381,00€



REF.	DESCRIPCIÓN	kg	SUB	€
13817	BROCA DE 6,5MM PARA TALADRO (REF. 52725 Y 52724)	0.10	- 500	17,00€

52725 349,00€



REF.	DESCRIPCIÓN	kg	SUB	€
13818	BROCA DE 8MM PARA TALADRO (REF. 52725 Y 52724)	0.10	- 500	20,50€

52718

48,00€

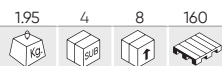

MARTILLO NEUMÁTICO 9PCS



- A 21mm
- B 1,8mm
- C 21mm
- D 21mm



52953

38,00€

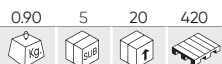

CORTADORA NEUMÁTICA DE 3"



REF.	DESCRIPCIÓN	Kg	SUB	QTY	€
12987	RECAMBIO DISCO PARA REF. 52953	0.02	50	500	1,50€

53140

98,00€



CORTADORA NEUMÁTICA



REF.	DESCRIPCIÓN	Kg	SUB	QTY	€
14013	RECAMBIO DISCO PARA REF. 53140	0.01	-	1000	3,50€

53541

168,00€

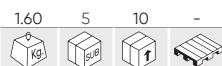

CIZALLA NEUMÁTICA



REF.	DESCRIPCIÓN	Kg	SUB	QTY	€
14136	SET DE REPARACIÓN HERRAMIENTA NEUMÁTICA - 53541	0.01	-	5	12,00€

52574

69,00€



SIERRA NEUMÁTICA



REF.	DESCRIPCIÓN	Kg	SUB	QTY	€
11956	SET DE 5 HOJAS DE SIERRA CON 24 DIENTES PARA MADERA	0.03	10	300	5,50€
11957	SET DE 5 HOJAS DE SIERRA CON 32 DIENTES PARA HIERRO	0.01	10	250	5,50€

51216

650,00€

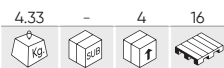

KIT PULIDORA



ACCESORIOS

REF.	DESCRIPCIÓN				€
51388	CEPILLO DE 23MM PARA REF. 51216	0.10	100	800	22,00€
51389	CEPILLO DE 11MM PARA REF. 51216	0.05	1	800	22,00€
51390	CEPILLO FINO PLANO DE 23MM PARA REF. 51216	0.05	100	800	22,00€
51391	CEPILLO FINO DE 11MM PARA REF. 51216	0.04	1	800	22,00€
51392	CEPILLO RASCADOR DE PINTURA PARA 51216	0.20	100	800	34,00€
51393	CEPILLO RASCADOR DE PINTURA AL AGUA PARA 51216	0.10	50	800	34,00€
51439	ADAPTADOR PARA REF. 51216 PARA RUEDA DE 23MM	0.10	100	800	26,00€
51440	ADAPTADOR PARA REF. 51216 PARA RUEDA DE 11MM	0.10	1	800	28,00€
51441	ADAPTADOR PARA REF. 51216 PARA RUEDA NEGRA DOBLE	0.10	1	800	26,00€
51442	ADAPTADOR PARA REF. 51216 PARA RUEDA NEGRA SIMPLE	0.10	50	800	28,00€

REF.	DESCRIPCIÓN				€
14126	SET DE REPARACIÓN HERRAMIENTA NEUMÁTICA - 51216	0.01	-	10	54,00€

CONTIENE

Tipo de Ruedas (Para la preparación de superficies metálicas)
 11mm Cepillo de Alambre (Fino)
 23mm Cepillo de Alambre (Fino)
 11mm Cepillo de Alambre (grueso)
 23mm Cepillo de Alambre (grueso)
 Borrador de goma
 Borrador de Pinturas con base de agua
 Adaptador de 23mm para Borrador de goma y cepillo de alambre
 Adaptador de 11mm cepillo de alambre
 Pulidor Negro de Caucho (hasta 6 piezas)
 Adaptador único de Pulidor caucho
 Adaptador de doble tira de caucho

53576

189,00€



KIT MINI PULIDORA NEUMÁTICA 3"



REF.	DESCRIPCIÓN				€
A	14162 ESPONJA DE LANA PARA REF. 53576	0.05	-	50	25,50€
B	14163 ESPONJA BLANDA PARA 53576 - BLANCA	0.50	5	50	25,50€
C	14164 ESPONJA SÓLIDA PARA REF. 53576 - AMARILLA	0.50	5	50	25,50€
D	14330 DISCO DE VELCRO PARA REF. 53576	0.01	5	50	3,50€
	14154 SET DE REPARACIÓN PARA REF. 53576	0.05	-	10	42,00€

53646

69,00€



KIT PULIDORA NEUMÁTICA DE 3"



REF.	DESCRIPCIÓN				€
A	14286 ESPONJA NARANJA DE POLIÉTER PARA REF. 53646	0.01	10	200	2,99€
B	14287 ESPONJA Densa REF. 53646	0.00	10	200	2,99€
C	14288 ESPONJA DE LANA PARA REF. 53646	0.01	10	200	6,00€
D	14289 DISCO DE VELCRO PARA REF. 53646	0.04	-	200	6,10€

53626

18,00€

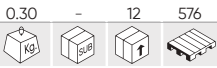

KIT DE PULIDO DE FAROS

14 PCS



EN EXPOSITOR DE 12 UNIDADES

CONTIENE

	x2 P800 Disco para lijar		x1 85g Pasta Pulidora
	x2 P1200 Disco para lijar		x1 Cinta adhesiva
	x2 P2000 Disco para lijar		x1 Disco Pulidor de Lana
	x2 3.0ml Liquido protector UV		x1 Disco Esponja Blanco
	x2 Adaptador (3/8" & 1/4")		



SERIE262

199,00€

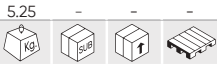

KIT ESPECIAL PULIDO: PULIDORA + 12 KIT DE PULIDO DE FAROS

53626

53646

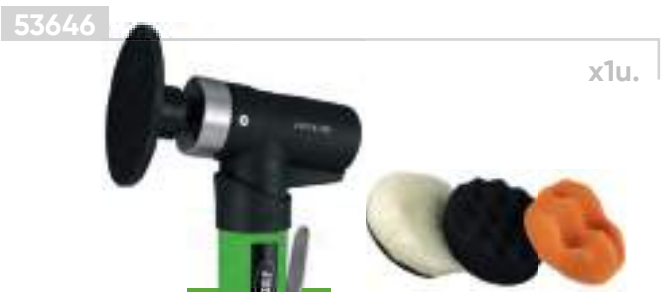

52676

98,00€

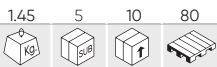

KIT LIJADORA ORBITAL AUTO-ASPIRANTE



- Cuerpo de aluminio con empuñadura engomada.
- Excelente limpieza con bolsa y manguera.



52675

84,00€

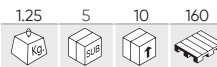

LIJADORA ORBITAL ADAPTABLE A ASPIRADOR



52758

88,00€

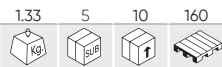

LIJADORA ORBITAL ADAPTABLE A ASPIRADOR



51226

233,00€

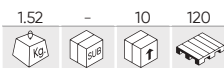

KIT LIJADORA NEUMÁTICA



REF. DESCRIPCIÓN

REF.	DESCRIPCIÓN	kg	SUB	1	€
14133	SET DE REPARACIÓN HERRAMIENTA NEUMÁTICA - 51226	0.01	-	10	16,50€

52157

48,00€

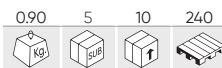

ESTUCHE DE 16 PIEZAS CON AMOLADORA NEUMÁTICA



51245

99,00€



MINI AMOLADORA DE 3/8" 6MM



REF. DESCRIPCIÓN

REF.	DESCRIPCIÓN	kg	SUB	1	€
14135	SET DE REPARACIÓN HERRAMIENTA NEUMÁTICA - 51245	0.01	-	10	12,50€

52171

39,00€



MINI AMOLADORA NEUMÁTICA 1/4"



53141

68,00€



AMOLADORA ANGULAR 1/4"



52528

49,00€



AMOLADORA ANGULAR NEUMÁTICA



53137

38,00€

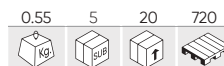

MINI AMOLADORA 1/4"



51218

288,00€

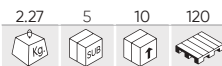

AMOLADORA ORBITAL COMPOSITE

COMPOSITE



REF. DESCRIPCIÓN

REF.	DESCRIPCIÓN	kg	SUB	1	€
14127	SET DE REPARACIÓN HERRAMIENTA NEUMÁTICA - 51218	0.01	-	10	32,50€

HERRAMIENTAS NEUMÁTICAS

54255

68,00€

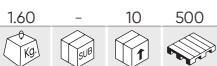

SET DE ACCESORIOS PARA PISTOLA ENGRASADORA

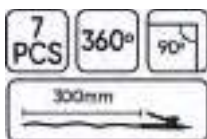

50751

43,00€

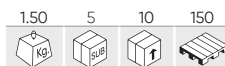

PISTOLA ENGRASADORA NEUMÁTICA

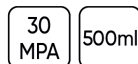

52490

6,65€

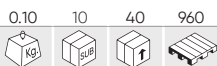

PISTOLA DE AIRE 100MM

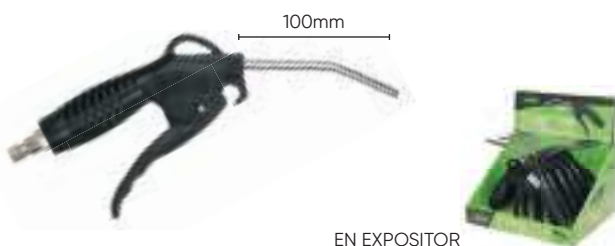

EN EXPOSITOR DE 10 UNIDADES

52491

10,50€



PISTOLA DE AIRE 300MM

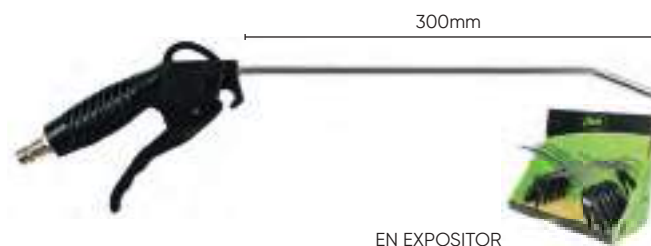

EN EXPOSITOR DE 10 UNIDADES

53611

27,50€



PISTOLA DE AIRE EXTRALARGA



GRAN CAUDAL

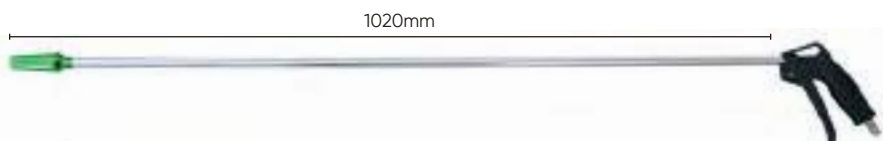

52798

18,00€

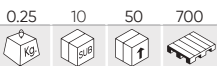

PISTOLA DE AIRE EXTENSIBLE



PUNTA RECUBIERTA DE GOMA PARA EVITAR RAYADURAS

51980

15,00€

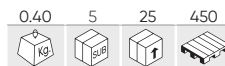

PISTOLA DE AIRE PARA INFLAR NEUMÁTICOS



51981 21,50€

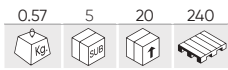

PISTOLA DE AIRE + PISTOLA PARA INFLAR NEUMÁTICOS



51277 64,00€

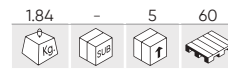

SET DE HERRAMIENTAS DE AIRE COMPRIMIDO



52787 9,00€

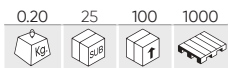

PISTOLA DE SOPLADO EN BLISTER INDIVIDUAL

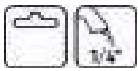

51383 11,10€

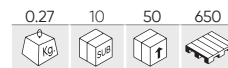

PISTOLA DE SOPLADO EN BLISTER

- Pistola de aire.
- Enganche rápido europeo.
- Enganche de manguera.
- Extensor de tubo 10 cm.
- Extensor de tubo 20 cm.



EN EXPOSITOR DE 10 UNIDADES



54251 43,00€

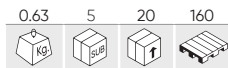

PISTOLA DE ASPIRACIÓN Y SOPLADO



CONTIENE



53205 19,00€



PISTOLA DE SOPLADO GRAN CAUDAL



GRAN CAUDAL

- Pistola de soplado de gran caudal.
- Material del cuerpo: Aleación de aluminio.
- Superficie: Niquelado.

52381 20,50€



SOPLADOR DE 3/8" CON MANGUERA DE 5M



54248

58,00€

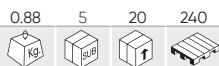

PISTOLA NEUMÁTICA PARA PINTAR

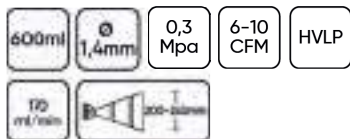

DESPIECE DISPONIBLE

54249

103,00€

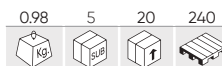

PISTOLA NEUMÁTICA PROFESIONAL PARA PINTAR



DESPIECE DISPONIBLE

53606

55,00€

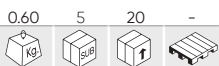

PISTOLA DE SECADO NEUMÁTICA



VÁLVULA REGULADORA DE AIRE



53449

16,40€

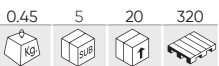

PISTOLA DE INFLADO ANALÓGICA

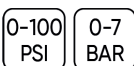

53450

28,30€



PISTOLA DE INFLADO DIGITAL



52648

9,00€



COMPROBADOR DE PRESIÓN DE NEUMÁTICOS (4,3 BAR)



4,3 BAR

53416

14,10€



COMPROBADOR DE PRESIÓN DE NEUMÁTICOS CON TUBO (0-10 BAR)



0-10 BAR

53417

26,30€



COMPROBADOR DE PRESIÓN DE NEUMÁTICOS DIGITAL CON TUBO (0-15 BAR)



0-200 PSI
0-15 BAR
0-1500 KPA

53418

16,90€

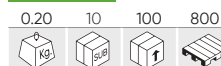

COMPROBADOR DE PRESIÓN DIGITAL DE NEUMÁTICOS (0-15 BAR)



0-300 PSI
0-15 BAR
0-1500 KPA

51861

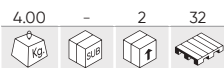

199,00€



HERRAMIENTA NEUMÁTICA PARA EL MONTAJE DE FUELLES DE PALIER

- Material: aluminio.
- Apertura de 20 a 100mm.

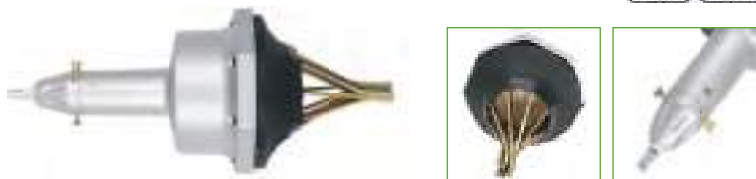

53542



980,00€

DESTALONADOR DE LLANTAS DE NEUMÁTICO



REF. DESCRIPCIÓN

14137 SET DE REPARACIÓN HERRAMIENTA NEUMÁTICA - 53542

0,65 5 5 131,00€

52540



221,00€

VENTOSA NEUMÁTICA PARA ABOLLADURAS

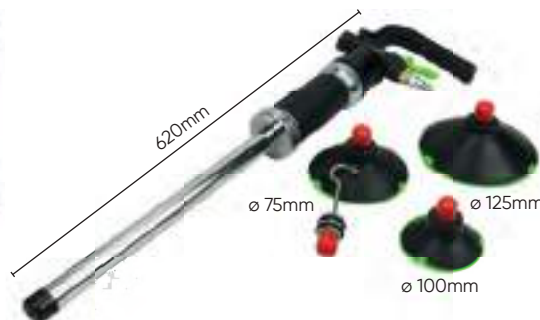

52331

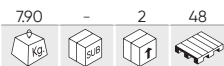

201,00€

KIT HERRAMIENTAS NEUMÁTICAS

PISTOLA DE IMPACTO + MARTILLO NEUMÁTICO + CARRACA NEUMÁTICA + MINI PULIDORA NEUMÁTICA + PISTOLA DE SOPLADO + PISTOLA DE SOPLADO RECTA + ACCESORIOS



HERRAMIENTAS NEUMÁTICAS

52543

182,00€



PISTOLA LIMPIADORA DE FILTROS DE PARTÍCULAS

- Universal.
- Capacidad Máxima 650cc.
- Manguera de Nylon de 4x6x2.7m.
- Rango de presión de trabajo: 3 bar - 7 bar.
- Cuerpo inoxidable de larga duración + base de aluminio.



REF.	DESCRIPCIÓN	Kg	Sub	U	Paq	€
90003	DESCARBONIZANTE LÍQUIDO	1.08	-	12	400	35,20€
90004	NEUTRALIZANTE LÍQUIDO	0.50	-	12	320	25,80€

53625

68,00€

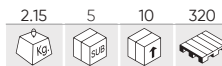

MARTILLO DE AGUJAS NEUMÁTICO



REF.	DESCRIPCIÓN	Kg	Sub	U	Paq	€
14188	AGUJA RECAMBIO PARA REF. 53625	0.01	50	500	0,50€	

53593

41,00€



PISTOLA CHORREADORA DE ARENA



- CONTIENE**
- 1x Pistola chorreadora.
 - 1x Recogedor de arena.
 - 2x Botes arena de 850g.

- x4 Casquillos: para chorreado.
- para chorreado en superficie.
- para chorreado de esquina exteriores.
- para chorreado de esquina interiores.

REF.	DESCRIPCIÓN	Kg	Sub	U	Paq	€
14168	BOTELLA DE ARENA PARA PISTOLA CHORREADORA (REF.53593)	0.95	-	20	7,00€	

53202

15,70€



PISTOLA DE PETROLEAR



- Pistola de limpieza del motor.
- Material del bote: Acero.
- Material del cuerpo: Aleación de aluminio.
- Superficie: Pintura en polvo.

53204

81,00€

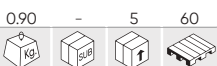

PISTOLA DE LIMPIEZA TORNADO



- Pistola de limpieza de coches, tornado.
- Material pote: PE.
- Material del cuerpo: Aleación de aluminio.
- Superficie del cuerpo: Pulido.

52575

119,00€



REMACHADORA NEUMÁTICA



53567

43,00€

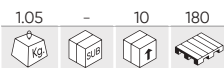

PISTOLA DE SILICONA NEUMÁTICA



- Presión de trabajo: 2,5-5 BAR.
- Entrada de aire: 1/4".
- Capacidad del cartucho: 310ml.

52533

10,00€



PISTOLA DE SILICONA PROFESIONAL

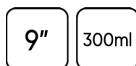

53572

348,00€



HERRAMIENTA NEUMÁTICA PARA ESMERILAR VÁLVULAS - PERCUSIÓN Y ROTACIÓN

CONTIENE

- 1 x Máquina neumática para válvulas.
- 1 x 3mm Llave Allen.
- 5 x Adaptador de válvula.
- 5 x Ventosa (16, 20, 30, 35 y 40mm).



54033

49,00€

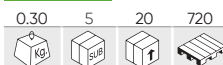

ESMERILADOR DE VÁLVULAS PARA TALADRO

- Diámetro ventosas: 16, 20, 30, 35, 40mm
- Conexión taladro: 8mm
- Longitud: 128mm
- Velocidad de trabajo máxima: 1250rpm



REF.	mm				€
14157	16	0.01	-	50	8,30€
14158	20	0.01	-	50	9,95€
14159	30	0.01	-	50	12,60€
14160	35	0.01	-	50	12,80€
14161	40	0.10	-	50	13,70€



REF.	mm				€
14157	16	0.01	-	50	8,30€
14158	20	0.01	-	50	9,95€
14159	30	0.01	-	50	12,60€
14160	35	0.01	-	50	12,80€
14161	40	0.10	-	50	13,70€



14534

16,50€



ACEITE LUBRICANTE PARA HERRAMIENTAS NEUMÁTICAS - 600ML

- Densidad relativa a 15°C: 0,845.
- Viscosidad: 12,1 cSt a 40°C.
- Color: Incoloro.



14560

8,80€



ACEITE LUBRICANTE PARA HERRAMIENTAS NEUMÁTICAS - 100ML

- Densidad relativa a 15°C: 0,845.
- Viscosidad: 12,1 cSt a 40°C.
- Color: Incoloro.



HERRAMIENTAS NEUMÁTICAS



DISCOS DE CORTE

REF.	DESCRIPCIÓN					€
51385	DISCO DE CORTE DE 4"X1/32" PARA 51219	0.01	10	300	800	4,55€
51387	DISCO DE CORTE DE 3"	0.03	10	300	800	3,25€



DISCOS DE LIJAR

REF.	DESCRIPCIÓN					€
51386	DISCO DE LIJA DE 5" PARA 51218	0.10	-	25	800	5,95€
51443	DISCO DE LIJA DE #60 PARA 51226	0.50	25	150	800	5,50€
51444	DISCO DE LIJA DE #80 PARA 51226	0.02	-	25	800	5,05€
51445	DISCO DE LIJA DE #120 PARA 51226	0.02	-	25	800	5,05€



DISCOS PARA LIJADORAS

REF.	DESCRIPCIÓN					€
13499	DISCO DE 15 AGUJEROS PARA LIJADORAS	0.10	-	50	1500	12,50€
13500	DISCO DE 66 AGUJEROS PARA LIJADORAS	0.65	5	50	-	12,90€
12009	DISCO DE 6 AGUJEROS PARA LIJADORAS	0.14	-	50	-	11,00€



FILTRO Y REGULADOR DE AIRE

REF.	"					€
53063	1/4"	0.60	5	50	300	36,70€
53064	3/8"	0.63	5	50	300	37,40€
53065	1/2"	0.60	5	50	300	36,90€



FILTRO, REGULADOR DE AIRE Y LUBRICADOR

REF.	"					€
53066	1/4"	1.08	5	25	250	61,00€
53067	3/8"	0.50	5	25	250	61,00€
53068	1/2"	1.00	5	25	250	63,00€



53492

380,00€

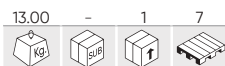

EXPOSITOR DE HERRAMIENTAS NEUMÁTICAS



HERRAMIENTAS NO INCLUIDAS



52378

10,00€

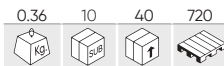

COLGADOR IMANTADO PARA HERRAMIENTA NEUMÁTICA



53147

41,00€

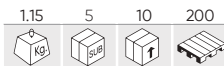

EXPOSITOR DE HERRAMIENTA NEUMÁTICA



HERRAMIENTAS NO INCLUIDAS

53594

54,00€



MANGUERA DE AIRE 8MM - 25M



HYBRID POLYMER
POLÍMERO HÍBRIDO

- Presión de trabajo: 300PSI / 20bar.
- Presión de rotura: 950PSI / 65bar.
- Temperatura de trabajo: -40°C / 65°C

- Gran flexibilidad.
- Regresa a su forma original.
- Superficie suave, no daña pintura.
- Muy resistente.

Diámetro interior: 8mm
Diámetro exterior: 13mm

Para utilizar con:
REF. 52736 (M8)



53595

61,00€



MANGUERA DE AIRE 10MM - 25M



HYBRID POLYMER
POLÍMERO HÍBRIDO

- Presión de trabajo: 300PSI / 20bar.
- Presión de rotura: 950PSI / 65bar.
- Temperatura de trabajo: -40°C / 65°C

- Gran flexibilidad.
- Regresa a su forma original.
- Superficie suave, no daña pintura.
- Muy resistente.

Diámetro interior: 10mm
Diámetro exterior: 15mm

Para utilizar con:
REF. 52737 (M10)



REF. DESCRIPCIÓN

14169 BOLSA DE 10 ABRAZADERAS 8-16MM

0.10 - 125 - 3,00€

HERRAMIENTAS NEUMÁTICAS

MANGUERAS DE AIRE EN ESPIRAL

REF.	m			"					€
53629	10m	8mm	5mm	1/4"	0.55	-	6	360	14,30€
53630	15m	8mm	5mm	1/4"	0.65	-	6	240	18,80€
53631	15m	12mm	8mm	1/4"	1.25	-	6	120	33,50€
53632	15m	15mm	10mm	1/4"	2.20	-	6	78	46,00€
53633	15m	15mm	10mm	3/8"	2.10	-	6	78	46,00€
53634	15m	18mm	13mm	1/2"	2.60	-	6	66	63,00€



CON EXTREMOS GIRATORIOS DE 360 GRADOS PARA UN FÁCIL MOVIMIENTO Y FACILIDAD DE USO

- MATERIAL DE LA MANGUERA: POLIURETANO.
- MATERIAL DE LA ROSCA: LATÓN.

CARRETE DE MANGUERA DE AIRE



CON REPARTIDOR



CON SOPORTE DE PARED INCLUIDO

14772 8,50€

0.35	-	20	-

REF. 53582 / REF. 53583



CON SOPORTE DE PARED INCLUIDO

14771 10,50€

0.35	-	30	-

REF. 53532 / REF. 53581

20+2m

REF.	m	"					€
53582	22m	3/8"	10.85	-	1	14	174,00€
53583	22m	3/8"	10.75	-	1	14	174,00€



12+1m

REF.	m	"					€
53532	13m	3/8"	6.60	-	2	30	119,00€
53581	13m	3/8"	6.70	-	2	30	119,00€



10+1,5m

REF.	m	"					€
53881	11,5m	1/4"	4.50	-	4	48	79,00€
53882	11,5m	1/4"	4.50	-	4	48	79,00€



CONECTOR PARA MANGUERA

REF.	DESCRIPCIÓN					€
14204	EUR - M6 M 1/4"	0.06	50	200	-	1,50€
14205	EUR - M8 M 3/8"	0.06	50	200	-	1,50€
14206	EUR - M10 M 1/2"	0.05	50	200	-	1,50€
14207	US - M6 M 1/4"	0.05	50	200	-	1,50€
14208	US - M8 M 3/8"	0.06	50	200	-	1,50€
14209	US - M10 M 1/2"	0.05	50	200	-	1,50€



CONECTOR UNIVERSAL DE SEGURIDAD PARA MANGUERA

REF.	DESCRIPCIÓN					€
14201	M6	0.10	25	100	-	4,00€
14202	M8	0.10	25	100	-	4,00€
14203	M10	0.10	25	100	-	4,50€



CONECTOR / ROSCA

REF.	DESCRIPCIÓN				€
13930	CONECTOR MACHO US - ROSCA MACHO 1/4"	0.01	50	100	1,50€
13932	CONECTOR MACHO US - ROSCA MACHO 3/8"	0.10	50	100	2,50€
14076	CONECTOR MACHO US - ROSCA HEMBRA 3/8"	0.10	50	100	1,50€
13933	CONECTOR MACHO US - ROSCA MACHO 1/2"	0.10	50	100	2,00€
13935	CONECTOR MACHO US - ROSCA HEMBRA 1/4" (2UDS)	0.05	50	100	2,50€
13936	CONECTOR HEMBRA US - ROSCA HEMBRA 1/4"	0.05	50	100	3,50€
13937	CONECTOR HEMBRA US - ROSCA MACHO 1/4"	0.05	50	100	4,00€
14078	CONECTOR HEMBRA US - ROSCA HEMBRA 3/8"	0.10	50	100	4,00€
14191	CONECTOR MACHO US - ROSCA HEMBRA 1/2"	0.05	50	100	2,00€
14193	CONECTOR HEMBRA US - ROSCA HEMBRA 1/2"	0.10	50	100	4,00€



REF.	DESCRIPCIÓN				€
13931	CONECTOR MACHO EUR - ROSCA MACHO 1/4" (2UDS)	0.05	50	100	2,50€
14075	CONECTOR MACHO EUR - ROSCA HEMBRA 3/8"	0.10	50	100	2,00€
13934	CONECTOR MACHO EUR - ROSCA HEMBRA 1/4" (2UDS)	0.05	50	100	2,50€
13938	CONECTOR HEMBRA EUR - ROSCA HEMBRA 1/4"	0.10	50	200	3,50€
13939	CONECTOR HEMBRA EUR - ROSCA MACHO 1/4"	0.10	50	100	4,00€
14077	CONECTOR HEMBRA EUR - ROSCA HEMBRA 3/8"	0.10	50	100	4,50€
14190	CONECTOR MACHO EUR - ROSCA HEMBRA 1/2"	0.05	50	100	2,00€
14192	CONECTOR HEMBRA EUR - ROSCA HEMBRA 1/2"	0.10	50	100	4,00€



HERRAMIENTAS NEUMÁTICAS

CONECTOR DE SEGURIDAD UNIVERSAL

REF.	DESCRIPCIÓN						€
14195	CONECTOR HEMBRA - ROSCA MACHO 1/4"	0.50	25	100	-	-	4,00€
14196	CONECTOR HEMBRA - ROSCA MACHO 3/8"	0.10	25	100	-	-	4,00€
14197	CONECTOR HEMBRA - ROSCA MACHO 1/2"	0.10	25	100	-	-	4,50€
14198	CONECTOR HEMBRA - ROSCA HEMBRA 1/4"	0.10	25	100	-	-	4,00€
14199	CONECTOR HEMBRA - ROSCA HEMBRA 3/8"	0.10	25	100	-	-	4,00€
14200	CONECTOR HEMBRA - ROSCA HEMBRA 1/2"	0.10	25	100	-	-	4,50€



CONECTOR ARTICULADO MACHO PARA AIRE COMPRIMIDO

REF.	DESCRIPCIÓN						€
14314	EUR 1/4"	0.06	25	100	-	-	5,00€
14315	US 1/4"	0.06	25	100	-	-	4,50€



14561

0.05	25	50	-

CONECTOR LUBRICANTE 1/4"



8,80€



ENGANCHE NEUMÁTICO RÁPIDO

REF.	DESCRIPCIÓN						€
52735	ENGANCHE NEUMÁTICO RÁPIDO M6	0.05	25	200	4000	-	4,85€
52736	ENGANCHE NEUMÁTICO RÁPIDO M8	0.10	25	200	4000	-	5,35€
52737	ENGANCHE NEUMÁTICO RÁPIDO M10	0.10	25	200	4000	-	5,50€



ADAPTADOR ARTICULADO

REF.	DESCRIPCIÓN						€
12988	ADAPTADOR ARTICULADO 1/2"	0.15	62	125	-	-	12,00€
13809	ADAPTADOR ARTICULADO 1/4"	0.10	62	250	-	-	18,50€
13810	ADAPTADOR ARTICULADO 3/8"	0.10	62	250	-	-	20,50€



ÚTILES, VASOS Y PUNTAS DE IMPACTO

- 168 SETS DE VASOS DE IMPACTO
- 173 ESPECIAL RUEDAS
- 174 ADAPTADORES
- 176 DESPIECE DE VASOS DE IMPACTO
- 177 ESPECIAL CAMIÓN



52694

49,00€

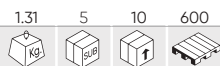

SET DE 3 VASOS XZN DE 1/2" DE IMPACTO



CONTIENE

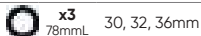

52337

65,00€

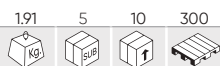

SET DE 3 VASOS Y 3 PUNTAS DE IMPACTO DE 1/2" HEXAGONAL

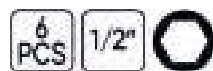

CONTIENE

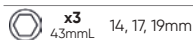
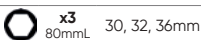

52547

96,00€



SET DE 5 VASOS Y 3 PUNTAS XZN DE IMPACTO DE 1/2"

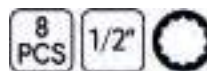

CONTIENE

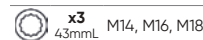
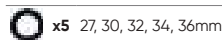

52345

109,00€



SET DE 19 PIEZAS DE IMPACTO DE 1/2" CON 14 VASOS HEXAGONALES + ADAPTADORES

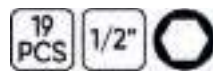

10, 11, 12, 13, 14, 15, 16, 17, 18, 19, 21, 22, 24, 27mm



DESPIECE DISPONIBLE

REF.	mm				€
14728	10	0.10	5	20	3,80€
14729	11	0.05	10	100	3,80€
14730	12	0.05	10	100	3,80€
14731	13	0.10	5	20	3,80€
14732	14	0.10	5	20	3,80€
14970	15	0.08	5	20	2,50€
14971	16	0.07	5	20	2,50€

REF.	mm				€
11195	17	0.10	10	100	3,70€
14972	18	0.12	5	20	3,50€
11121	19	0.10	10	60	4,10€
14733	21	0.10	5	20	4,30€
14734	22	0.15	5	20	5,40€
11122	24	0.14	10	20	5,45€
11123	27	0.20	10	50	6,50€

REF.	DESCRIPCIÓN				€
12937	BARRA DE EXTENSIÓN DE IMPACTO 1/2" 50 MM	0.11	10	100	9,50€
14973	BARRA DE EXTENSIÓN DE IMPACTO 1/2" 150MM	0.27	5	20	11,50€
12075	BARRA DE EXTENSIÓN DE IMPACTO DE 1/2" 250MM	0.45	10	50	15,50€
11962	ADAPTADOR DE IMPACTO 1/2"H 3/4"M	0.17	10	100	7,50€
11990	ARTICULACIÓN UNIVERSAL DE IMPACTO 1/2"	0.15	10	100	15,30€

53531

109,00€



SET DE 19 PIEZAS DE IMPACTO DE 1/2" CON 14 VASOS DE 12 CANTOS + ADAPTADORES



DESPIECE DISPONIBLE

REF.	DESCRIPCIÓN				€
12937	BARRA DE EXTENSIÓN DE IMPACTO 1/2" 50 MM	0.11	10	100	9,50€
14973	BARRA DE EXTENSIÓN DE IMPACTO 1/2" 150MM	0.27	5	20	11,50€
12075	BARRA DE EXTENSIÓN DE IMPACTO DE 1/2" 250MM	0.45	10	50	15,50€

REF.	DESCRIPCIÓN				€
11962	ADAPTADOR DE IMPACTO 1/2"H 3/4"M	0.17	10	100	7,50€
11990	ARTICULACIÓN UNIVERSAL DE IMPACTO 1/2"	0.15	10	100	15,30€

52341

58,00€

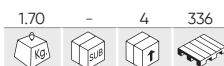

SET DE VASOS DE IMPACTO DE 13 PIEZAS DE 1/2" HEXAGONAL + ADAPTADOR

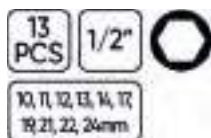

DESPIECE DISPONIBLE

REF.	mm				€
14728	10	0.10	5	20	3,80€
14729	11	0.05	10	100	3,80€
14730	12	0.05	10	100	3,80€
14731	13	0.10	5	20	3,80€
14732	14	0.10	5	20	3,80€

REF.	mm				€
11195	17	0.10	10	100	3,70€
11121	19	0.10	10	60	4,10€
14733	21	0.10	5	20	4,30€
14734	22	0.15	5	20	5,40€
11122	24	0.14	10	20	5,45€

REF.	DESCRIPCIÓN				€
14735	ADAPTADOR DE IMPACTO 1/2"	0.05	5	20	6,50€
12074	BARRA DE EXTENSIÓN DE IMPACTO DE 1/2" 125MM	0.23	10	60	11,50€
11990	ARTICULACIÓN UNIVERSAL DE IMPACTO 1/2"	0.15	10	100	15,30€

52346

103,00€



SET DE 15 PIEZAS DE IMPACTO CON 12 VASOS LARGOS DE 1/2" HEXAGONALES + ADAPTADORES

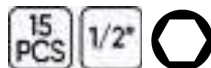

DESPIECE DISPONIBLE

REF.	mm				€
12061	10	0.14	10	100	9,50€
12062	12	0.15	10	100	9,50€
12063	13	0.15	10	50	9,50€
12064	15	0.17	10	100	9,00€
12065	16	0.30	10	20	9,00€
12066	17	0.20	10	100	9,00€

REF.	mm				€
12067	18	0.22	10	20	9,50€
12068	19	0.21	10	50	9,50€
12069	21	0.25	10	50	9,50€
12070	22	0.27	10	100	10,50€
12071	24	0.30	10	50	11,00€
12072	27	0.36	10	20	12,00€

REF.	DESCRIPCIÓN				€
12074	BARRA DE EXTENSIÓN DE IMPACTO DE 1/2" 125MM	0.23	10	60	11,50€
12075	BARRA DE EXTENSIÓN DE IMPACTO DE 1/2" 250MM	0.45	10	50	15,50€
11990	ARTICULACIÓN UNIVERSAL DE IMPACTO 1/2"	0.15	10	100	15,30€

53060

34,90€

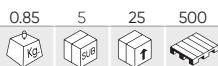

SET DE 12 VASOS DE IMPACTO DE 1/2" HEXAGONAL PERFIL BAJO



52342

63,00€

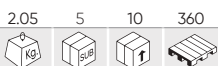

SET DE 11 VASOS DE IMPACTO HEXAGONAL DE 1/2"

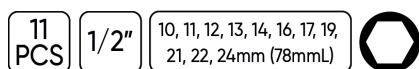

DESPIECE DISPONIBLE

REF.	mm				€
12061	10	0.14	10	100	9,50€
14736	11	0.15	5	20	5,00€
12062	12	0.15	10	100	9,50€
12063	13	0.15	10	50	9,50€
14737	14	0.15	5	20	5,00€
12065	16	0.30	10	20	9,00€

REF.	mm				€
12066	17	0.20	10	100	9,00€
12068	19	0.21	10	50	9,50€
12069	21	0.25	10	50	9,50€
12070	22	0.27	10	100	10,50€
12071	24	0.30	10	50	11,00€

53744

63,00€

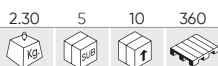

SET DE 11 VASOS DE IMPACTO 12 CANTOS 1/2" LARGOS

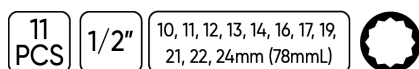

DESPIECE DISPONIBLE

REF.	mm				€
14738	10	0.15	10	100	5,50€
14739	11	0.15	10	100	5,50€
14740	12	0.16	10	100	5,55€
14741	13	0.15	10	100	5,55€
14742	14	0.15	10	100	5,55€
14743	16	0.14	10	100	5,15€

REF.	mm				€
14744	17	0.18	10	50	5,35€
14745	19	0.22	10	50	6,25€
14746	21	0.24	10	50	6,40€
14747	22	0.27	10	50	7,10€
14748	24	0.30	10	50	8,30€

52810

9,00€

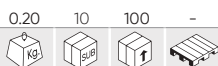

VASO DE IMPACTO XZN INVOLABLE M16

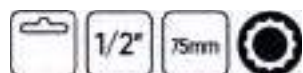

52811

9,90€



VASO DE IMPACTO XZN INVOLABLE M18

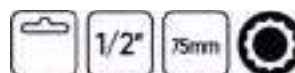

- Vaso de impacto 75 mm de largo y cuadrado de 1/2" para la extracción del tornillo de drenaje con pistola de impacto en transmisiones de vehículos VAG, Porsche, Ford, etc.

- Para la extracción del brazo de dirección en vehículos del grupo VAG.

52546

39,60€

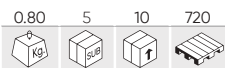

SET DE 6 VASOS PUNTA XZN DE IMPACTO DE 1/2"



DESPIECE DISPONIBLE

REF.	43mmL	kg	SUB	QTY	€	REF.	78mmL	kg	SUB	QTY	€
12931	M14	0.08	10	200	7,50€	12934	M14	0.13	10	200	7,50€
12932	M16	0.08	10	200	7,50€	12935	M16	0.14	10	200	8,00€
12933	M18	0.09	10	200	8,00€	12936	M18	0.16	10	200	8,50€

52344

197,00€

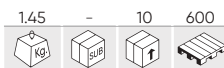

SET DE 13 PUNTAS DE IMPACTO DE 1/2" HEXAGONAL Y TORX

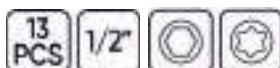

CONTIENE

- x5 45mmL 5, 6, 8, 10, 12mm
- x8 45mmL T30, T40, T45, T50, T55, T60, T70, T80

52339

61,00€



SET DE 8 PUNTAS DE IMPACTO HEXAGONAL DE 1/2"



DESPIECE DISPONIBLE

REF.	mm	kg	SUB	QTY	€	REF.	mm	kg	SUB	QTY	€
14004	5	0.30	10	240	9,50€	14008	10	0.11	10	240	9,50€
14005	6	0.09	10	120	10,50€	14009	12	0.12	10	240	9,50€
14006	7	0.09	10	240	9,50€	14010	14	0.14	10	120	11,00€
14007	8	0.10	10	240	9,50€	14011	17	0.18	10	60	11,00€

52340

58,00€



SET DE 8 PUNTAS DE IMPACTO TORX DE 1/2"



DESPIECE DISPONIBLE

REF.	mm	kg	SUB	QTY	€	REF.	mm	kg	SUB	QTY	€
12938	T25	0.08	10	50	10,00€	12942	T50	0.10	10	60	10,00€
12939	T30	0.10	10	50	10,00€	12943	T55	0.10	10	50	10,00€
12940	T40	0.10	10	50	10,00€	12944	T60	0.12	10	50	10,00€
12941	T45	0.09	10	50	10,00€	12945	T70	0.15	10	50	10,50€

53470

176,00€

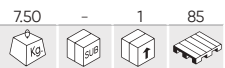

SET DE 8 VASOS DE IMPACTO LARGOS HEXAGONALES DE 3/4"

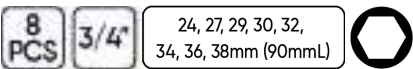

52347

158,00€

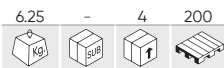

SET DE 8 VASOS DE IMPACTO HEXAGONALES 3/4"

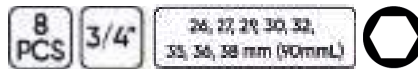

51028

163,00€



SET DE 16 PUNTAS DE IMPACTO

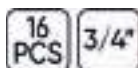

DESPIECE DISPONIBLE

REF.	mm				€
14723	H17	0.35	-	10	18,00€
14724	T60	0.30	-	10	18,50€
14725	T70	0.30	-	10	18,50€
14726	T80	10.80	-	10	17,50€

	3/4"	x4	E18, E20, E22, E24
	3/4"	x5	T60, T70, T80, T90, T100
	3/4"	x4	H17, H19, H22, H24
		x2	1 - 3/4"
		x1	4mm



54316

182,00€



N

SET DE 8 VASOS DE IMPACTO DE 1" LARGOS



x6	90mmL	24, 27, 30, 32, 33, 36mm
x2	95mmL	38, 41mm



DESPIECE DISPONIBLE

REF.	mm				€
16304	24	0.60	6	24	31,00€
16305	27	0.70	6	24	31,00€
16571	30	0.77	6	24	32,00€
16572	32	0.95	6	24	33,50€

REF.	mm				€
16574	33	0.94	-	-	34,00€
16575	36	1.00	6	24	34,50€
16576	38	1.25	6	24	35,50€
16577	41	1.32	6	24	36,00€

52348

179,00€

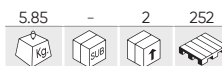

SET DE 8 VASOS DE IMPACTO DE 1"

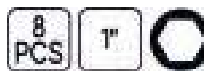

x2	58mmL	24, 27mm
x3	62mmL	30, 32, 33mm
x2	65mmL	36, 38mm
x1	68mmL	41mm



DESPIECE DISPONIBLE

REF.	mm				€
13859	24	0.50	6	24	16,00€
13874	27	0.60	6	72	17,50€
13875	30	0.50	6	18	18,50€
13876	32	0.60	6	24	18,50€

REF.	mm				€
13877	33	0.60	6	96	18,50€
11153	36	0.70	6	18	23,40€
11155	38	0.90	6	12	24,40€
11158	41	0.95	6	18	28,50€

52969

20,70€



SET 3 VASOS IMPACTO LARGOS HEXAGONALES

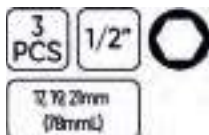

DESPIECE DISPONIBLE

REF.	mm				€
12066	17	0.20	10	100	9,00€
12068	19	0.21	10	50	9,50€
12069	21	0.25	10	50	9,50€



53587

44,00€

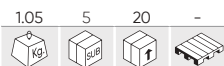

SET DE 4 VASOS DE IMPACTO PARA LLANTAS DE ALEACIÓN - 1/2"



DESPIECE DISPONIBLE

REF.	mm	mmL		kg	kg	kg	€
14172	15mm	85mmL	SMART	0.20	10	50	8,50€
14173	17mm	85mmL	MERCEDES-BENZ	0.20	10	50	9,50€
14177	22mm	85mmL	OPEL	0.25	10	50	9,50€
14178	21mm	85mmL	HYUNDAI / KIA	0.25	10	50	9,50€

52338

41,00€

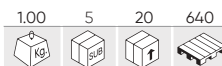

SET DE 4 VASOS IMPACTO DE 1/2" ESPECIAL EXTRACCIÓN RUEDAS

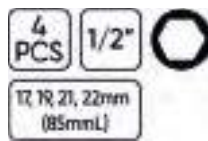

DESPIECE DISPONIBLE

REF.	mm	kg	kg	kg	€
11314	17	0.22	10	100	8,50€
11315	19	0.25	10	100	8,50€
11316	21	0.26	10	100	8,50€
11628	22	0.27	10	50	9,50€



51336

29,30€

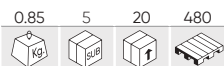

KIT DE 3 VASOS IMPACTO DE 1/2" ESPECIAL EXTRACCIÓN RUEDAS

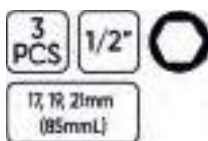

DESPIECE DISPONIBLE

REF.	mm	kg	kg	kg	€
11314	17	0.22	10	100	8,50€
11315	19	0.25	10	100	8,50€
11316	21	0.26	10	100	8,50€

52343

52,00€



SET DE 12 VASOS DE IMPACTO DE 1/2" HEX. ESPECIAL EXTRACCIÓN RUEDAS

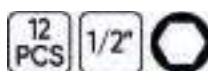

CONTIENE

x3	85mmL	17, 19, 21mm
	x1	42mmL 27mm
x8	38mmL	10, 11, 13, 14, 17, 19, 22, 24mm

53988

101,00€



KIT DE 10 VASOS IMPACTO DE 1/2" ESPECIAL EXTRACCIÓN RUEDAS

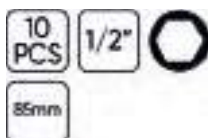

CONTIENE

A	1/2"	15mm	F	1/2"	23mm
B	1/2"	17mm	G	1/2"	24mm
C	1/2"	19mm	H	7/8"	TESLA
D	1/2"	21mm	I	17mm	MERCEDES
E	1/2"	22mm	J	21mm	HYUNDAI / KIA



53197

46,00€

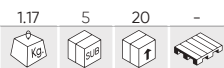

SET DE 4 VASOS DE IMPACTO PARA TORNILLOS DE SEGURIDAD



CONTIENE

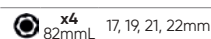

53077

62,00€



SET DE BARRAS DE EXTENSIÓN DE IMPACTO

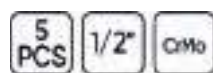

DESPIECE DISPONIBLE

	REF.	Nm					€
A	13688	100	0.22	-	-	1500	15,50€
B	13687	110	0.22	5	50	-	15,50€
C	13686	120	0.23	5	50	1000	15,50€
D	13685	135	0.25	5	50	1500	15,50€
E	13684	150	0.28	-	50	-	15,50€



TAMBIÉN TE PUEDE INTERESAR...

	REF.	Nm					€
F	13680	200	0.36	50	50	-	15,50€
G	13681	190	0.35	-	50	-	15,50€
H	13682	175	0.32	-	50	-	15,50€
I	13683	160	0.30	-	50	-	15,50€
J	13689	90	0.20	5	50	1500	15,50€



BARRA DE EXTENSIÓN DE IMPACTO

REF.	mm	"					€
12937	50	1/2"	0.11	10	100	1500	9,50€
12074	125	1/2"	0.23	10	60	-	11,50€
12075	250	1/2"	0.45	10	50	-	15,50€

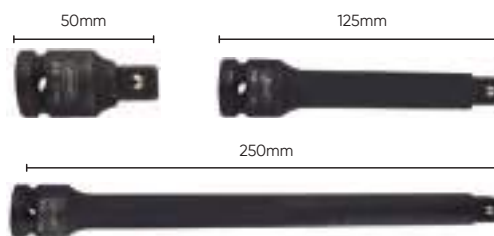

ARTICULACIÓN UNIVERSAL DE IMPACTO

REF.	"					€
11938	3/4"	0.62	10	50	-	47,00€
11990	1/2"	0.15	10	100	-	15,30€



53043

53,00€

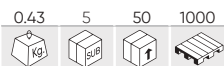

SET 3 ARTICULACIONES IMPACTO CON DOBLE POSICIÓN (FIJO/ARTICULADO)



53044

121,00€



SET 8 VASOS IMPACTO HEXAGONALES CON DOBLE POSICIÓN (FIJO/ARTICULADO)



13, 14, 15, 16,
17, 19, 21, 22mm



52545

177,00€



JUEGO DE DOS ADAPTADORES DE IMPACTO

1" 1/2" F - 1" M
1" F - 1" 1/2" M



53743

39,70€



ESTUCHE DE 6 ADAPTADORES DE IMPACTO



DESPIECE DISPONIBLE

REF.	mm				€
14749	1/4"H - 3/8"M	0.03	20	200	2,00€
14750	3/8"H - 1/4"M	0.05	20	100	2,00€
14751	3/8"H - 1/2"M	0.15	20	100	4,00€
14752	1/2"H - 3/8"M	0.16	10	100	4,00€
11962	1/2"H - 3/4"M	0.17	10	100	7,50€
11964	3/4"H - 1/2"M	0.35	10	100	12,50€

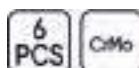

52544

93,00€



SET DE 6 ADAPTADORES DE IMPACTO



DESPIECE DISPONIBLE

REF.	mm				€
11962	1/2"H - 3/4"M	0.17	10	100	7,50€
11963	1/2"H - 1"M	0.25	6	54	9,00€
11964	3/4"H - 1/2"M	0.35	10	100	12,50€
11965	3/4"H - 1"M	0.45	6	48	16,00€
11966	1"H - 1/2"M	0.54	6	36	18,00€
11967	1"H - 3/4"M	0.56	4	36	18,00€

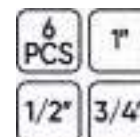

VASOS DE IMPACTO



1"

REF.	mm				€
11153	36	0.70	6	18	23,40€
11154	37	0.73	6	24	21,70€
11155	38	0.90	6	12	24,40€
11156	39	0.74	6	24	28,90€
11157	40	0.78	6	12	26,60€
11158	41	0.95	6	18	28,50€
11159	42	1.00	6	18	30,30€
11160	43	0.95	6	12	27,00€
11161	44	0.90	6	18	32,30€
11162	45	1.10	4	8	29,10€
11163	46	1.00	4	12	32,70€
11164	47	1.05	4	8	30,70€
11165	48	1.00	4	8	34,60€
11166	50	1.21	4	12	30,90€
11167	51	1.18	4	8	38,00€
11168	52	1.18	1	10	41,00€
11169	53	1.27	4	12	39,20€
11170	54	1.33	4	12	40,00€
11171	55	1.44	2	8	51,00€
11172	56	1.47	4	8	48,00€
11173	57	1.44	4	8	47,00€
11174	58	1.58	4	8	47,00€
11175	59	1.58	4	120	49,00€
11176	60	1.75	2	4	56,00€
11177	62	1.63	2	4	55,00€
11178	63	1.75	-	8	53,00€
11179	65	1.87	2	8	65,00€
11180	67	1.93	2	8	59,00€
11181	68	1.93	2	8	65,00€
11182	70	2.05	2	4	73,00€
11183	71	3.10	-	6	70,00€
11184	73	3.27	-	4	87,00€
11185	75	3.34	-	6	97,00€
11186	76	3.35	-	5	91,00€
11187	78	3.47	-	5	98,00€
11188	80	3.60	-	4	103,00€
11189	85	3.80	-	4	121,00€
11190	89	3.80	-	2	138,00€
11191	90	3.90	1	4	149,00€
11192	92	4.85	-	2	152,00€
11193	95	4.90	-	2	183,00€
11194	100	4.43	1	4	176,00€
11621	105	8.50	-	2	290,00€
11622	110	8.13	1	2	399,00€
11623	115	8.62	-	2	489,00€

1" (90mmL)

EXTRALARGOS

REF.	mm				€
13745	28	0.77	6	24	25,20€
13746	30	0.95	6	12	25,40€
13747	32	0.92	6	12	25,40€
13748	33	0.88	6	12	24,90€

1/2"

REF.	mm				€
14728	10	0.10	5	20	3,80€
14729	11	0.05	10	100	3,80€
14730	12	0.05	10	100	3,80€
14731	13	0.10	5	20	3,80€
14732	14	0.10	5	20	3,80€
11195	17	0.10	10	100	3,70€
11121	19	0.10	10	60	4,10€
14733	21	0.10	5	20	4,30€
14734	22	0.15	5	20	5,40€
11122	24	0.14	10	20	5,45€
11123	27	0.20	10	50	6,50€
11124	30	0.20	10	50	7,65€
11125	32	0.23	10	50	8,50€

1/2" (78mmL)

LARGOS

REF.	mm				€
12061	10	0.14	10	100	9,50€
14736	11	0.15	5	20	5,00€
12062	12	0.15	10	100	9,50€
12063	13	0.15	10	50	9,50€
14737	14	0.15	5	20	5,00€
12064	15	0.17	10	100	9,00€
12065	16	0.30	10	20	9,00€
12066	17	0.20	10	100	9,00€
12067	18	0.22	10	20	9,50€
12068	19	0.21	10	50	9,50€
12069	21	0.25	10	50	9,50€
12070	22	0.27	10	100	10,50€
12071	24	0.30	10	50	11,00€
12072	27	0.36	10	20	12,00€

3/4"

REF.	mm				€
11126	19	0.25	-	10	11,20€
11127	21	0.30	6	24	13,80€
11128	22	0.35	6	24	14,10€
11129	24	0.32	6	54	14,10€
11130	25	0.45	6	24	13,10€
11131	26	0.32	6	36	14,10€
11132	27	0.30	6	54	13,70€
11133	28	0.40	6	12	12,00€
11134	30	0.41	6	24	15,00€
11135	32	0.45	6	48	17,20€
11136	33	0.50	6	12	15,30€
11137	34	0.50	6	24	18,20€
11138	35	0.50	6	12	18,00€
11139	36	0.50	6	24	18,80€
11140	38	0.55	6	24	20,40€
11141	40	0.55	6	12	18,60€
11142	41	0.60	6	12	21,30€
11143	46	0.75	6	18	26,40€
11144	50	1.00	6	24	33,30€
11145	51	1.10	4	12	35,30€
11146	55	1.23	4	12	37,30€
11147	57	1.25	4	12	41,00€
11148	60	1.40	4	12	47,00€
11149	63	1.32	4	12	45,00€
11150	65	1.35	-	8	55,00€
11151	67	1.49	4	12	57,00€
11152	70	1.49	4	12	57,00€

3/4" (90mmL)

LARGOS

REF.	mm				€
13723	19	0.43	6	12	18,50€
13724	21	0.50	6	12	19,20€
13725	22	0.61	6	18	19,20€
13726	24	0.56	6	24	19,00€
13727	26	0.51	6	18	18,70€
13728	27	0.50	6	18	18,50€
13729	29	0.70	6	12	22,00€
13730	30	0.70	6	24	22,00€
13731	32	0.71	6	24	21,60€
13732	33	0.75	6	24	23,80€
13733	34	0.85	6	18	24,90€
13734	35	0.80	6	18	25,70€
13735	36	0.81	6	12	25,80€
13736	38	0.83	6	18	25,90€

1"

REF.	mm				€
11624	65	2.40	1	2	189,00€
11625	85	5.35	1	2	282,00€
12984	105	5.00	1	2	379,00€

1/2" (78mmL)

LARGOS

REF.	mm				€
14738	10	0.15	10	100	5,50€
14739	11	0.15	10	100	5,50€
14740	12	0.16	10	100	5,55€
14741	13	0.15	10	100	5,55€
14742	14	0.15	10	100	5,55€
14743	16	0.14	10	100	5,15€
14744	17	0.18	10	50	5,35€
14745	19	0.22	10	50	6,25€
14746	21	0.24	10	50	6,40€
14747	22	0.27	10	50	7,10€
14748	24	0.30	10	50	8,30€
11613	27	0.35	10	20	11,00€
11614	30	0.40	6	24	13,00€
11615	32	0.45	6	24	14,20€
11616	33	0.44	6	12	18,10€
11617	34	0.42	6	24	18,70€
11618	35	0.48	6	18	18,80€
11619	36	0.47	4	48	19,50€

52914 223,00€



VASO TAPACUBOS CAMIÓN
BPW 120MM DR.41MM



120mm
8 CARAS
CUADRADO HEXAGONAL 41mm

52915 199,00€



VASO TUERCA RUEDA
CAMIÓN BPW 111MM DR.41MM



111mm
OVAL
CUADRADO HEXAGONAL 41mm

52916 218,00€



VASO TUERCA RUEDA
CAMIÓN BPW 109MM
DR.41MM



109mm
8 CARAS
CUADRADO HEXAGONAL 41mm

52917 122,00€



VASO EJE TRASERO 6,5-9TON
CAMIÓN BPW 65MM



65mm
OVAL
DIAGONAL 36mm

52918 146,00€



VASO TAPACUBOS TRASERO
EJE BPW 95MM



95mm
CUADRADO 3/4"

52919 181,00€



VASO TUERCA RUEDA BPW
110MM 3/4"



110mm
8 CARAS
CUADRADO 3/4"

52920 155,00€



VASO EXTRACCIÓN
COJINETES EJE BPW 80MM
3/4"



80mm
CUADRADO 3/4"

52921 117,00€



VASO EXTRACCIÓN TUERCA
EJE TRASERO BPW 65MM 3/4"



65mm
CUADRADO 3/4"

52922 180,00€



VASO EXTRACCIÓN TUERCA
COJINETES EJES BPW 85MM
3/4"



85mm
6 CARAS
CUADRADO 3/4"

52923 59,00€



VASO EXTRACCIÓN TUERCA
SUSPENSIÓN SCANIA
28X37MM 3/4"



28x37mm
CUADRADO 3/4"

52924 52,00€



VASO EXTRACCIÓN EJE
SUSPENSIÓN SCANIA
34X46MM 3/4"



34x46mm
CUADRADO 3/4"

52925 176,00€



VASO RUEDA DELANTERA
SCANIA 80MM H41



80mm
8 CARAS
CUADRADO HEXAGONAL 41mm

52926 201,00€



VASO RUEDA TRASERA
SCANIA 100MM 3/4" 8
CANTOS



100mm
8 CARAS
CUADRADO 3/4"

52927 59,00€



VASO AMORTIGUADOR
TRASERO SCANIA 34X56MM
3/4"



34x56mm
CUADRADO 3/4"

52928 172,00€



VASO RUEDA DELANTERA
SCANIA 80MM 3/4" 8 CANTOS



80mm
8 CARAS
CUADRADO 3/4"

52929 185,00€



VASO TUERCA RUEDA SCANIA
95MM 3/4" 8 CANTOS



95mm
8 CARAS
CUADRADO 3/4"

ÚTILES, VASOS Y PUNTAS DE IMPACTO

52930 117,00€



ÚTIL CAMIÓN SCANIA
INSTALACIÓN RETEN TRASERO
ACEITE DEL CIGÜEÑAL



SCANIA 310/320
RETÉN 0366303-R

52931 45,00€



VASO CAMIÓN SCANIA
ROTACIÓN ÁRBOL DE LEVAS
1/2"



CUADRADO 1/2"

52932 45,00€



VASO PARA VÁLVULA
DE INYECCIÓN
ELECTROMAGNÉTICA SCANIA
38MM 1/2"



Ø38mm
CUADRADO 1/2"

52933 194,00€



VASO 8 ALMENAS SCANIA 420



Ø11,6mm - Ø10mm
8 ALMENAS
CUADRADO 3/4"
SCANIA 420

53430 286,00€



VASO DE BUJE PARA IVECO

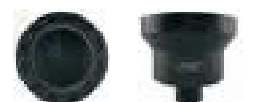

Ø134mm - Ø110,5mm
118x134mm
IVECO
12 CARAS

52935 94,00€



VASO TUERCA PRISIONERA
CAMIÓN BENZ/MAN 60MM



60mm
CUADRADO 3/4"

52936 199,00€



VASO EJE TRASERO CAMIÓN
BENZ/MAN 80-95MM



80-95mm
CUADRADO 3/4"
6 ALMENAS

52937 265,00€



VASO EXTRACCIÓN TUERCA
EJE TRASERO CAMIÓN BENZ/
MAN 95-115MM



95-115mm
CUADRADO 3/4"
6 ALMENAS

52938 199,00€



VASO EXTRACCIÓN TUERCA
DIRECCIÓN CAMIÓN BENZ/
MAN H60 3/4"



100mm
CUADRADO 3/4"
6 ALMENAS

52939 28,00€



VASO CAMIÓN BENZ/MAN
PARA EXTRACCIÓN VÁLVULA
INYECCIÓN DIESEL



22-28mm
CUADRADO 1/2"
4 ALMENAS

52940 235,00€



VASO CAMIÓN BENZ/MAN
PARA TUERCA DIFERENCIAL
TRASERO



101mm
CUADRADO 3/4"
6 ALMENAS

52941 70,00€



ÚTIL ROTACIÓN VOLANTE
DE MOTOR BENZ Y MAN 2
ENGRANAJES



CUADRADO 1/2"

52942 105,00€



ÚTIL ROTACIÓN VOLANTE
DE MOTOR BENZ Y MAN 3
ENGRANAJES



CUADRADO 1/2"

52943 75,00€



ÚTIL CAMIÓN ROTACIÓN
VOLANTE DE MOTOR MAN



CUADRADO 1/2"

52934 102,00€



VASO TUERCA PRISIONERA
CAMIÓN BENZ/MAN 56MM



56mm
CUADRADO 3/4"

REF.	mm			€
52944	30	1.00	20	110,00€
52945	39	2.74	24	281,00€

VASO EXTRACCIÓN TUERCA
COJINETES EJE BPW



52944
CUADRADO
HEXAGONAL
19mm

52945
CUADRADO
HEXAGONAL
26mm

CARROCERÍA

- 180 PARA CHAPISTA
- 183 RESTAURACIÓN DE FAROS
- 185 SUSTITUCIÓN DE LUNAS
- 186 REPARACIÓN DE CHASIS
- 188 MOBILIARIO AUXILIAR
- 191 MANTENIMIENTO INTERIOR



53224

142,00€

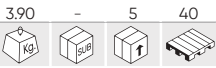

SET REPARADOR DE ABOLLADURAS



DESPIECE DISPONIBLE

REF.	DESCRIPCIÓN				€
13842	BOLSA DE 5 DISCOS AZULES PARA REF.53224	0.15	10	100	- 8,50€
13843	BOLSA DE 4 DISCOS AMARILLOS PARA REF.53224	0.01	10	100	- 7,00€
13844	BOLSA DE 10 DISCOS ROJOS PARA REF.53224	0.05	10	50	- 9,00€
13845	BOLSA DE 5 BARRAS DE PEGAMENTO PARA REF.53224	0.02	10	100	- 8,00€

52876

182,00€

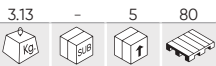

KIT TAS CHAPISTA 7 PIEZAS

DESPIECE DISPONIBLE

REF.	DESCRIPCIÓN				€
A 12955	TAS CARA PLANA Y CARA OVAL	0.28	-	25 99	27,80€
B 12956	TAS DE RAIL	0.31	-	25 99	27,80€
C 12957	TAS CON CARA OVAL	0.37	5	25 99	27,80€
D 12958	TAS MANGO CON CUÑA	0.41	-	25 -	27,80€
E 12959	TAS EN COMA	0.30	5	25 99	27,80€
F 12960	TAS DE TACÓN	0.18	-	25 1500	27,80€
G 12961	TAS DE COMA CON MANGO	0.34	-	25 -	27,80€



51131

61,00€

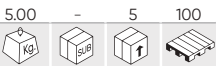

SET MARTILLOS ESPECIAL PARA CHAPA

DESPIECE DISPONIBLE

REF.	DESCRIPCIÓN				€
A 11541	MARTILLO DE BOCA PLANA	0.43	5	25 -	11,00€
B 11542	MARTILLO PLANO PEÑA	0.38	5	25 -	11,00€
C 11543	MARTILLO PLANO CÓNICO	0.42	5	25 -	11,00€
D 11544	TAS DE TACÓN	0.69	5	25 -	7,00€
E 11545	TAS DE ALETA	0.79	5	25 -	11,00€
F 11546	TAS DOS CANTOS ROMO	0.81	5	25 -	12,00€
G 11547	TAS DE CUÑA EN B O CARRIL	0.81	5	25 -	12,00€



53545

35,70€

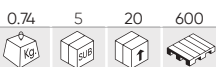

SET DE 5 VASOS 3/8" HEXAGONALES EXTRALARGOS



8, 10, 12, 13, 14mm (120mmL)

51832 18,00€

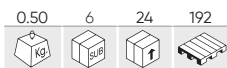

SET DE 4 PALANCAS DE NYLON TIPO CUCHILLA



19mm x 273mm
22mm x 273mm
25mm x 273mm
38mm x 273mm



50903 30,80€



SET DE 5 PALANCAS DE METAL



60, 61, 38, 28, 18cm



52026 31,80€



SET DE 2 PALANCAS DE METAL



51360 8,05€



PALANCA EUROPEA CON GANCHO 18"X5/8

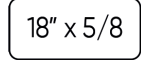

51361 9,80€



PALANCA EUROPEA CON GANCHO 24"X3/4

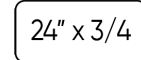

52851 9,65€



SET DE 2 PALANCAS PARA EXTRACCIÓN DE GRAPAS



53110 27,30€



SET DE 6 PALANCAS

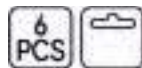

5"x8.5mm
5"x10.3mm
5"x4.5mm
15"x8.5mm
15"x10.3mm
15"x4.5mm

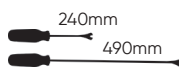

50901 16,00€



SET DE 5 PALANCAS DE NYLON

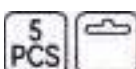

UNIVERSAL
60x160mm
63x175mm
30x200mm
20x180mm
20x215mm



52788 39,00€



SET DE 27 PALANCAS DE NYLON



CARROCERÍA

52977

137,00€

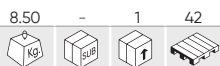

ESTUCHE DE 4 PALANCAS EXTRALARGAS



52540

221,00€



VENTOSA NEUMÁTICA PARA ABOLLADURAS



54017

12,00€



HERRAMIENTA DE CALAFATEO DE SILICONA

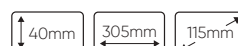

INCLUYE 5 ALMOHADILLAS DE SILICONA REEMPLAZABLES: 3R, 6R, 10R, 13R, 17R



52533

10,00€



PISTOLA DE SILICONA PROFESIONAL

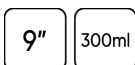

53525

12,00€



ÚTIL DE BLOQUEO PARA RESORTE DE GAS



- Diámetro de apertura máximo: 10mm.

53655

12,00€



LLAVE PARA MANIJA DE PUERTAS VAG



54246

104,00€



BALANZA DE PRECISIÓN 5KG

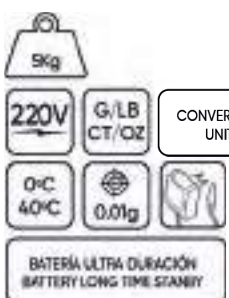

54247

99,00€



BALANZA DE PRECISIÓN 2KG

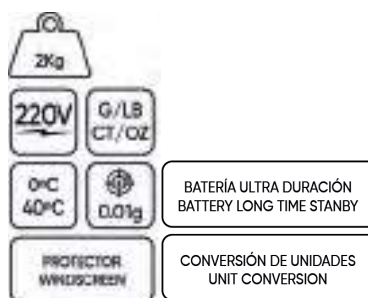

53230

19,70€

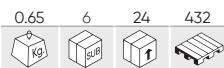

JUEGO DE ÚTILES PARA ABRIR COCHES

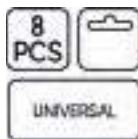

52077

29,50€



SET DE 4 ALMOHADILLAS HINCHABLES

40-50mm

CONTIENE

Almohadilla de 16x16cm
Almohadilla de 32x12cm
Almohadilla de 19x6cm
Almohadilla de 18x4,5cm
Bomba de mano

- Presión máxima soportada: 100kg.



53486

29,30€



PANTALLA PARA INSPECCIÓN DE ABOLLADURAS

Ø 800mm



53673

80,00€

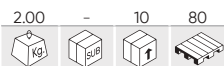

KIT DE RESTAURACIÓN DE FAROS

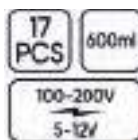

15375

28,00€

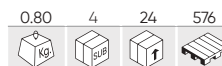

BOTELLA DE LÍQUIDO PARA REF. 53673

Polímero líquido que al evaporizarse permite restaurar los faros que hayan sido dañados debido a inclemencias climatológicas, proporcionando un brillo y acabado perfectos.



BRILLO Y ACABADO PERFECTOS

DESPIECE DISPONIBLE

REF.	DESCRIPCIÓN	kg	SUB	cm	cm	€
A	14564 SET DE 6 PAPELES DE LIJA PARA REF. 53673	0.10	10	100	9,20€	
B	14565 ENCHUFE TOMA CORRIENTE PARA REF. 53673	0.20	10	50	26,70€	
C	14566 ENCHUFE TOMA MECHERO PARA REF. 53673	0.05	10	100	16,70€	
D	14567 TAZA VAPORIZADORA PARA REF. 53673	0.15	10	20	38,00€	
E	14568 TAPÓN DE PLÁSTICO CURVADO PARA SALIDA DE GAS 53673	0.01	10	200	9,20€	
F	14569 TAPÓN Y TUBO DE PLÁSTICO PARA SALIDA DE GAS REF. 53673	0.00	10	200	9,20€	
G	14570 EMBUDO DE PLÁSTICO PARA REF. 53673	0.01	10	200	4,05€	
H	14571 PLACA DE LIJAR PARA REF. 53673	0.05	-	10	9,20€	
I	14573 CINTA DE PINTOR PARA REF. 53673	0.01	10	100	4,05€	
J	15375 BOTELLA DE LÍQUIDO PARA REF. 53673	0.80	4	24	28,00€	

BOLSAS DE 10 PAPELES DE LIJA

REF.	DESCRIPCIÓN	kg	SUB	cm	cm	€
14710	GRANO 180	0.25	10	100	3,50€	
14711	GRANO 280	0.20	10	100	3,75€	
14712	GRANO 360	0.20	10	100	4,00€	
14713	GRANO 600	0.15	10	100	4,25€	
14714	GRANO 800	0.15	10	100	4,50€	
14715	GRANO 1200	0.10	10	100	4,75€	



TUTORIAL DE USO

CARROCERÍA

52740

690,00€

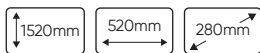
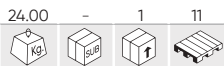

ALINEADOR DE FAROS CON LUXÓMETRO 152CM



HALÓGENO / XENON / LED

También para camiones.
Distancia de medición: 50cm.
Fácil medición de la desviación del eje óptico de la luz de carretera y de la luz de cruce.

52836

1.100,00€



ALINEADOR DE FAROS DOBLE LÁSER



HALÓGENO / XENON / LED

También para camiones.

DOBLE LÁSER
LUXÓMETRO DIGITAL
REGULACIÓN PANTALLA DE VERIFICACIÓN

53626

18,00€



KIT DE PULIDO DE FAROS



CONTIENE

- | | | | |
|--|-------------------------------|--|--------------------------|
| | x2 P800 Disco para lijar | | x1 85g Pasta Pulidora |
| | x2 P1200 Disco para lijar | | x1 Cinta adhesiva |
| | x2 P2000 Disco para lijar | | x1 Disco Pulidor de Lana |
| | x2 3.0ml Líquido protector UV | | x1 Disco Esponja Blanco |
| | x2 Adaptador (3/8" & 1/4") | | |

EN EXPOSITOR DE 12 UNIDADES



SERIE262

199,00€



KIT ESPECIAL PULIDO: PULIDORA + 12 KIT DE PULIDO DE FAROS

53626

x12u.



53646

x1u.



53729

19,10€

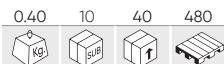

SET DE PUNTAS PARA AJUSTE DE FAROS

H6, H7, T25



300mm



52262

7,50€

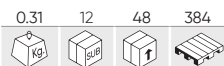

VENTOSA UNITARIA Ø 115MM

40Kg
ø 115mm



52263

13,50€



VENTOSA DOBLE Ø 115MM

70Kg
ø 115mm



52264

18,60€

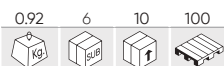

VENTOSA TRIPLE Ø 115MM

100Kg
ø 115mm



52265

30,50€



VENTOSA CUÁDRUPLE Ø 115MM

120Kg
ø 115mm



52295

6,50€

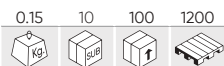

SET DE 2 MINI VENTOSAS Ø 60MM

5Kg
ø 60mm



52765

21,70€

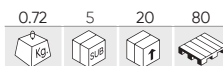

VENTOSA DOBLE ARTICULADA Ø 120MM

80Kg
ø 120mm



52998

48,00€



CONJUNTO DE VENTOSAS Y CORREA CON TRINQUETE 5M X 25MM

80Kg
ø 120mm
5x25mm



53232

39,00€

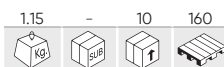

HERRAMIENTAS PARA SUSTITUCIÓN DE LUNAS

7 PCS

CONTIENE

- 1x útil extractor de molduras.
- 1x palanca para extraer la goma.
- 1x gancho extractor.
- 1x 1.8m de alambre de corte.
- 2x mangos para el alambre de corte.
- 1x pasa-cables.



13813

7,00€



CABLE PARA EXTRACCIÓN DE PARABRISAS

PARA REF. 53232



13814

11,00€



EMPUÑADURAS PARA LA EXTRACCIÓN DE LUNAS

PARA REF. 53232



CARROCERÍA

52321 8,80€



CINTA DE SUJECCIÓN CON TENSOR 5M X 25MM

5mx25mm



52327 12,00€



CINTA DE SUJECCIÓN CON TENSOR 8M X 25MM

8mx25mm



50577 12,60€



ALICATE MORDAZA PRESIÓN

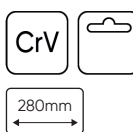

52386 23,60€



ALICATE PICO DE LORO CURVADO - PICO LISO



52385



JUEGO DE 6 ALICATES MORDAZA

251,00€

W (195mm)



JJ (195mm)



LL (195mm)



J (210mm)



T (215mm)



L (225mm)



ALICATES DE MORDAZA

REF.	DESCRIPCIÓN								€
53675	ALICATES DE MORDAZA RECTA	10"	250mm	70mm	0.75	10	20	300	50,00€
53676	ALICATES DE MORDAZA CURVA	10"	250mm	90mm	0.85	10	20	300	44,00€
53677	ALICATES DE MORDAZA CURVA CON PLETINA ARTICULADA	10"	250mm	80mm	0.90	10	20	300	55,00€
53678	ALICATES DE MORDAZA DE CURVA LARGA	10"	300mm	105mm	0.90	10	20	300	52,00€



53675



53676



53677



53678



EN EXPOSITOR DE 10 UNIDADES

52982







KIT DE 3 ALICATES DE MORDAZA EXTRALARGAS

53,00€



MORDAZAS

REF.	DESCRIPCIÓN	mm	MATERIAL		T					€
52390	MORDAZA ESPECIAL SOLDADURA	250mm	CrMo	-	-	0.50	5	40	640	35,20€
52474	MORDAZA ARGOLLA 5T	190mm	Hierro Fundido	0-20mm	5T	3.49	-	5	1500	68,00€
52475	MORDAZA PLANA 3T	170mm	Acero	0-25mm	3T	3.60	-	10	1500	62,00€
52476	MORDAZA CUADRADA 5T	220mm	Acero	0-25mm	5T	3.10	-	10	1500	50,00€
52477	MORDAZA PINZA 2T	200mm	Acero	0-60mm	2T	2.65	-	6	1500	70,00€
52478	MORDAZA 90° 5T	170mm	Acero	0-20mm	5T	2.90	-	10	1500	49,00€
52479	MINI MORDAZA PLANA 90° 3T	155mm	Acero	0-20mm	3T	1.18	-	30	1500	24,70€
52480	MINI MORDAZA CUADRADA 90° 3T	210mm	Acero	0-25mm	3T	2.00	-	10	1500	44,00€
52481	MORDAZA CUADRADA 3T	220mm	Acero	0-20mm	3T	2.05	-	10	1500	52,00€
52482	MORDAZA PLANA 45° 5T	210mm	Acero	0-10mm	5T	2.13	-	8	1500	44,00€
52483	MORDAZA PLANA MINI 5T	210mm	Acero	0-10mm	5T	2.02	-	12	1500	41,00€
52484	UNIÓN DE CADENAS 3T	275mm	Hierro Fundido	0-110mm	3T	1.19	-	11	1500	66,00€
52485	UNIÓN GANCHOS 4T	270mm	Acero	0-90mm	4T	1.17	-	30	1000	51,00€
52486	UNIÓN CADENA GANCHO 3T	280mm	Hierro Fundido	0-110mm	3T	1.21	-	11	1500	62,00€
52487	MORDAZA PINZA 5T	220mm	Acero	0-20mm	5T	2.27	-	7	1000	63,00€
52502	MORDAZA DE SOLDADURA	280mm	CrMo	0-110mm	-	0.84	10	30	540	31,40€
52503	MORDAZA DE SOLDADURA CON PLETINA	280mm	CrMo	0-105mm	-	0.85	10	30	540	32,50€
52504	MORDAZA DOBLE PATA	225mm	CrMo	0-50mm	-	1.14	-	30	480	27,60€
52505	MORDAZA DE BLOQUEO	170mm	CrMo	0-40mm	-	0.27	36	72	2160	20,80€
52506	MORDAZA BLOQUEO CON PLETINA	170mm	CrMo	0-50mm	-	0.28	36	72	2160	16,00€
52507	MORDAZA BOCA PLANA	250mm	CrMo	0-80mm	-	0.77	5	30	420	30,10€
52511	MORDAZA DE SOLDADURA 18"	440mm	CrMo	0-225mm	-	1.31	-	20	280	42,00€
52512	MORDAZA DE SOLDADURA CON PLETINA	440mm	CrMo	0-210mm	-	1.31	-	20	280	50,00€



53983

215,00€

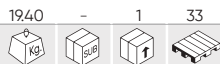

CARRO PORTA PIEZAS - PARABRISAS Y CAPÓ



12 BARRAS CUBIERTAS DE ESPUMA EPE (630MM)

BARRAS REGULABLES INDEPENDIENTES

RUEDAS DE PU DE 4 X 4 PULGADAS (DOS GIRATORIAS CON FRENO)

53125

477,00€



CARRO PARA ALMACENAJE DE PIEZAS



x4 INCLUIDOS

53124

287,00€



MEDIDAS ALTO



MEDIDAS LARGO



CABALLETE UNIVERSAL TELESCÓPICO



50923

454,00€



CARRO TRANSPORTADOR ESPECIAL PLANCHA 340KG



- Separación de 0 a 110cm.



REF.	DESCRIPCIÓN	194	-	10	1500	33,70€
12022	RUEDA DE RECAMBIO PARA REF.50923	194	-	10	1500	33,70€

53080 99,00€



CABALLETE PARA LUNAS DE COCHE



52749 79,00€



CABALLETE PLEGABLE PARA CHAPISTA



REF.	DESCRIPCIÓN		€
11959	SET DE 2 ESPUMAS PARA CABALLETE REF. 52749	0.08 100	10,50€

53079 89,00€



CABALLETE EN "X"



53736 98,00€



CABALLETE SOPORTE PARACHOQUES



ANCHURA AJUSTABLE PERMITE QUE EL SOPORTE SEA ADECUADO PARA SOSTENER PARACHOQUES

ANCHURA AJUSTABLE: 75 CM -160CM

ALTURA MÁXIMA: 148CM

ACERO

53685 310,00€



SOPORTE PARA PARACHOQUES



AJUSTE DE LOS BRAZOS DE APOYO DE 134 - 198CM

4 RUEDAS DE 4 PULGADAS (DOS GIRATORIAS CON FRENO)

ACERO CON RECUBRIMIENTO DE POLVO

53134 144,00€



SOPORTE PARA PINTURA AJUSTABLE



- 6 ganchos para sujetar piezas para pintar o secar.
 - Marco ajustable que se extiende de 127cm a 203cm.

53126 243,00€



SOPORTE BASCULANTE PARA PINTURA



6 BRAZOS DE SUJECIÓN:
 4 CON GANCHO FIJO
 2 CON AGUJERO

52230

398,00€

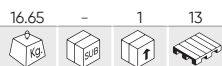

PLATAFORMA DE ALUMINIO TELESCÓPICA

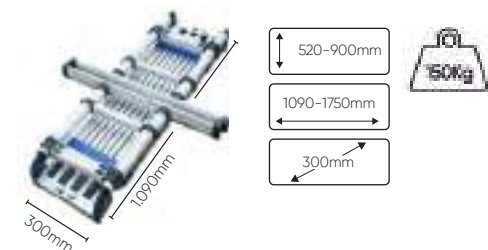

REF.	DESCRIPCIÓN	KG	SUB	1	13	€
10964	PROTECTOR DE ESQUINA PARA PLATAFORMA (REF.52230)	0.01	-	1	-	9,00€
10965	TOPE DE ESCALÓN PARA PLATAFORMA (REF. 52230)	0.01	-	1	-	6,00€
10966	PIE RECAMBIO PARA PLATAFORMA (REF.52230)	0.06	-	1	-	13,50€

CUMPLE CON: EN 131



50913

195,00€

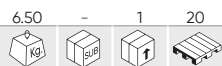

PLATAFORMA DE ALUMINIO GRANDE



CUMPLE CON: EN 131

50656

290,00€



JUEGO DE 2 PLATAFORMAS DE ALUMINIO



CUMPLE CON: EN 131

REF.	DESCRIPCIÓN	KG	SUB	1	10	€
11897	100x30x30cm	4.66	-	1	16	155,00€
15552	130x30x55cm	6.80	-	1	18	181,00€

53922

29,00€



PORTABOBINA DE PAPEL PARA PARED

- Material: acero inoxidable
- Rollo: Ancho máx. de 38 cm.
- Sierra de plástico ABS gris.
- Montaje con tornillo y tuercas de acero inoxidable.

PAPEL NO INCLUIDO



53921

39,00€



PORTABOBINA DE PAPEL

- Material: Acero inoxidable.
- Rollo: Máx. ancho 38 cm.
- Sierra de plástico ABS.

PAPEL NO INCLUIDO



SET DE EXPOSITOR + MATERIAL DE CUIDADO DEL VEHÍCULO

50400 168,00€

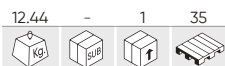

CONTIENE

- 53705 EXPOSITOR
- 51978 ROLLO DE FUNDAS
- 52057 ROLLO DE FILM CUBREVOLANTE
- 52058 MANGO PARA ROLLO DE FILM
- 50409 FUNDA POSAPIÉS ANÓNIMA EN PAPEL

50403 98,00€

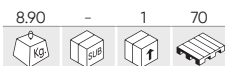

CONTIENE

- 52065 EXPOSITOR
- 51978 ROLLO DE FUNDAS
- 52057 ROLLO DE FILM CUBREVOLANTE
- 52058 MANGO PARA ROLLO DE FILM

50410 168,00€



CONTIENE

- 53705 EXPOSITOR
- 52244 ROLLO DE FUNDAS
- 52057 ROLLO DE FILM CUBREVOLANTE
- 52058 MANGO PARA ROLLO DE FILM
- 50409 FUNDA POSAPIÉS ANÓNIMA EN PAPEL

EXPOSITOR DE PARED DE BOBINA CUBREASIENTO, ROLLO VOLANTE Y POSAPIÉS

53705 80,00€

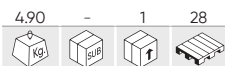

51985 84,00€

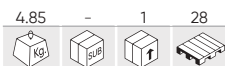

52065 45,00€



51978 84,00€



ROLLO DE FUNDAS DE PROTECCIÓN 25MC 250UDS.



52244 84,00€



ROLLO DE FUNDAS DE PROTECCIÓN MODELO DIBUJO ANÓNIMO 25MC 250U.



52057 6,80€



ROLLO DE FILM CUBREVOLANTE

23 mc - Largo: 200m - Anchura: 12,5cm - Espesor: 23mc

52058 4,50€



MANGO PARA ROLLO DE FILM REF. 52057



REF. 52057

REF. 52058

CARROCERÍA

50409

26,00€

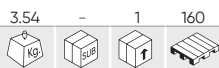

FUNDA POSAPIÉS ANÓNIMA EN PAPEL

250 PCS



51824

36,80€



PROTECTOR DE VOLANTE PLÁSTICO 250 UNIDADES

250 PCS



50916

0,88€

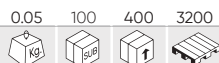

KIT DE MANTENIMIENTO EN BOLSA INDIVIDUAL

5 PCS 20 mc

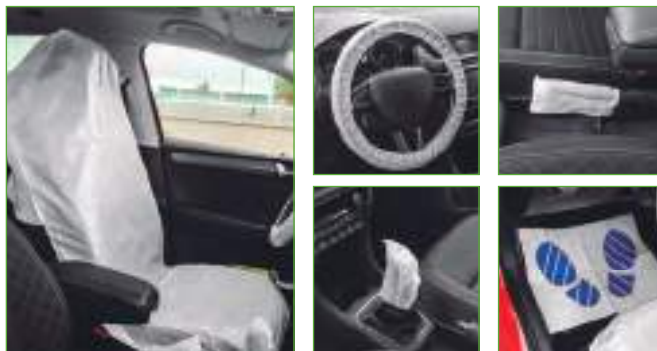

53226

14,90€

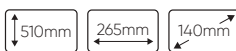
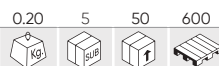

FUNDA DE ASIENTO COCHE



- UNIVERSAL
- DE NYLON

51622

25,30€



PROTECTOR MAGNÉTICO CUBRE ALETAS Y FRONTALES



4 PUNTOS IMANTADOS

DOS CARAS:
UNA ATERCIOPELADA Y UNA PLÁSTICA

BARRA EXTENSIBLE MULTIFUNCIÓN

REF.	Max.	Min.					€
52497	1200mm	530mm	0.29	6	48	480	26,80€
53196	1600mm	710mm	0.37	6	48	384	33,00€



FRENOS

194 REPOSICIONADORES

197 SANGRADORES

197 MANTENIMIENTO



52636

114,00€

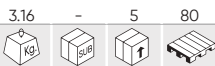

16 PCS

KIT REPOSICIONADOR PARA PISTONES DE FRENO CON PISTOLA 16 PCS

- 0 General Motors (Ø pistones 2-1/2")
- 2 Citroën XM/Xantia (F/R), HONDA
Audi (F), Fiat, Alfa romeo (F), Ford Fiesta (F), Isuzu (F), Honda Concesto (F), Jaguar XJ6/ XJ40 (F/R), BMW 318is / 320i / 325T / 518i / 525i-1x / 740i / 850ci / M5 (F), Mercedes BENZ 190/200/300/420/560 serie (F), Mitsubishi Colt (F), Nissan Miera/Stanza/Sunny (F), Rover Austin/Metro200-400 series/Maestra/Montego (F), Toyota Camry (F), Volvo (F), VW Passat/Golf GTI (F)
- 4 Ford Australia/NZ Telstar, Mazda (R), Saab 9000 (R)/Lumina, Toyota, Fiat 164 2.0 (R), Alfa Romeo Prelude/CRS 16i, Honda Saturn (R)/Grand Prix, GM
- 5 Adaptador 3/8"
- 6 Nissan Primera, VW Golf IV
Audi 80/90/V8+100/Coupe E (R), Rover 800 ABS, Subaru L+Z (R), Ford Sierra ABS/Granada/Scorpio ABS (R), Nissan Bluebird 1.8 Turbo/Silvia Turbo/Primera2.0i LS-GS-GSX (R), Peugeot 405 1.9Gi/Grii/Sri/Gtxi/Mi 16/605 2.0 Sri (R), Toyota Cecilia/Corolla GT/MR2 (R), VW Golf Gti/Jeta Synchron/Jetta Gti 16v, Passat CL, GL, GT, GT 16v, Corrado 16V scirocca GTX 16V(R), Citroën, Alfa romeo, Fiat, Honda, Jaguar, Renault, Saab, Seat, Lancia.
- 7
- 8 General Motors (Ø pistones 1-7/8")
- 9 General Motors (Ø pistones 2-1/8")
- A(Z) Renault (R21-Laguna (R))
- E Nissan Maximas/Cefiro
- F(G) Opel (Rear disk)/ Fiat Stilo
- K Citroën C5
- K1 Renault, Citroën C5

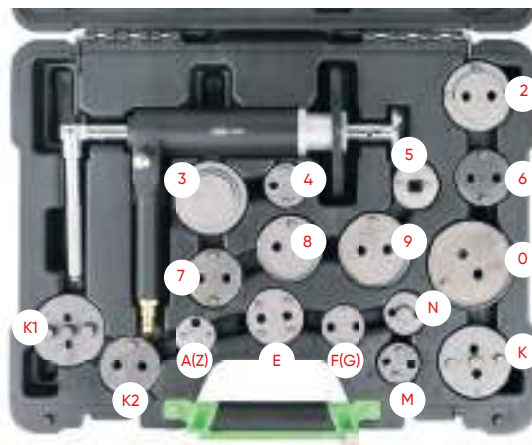

- K2 Renault, Citroën, Audi A8, S8
- M Ford, Mini Cooper, Nissan Primera 03
Saab, Honda, Alfa Romeo 164 2.0 Twin Spark/2.0 Turbo (88-)/3.0 V6, Audi 200 (80-)/Coupe GT SE (82-)/80/90/1QO/200/Quattro (87-)/90/20V (88-), Ford Mondeo 2.0/Ghia, Lancia Themaalte (85-), Volkswagen Golf II GTI (83-87)/Sirocco 16V (84)
- N

52330

99,00€



50 PCS OPEL PEUGEOT CITRÖEN RENAULT

REPOSICIONADOR PARA PISTONES DE FRENO 50 PCS

- 0 General Motors (Ø pistones 2-1/2")
- 1 Disco
- 2 Citroën XM, Xantia u.a.
- 3 Alfa Romeo,Audi, Austin, BMW, Ford, Honda, Jaguar, Mercedes-Benz. Mitsubishi, Nissan Rover, Toyota, VW
- 4 Alfa Romeo 164 2.0.Ford, Mazda, Saab 9000, Subaru
- 5 Adaptador 3/8"
- 6 Nissan Primera, VW-Golf IV
- 7 Audi 8.0,90,V8 +100, Ford Sierra ABS+ Scorpio ab 85, Honda Prelude, Nissan Silvia 1.8 turbo, Rover 8000, Saab 9000, Subaru L+Z, VW-Golf+ Passat
- 8 General Motors (Ø pistones 1-7/8")
- 9 General Motors (Ø pistones 2-1/8")
- 11 Disco para Jaguar tipo S
- 12 Disco para BMW mini
- A Nissan Premira 2.0, Bluebird
- A1 Ford Transit 06,Transit Connect 02,Tourneo Connect 02,Mondeo 00-07,C-Max 03, Focus 04
- B Ford, Lincoln, Subaru
- B1 Ford S-max 06,Scorpio 94-06,Mondeo 07,Kuga 08,Galaxy 00-06,Focus RS 03,Fiesta 01-02,Cougar 98-01
- C Nissan Primera (02), Opel Vectra 02-,Toyota Avensis
- D Citroën, Renault
- E Cefiro, Maxima
- F Peugeot 206 CC/Hdi/Gti. Requiere una llave de 16mm con pistones traseros.
- F1 Fiat Ducato
- G Opel
- G1 Volkswagen Golf V / VI
Alfa Romeo 155 1.8-2.0 164 TD(93) 164 3.0 V6(91), Audi 80,90,A3,A4,A6,A8, Citroen ZX 2 Ql 16V, Fiat Tipo TD 16V, Uno Turbo (85) Crama TD, Ford Sierra (ABS bak). Granada (85) Crama TD, Ford Sierra (ABS bak). (Australia& NZ) Thunderbird Turbo, Honda CRX, 1.6i-16V (8-90), Accord 1800 (84-85) 2.0i, Prelude 16V (88), Legend V6, Jaguar XJ 4, Oseries, Lancia Dadra 2.0, Ei Tur (93), Delta 1.6 Gti, Nissan, Peugeot, Renault, Seat, Subaru, Volvo V40 6S40.
- J
- K Citroën C5
- K1 Citroën
- K2 Citroën, Renault.
- M Ford
- N Saab, Honda
- O Disco

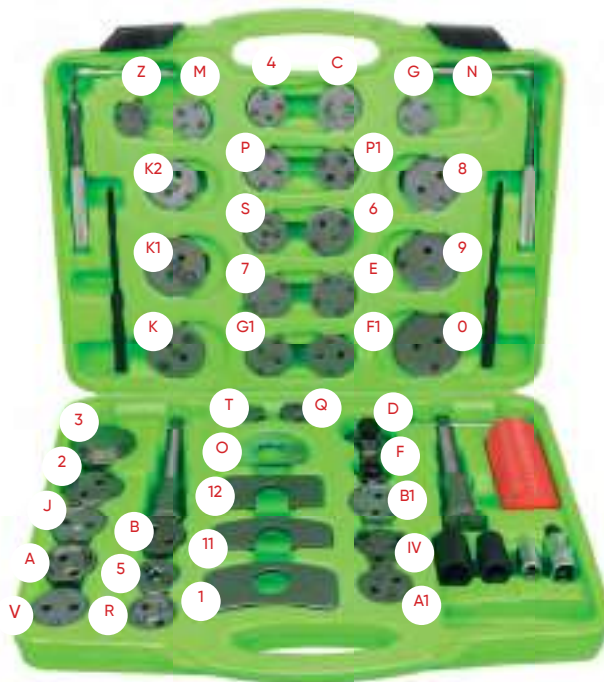

- P Audi, BMW, Ford, Lancia, Piston, Renault, Rover.
- P1 Peugeot 307,308.
Alfa Romeo 164 2.0 1., Fiat Uno, Turbo ie-Barchetta, Ford Escort MK III, IV, Orion, XR31, Focus(98-) push-back pistons, Honda-most models (push-back pistons), Rover-most models(push-back pistons), Subaru Lserie & Serie 2
Ford(Australia& NZ) Teslar, Laser, Mazda 323 Gti, GTXX (86), 929 (82.), RX7(81-), 626
R 16V(87-) 626 GT (86-), 929 V6 (88-), Mitsubishi Galant GL Si, Toyota Celica, Corolla GT, MR2
Audi 100 TQ(91), BMW 740i 8cyl (91), Lancia Delta 1.9 TD (95), Proton 416, Renault-most models, Renault Laguna 2.0 (94), Laguna 2.2 D (95) Safrane 2.0-2.2 TD V6, Rover 623 Si, Volkswagen Golf Gtu Mk I&IV, Passat VR6, Vento GT (92)
- S
- T Rover 220 C Turbo (95)
- V Rover 216 Gti 16V,820 Si 2.0(93),825 SD 2.5 (93)
- Z Renault
- IV Iveco Daily, Volkswagen Passat 2.0 TDI 09-

53978

38,90€

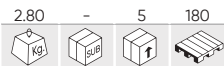

23 PCS

REPOSICIONADOR PARA PISTONES DE FRENO 23 PCS

- 0 General Motors (Ø pistones 2-1/2")
- 1 Disco
- 2 Citroën XM, Xantia
- 3 Alfa Romeo, Audi, Austin, BMW, Ford, Honda, Jaguar, Mercedes-Benz, Mitsubishi, Nissan, Rover, Toyota, VW
- 4 Alfa Romeo 164 2.0, Ford, Mazda, Saab 9000, Subaru
- 5 Adaptador 3/8"
- 6 Nissan Primera, VW.Golf IV
- 7 Audi 80;90;V8+100, Ford Sierra ABS+Scorpio de 1985, Honda Prelude, Nissan Silvia 1.8 turbo, Rover 8000, Saab 9000, Subaru L+Z, VW Golf + Passat
- 8 General Motors (Ø pistones 1-7/8")
- 9 General Motors (Ø pistones 2-1/8")
- 10 VW K1 Citroën
- A Renault R21, Laguna K2 Citroën
- E Nissan Maxima, Cefiro M Ford
- F Opel N Saab, Honda
- K Citroën C5 O Disco

J Fiat Tipo TD 16V, Uno Turbo(85) Crama TD, Honda CRX, Alfa Romeo 155 1.8-2.0i, 164 TD (93), 164 3.0 V6 (91); Audi 80, 90, & V8's, A3, A4, A6, A8 (pinza trasera); Citroën ZX 2. Ql 16v; Fiat Tipo TD 16V, Uno Turbo (85-), Crama TD; Ford Sierra (ABS bak), Granada (85-); Ford (Australia & NZ) Thunderbird Turbo; Honda CRX, 1.6i-16V (88-90), Accord 1800 (84-85), 2.0i (86-), Prelude 16V (88-), Legend V6; Jaguar XJ serie 40; Lancia Dedra. 2.0 Ei Tur(93), Delta 1.6 Gti. (92), The. majE 16v(92), Thema. 2000 Turbo. Kappa 2.Q-2.4LS, 2.4TD;



J Nissan 280 ZX (82-84), 300 ZX Turbo (84-89), Bluebird 16V (89-), Silvia 1.8 Turbo (85-88) 100 NZ 2.0 (93), Primera 2.0 GT (94), 200 SX turbo 16V, Maxima 2. O GX-3.0 GX (95); Peugeot 306; Peugeot 309 Gtj 16S (91), 405. Srif Q. rj, Gil (87-), 405 M.1 16v; Renault Master Van; Rover 216 Gti 16V, 820 Si 2. 0(93), 825 SD 2.5 (93); Saab 9000 CS 2.0(93), 9000 CSE Turbo(93); Seat Toledo GT. 16V-GT 2.0(93), Lbiza 1.8 Gti 16V(95); Subaru Lserie & Serie 2; Volkswagen Passat 2.0 & 2.2 Litre(84), Golf Rallye (-89), Golf II Gti 16V(89-), Vento GT (92), Transporter T4; Volvo S40 & V40

51059

99,00€



37 PCS

REPOSICIONADOR PARA PISTONES DE FRENO 37 PCS

- 0 Disco
- 1 Disco
- 2 Citroën XM, Xantia (F/R)
- 3 Alfa Romeo, Audi, Austin, BMW, Ford, Honda, Jaguar, Mercedes-Benz, Mitsubishi, Nissan, Rover, Toyota, VW.
- 4 Alfa Romeo 164 2,0,Ford,Mazada,Saab 9000,Subaru.
- 5 Adaptador 3/8"
- 6 Nissan Primera,VW-Golf IV.
- 7 Audi 80,90,V8 +100,Ford Sierra ABS+Scorpio ab 85,Honda Prelude Nissan Silvia 1.8 turbo,Rover 8000, Saab 9000, Subaru L+Z, VW-Golf +Passat.
- 8 General Motors (Ø pistones 1-7/8")
- 9 General Motors (Ø pistones 2-1/8")
- 11 Disco para Jaguar tipo S
- 12 Disco para BMW mini
- A 1-3/16" Disco de dos clavijas para Renault R21, Laguna
- B Ford, Lincoln, Subaru.
- C Mini Austin
- D Citroën, Renault.
- E Cefiro, Maxima
- F Opel Corsa, Astra, Zafiraand Vectra
- G Opel (disco trasero)
- H Alfa Romeo 155 1.8-2.0 164 TD(93) 164 3.0 V6(91) Audi,80,90,A3,A4,A6,A8 Citroen ZX 2 Ql 16V,Fiat Tipo TD 16V,Uno Turbo(85) Crama TD, Ford Sierra(ABS bak),Granada (85),(Australia & NZ) Thunderbird Turbo,Honda CRX,1.6i-16V (8-90),Accord 1800(84-85)2.0i,Prelude 16V(88),Legend V6,Jaguar XJ40series,Lancia Dedra 2.0 Ei Tur(93),Delta 1.6Gti,Nissan,Peugeot, Renault,Seat,Subaru,Volvo V40& S40.
- K Citroën C5
- K1 Citroën, Renault.
- K2 Citroën, Renault.
- M Ford
- N Saab,Honda. Z: Renault
- O GM Motors.
- P Audi, BMW, Ford, Lancia, Proton, Renault, Rover, VW
- R Ford (Australia & NZ) Telstar,Laser, Mazda 323 Gti,GTX(86-),929(82-),RX7(81-),626 16V (87-), 626 GT (86-),929 V6(88-),Mitsubishi Galant GL Si, Toyota Celica,Corolla GT,MR2. Audi 100TQi(91), BMW 740i 8cyl.(91), Lancia Delta 1.9 TD(95), Proton 416, Renault-most models, Renault Laguna 2.0 (94), Laguna 2.2 D(95), Safrane 2.0-2.2 TD V6, Rover 623 Si, Volkswagen Golf Gti Mk 3&4,Passat VR6,Vento GT(92).



Z BMW, Mini
 Pinza de rotación derecha (con rosca a la derecha)
 Pinza de rotación izquierda (con rosca a la izquierda)
 Pin Ø 3.0 / Pin Ø5.5 (100g Grasa)

52906

38,00€



SET REPOSICIONADOR DE FRENOS UNIVERSAL



REF. DESCRIPCIÓN

REF.	DESCRIPCIÓN	1.30	5	500	€	
12974	RECAMBIO 2 PINS PARA REF.52906	0.50	-	50	1500	21,00€
12975	RECAMBIO 3 PINS PARA REF.52906	0.17	-	50	-	23,00€



ALFA ROMEO 164 2.0, FORD, MAZDA, SAAB 9000, SUBARU, NISSAN PRIMERA, VW, AUDI, FORD SIERRA ABS + SCORPIO AB 85, HONDA PRELUDE, NISSAN SILVIA 1.8 TURBO, ROVER 8000, SAAB 9000, FORD, OPEL, BMW, LANCIA, PROTON, RENAULT, ROVER, PEUGEOT 307, 308 A3- IVECO DAILY, VOLKSWAGON PASSAT 2.0 TDI 09, RENAULT LAGUNA.

53683

116,00€



PISTOLA REPOSICIONADORA DE FRENOS PERFIL BAJO

- Presión de trabajo: 5-8 BAR.
- Presión máxima: 14 BAR.
- Entrada de aire 1/4".
- Soporte de disco magnético.
- Compatible con discos de 2 y 3 pins.



51283

78,00€



PISTOLA REPOSICIONADORA DE FRENOS

- Presión de trabajo: 5-8 BAR.
- Presión máxima: 14 BAR.
- Entrada de aire 1/4".
- Soporte de disco magnético.
- Compatible con discos de 2 y 3 pins.



52191

198,00€

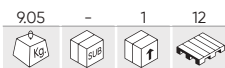

SANGRADOR DE LÍQUIDO DE FRENOS

5L

- Presión de trabajo: de 0 a 4 kg/cm².
- Aire de 1/2".
- Peso: 5Kg.
- Adaptadores: T1 + 2 universales.
- Aplic.: GM, Chrysler, Nissan.



REF. DESCRIPCIÓN

52328 TAPONES PARA SANGRADOR DE FRENOS PARA REF.52191

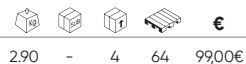

52434

125,00€

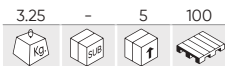

15 PCS

ESTUCHE PARA REPARACIÓN / MANTENIMIENTO DE FRENOS

- x2 Llaves de tuerca de freno
- x1 Alicates de muelle de freno
- x1 Destornillador de impacto
- x3 Vasos destornilladores
- x1 Herramienta de ensamblaje
- x1 Destornillador con articulación universal
- x1 Herramienta especial freno
- x1 Cepillo de limpieza
- x1 Cepillo de limpieza de latón
- x1 Herramienta de ensamblaje
- x1 Alicates de cable de freno
- x1 Lima para mordaza de freno



54135

82,00€

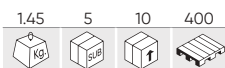

17 PCS

SET DE VASOS PARA PINZAS DE FRENO

CONTIENE

	x2	14x38, 22x38mm
	x3	11,50x38, 15x38, 20x38mm
	x4	10, 12.50, 14, 19mm
	x1	10mm
	x4	H11x100, H7x70, H7x92, H9x50mm
	x2	7x24, 8x24mm
	x1	9x20mm



AUDI (A4, A5, S5, S8, Q5, Q7), PORSCHE (CAYENNE, MACAN, CAYMAN), MERCEDES BENZ, FORD, BMW, ALFA ROMEO

54372

157,00€



N

JUEGO COMPROBADOR DE FRENOS CON Y SIN ABS

Diseñado para el desmontaje de las pinzas de freno cuando se realiza la sustitución de las pastillas de freno.

APLICACIONES

AUDI(TT (2007-), A4(2001-), A6(2005-), A8(2003-), Q7, S5, S6, S8), PORSCHE (CAYENNE, MACAN, CAYMAN), MERCEDES-BENZ (ML320, CLASE C), FORD (MONDEO, FIESTA, FOCUS, EDGE), BMW (SERIES 3 -GENERACIÓN E36 / 5), ALFA ROMEO, JAGUAR (XF), VAUXHALL, VOLKSWAGEN, CHRYSLER, MINI, SAAB



CONTIENE

- x1 Adaptador Teves
- x1 Adaptador giratorio 45
- x1 Adaptador giratorio de 90
- x2 Adaptador recto 7/16-24
- x2 Adaptador recto 1/4-28
- x2 Adaptador recto 3/8-24
- x2 Adaptador recto 5/16-24
- x2 Adaptador recto M10-1,5
- x2 Adaptador recto M8-1,25
- x2 Adaptador de purga M10-1.0
- x2 Adaptador recto 7/16-20
- x2 Adaptador recto M7-1.0

52625

9,00€



ALICATES PARA FRENO DE TAMBOR



- Para extraer e instalar resortes de retorno en frenos de tambor.

52315

16,00€



SEPARADOR DE PISTÓN Y FRENO



- Apertura máxima: 80mm.

51839

24,00€

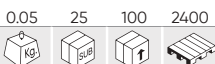

COMPROBADOR DE LÍQUIDO DE FRENOS

- Funciona a pilas 1xAAA LR03.
- Con 4 niveles de calidad medibles del 0% al 4%.



52455

16,00€

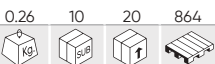

JUEGO DE GALGAS PARA PASTILLA FRENO



COLOR	METRIC	SAE
Green	8-10-12mm	0.3150-0.4720"
Yellow	4-5-6mm	0.1575-0.2382"
Red	2-3mm	0.0787-0.1181"

52275

38,00€



SANGRADOR DE FRENOS NEUMÁTICO



- Temperatura de trabajo: 10°C a 50°C.
- Manguera silicona: 2m.
- Pistola de soplado con entrada 1/4".
- Presión aire: 6-12 bar (87 - 174 psi).
- Consumo de aire: 180l/min.

UTILLAJE

- 200 SISTEMA DE LUBRICACIÓN
- 206 SISTEMA DE INYECCIÓN
- 213 BLOQUE/CULATA
- 216 EMBRAGUE
- 217 SISTEMA DE REFRIGERACIÓN
- 219 SISTEMA DE AIRE ACONDICIONADO
- 221 TRANSMISIÓN
- 223 SUSPENSIÓN
- 229 ESCAPE
- 231 SISTEMA ELÉCTRICO
- 235 REPARACIÓN DE ROSCAS
- 238 MOTO
- 238 EXTRACTORES



54068

120,00€



JUEGO DE EXTRACTORES PARA FILTROS DE ACEITE / 19 PCS EN ALUMINIO

REF.	Nº DE PIEZA	DESCRIPCIÓN	CANTOS x Ø				€
15494	05101	Mazda, Mitsubishi	15 x 100,5mm	0.18	-	50	12,50€
15495	0595	Nissan, Toyota	15 x 94,5mm	0.18	-	50	12,50€
15496	0592	Nissan, Subaru	15 x 92mm	0.18	-	50	11,50€
15497	0579	Toyota, Honda, Mitsubishi, Subaru, Mazda, Lsuzu	15 x 79mm	0.14	-	50	11,00€
15498	915	Volvo	16 x 87mm	0.24	-	50	11,50€
15499	901L	Lexus	14 x 79,5mm	0.15	-	50	11,00€
15500	901T	Toyota	14 x 70mm	0.13	-	50	10,00€
15501	901-1	Toyota	14 x 63-64mm	0.10	-	50	10,00€
15502	902	Ford, Mazda	14 x 66,5mm	0.89	-	50	10,00€
15503	1284	Dodge Sprinter (2007-), Mercedes Benz E320 (2007-), Jeep Cherokee 3.0L V6 Common Rail (2007-)	14 x 84mm	0.13	-	50	11,00€
15504	903B	Mercedes Benz	14 x 74mm	0.13	-	50	10,00€
15505	24mm	BMW 5, BMW 7, BMW X5 V8 (N62) (2004-), Saturn (2008), Astra 1.8L ECOTEC, Chrysler 3.6L V6 (2011-), 200, 300, T/C Dodge Jeep	6 x 24mm	0.47	-	50	4,00€
15506	27mm	Mercedes Benz Clase A	6 x 27mm	0.45	-	50	4,00€
15507	30mm	Audi A2, Vw Polo, Lupo 1.4L/1.6L	6 x 30mm	0.44	-	10	4,50€
15508	32,5mm	Opel Astra G, Corsa B, Zafira, Audi, VW 1-36 mm, Opel Omega, Vectra B, Zafira (98-), BMW M43/60)	6 x 32,5mm	0.45	-	50	4,50€
15509	36mm	Opel Omega, Vectra B, Zafira (98-), BMW M43/60, Mercedes Benz Vito CDI, C, E, VW Lupo 1.2 TDI, MAN	6 x 36mm	0.48	-	50	5,00€
15510	38mm	Opel Vectra 2.0D	6 x 38mm	0.50	-	50	5,00€
15511	917	Universal	55-90mm	0.22	-	50	8,00€



51332

98,00€



JUEGO DE EXTRACTORES PARA FILTROS DE ACEITE / 23 PCS EN ALUMINIO

REF.	Nº DE PIEZA	DESCRIPCIÓN	CANTOS x Ø				€
11374	901	Toyota, Nissan, Fiat Daihatsu	14 x 65mm	0.05	5	20	5,50€
11375	902	Toyota, Daihatsu	14 x 67mm	0.45	5	20	6,50€
11376	903	VW, Mercedes, BMW, Opel, Audi	14 x 74mm	0.20	5	20	5,50€
11377	903-1	GM/AC, Wix, Ford, Isuzu	15 x 75mm	0.09	5	20	5,50€
11378	903-2	VW, Audi, Seat, BMW, Renault	8 x 74mm	0.09	5	20	6,50€
11379	903-3	Audi, Rover, Chrysler	15 x 74mm	0.11	5	20	6,00€
11380	903-4	Toyota, Lexus	14 x 73mm	0.11	5	20	6,50€
11381	903-6	Schlepper, Baumashinen	12 x 75mm	0.10	-	20	6,50€
11382	918	Rover, Chrysler, Audi	15 x 74mm	0.11	5	20	6,00€
11383	904	Nissan, Ford	15 x 79mm	0.50	5	20	6,00€
11384	905	GM, Chrysler	15 x 73mm	0.12	5	20	6,00€
11385	905-1	BMW, Mercedes, Opel, Audi, VW	14 x 74mm	0.10	5	20	5,50€
11386	906	Baumashinen, Schlepper	18 x 84mm	0.10	5	20	6,00€
11387	907	Mitsubishi, Toyota	15 x 89mm	0.13	5	20	6,00€
11388	908	Nissan, Toyota	15 x 91mm	0.14	5	20	6,00€
11389	915	Honda Accord, Mitsubishi, Isuzu	15 x 90mm	0.16	5	20	6,00€
11390	910	Toyota, Alfa Romeo, Ford	15 x 95mm	0.12	5	20	6,00€
11391	911	Fiat, Renault, Citroën	12 x 76mm	0.09	5	20	6,50€
11392	911-1	Subaru, Toyota, Honda, Nissan	15 x 80mm	0.09	5	20	6,00€
11393	914	Mazda, Toyota	15 x 101mm	0.18	5	20	6,00€
11394	909	Isuzu, Nissan	15 x 92mm	0.14	5	20	6,00€

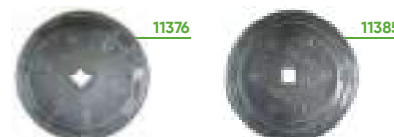

REF.	DESCRIPCIÓN				€
14992	LLAVE DE 12 CANTOS PARA REF.51332/REF.14141	0.14	-	100	8,50€
10955	CARRACA DE 1/2" PARA EXT. FILTROS 51332	0.14	-	50	11,00€

VASOS PARA FILTRO DE ACEITE

REF.	CANTOS x Ø	DESCRIPCIÓN					€
52311	42mm	GRUPO VAG	0.13	6	72	1728	19,00€
52312	14 x 74mm	VW, OPEL, MERCEDES, BMW, AUDI	0.10	10	100	1000	9,00€
52313	16 x 86mm	VOLVO 540, 560, 570, 580	0.20	6	68	1008	8,00€
52314	16 x 87mm	BMW, VOLVO	0.20	5	50	600	26,60€
52809	14 x 64,5mm	TOYOTA	0.15	10	100	1000	8,50€
53441	14 x 76mm	-	0.20	5	20	800	9,80€



53008

15,50€

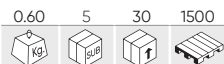

EXTRACTOR DE FILTROS DE ACEITE PARA FORD, CITROËN, PEUGEOT 2.0, 2.2 HDI, TDCI



52518

115,00€



EXTRACTOR DE FILTROS PARA CAMIÓN 95-165MM



52615

112,00€



SET DE 9 EXTRACTORES DE FILTROS DE ACEITE

9 PCS

- Llave de doble sentido ajustable.
- Rango de aplicación: 60-80mm.

1/2"	x1	Universal	63 - 83mm
		Mercedes Benz, Smart	27mm
	x3	GM, Opel, Vauxhall, Mercedes Benz	32mm
		Mercedes Diesel, BMW, Mini, Ford	36mm
		Toyota (Allion, Auris, Corolla, Prius, Voxy, etc.)	64,5mm
3/8"	x3	Toyota, Lexus (6 Zyl.).	64,5mm
		Audi, BMW, Ford, Toyota, Volkswagen, Porsche, Mercedes-Benz	74,2mm
	x1	Hunday, Kia.	88,8mm
	x1	BMW 3+5+X, Volvo	86,6mm



EXTRACTOR DE FILTRO DE ACEITE CON PATA REDONDA / PLANA

51352

9,80€



1/2" - 3/8"
57-118mm
Ø2-1/4" ~ 5"

51353

11,50€



1/2" - 3/8"
72-136mm
Ø2-1/2" ~ 4"

51923

12,50€



1/2" - 3/8"
72-136mm
Ø2-1/2" ~ 4"

51934

11,50€



1/2" - 3/8"
57-118mm
Ø2-1/2" ~ 4"

53206

38,20€



5 PCS

SET 5 VARILLAS PARA COMPROBACIÓN DE ACEITE PARA MERCEDES BENZ/AUDI

- Para comprobar el fluido de transmisión de aceite en los motores Audi 100:
 - La punta (primera 11 mm) es la lectura del fluido frío a 20 °C.
 - La segunda lectura es el mínimo a 80 °C.
 - La tercera lectura es a 80° C máximo.
- Mantenga el nivel del vehículo al revisar ATF.
- Varilla medidora del motor para comprobar el nivel de aceite, compatible con una gran selección de motores de 1988 a 2005 en la gama Mercedes.

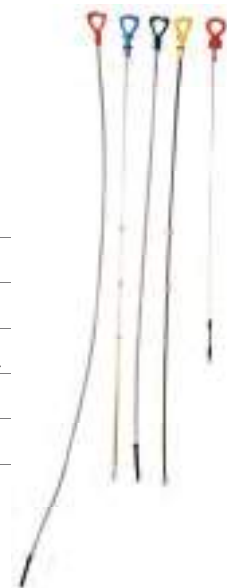

	Mercedes-Benz	920mm	- Código de la transmisión: 716.5.722.7722.8.
	Mercedes-Benz	930mm	- Año de la fabricación: 1988-1997. - Códigos de motor: 103.104.111.119.120.137.604.605.606.611.612.613.628.642.647.648.
	Mercedes-Benz	930mm	- Año de la fabricación: 1996-2005. - Códigos de motor: 03.104.111.112.113.119.120.137.271.272.604.605.606.611.612.613.628.642.646.647.648.
	Mercedes-Benz	1200mm	- Código de transmisión: 722.6.
	Audi	1160mm	- AUDI 100 motores

REF.	DESCRIPCIÓN					€
13856	VARILLA PARA COMPROBACIÓN DE ACEITE AUDI	0.04	5	100	-	7,80€

51354

13,20€



PINZA EXTRACTORA DE FILTROS DE ACEITE



53670

29,50€

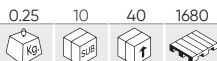

LLAVE PARA FILTRO DE ACEITE PARA GRUPO VAG DSG 1/2" 24MM



- Herramienta especial diseñada para el montaje y desmontaje del filtro de aceite del engranaje DSG.
- Su tamaño reducido permite alcanzar fácilmente el filtro de aceite del engranaje DSG sin necesidad de quitar la batería.



52269

7,00€

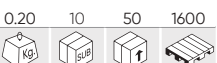

EXTRACTOR DE FILTROS DE CINTA



CINTA DE RECAMBIO

REF.	mm				€
11106	360mm	0.02	10	50	3,00€

52677

17,00€



EXTRACTOR DE FILTROS AJUSTABLE Ø65-105MM

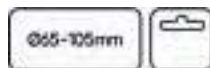

CINTA DE RECAMBIO

REF.	mm				€
11936	383mm	0.15	5	300	4,00€

52678

18,00€

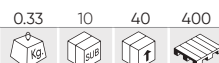

EXTRACTOR DE FILTROS AJUSTABLE Ø110-155MM

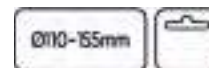

CINTA DE RECAMBIO

REF.	mm				€
11937	540mm	0.04	10	100	5,00€

EXTRACTOR DE FILTROS

52417 28,00€

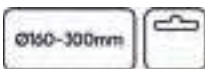
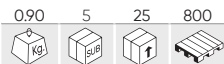

CADENA DE ALTA RESISTENCIA

52416 14,00€



CORREA DE POLÍMERO
(ALTA RESISTENCIA)

52607 49,00€

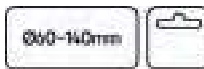
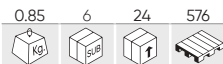

DOBLE CADENA ARTICULADA

52608 44,00€

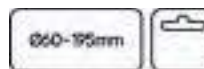
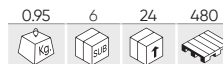

DOBLE CADENA ARTICULADA

53735



JUEGO DE VASOS PARA TAPONES DE CÁRTER 23 PIEZAS

CONTIENE

	x2	5/16", 3/8"
	x7	7, 8, 10, 11, 12, 13, 14mm
	x1	10mm
	x1	10mm
	x7	8, 9, 10, 12, 13, 14, 17mm
	x1	T45
	x1	M16

	x1	200mm
	x2	75, 150mm

44,00€

23 PCS 3/8"

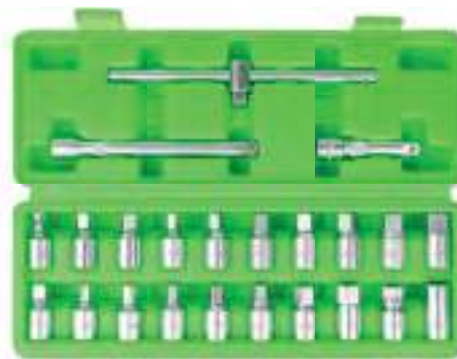

15084



MÓDULO DE EXTRACCIÓN PARA TAPONES DE CÁRTER

CONTIENE

	x2	5/16", 3/8"
	x7	7, 8, 10, 11, 12, 13, 14mm
	x1	10mm
	x1	10mm
	x7	8, 9, 10, 12, 13, 14, 17mm
	x1	T45
	x1	M16
	x1	200mm
	x1	150mm



TAMBIÉN APTO PARA RECOGEDORES DE ACEITE REF. 53873 Y 53874.

68,00€



SET REPARADOR DE ROSCAS DE TAPÓN DE CÁRTER

53235 10,40€



M13



53236 11,50€



M15



53237 12,90€



M17



53238 18,40€



M20



TAPONES DE CÁRTER PLÁSTICOS

5
PCS

REF.	DESCRIPCIÓN					€
13969	VAG	0.02	10	100	-	19,00€
53537	BMW	0.05	10	100	4000	14,50€
53538	Ford	0.10	10	100	4000	14,50€
53741	Ford / PSA	0.05	10	100	4000	14,00€



53472 12,00€

0.10	10	100	1200

LLAVE PARA TAPÓN DE CÁRTER DE PLÁSTICO (VAG)

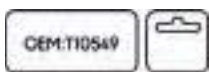

52617 7,00€

0.23	6	36	1620

LLAVE PARA TAPÓN DE CÁRTER

- Para Citroën, Renault, Peugeot.



53473 36,00€

0.40	10	50	800

SET EXTRACTOR DE TAPONES DE CÁRTER DE PLÁSTICO (5PCS)



5
PCS

A	x1	3/8"	80x100mm	Ford	OEM 1830727
B	x1	1/4"	1,5mm	VAG	OEM 06L 103 801
C	x1	1/4"	10mm	BMW	OEM 11137605018
D	x1	3/8"	3mm	Peugeot/Citroën	OEM 9801444780/OEM18711598
E	x1	1/4"	- 3/8"		

52754 54,00€

1.25	-	5	160

MEDIDOR DE PRESIÓN DE ACEITE



x1	M10x1.0mm
x1	M12x1.5mm
x1	M14x1.5mm
x1	M16x1.5mm
x1	M18x1.5mm
x1	1/8" DIN 2999
x1	1/8" x 27 NPT
x1	1/4" x 18 NPT
x1	3/8" x 20 UNF
x1	1/2" x 20 UNF

51337 50,00€

1.55	-	10	180

KIT DE REPARACIÓN PARA TAPONES DE CÁRTER

24
PCS

- Tapones de SKS3.
- Brocas de 1015.
- Arandelas de cobre.

CONTIENE

- M13x1,5P
- M15x1,5P
- M17x1,5P
- M20x1,5P
- Brocas: 1 x medida
- Tapones: 5 x medida
- Arandela: 10 x medida

DESPIECE DISPONIBLE

	REF.	DESCRIPCIÓN				€
	A 51400	M15 x 1.5P	0.15	50	100	17,00€
	B 51401	M17 x 1.5P	0.14	50	100	22,00€
	C 51402	M20 x 1.5P	0.10	25	50	20,50€
	D 51403	M13 x 1.5P	0.15	50	100	17,50€
	E 14930	M13 x 1.5P	0.05	10	100	9,50€
	F 14931	M15 x 1.5P	0.05	50	100	8,00€
	G 14932	M17 x 1.5P	0.07	5	100	9,50€
	H 14933	M20 x 1.5P	0.10	5	100	9,50€

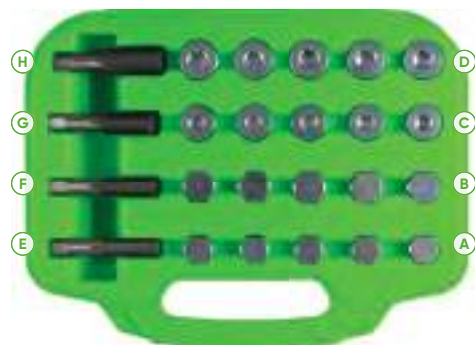

53485

140,00€



SET DE LLENADO DE ACEITE CON EMBUDO Y ADAPTADORES



- A Adaptador de rosca M42 x 4,5 para Subaru
- B Adaptador de rosca M37 x 3,0 (tipo corto) para Lotus, Pontiac, Scion, Toyota
- C Adaptador de rosca M35 x 4,0 para Ford, Jaguar, Land Rover Mazda
- D Adaptador de rosca M32 x 3,5 para Acura, Dodge, Ford, Honda, Jaguar, Jeep, Land Rover, Mazda, Nissan
- E Adaptador de bayoneta para Toyota y Lexus 3.0 y 3.3i V6
- F Adaptador de bayoneta para Audi, BMW, Mercedes-Benz, Porsche, Volvo, VW
- G Adaptador de rosca M30 x 3,0 para Dodge Cummins
- H Adaptador de rosca (1/2 vuelta) para Mazda 3 / 6 / CX-5
- I Adaptador de rosca (1/2 vuelta) para Cadillac, Chevy, Ford, GMC, Hyundai, Jaguar, Land Rover, Mazda, Saab, Mercury
- J Adaptador de rosca (1/4 de vuelta) para nuevos tapones de llenado a partir de 2088 en Audi, Seat, Skoda, VW con motor EA888
- K Adaptador de rosca (1/2 vuelta) para Dodge Hemi 6.4L (2011-) & >3.6L (>2014)
- L Adaptador de rosca M37 x 3,0 (tipo largo) para Toyota, Lexus, Scion, Pontiac

53347

100,00€



SET DE LLENADO DE ACEITE CON EMBUDO Y ADAPTADORES



- A Adaptador de rosca M42 x 4,5 para Subaru
- B Adaptador de bayoneta M37 x 3,0 para Lotus, Pontiac, Scion, Toyota
- C Adaptador de rosca M35 x 4,0 para Ford, Jaguar, Land Rover, Mazda
- D Adaptador de rosca M32 x 3,5 para Acura, Dodge, Ford, Honda, Jaguar, Jeep, Land Rover, Mazda, Nissan
- E Adaptador de bayoneta para Toyota & Lexus 3.0 & 3.3i V6
- F Adaptador de bayoneta para Audi, BMW, Dodge, Mercedes-Benz, Porsche, Volvo, VW

52305

106,00€



EXTRACTOR / REPARADOR DE CALENTADORES

16 PCS



- Extractor de bujías de precalentamiento de 16 piezas.
- Este set es útil para la extracción del calentador roto o atascado. Universal e ideal para motores Mercedes-Benz CDI.
- Extrae los calentadores rotos o dañados M8 y M10.
- Incluye machos de rosca 1/4" M8 y broca escalonada de alta resistencia de doble tamaño M8 y M10.

51494

107,00€



JUEGO DE EXTRACCIÓN DE INYECTORES

9 PCS



- | | | | |
|------------|------------|----------------------|----------|
| M12 x 1.75 | M8 x 1.5 | M14 x 1.5 | M8 x 1.5 |
| M14 x 1.5 | M17 x 1.5 | M14 x 1.5 | |
| M14 x 1.5 | M27 x 1.0 | HRC: Hardness 30 -35 | |
| M14 x 1.5 | M12 x 1.75 | 1.75Kg. | |
| M14 x 1.5 | M8 x 1.5 | | |

54186

250,00€

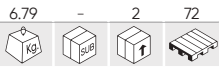

EXTRACTOR DE INYECTORES NEUMÁTICO

6-8 BAR

S

20-30 Nm

BOSCH, DELPHI, DENSO, SIEMENS

REF.	DESCRIPCIÓN	kg	sub	un	€
16366	M20X1,0 10MM	0.13	-	30	11,00€
16367	M10X1,5 14MM	0.08	-	30	10,00€
16368	M14X1,5 15MM	0.10	-	30	12,00€
16369	M14X1,5 33MM	0.12	-	30	12,00€
16370	M16X1,5 18MM	0.10	-	-	12,00€
16371	M17X1,0 10MM	0.11	-	30	11,00€
16372	M18X0,75 10MM	0.10	-	30	11,50€
16373	M18X1,5 18MM	0.10	-	30	12,00€
16374	M22X1,5 15MM	0.10	-	30	12,00€
16375	M25X0,5 9MM	0.10	-	30	15,00€
16376	M25X1,0 13MM	0.10	-	30	15,00€
16377	M26X0,75 15MM	0.10	-	30	16,00€
16378	M27X0,75 10MM	0.10	-	30	15,00€
16379	M29X1,0 11MM	0.10	-	30	15,00€
16380	M31X0,75 15MM	0.12	-	30	16,00€

REF.	DESCRIPCIÓN	kg	sub	un	€
16381	M8X1,0 14MM	0.09	-	30	10,00€
16382	M8X1,25 14MM	0.01	-	30	10,00€
16383	M14X1,5 9MM	0.13	-	30	15,00€
16384	M14X1,5 9MM	0.11	-	30	15,00€



54345

15,00€



N

SPRAY CONGELANTE

-42° 400ml
UF: MD62-11A7
0004-127H

Apto para uso en superficies metálicas enfriando el material y favoreciendo la contracción del acero para facilitar la extracción.



16295

30,00€



N

JUEGO DE 3 ADAPTADORES PARA EXTRACTOR DE INYECTORES-REF.54186



52858

298,00€

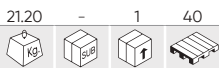

SET DE EXTRACTORES DE INYECTORES

Martillos deslizantes	1,6Kg (160mm)
	2,7Kg (460mm)
	5,1Kg (600mm)
Garras de tiro con apertura de horquilla	13,7x18mm (105mm)
	12,7x19mm (130mm)
Vasos ranurados (6 puntas)	1/2" - 25, 27, 28, 29, 30mm (100mm)
Adaptador de tiro con rosca exterior	M27x1.0
Adaptador de tiro con rosca interior	M25x1.0
	M27x1.0
Extractor de inyector, diseño del manguito, con casquillos	M17x1.0mm
	⊕ ∅ 35mm
	⊖ ∅ 29mm
Adaptador para el martillo deslizante para extractor interior, exterior y garra	



51493

68,00€



MEDIDOR Y COMPROBADOR DE SISTEMA DE INYECCIÓN

31 PCS BOSCH, SIEMENS, DENSO, DELPHI

El propósito de este instrumento es medir con rapidez y eficacia la cantidad de combustible que cada inyector vuelve al tanque de depósito, de modo que usted sabrá si algún inyector está dañado. Adecuada para uso en Bosch, Siemens, Denso y Delphi inyector.

- CONTIENE**
- Percha para colgar con 6 botellas de medición graduadas
 - Tubos de medición
 - Tubos blancos de descuento
 - Estuche de almacenaje



REF.	DESCRIPCIÓN					€
12901	BOTE + TAPÓN + MANGUERA PARA REF.51493	0.03	10	60	-	5,20€

54391

221,00€



COMPROBADOR DE INYECTORES DIESEL

0-60 MPA 5-8 BAR 0-600 BAR 0-8700 PSI M12 M14

Esta herramienta le permite comprobar el estado de los inyectores al someterlos a presión.

Está especialmente indicada para comprobar el patrón de atomización y la presión de apertura de los inyectores.

- x1 M12
- x2 M14



54392

1.855,00€

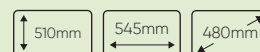

LIMPIADOR Y COMPROBADOR DE INYECTORES GDI / EFI

220V 60W 50-60 Hz
0,1-10 BAR 5-8 BAR
-85% -10°C 40°C

Este producto le permite limpiar y comprobar el correcto funcionamiento de inyectores GDI y EFI. Gracias a su microcontrolador, la máquina puede simular condiciones reales de funcionamiento del motor. De este modo, se puede apreciar el comportamiento de cada inyector y detectar posibles fallos en los mismos.

Para la limpieza de inyectores, utiliza la limpieza con ultrasonidos, garantizando así la completa eliminación de residuos que pueda haber en los inyectores tanto de gasolina como diésel. Para sistemas EFI incluye también el modo de limpieza en el vehículo.

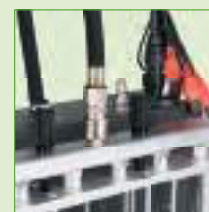

TUTORIAL DE USO

54220

197,00€



HERRAMIENTA DE EXTRACCIÓN E INSTALACIÓN DE INYECTORES DE COMBUSTIBLE PARA BMW/MERCEDES BENZ

MARCAS	<p>BMW: 135IS (2008-), 335 (2007-), 335XI (2007-), 535I (2008-), 535XI (2008-), 550I GT (2010-), 750Li (2009-), 750I (2009-), X3 3.0i (2007-), X5 (2011-), X5 3.0i (2008-), X6 (2008-)</p> <p>MERCEDES-BENZ: C-CLASS (2007-), CLK / SLK (2007-), E-CLASS (2007-), A / CLA / GLA 45 AMG (2013-), CL / CLS 63 AMG (2010-), E / G / GL 63 AMG (2011-), GLE 63 AMG (2015-) S / SL 63 AMG (2010-), SLK 55 AMG (2012-)</p>
HERRAMIENTAS OEM	<p>BMW: 130180(1), 130195(2), 130270(3), 130320(4), 2249115(5)</p> <p>MERCEDES-BENZ: 271589023300(6), 278589003300(7)</p>
CÓDIGOS DE MOTOR	<p>BMW: N14 / N18 / N20 / N47 / N54 / N57 / N55 / N63</p> <p>MERCEDES-BENZ: M133 / M152 / M157 / M270 / M271 / M274 / M276 / M278</p>

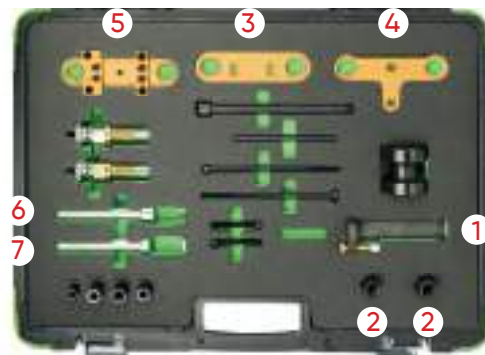

52815

110,00€



JUEGO DE EXTRACTORES DE PUNTA DE ELECTRODO DE CALENTADORES

22 PCS



53250

85,00€



JUEGO DE EXTRACTORES DE RODAMIENTOS INTERNOS Y EXTERNOS

5 PCS



53069

98,00€



EXTRACTOR DE INYECTORES DIESEL PARA CITROËN/PEUGEOT

3 PCS

CITROËN, PEUGEOT



- x1
- x3
- x2 Ø 17mm
Ø 25mm
- x2 25mm
29mm
- x1 21mm

52629

99,00€



EXTRACTOR PARA INYECTORES MERCEDES

3 PCS

MERCEDES



M16x1.5

52639

123,00€



KIT DE HERRAMIENTAS PARA EXTRACCIÓN DE BRAZOS DE DIRECCIÓN



53464

153,00€



ESTUCHE DE ARANDELAS DE COBRE PARA INYECTORES 551 PCS



PARA MÁS INFORMACIÓN

PÁGINA 387

53501

24,00€

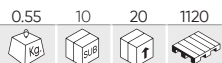

EXTRACTOR DE BOMBA DE INYECCIÓN DIESEL BMW



OEM 1 13 5 191 | 13 5 192 | 13 5 190 BMW.
BWM: M47 / M47T2 / M47TU / M57 / M57TU.
SERIES: E46 (318D-320D) (1988 - 2005) and E60, E61 (318TD-320TD-525D-530D-530-535) (2000 - 2006).

53009

42,00€

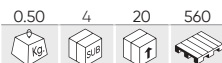

EXTRACTORES DE TUBOS DE INYECCIÓN DIESEL

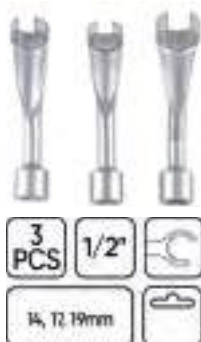

53522

24,00€



EXTRACTOR DE ARANDELAS DE INYECTORES



53696

22,00€



EXTRACTOR DE ABRAZADERAS HENN



VOLKSWAGEN, AUDI, SEAT, ŠKODA, BMW, PEUGEOT, CITROËN, DACIA, FIAT, FORD, KIA, LEXUS, MAZDA, MERCEDES, NISSAN, OPEL/VAUXHALL, PORSCHE, RENAULT, TOYOTA, VOLVO.

52757

16,00€

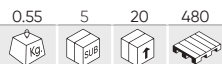

EXTRACTOR UNIVERSAL DE AFORADORES



53490

275,00€

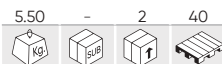

MEDIDOR DE COMPRESIÓN DIESEL Y GASOLINA

	M24
	M20
	M24
	M20
	Ø 10, 12, 14, 18mm



53096

28,80€

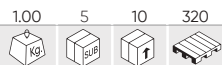

LLAVE PARA TAPA DE AFORADORES



ALFA ROMEO, BMW, CHRYSLER, CITROËN, DAEWOO, FIAT, FORD, HONDA, HYUNDAI, ISUZU, JEEP, KIA, LADA, LANCIA, LAND ROVER, LDV, MAZDA, MERCEDES, MG, MITSUBISHI, NISSAN, PEUGEOT, RENAULT, ROVER, SAAB, SSANGYONG, SUZUKI, TOYOTA, VAG, VAUXHALL/OPEL, VOLVO

54373

395,00€



MEDIDOR COMMON RAIL ALTA PRESIÓN



x2	M12x1,25	x6	M12x1,50
x2	M14x1,25	x6	M14x1,50

Es una herramienta esencial para la medición de la alta presión que se genera por la carrera de compresión en el cilindro de aire de un motor Diesel. Cuenta con una variedad de adaptadores para diferentes especificaciones y conexiones que pueden medir los distintos tipos de motores Diesel.



N

54312

191,50€



MEDIDOR DE COMPRESIÓN DIESEL



BUJÍAS
10, 12, 14, 18mm
ADAPTADORES
M20, M22, M24

ALFA, BMW, FIAT, FORD, LDV, PSA, RENAULT, SUZUKI, SAAB, CHRYSLER, DAEWOO, HYUNDAI, MERCEDES, MITSUBISHI, NISSAN, LANDROVER, MAZDA, ISUZU, OPEL.



N

52599

230,00€



COMPRESÍMETRO PARA CIRCUITOS DE COMBUSTIBLE (DIESEL Y GASOLINA)



52489

58,00€



MEDIDOR DE COMPRESIÓN - DIESEL

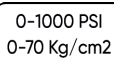

M18x1.5mm
M24x1.5mm
M24x2.0mm
M10x1.0x68mm
M10x1.25x45mm
M10x1.25x54mm
M10x1.25x68mm

FORD, BMW, MERCEDES BENZ, VW, CITROËN, MITSUBISHI, TOYOTA, PEUGEOT, RENAULT, VOLVO, MAZDA.



52685

88,00€



MEDIDOR DE COMPRESIÓN DIESEL PARA CAMIÓN

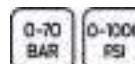

M18
M24



53997

48,00€



COMPRESÍMETRO PARA CIRCUITOS DE GASOLINA



LONGITUD	25,5cm (1), 29,5cm (2), 110cm (3)
DIÁMETRO EXTERIOR	1,2cm (1), 1,2cm (2)
DIÁMETRO INTERIOR	0,6cm (1), 0,6cm (2)



54016

76,00€



BOMBA DE COMPROBACIÓN, PRESIÓN Y VACÍO PARA CIRCUITOS

PRESIÓN MÁXIMA	40 PSI (3 BAR)
PRESIÓN MÍNIMA	-20 PSI (-0,75 BAR)



52488

28,00€



MEDIDOR DE COMPRESIÓN - GASOLINA

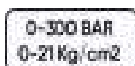

53489

68,00€



COMPROBADOR DE PRESIÓN DEL TURBO



52076

111,00€



SET REPARADOR DE ROSCAS DE CALENTADORES

- 1 Herramienta de inserción - 2uds.
- 2 Mango para pieza 8 - 1ud.
- 3 Rosca M8 x 1.0 - 5uds.
- 4 Rosca M10 x 1.0 - 5uds.
- 5 Rosca M10 x 1.25 - 5uds.
- 6 Rosca M12 x 1.25 - 5uds.
- 7 Cabezales de inserción - 3uds.
- 8 Varilla de inserción de rosca - 1ud.
- A Inserción de corte M14 x 1.25 (para roscas de M12 x 1.25) - 1ud.
- B Inserción de corte M12 x 1.25 - 1ud.
- C Inserción de corte M12 x 1.0 (para roscas de M10 x 1.25) - 1ud.
- D Inserción de corte M10 x 1.25 - 1ud.
- E Inserción de corte M10 x 1.0 (para roscas de M8 x 1.0) - 1ud.
- F Inserción de corte M8 x 1.0 - 1ud.

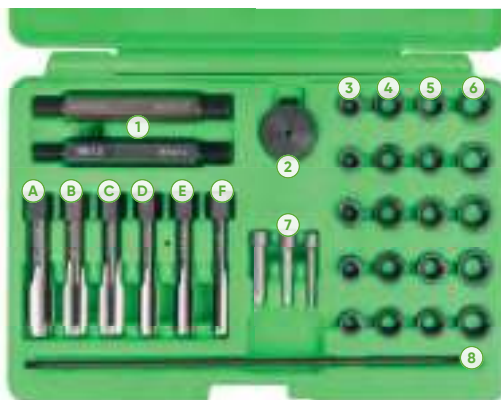

REF.	Icon	€
11893	M8x1.0 0.01 5	7,00€
11894	M10x1.0 0.01 5	7,00€
11895	M10x1.25 0.02 5	8,65€
11896	M12x1.25 0.02 5	8,80€

UTILLAJE

52813

79,00€

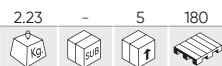

SET ESCARIADOR INYECTORES 17 PCS

17 PCS



	x8	14x14, 15x19, 15.5x15.5, 17x17x, 17x17.5, 17x19, 17x19.5, 17x20mm
	x4	15.5x15.5, 17x17, 17.5x20.5, 17x21mm
	x1	19x21.5mm

	x1	19x225mm
	x1	19x170mm
	x1	19mm
	x1	2.5mm

52273

44,00€



SET ESCARIADOR INYECTORES 8 PCS

8 PCS

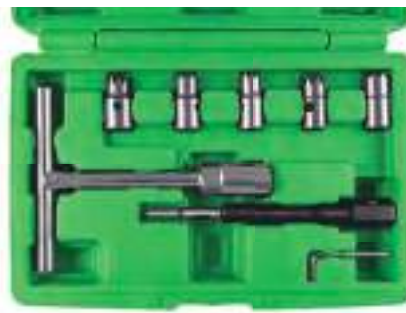

	x3	15x19mm 17x17mm BMW, PSA, Renault, Ford 17x19mm Mercedes CRD
	x2	17x17mm Mercedes 17x21mm Fiat/Iveco

	x1	12mm
	x1	19mm
	x1	

53650

47,00€



KIT DE LIMPIEZA DE ASIENTOS DE INYECTORES

19 PCS



REF.	DESCRIPCIÓN					€
14348	SET DE 3 CEPILLOS DE LATON PARA REF.53650	0.05	-	50	-	12,50€
14349	SET DE 2 CEPILLOS DE SILICONA PARA REF.53650	0.07	-	100	-	20,50€

53330

38,00€



SET DE VASOS PARA BOMBA INYECTORA

5 PCS 1/2" 1/4" Cr-V



52801

26,00€

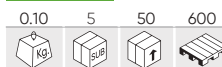

CEBADOR PARA INYECCIÓN DIESEL



52821

28,80€



LLAVE ABIERTA DOBLE PARA INYECTORES



17mm

CONJUNTO DE MATRICES

Permiten marcar numérica o alfabéticamente todo tipo de superficies metálicas mediante prensado o golpeo. El acabado redondeado de su extremo evita la aparición de grietas o roturas en la superficie trabajada.

<p>52422 24,70€</p> <p>0.82 3 6 540</p>  <p>A-Z & 0-9</p> <p>36 PCS 3/16"</p> <p>5mm</p> 	<p>53119 52,00€</p> <p>1.94 3 6 504</p>  <p>A-Z & 0-9</p> <p>36 PCS 5/16"</p> <p>8mm</p> 	<p>52882 14,00€</p> <p>0.30 10 60 1500</p>  <p>9 PCS 1/4"</p> <p>6mm 0-8</p> 
--	--	--

51120 41,00€

2.10 - 5 120



KIT COMPRESOR DE MUELLES PARA VÁLVULAS

- Válido para coches y motocicletas.
- Los 5 adaptadores permiten encajar correcto y fácilmente para comprimir el muelle de la válvula.

CONTIENE

- Compresor de Muelles.
- Adaptadores de: 30, 25, 23, 19, 16mm.



52734 51,00€

2.61 - 5 175



COMPRESOR DE MUELLES DE VÁLVULAS 45-145MM



Ø 30mm Ø 25mm
45-145mm

52693 24,50€

0.65 5 20 450



COMPRESOR DE MUELLES PARA VÁLVULAS



53251 88,00€

2.80 - 4 60



KIT DE HERRAMIENTAS PARA AROS DE PISTÓN

H:3" Ø 53-125mm
H:4" Ø 60-175mm
H:6" Ø 60-175mm



52697 16,00€

0.50 5 40 720



COMPRESOR PARA AROS DE PISTÓN 6"

6" Ø 60-175mm

150mm



52696 12,00€

0.28 5 40 1200



COMPRESOR PARA AROS DE PISTÓN 3"

3" Ø 53-175mm

77mm



UTILLAJE

ALICATES PARA SEGMENTOS DE PISTÓN

REF.	DESCRIPCIÓN					€
54273	40-100mm	0.30	6	30	-	10,10€
54274	80-120mm	0.35	6	30	-	11,00€
54275	100-160mm	0.40	6	30	-	13,20€



52591 12,00€

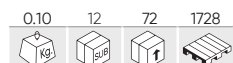

BRUÑIDOR DE CILINDROS DE DOS BRAZOS 1 - 1/8"

1-18"
28,60mm
MAX: Ø 55mm
MIN: Ø 19mm



52592 22,00€

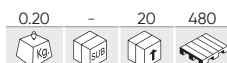

BRUÑIDOR DE CILINDROS DE TRES BRAZOS 2"

2"
50,80mm
MAX: Ø 85mm
MIN: Ø 35mm



52593 34,00€



BRUÑIDOR DE CILINDROS DE TRES BRAZOS 4"

4"
101,60mm
MAX: Ø 170mm
MIN: Ø 55mm



REF.	DESCRIPCIÓN					€
11878	JUEGO DE 2 PASTILLAS DE PULIDO 1-1/8" PARA REF.52591	0.10	25	100	-	4,10€
11879	JUEGO DE 3 PASTILLAS DE PULIDO 2" PARA REF.52592	0.04	25	100	-	5,10€
11880	JUEGO DE 3 PASTILLAS DE PULIDO 4" PARA REF.52593	0.09	25	100	-	10,50€

53662 89,00€



COMPROBADOR DE FUGAS PARA JUNTAS DE CULATA



CONTIENE
Botella redonda 200ml.
Botella cuadrada 250ml.

ADAPTADORES
Pequeño: Toyota, Mitsubishi.
Mediano: Suzuki, Toyota, Mitsubishi, Subaru, Peugeot, Nissan, Lexus, Mazda.
Grande: Ford, GM, Benz, JEEP.

REF.	DESCRIPCIÓN					€
14563	LÍQUIDO DE COMPROBACIÓN DE FUGAS EN LA COMBUSTIÓN	0.23	5	50	-	18,00€

54347 46,00€



COMPROBADOR DE FUGAS DE CILINDROS

7 BAR **100 PSI**



Diseñado para comprobar si hay fugas de los cilindros. Dispone de un manómetro en el que comprobar el nivel de fugas.

M12x1.25
M14x1.2

52832

75,00€

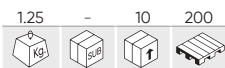

JUEGO DE LLAVES CURVADAS PARA EXTRACCIÓN DE CORREA CON CABEZAL INTERCAMBIABLE



CABEZAL INTERCAMBIABLE

x8		12, 13, 14, 15, 16, 17, 18, 19mm	x1	
x1				

52690

54,00€

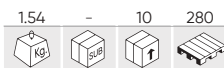

PALANCA PARA AFLOJAR POLEAS

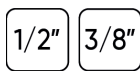

x4		3/8" - 13, 15, 16, 18mm	x1		1/2" - 230mm
x3		3/8" - 13, 14, 15mm	x1		3/8" - 585mm

53669

45,00€

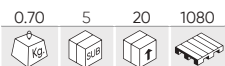

SET DE 10 VASOS DE 1/2" ESPECIALES PARA AUTOMOCIÓN



	10S	para engranaje intermedio Toyota
	6S	para embrague, culata y eje de equilibrado de Nissan y Renault
	8S	para embrague, culata y eje de equilibrado de Nissan y Renault
	12S	para embrague, culata y eje de equilibrado de Nissan y Renault
	8TS	para el eje de equilibrado de Nissan
	14mm	para pinza de freno Opel Astra G, Opel Zafira y Smart
	10mm	para sistemas de freno y bomba de combustible Nissan
	12,5mm	para sistemas de freno y bomba de combustible Nissan
	19mm	para pinza de freno de Peugeot, Renault y Citroën
	20mm	para el brazo de control inferior de Honda Civic

53053

12,00€

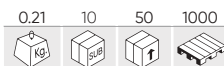

GANCHOS PARA EXTRACCIÓN DE JUNTAS

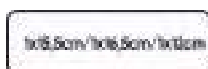

53637

85,00€

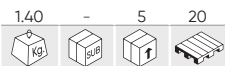

ORGANIZADOR DE PIEZAS DE CULATA

- Especial para piezas de culata.
- Mantiene todos los componentes limpios y ordenados a medida que se extraen de la culata.
- Ahorra tiempo. Te facilita el trabajo.



52850

7,80€

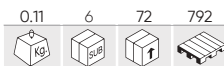

SET DE 2 LAPEADORES DE VÁLVULAS



UTILLAJE

51989

49,00€

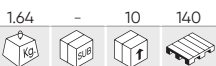

ESTUCHE 38 CEPILLOS METÁLICOS / PLÁSTICOS

38 PCS

Ø 8, 9, 10, 11, 12, 13, 14, 15, 16, 17, 18, 19mm



- 1 Mango de 1/4".
- 1 Alargador.
- 36 Cepillos.

52760

4,10€



CEPILLO METÁLICO



52515

9,10€



SET DE 3 CEPILLOS METÁLICOS

- 1 x Latón.
- 1 x Nylon.
- 1 x Acero.



52819

22,00€

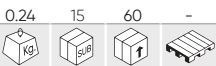

VASO DE 1/2" PARA LA TUERCA DE RETENCIÓN DE LA ANTECÁMARA DE COMBUSTIÓN (MERCEDES)

58 DIENTES



53129

84,00€

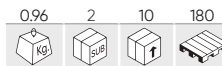

INSTALADOR AJUSTABLE DE RETENES 18-90MM



53875

134,00€

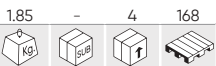

EXTRACTOR/INSTALADOR DE RETENES DE CIGÜEÑAL (GRUPO VAG)

MARCAS	VW: GOLF, TOURAN AUDI: A3, A4
HERRAMIENTAS OEM	T10134
CÓDIGOS DE MOTOR	1.4I TURBO 1.4, 1.6 INYECCIÓN DIRECTA DE GASOLINA 1.9, 2.0 SDI 2.0 DIESEL COMMON RAIL



52190

8,00€

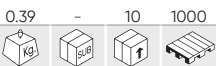

ÚTIL DE EMBRAGUE ESPECIAL FIAT

220x110mm



52495

14,50€



CENTRADOR DE EMBRAGUES DE PLÁSTICO UNIVERSAL

- Para la mayoría de los modelos del mercado.
- Incluye 3 adaptadores de diferentes diámetros.



53001

242,00€

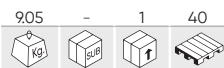

KIT CENTRADOR DE EMBRAGUE SAC

VW, AUDI, BMV, MERCEDES, VOLVO, RENAULT, OPEL

- Se evitan deformaciones del embrague.
- Utilizando la Herramienta de Reseteado llevaremos a la nueva posición el anillo de reajuste de la placa de presión al montar un nuevo disco de embrague.
- Adecuado para casi todos los embragues SAC (Embrague de Ajuste Automático).

- VENTAJAS**
- Tensado de la placa presión del embrague en el montaje y desmontaje.
 - Reposición muelle de ajuste con la herramienta de reseteado.

- CONTIENE**
- Pretensor de Embrague.
 - Centrador de 3 agujeros.
 - Herramienta de reseteado.
 - Juego de espigas centradoras.
 - Centrador de 4 agujeros.



53410

92,00€

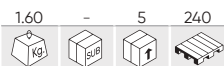

CENTRADOR DE EMBRAGUES SAC

DIÁMETRO CENTRADORES

x3 15-19, 20-26,6, 23-36mm

DIÁMETRO ACCESORIOS

x8 12, 14, 15, 16, 17, 18, 19, 20mm



53057

149,00€



JUEGO PARA LA REPARACIÓN DEL EMBRAGUE DE DOBLE CARA PARA LA TRANSMISIÓN DSG DE VAG

- Para servicio en cambios DSG en Golf (2004-), Golf Plus (2005-), AUDI A3 (2004-) con transmisiones de 7 velocidades código OAM, y en Touareg (2003-) con transmisión de 6 velocidades código 08D).
- Referencias OEM de los útiles: T10323, T10373, T10374.



50731

68,00€

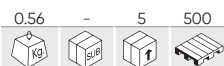

REFRACTÓMETRO PARA ALCOHOL



52963

49,00€



REFRACTÓMETRO UNIVERSAL

- Etileno glicol: -50°C ~ -0°C.
- Propileno glicol: -50°C ~ -0°C.
- Líquido limpiaparabrisas: -40°C ~ -0°C.
- UREA AUS32: - 30% ~ 35%.
- Líquido de batería: - 1.100 - 1.400 sg/l.



UREA AUS32

53477

36,10€



JUEGO DE 8 PINZAS PARA LA DESCONEXIÓN DE MANGUERAS

8 PCS
NYLON

- 8mm
- 10mm
- 13mm



53426

39,80€



PROBADOR DE PRESIÓN Y VACÍO

- PRESIÓN**
PRESSURE 0-0,7Kg/cm² (0-10 PSIG)
- VACÍO**
VACUUM 0-28 inHg (0-70 cmHg)



UTILLAJE

52066

12,00€

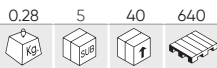

JUEGO DE TRES PINZAS PARA MANGUERAS FLEXIBLES



0-20mm
0-35mm
0-70mm

53395

16,00€

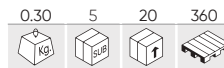

JUEGO DE TRES PINZAS PARA MANGUERAS FLEXIBLES



Ø13mm
Ø20mm
Ø35mm

52687

168,00€

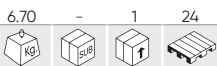

COMPROBADOR DE FUGAS DE PRESIÓN PARA SISTEMA REFRIGERACIÓN



- 1 Bomba de presión con válvula de descarga
- 2A Conector 1: acople para los cabezales No.3(R123) y No.4 (R124)
- 2B Conector 2: acople para los cabezales No. 3 (R123) y No. 5(R125).
- 3 Mercedes (W123, W126, W124, W201), GM(Buick), Jeep
- 4 Peugeot, Subaru, Chrysler, Acura, GM (Nova, Spectrum, Sprint), Mitsubishi, Nissan, Mazda, Toyota, Infiniti, GEO, Suzuki, Isuzu, Mercedes
- 5 Honda, Toyota, Suzuki, Mitsubishi, Chrysler, Acura
- 6 Mercedes Benz (ML, W163, W164), GM (Achiva, Skylark, Grand Am 1992~2002)
- 7 Volvo, Saab, Sterling, Citroën, Renault, Fiat, Alfa, Jeep
- 8 VW(Vento, T4, Passat-1996, Golf, Beetle, Sharan)
- 9 Audi(A4, A5, A6), BMW 345, VW (Passat - 1997-2002), Porsche(Cayenne)
- 10 BMW (E46, E36, E34, E39, E38, E32, E90)
- 11 Audi, VW
- 12 Internacional, Land Rover, Jaguar
- 13 Mercedes (C, E, S, W140, W220, W124, W210, W211, W215, W216, W221, R230)
- 14 Ford Focus
- 15 Mazda(M3)
- 16 Mercedes clase A (W168)
- 17 BMW E60, E63, E64, E65
- 18 VW SHARAN 1.8T 2.8
- 19 TOYOTA-RAV4, PREVIA Adaptador universal de goma para purga y llenado de radiadores.



- 20 SAAB
- 21 LAND ROVER
- 22 Kia
- 23 Hunday

54139

147,00€



COMPROBADOR UNIVERSAL DE FUGAS DE PRESIÓN PARA SISTEMA DE REFRIGERACIÓN



x1 17-24mm
x1 28-31.5mm
x1 37-39.5mm
x1 47-48.5mm



53453

7,00€



COMPROBADOR DE ANTICONGELANTE

-43°C
131°C



54368

2.329,00€

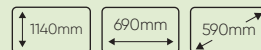
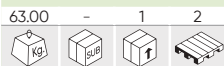

MÁQUINA DE LIMPIEZA DEL SISTEMA DE REFRIGERACIÓN

Esta máquina le permite limpiar y rellenar de líquido todo el sistema de refrigeración del vehículo de forma rápida y eficaz. A través de la generación de presión, hace circular el líquido refrigerante por todo el sistema y lo limpia de las distintas impurezas. Es compatible con los distintos tipos de refrigerantes.

La máquina se conecta a 12V a la batería del vehículo, y cuenta con una interfaz intuitiva que, junto con su pantalla táctil, dos manómetros y dos visores para observar el estado del fluido la convierten en un equipo muy fácil de utilizar. Dispone de conectores rápidos, tuberías y adaptadores para realizar la tarea cómodamente en la gran mayoría de vehículos. Contiene dos tanques de 20 litros, uno para el refrigerante nuevo y otro para el usado, ambos se vacían a través de la propia máquina. En circuitos con presencia de óxido o aceite se recomienda el uso de aditivos para un mayor poder de limpieza.

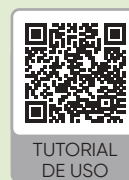
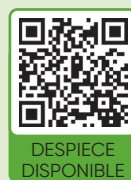

53539

66,00€



KIT DE DETECCIÓN DE FUGAS AA/CC

CONTIENE

- 1 x Lámpara UV 100Lm.
- 1 x Gafas visión UV.
- 1 x Jeringa inserción líquido.
- 1 x Adaptador rápido.
- 1 x Alargador adaptador.
- 1 x Pila recargable.
- 1 x Cargador.



REF. DESCRIPCIÓN

REF.	DESCRIPCIÓN	0.05	5	10	€
15052	PILA RECARGABLE PARA REF.53539	0.05	5	10	3,00€
15053	CARGADOR PARA REF. 53539	0.08	-	10	10,50€
15054	LINTERNA PARA REF. 53539	0.12	-	50	34,00€
14187	GAFAS VISIÓN UV PARA REF.53539	0.05	10	120	6,00€
12200	JERINGA DETECCIÓN FUGAS AA/CC PARA REF. 52844/53539	1.10	-	50	14,50€

54291

5.054,00€

116.00	-	1	1

MÁQUINA PARA CARGA DE AIRE ACONDICIONADO

200V ±10%	R134A R1234YF	3/8 HP	>2 Kg/min	100 L/min
400g/min	800g/min	12,12 cm3	LCD	50-60 Hz
99%	180W	-10° 50°		

Esta máquina ha sido diseñada para hacer trabajos de limpieza, recuperación de refrigerante, vacío, inyección de aceite y recarga de refrigerante en el sistema de aire acondicionado del vehículo. Realiza todos los procesos sin necesidad que el operario deba estar atento en todo momento.

CARACTERÍSTICAS

- COMPLETAMENTE AUTOMÁTICA
- FÁCIL DE UTILIZAR
- CON VENTANA DE INSPECCIÓN Y LUZ LED DE FONDO
- LOS MANÓMETROS FACILITAN LA OBSERVACIÓN DE LOS VALORES
- ALTA TASA DE RECUPERACIÓN DE GAS Y ACEITE
- CON PANTALLA LCD DE GRAN TAMAÑO
- CON BASE DE DATOS E IMPRESORA
- EL SOFTWARE Y LA BASE DE DATOS PUEDEN SER ACTUALIZADOS



DESPIECE DISPONIBLE



TUTORIAL DE USO

N

16309

149,00€

1.40	-	1	-

SET DE 2 TUBOS DE ALTA Y BAJA PRESIÓN DE 5 METROS PARA CAMIONES Y VEHÍCULOS INDUSTRIALES (REF.54291)



N

ADAPTADOR PARA CARGA DE GAS 1234YF

Adaptador de aire acondicionado / refrigerante de conexión rápida R1234YF. Con conexión que protege contra lesiones y pérdida de refrigerante si se desconecta bajo presión. El diseño de conexión rápida permite una completa seguridad.

Uso: AACC y refrigerante



53499

29,00€

0.20	15	60	2400

ADAPTADOR PARA CARGA DE GAS 1234YF (ALTA)

- Rojo (Alta presión)
- Material: Latón y metal
- Peso: 194g



53500

29,00€

0.20	15	60	2400

ADAPTADOR PARA CARGA DE GAS 1234YF (BAJA)

- Azul (Baja presión)
- Material: Latón y metal
- Peso: 175g



53456

98,00€

2.90	-	5	75

SET DE COMPROBACIÓN, LLENADO Y VACIADO DE SISTEMA AACC (BAR)

BAR	LOW: 0-36BAR HIGH: 0-36BAR
PSI	LOW: 0-350PSI HIGH: 0-500PSI



REF.	DESCRIPCIÓN					€
14300	ACOPLADOR PARA ALTA PRESIÓN PARA REF.53456	0.15	-	100	-	19,00€
14301	ACOPLADOR PARA BAJA PRESIÓN PARA REF.53456	0.15	-	100	-	19,00€

16316 18,50€

0.30 - 12 -

N

ACEITE UNIVERSAL PAG PARA SISTEMAS DE AIRE ACONDICIONADO 250ML

12977 36,50€

0.33 3 12 480

LÍQUIDO DE DETECCIÓN DE FUGAS PARA SISTEMA AACC 250ML

- Una aplicación de 7,5 ml para cada 1,4L de refrigerante.

50807 38,00€

0.16 6 24 744

ESTUCHE DE JUNTAS TÓRICAS PARA AACC 270 PCS

Ø	PCS	Ø	PCS
5.29x1.78	20	8.80x1.90	20
6.07x1.78	20	10.82x1.78	15
6.8x1.9	20	10.77x2.62	15
7.65x1.78	20	11.0x2.0	15
7.80x1.90	20	12.0x2.0	15
8.0x2.0	20	13.9x1.80	10

Ø	PCS
13.95x2.62	10
14.0x2.0	10
15.0x2.0	10
17.0x2.0	10
17.17x1.78	10
17.04x3.53	10

53599 30,30€

0,16 10 100 -

ESTUCHE DE OBUSES PARA AIRE ACONDICIONADO 134 PCS

DESPIECE DISPONIBLE

REF	mm	PCS	€
14594	5x19mm R12	50	2,00€
14595	5x19mm	30	1,50€
14596	5x19mm R12	30	2,00€
14597	6x19mm	3	7,60€
14598	6x26mm	1	17,80€
14599	7x20mm R134A	10	4,50€
14600	6x22mm	5	9,50€
14601	8x22mm	1	11,00€
14602	9x22mm	4	11,00€

53459 66,00€

1.05 - 10 150

KIT PARA LA DESCONEXIÓN DEL AIRE ACONDICIONADO

DIÁMETRO PINZAS

x6 8mm (5/16"), 9.5mm (3/8"), 13mm (1/2"), 16mm (5/8"), 19mm (3/4"), 22mm (7/8")

DIÁMETRO BLOQUEADOR

x4 9.5 mm (3/8"), 16mm (5/8"), 13mm (1/2"), 19mm (3/4")

54069 29,50€

0.20 10 40 360

KIT DE LIMPIEZA DE BUJES DE 14 PIEZAS

x1 Adaptador de 1/2" cuadrado de 8mm

x1 Muela con eje de transmisión redondo de 8mm

x2 Almohadillas de gancho y bucle de repuesto con la parte posterior autoadhesiva

x5 Discos de limpieza de grano grueso, con un diámetro exterior de 40 mm

x5 Discos de limpieza de grano fino de 40 mm (ø exterior) y 14 mm (ø interior)

51364 26,00€

2.00 - 5 315

EXTRACTOR DE JUNTAS HOMOCINÉTICAS

Ø 31mm 140-240mm

53638

243,00€

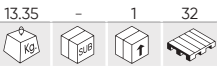

EXTRACTOR DE BUJES HIDRÁULICO

- Este kit incluye un total de tres extractores / martillos:
 - Husillo hidráulico
 - Tornillo
 - Martillo de impacto
- Todos ellos están diseñados especialmente para simplificar la extracción del cubo de la rueda y liberar el eje del buje sin dañarlo.
- Con una capacidad máxima de 10 TON.
 - Martillo de 4kg.
 - Longitud de la barra: 57cm.
 - Para 3, 4, 5, y 6 agujeros.



REF. DESCRIPCIÓN

1.35 1 10 62,00€

15253 HUSILLO HIDRÁULICO EXTRACCIÓN DE RÓTULAS PARA REF.53384/53638

54384

32,50€



LIMPIADOR DE BUJES

Permite limpiar el óxido y la corrosión que se encuentran en el buje. Dispone de superficie de velcro para acoplar el disco abrasivo fácilmente.

Diámetro externo: 150mm
Diámetro interno: 90mm
Velocidad máxima: 500RPM



REF. DESCRIPCIÓN

0.11 16 64 16,50€

16448 DISCO DE LIMPIEZA PARA BUJES (REF.54384)

52829

19,00€



HERRAMIENTA PARA MONTAJE DE FUELLES DE PALIER

EXTERIOR

Ø 10cm

INTERIOR

Ø 9,5cm



52541

45,00€



COMPROBADOR MECÁNICO DE RÓTULAS



- Para detectar juego en:
Cojinetes, silentblocks, cojinetes de rueda, articulaciones axiales, palieres, estabilizadores, etc.



51121

27,30€



KIT COMPRESOR DE MUELLES PARA AMORTIGUADORES

- Garra y Espárragos forjados con aleación Hierro - Carbono (termo - tratados).
- Indicada para usar en espacios limitados y bajo el arco de rueda.
- Apertura máxima: 270mm.



270mm

50827

387,00€

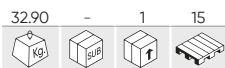

COMPRESOR DE MUELLES PARA AMORTIGUADORES



- Capacidad: 1T (2200 lbs)
- Diámetro del muelle comprimido: 200mm
- Rango de compresión: 200-500mm

53394

598,00€



COMPRESOR DE MUELLES

- Brazo telescópico y superficies antideslizantes que permite un agarre sólido de los muelles.
- Garras equipadas con una protección plástica intercambiable para evitar dañar la pintura del muelle
- Evita que se doblen los muelles en la compresión.
- Universal, cubre el 90% del parque de vehículos.
- Puede ser utilizado tanto para muelles rectos como cónicos.

CONTIENE

Dispositivo/pistón.
Tres pares de mordazas con fundas de plástico.



APTA PARA UTILIZARSE CON HERRAMIENTAS NEUMÁTICAS

IVA no incluido

53742

1.325,00€

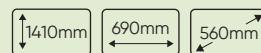

COMPRESOR PARA AMORTIGUADORES 1T

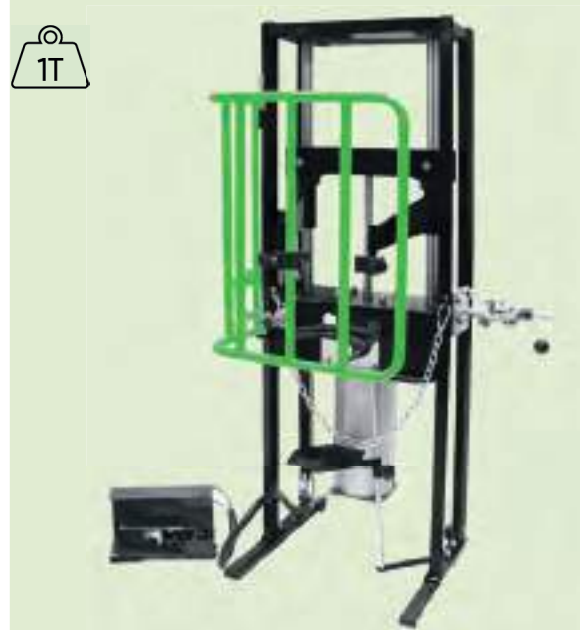

- Capacidad: 1000kg
- Longitud máxima de trabajo: 450mm
- Longitud de carrera del cilindro: 420mm
- Diámetro del muelle: Ø102-165mm
- Sentido de rotación: Horario
- Presión de aire máxima: 6.5 - 8 bar (94.27-130.53 psi / 0.65-0.9 MPa)
- Modo de funcionamiento: Pedal de pie

52227

247,00€



COMPRESOR DE MUELLE PROFESIONAL MCPHERSON

- Especificaciones:
Carga máxima: 2500N.
Un cuerpo principal.
Un soporte extendido.
3 pares de mandíbulas.
- Par 1: Rango de uso: 80-115mm, Peso: 1.45kg.
- Par 2: Rango de uso: 110-195mm, Peso: 2.2kg.
- Par 3: Rango de uso: 140-195mm, Peso: 2.3kg.

BMW, TOYOTA, FORD, MITSUBISHI, VW, AUDI, SAAB, NISSAN, HONDA ACCORD, SUBARU, VOLVO, OPEL, PORSCHE.



NO APTA PARA USAR CON PISTOLA NEUMÁTICA



www.jbmcamp.com

223

UTILLAJE

52270

109,00€



EXTRACTOR DE SILENTBLOCK PARA VAG

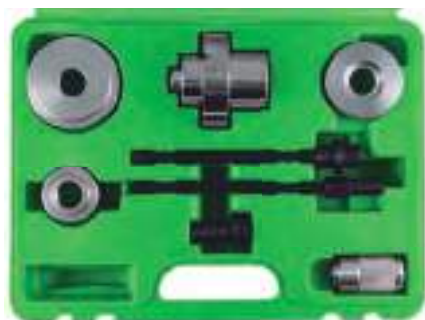

Eje, extensión de eje, tuerca de empuje M10x1,25

Cabezal adaptador de acero al carbono

Separador

Pieza de presión

Mandril de centrado de aleación de aluminio

52432

35,00€



EXTRACTOR DE SILENTBLOCK DELANTERO PARA VAG

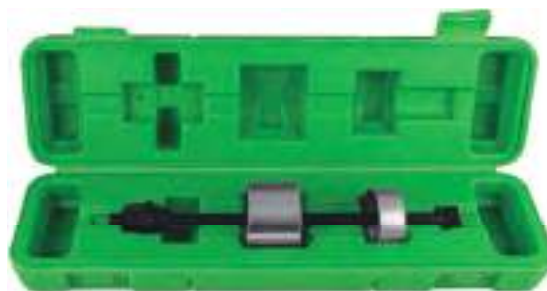

- Útil para VW POLO modelo 2002.
- Facilita el cambio de los bujes de goma del eje delantero.

EXTRACTOR

REF.	DESCRIPCIÓN	MAX	MIN					€
51368	EXTRACTOR DE RÓTULA AXIAL DE DIRECCIÓN	42mm	33mm	0.41	5	50	2700	19,00€
51369	EXTRACTOR DE TUERCAS AXIALES	42mm	35mm	0.55	6	36	756	28,00€
51414	EXTRACTOR PARA ESPÁRRAGOS	20mm	15mm	0.59	5	40	1440	14,00€



51368



51369



51414

52834

195,00€



SET DE VASOS CON ALMENAS EXTERIORES

11 PCS 1/2" Cr-Mn



x11 22x3.3mm, 26x3.8mm, 30x4.3mm, 33x4.0mm, 37x4.8mm, 44x5.3mm, 50x5.8mm, 56x5.8mm, 63x6.3mm, 69x6.8mm, 75x6.8mm

52835

272,00€



SET DE VASOS CON ALMENAS INTERIORES

10 PCS 1/2"



x10 26x5.3mm, 1,2x6.25mm, 34.2x6.3mm, 38.2x6.65mm, 42.2x7.3mm, 50.1x8.25mm, 58.2x9.8mm, 74.6x11.9mm, 82.2x13.25mm, 87.7x13mm

HERRAMIENTAS DE EXTRACCIÓN DE BRAZO DE DIRECCIÓN

REF.	DESCRIPCIÓN					€
52640	Ø 28-35mm	1.80	-	4	256	52,00€
52641	Ø 35-45mm	2.20	-	4	140	55,00€



EXTRACTOR DE BRAZOS DE DIRECCIÓN

REF.	DESCRIPCIÓN					€
52874	Ø 9-20mm	1.20	4	20	1500	82,00€
52875	Ø 14-23mm	1.25	5	20	1500	79,00€



53635

6.50	-	2	80

EXTRACTOR DE BUJES CON MAZA DESLIZANTE

- Maza deslizante: 4 kg.
- Rango diametro: 100-115mm.
- Para tornillos M12.

85,00€

440-630mm



51490

36,00€

1.88	-	5	360

SET EXTRACTOR-SEPARADOR DE RÓTULA



MANGO PARA SU USO CON UN MARTILLO
HORQUILLAS: 11/16, 15/16" Y 1-1/8"

53384

165,00€

7.30	-	2	62

EXTRACTOR DE RÓTULAS HIDRÁULICO

- Apertura: 100mm.
- Ancho: 35mm.



REF.	DESCRIPCIÓN				€
15253	HUSILLO HIDRÁULICO EXTRACCIÓN DE RÓTULAS PARA REF.53384/53638	1.35	1	10	62,00€

53208

126,00€

0.95	5	20	-

SET DE VASOS PARA TORNILLOS DE SEGURIDAD PARA BMW



APLICACIONES

BMW Serie 1 F20/F21
BMW Serie 3 F30/F31
BMW Serie 4 F32/F34/F36

BMW Serie 5 F10/F11
BMW Serie 6 F12/F13
BMW Serie 7 F01/F02/F04

x20 41, 42, 43, 44, 45, 46, 47, 48, 49, 50, 51, 52, 53, 54, 55, 56, 57, 58, 59, 60

53207

118,00€

1.55	5	10	330

SET EXTRACTOR DE TORNILLOS DE SEGURIDAD PARA VW



x1 B51 / 6PT			
x1 B52 / 7PT			
x1 B53 / 8PT			
x1 B54 / 9PT			
x1 B55 / 10PT			
x1 B56 / 11PT			
x1 B57 / 12PT			
x1 B58 / 13PT			
x1 B59 / 14PT			
x1 B60 / 15PT			
x1 B61 / 16PT			
x1 B62 / 17PT	x1 ABC3 / 14PT		
	x1 ABC4 / 15PT		
	x1 ABC5 / 16PT		
	x1 ABC6 / 17PT	x1 ABC7 / 19PT	
		x1 ABC8 / 20PT	
		x1 ABC9 / 21PT	

UTILLAJE

52802

54,00€



SET EXTRACTOR DE TORNILLOS DE SEGURIDAD PARA BMW

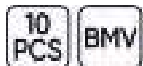

x1	30/13 PT
x1	31/15 PT
x1	32/16 PT
x1	33/17 PT
x1	34/18 PT

x1	35/19 PT
x1	36/20 PT
x1	37/21 PT
x1	38/22 PT
x1	40/23 PT

53328

76,00€



SET EXTRACTOR DE TORNILLOS DE SEGURIDAD MERCEDES

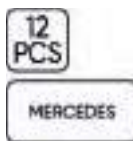

APLICACIONES

A, B, C, GLK, CLC, CLS, CLK, E, SL, SLK, M, C300, C250, C350, E320, 204, 211, 212, R

51998

38,00€

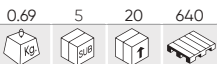

SET DE VASOS TWIST DE 3/8" PARA EXTRACCIÓN DE TUERCAS / TORNILLOS DE SEGURIDAD

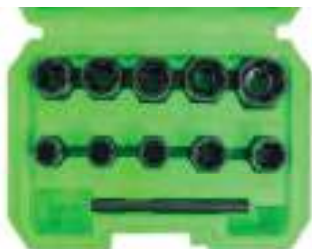
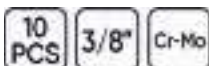

DESPIECE DISPONIBLE

REF.	mm	Kg	SUB	QTY	€
16737	9mm	0.07	-	100	12,00€
11434	10mm	0.04	-	100	12,00€
11435	11mm	0.04	-	100	12,00€
11436	12mm	0.04	-	100	12,00€
11437	13mm	0.04	-	100	12,00€

REF.	mm	Kg	SUB	QTY	€
11438	14mm	0.06	-	100	12,00€
11439	15mm	0.06	-	100	12,00€
11440	16mm	0.06	-	100	12,00€
11441	17mm	0.08	-	100	12,00€
11442	19mm	0.09	-	100	12,00€

52962

42,00€



SET DE VASOS TWIST DE 3/8" PARA EXTRACCIÓN DE TUERCAS / TORNILLOS DE SEGURIDAD 6-19MM

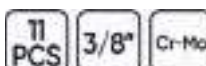

DESPIECE DISPONIBLE

REF.	mm	Kg	SUB	QTY	€
11450	6mm	0.07	-	100	12,00€
12093	8mm	0.07	-	100	12,00€
11434	10mm	0.04	-	100	12,00€
11435	11mm	0.04	-	100	12,00€
11436	12mm	0.04	-	100	12,00€
11437	13mm	0.04	-	100	12,00€

REF.	mm	Kg	SUB	QTY	€
11438	14mm	0.06	-	100	12,00€
11439	15mm	0.06	-	100	12,00€
11440	16mm	0.06	-	100	12,00€
11441	17mm	0.08	-	100	12,00€
11442	19mm	0.09	-	100	12,00€

52823

124,00€

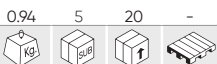

SET DE TORNILLOS DE SEGURIDAD PARA AUDI

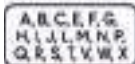
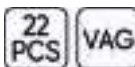

x20 A, B, C, E, F, G, H, I, J, L, M, N, P, Q, R, S, T, V, W, X

54317

124,00€

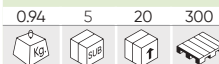

SET DE TORNILLOS DE SEGURIDAD PARA GRUPO VAG

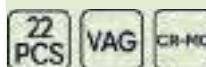

x20 521,522,523,524,525,526,527,528,529,530,531,532,533,534,535,536,537,538,539,540

52153

46,00€

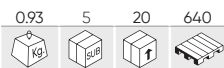

SET DE VASOS TWIST DE 1/2" PARA EXTRACCIÓN DE TUERCAS / TORNILLOS DE SEGURIDAD



DESPIECE DISPONIBLE

REF.	mm				€	REF.	mm				€
11443	17mm	0.02	25	100	14,00€	11446	23mm	0.03	25	100	15,00€
11444	19mm	0.02	25	100	14,00€	11447	27mm	0.03	25	100	15,50€
11445	21mm	0.02	25	100	15,00€						



54253

166,00€



KIT DE EXTRACCIÓN DE TORNILLOS DE SEGURIDAD DE RUEDA

Kit fácil de utilizar, capaz de desmontar cualquier tuerca de rueda con bloqueo. Incluye una cubierta que protege la rueda contra cualquier daño; tres cuchillas de doble cara para moldear en la forma del zócalo directamente; un destornillador de impacto; y un punzón. También contiene dos tamaños de cuchillas de corte de impacto para adaptarse a la mayoría de tuercas de la rueda de bloqueo mediante el corte en el borde exterior.

UNIVERSAL: Saca una amplia gama de tamaños, tipos y perfiles, incluidos los que tienen collares giratorios.

DESPIECE DISPONIBLE

REF.	DESCRIPCIÓN				€
16300	CÚTER A Y MANDRIL PARA REF. 54253	0.15	-	100	7,60€
16301	CÚTER B Y MANDRIL PARA REF.54253	0.15	-	100	7,60€
16302	CÚTER C PARA REF.54253	0.05	-	100	7,60€



54299

227,00€



JUEGO DE EXTRACCIÓN E INSTALACIÓN DE BUJES Y RODAMIENTOS

19 PCS

	5,3cm		8,6x10,9cm
	5,8cm	B	8,2x10cm
	6,5cm		7,1x9,45cm
	6,6cm		8,9x17,6cm
A	Ø 2,3mm	C	9,9x17,6cm
	7,1cm		12x17,8cm
	7,3cm	D	Ø 2,3mm 9,5cm
	7,8cm	E	Ø 8,6mm 9,55cm
	8,3cm	F	2,4x28cm

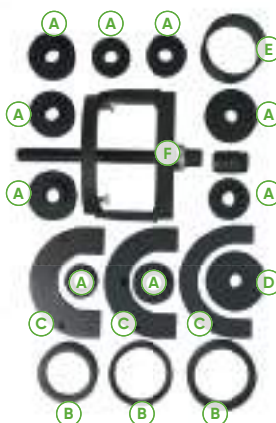

UTILLAJE

51919

89,00€

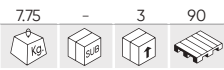

MULTIPLICADOR DE FUERZA CON ALARGADOR

4 PCS



- Material: 40CR.
- Potencia máxima: 5800Nm.
- Potencia de trabajo: 3800Nm.
- Múltiple en rango 1:56.
- Contiene vasos de: 32mm y 33mm de 1".

52796

98,00€

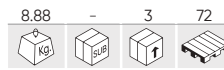

MULTIPLICADOR DE FUERZA ARTICULADO

5 PCS 6000 Nm



- Uso en camiones con tapacubos y protector de rueda.
- Evita el daño de la llanta.
- Fácil adaptación a cualquier vehículo.
- Útil para atornillar y desatornillar sin esfuerzo.

CONTIENE
1x vaso 1" 32mm.
1x vaso 1" 33mm.

51958

422,00€

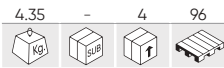

MULTIPLICADOR DE CARRACA 3/4"+ REDUCTOR DE 1/2"

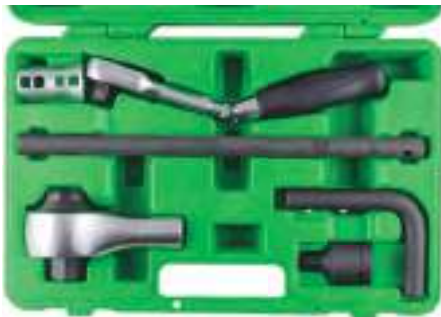

CONTIENE
1 Multiplicador de Par.
1 Carraca manual.
1 Adaptador 1/2" M x 3/4" F.
1 Kit liberación.
1 Barra de extensión 90°.
1 Barra de extensión 350mm.

CARACTERÍSTICAS
Relación de transmisión 1:4.
Relación de par 1:3.3.
Par máximo de entrada: 303Nm.
Par máximo de salida 1000Nm.

52012

68,00€



MULTIPLICADOR DE FUERZA JUNIOR

1/2"

PARA TURISMOS



CONTIENE
1 x multiplicador de par.
1 x barra de extensión 90°.
Vasos de 17mm, 19mm y 21mm.

- Rango 1:18.
- Par máx. salida: 360Nm.
- Par máx. torsión: 800Nm.

EXTRACTOR

REF.	DESCRIPCIÓN	mm	Max.	Min.					€
52642	EXTRACTOR UNIVERSAL DE BOLA	17-22mm	60mm	20mm	1.32	5	10	660	32,00€
52699	EXTRACTOR DE RÓTULAS	18-22mm	50mm	15mm	0.80	5	30	1140	22,00€



52642



52699

51123 91,00€

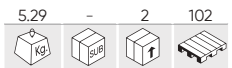

JUEGO DE 5 EXTRACTORES DE RÓTULA



- Permite la fácil extracción de los tipos más populares de articulaciones de rótula y demás.
- El tipo de separador de la prensa de la junta permite el retiro de la junta de rótula sin daño a los cargadores y a otras piezas que otro tipo de extractores pueden causar.

53488 61,00€

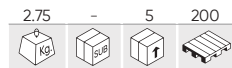

ALINEADOR DE CAÍDAS (VAG)



x1	75mm	Seat - Toledo VW - Jeta / Golf
x1	85mm	Seat - Cordoba VW - Polo / 95>
x1	115mm	Chrysler - Voyager
x1	22mm	

51902 84,00€

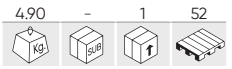

PALANCA PARA LA EXTRACCIÓN DE RÓTULAS DE BRAZO DE SUSPENSIÓN

- Medidas: 118cm de largo
- Diámetro del tubo: 3,5cm
- Distancia de anclajes: 50, 45, 40, 35, 30 cm
- Anclaje: 15x13cm



REF.	DESCRIPCIÓN	Kg	SUB	QTY	€
10953	RECAMBIO DE ANCLA DE SUJECCIÓN PARA REF.51902	0.83	-	25	12,50€

51119 62,00€

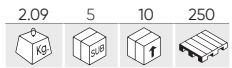

SET DE 7 PIEZAS PARA LA EXTRACCIÓN DE SONDA - LAMBDA



x1	1/2"	29x9 ~ 90mm
x1	1/2" ~ 7/8"	50mm
x1	1/2"	27x12 ~ 78mm
x1	3/8" ~ 7/8"	6 ~ 90mm
x1	3/8" ~ 7/8"	6 ~ 80mm
x1	3/8" ~ 7/8"	30mm
x1	3/8" ~ 1"	74mm
x1	1" ~ 1/16"	74mm



52637 48,00€

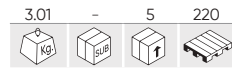

KIT DE EXPANSIÓN PARA SISTEMAS DE ESCAPE

x1	1-1/8" - 1-3/4"
x1	1-1/2" - 2-1/2"
x1	2-1/8" - 3-1/2"



51491

154,00€

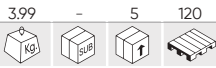

SET DE 14 PIEZAS PARA LA EXTRACCIÓN DE Sonda-LAMBDA

14 PCS

17x78mm	12PT	Renault
19x78mm	12PT	VW, Polo, Audi, Seat, Mazda
20x78mm	6PT	Deschis, Japon
27x78mm	6PT	Deschis, Japon
21x90mm	12PT	Seat, Audi, VW, Skoda, Alfa Romeo, Mitsubishi
22x78mm	12PT	Seat, Audi, VW, Skoda, Opel
22x110mm	12PT	Mercedes, Citroën, Peugeot, Ford, Nissan, Mazda, Mitsubishi, Seat, Audi, VW...



51991

54,00€

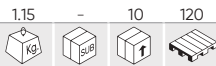

ALINEADOR DE DIRECCIÓN

- Largo total abierto: 1950mm.
- Largo total cerrado: 1100mm.
- Medida de tornillo: M6x15mm.
- Tubo exterior de 20x20 de aluminio.
- Tubo interior de 16x16 de hierro cincado.



53118

231,00€

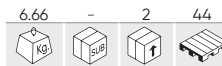

KIT PARA DESMONTAR AMORTIGUADORES



52822

32,00€

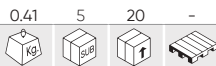

LLAVE ARTICULADA PARA LA EXTRACCIÓN DE Sonda-LAMBDA 22MM



CABEZAL ARTICULADO

52849

8,50€



SET DE 2 GANCHOS PARA EXTRAER GOMAS EN TUBO DE ESCAPE

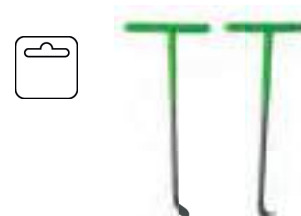

52852

6,80€

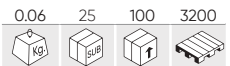

SET DE 2 GANCHOS PARA EXTRAER GOMAS EN TUBO DE ESCAPE



51347

9,90€

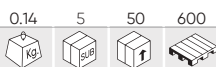

ESTETOSCOPIO

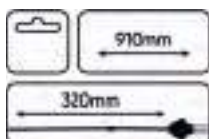

- Permite escuchar los problemas de localización racional de los flujos de agua, gas, vapor o petróleo.
- Amplifica y localiza ruidos internos, mecánicos y de paso de fluidos.
- Localiza la fuente de ruido del motor rápidamente.



53249

192,00€

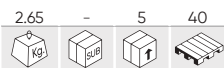

ESTETOSCOPIO ELECTRÓNICO

Kit adecuado para detección de fallos en colectores de admisión/escape, inyectores, radiadores, etc. Permite la auscultación de varios puntos del vehículo de forma simultánea, facilitando la tarea del operario a la hora de encontrar y diagnosticar averías. Sondas marcadas por color que facilitan la tarea al operario

CARACTERÍSTICAS

Longitud del cable del sensor: 4,8m
 Longitud de la sonda de audio: 14cm
 Baterías de 9V (incluida)
 Cantidad de sensores: 6
 Adecuado para conector de 3,5mm
 Longitud ajustable del micrófono: 21cm

x1	Probadores de audio	x6	Canales de micrófono de caja
x1	Cascos	x1	Velcro de sujeción para los sensores
x6	Clips de micrófono	x1	Pila cuadrada



52293

98,00€

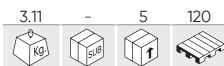

SET DE EXTRACCIÓN DE POLEAS DE ALTERNADOR DE 30 PIEZAS

A	x1	H38x3 Pins - 20mmL
B	x1	H17x4 Pins - 30mmL
C	x1	3/8" Dr. x H10
D	x1	1/2" Dr. x H10
E	x9	M10xH12 (64mmL), T50xH12 (64mmL), H10xFH10 (68mmL), H8xH10 (75mmL), M8xH10 (75mmL), M10xH10 (75mmL), H10xH10 (75mmL), T40xH10 (75mmL), T50xH19 (75mmL)
F	x3	1/2" Dr. T50 - 17mm x T33 - 100mmL, 1/2" Dr. M10 - 17mm x T33 - 100mmL, 3/8" Dr. M10 - 12mm x T31 - 85mmL,
G	x4	1/2" Dr. T50 - 140mmL, 1/2" Dr. M10 - 140mmL, 1/2" Dr. T50 - 200mmL, 1/2" Dr. M10 - 200mmL
H	x5	H17xH21 (30mmL), H15xH28 (30mmL), H19xH28 (30mmL), H21xH28 (30mmL), H22xH28 (30mmL)
I	x2	H22 (30mmL), H17 (35mmL)
J	x3	H22x22mm x T33 (300mmL), H15x15mm x T33 (30mmL), 15mm x T33 (30mmL)

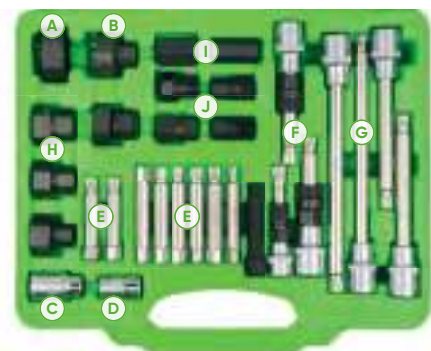

51259

58,00€



JUEGO DE EXTRACTORES PARA POLEAS DE ALTERNADOR 18 PIEZAS

DESPIECE DISPONIBLE

REF.	DESCRIPCIÓN	kg	cm	€
10485	VASO PUNTA XZN 1/2" M10 PARA REF.51259	0.10	5 100	8,10€
10486	VASO PUNTA TORX T50 CORREDIZA PARA REF.51259	0.15	5 50	8,00€
10494	VASO ALARGADOR 14CM PARA REF.51259	0.16	- -	6,50€
10495	PUNTA H10 PARA REF.51259	0.06	- -	3,00€
10496	PUNTA H8 PARA REF.51259	0.06	5 50	3,00€
10497	PUNTA M10 PARA REF.51259	0.06	5 100	3,00€
10498	PUNTA M8 PARA REF.51259	0.06	5 50	3,00€
10499	PUNTA T40 PARA REF.51259	0.05	5 60	3,00€
10500	PUNTA T50 PARA REF.51259	0.06	5 100	3,00€
10501	VASO PUNTA XZN 3/8" M10 PARA REF.51259	0.08	5 100	8,10€
10502	PUNTA M10 75MML PARA REF.51259	0.06	- 20	3,50€

CONTIENE

A	x3	T50x110mm (1/2"), M10x110 (1/2"), M10x90mm (3/8")	E	x1	1/2"x10mm
B	x1	M10x140mm	F	x1	M10x65mm
C	x2	19, 22mm	G	x6	T40, T50, M8, M10, H8, H10 (10x75mm)
D	x3	22x28, 19x28, 21x28mm	H	x1	H22

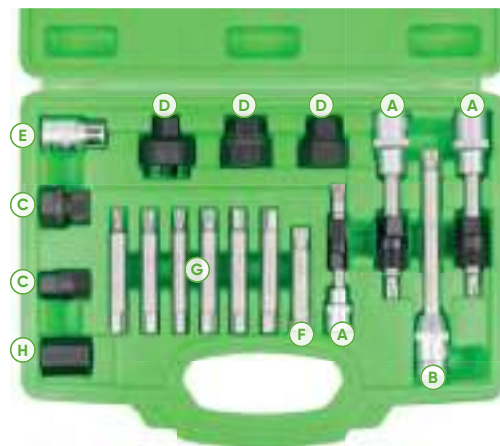

51495

59,00€

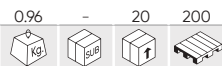

EXTRACTOR DE BOBINA DE ENCENDIDO PARA VW

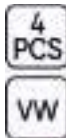

- Quitar e instalar las bobinas de encendido con tapa de motores de inyección VW CYL 8 y 12 / 5 y 6 CYL, VW GOLF, BORA, 4 y 5 CYL. VW Passat, 6 CYL, Sharan VW, Touareg, Phaeton.
- Extraer e instalar las bobinas de encendido con etapa de potencial VW Polo, Golf 1.4, 1.6i, 1.4i CADDY, BORA 1.4, 1.6i Phaeton, Passat, Touran 1.6i, Transporter T4.



EXTRACTOR DE CONEXIONES DE CALENTADOR

REF.	DESCRIPCIÓN				€
52816	EXTRACTOR DE CONEXIONES DE CALENTADOR EN ÁNGULO - 235MM	0.27	6	36	28,10€
52817	EXTRACTOR DE CONEXIONES DE CALENTADOR RECTO - 250MM	0.28	6	36	23,50€



52621

11,00€



LIMPIADOR DE BORNES DE BATERÍA



52319

8,80€



LIMPIADOR DE BORNES DE BATERÍA



LLAVE DE BUJÍA IMANTADA

REF.	"	mm					€
52316	3/8"	250mm - Ø14mm	0.20	12	48	2880	18,90€
52317	3/8"	250mm - Ø16mm	0.30	12	48	2880	19,90€



VASO DE BUJÍA HEXAGONAL

REF.	"	mm					€
10054	1/2"	16mm	0.08	10	100	-	2,90€
10055	1/2"	21mm	0.14	10	100	-	3,90€



52691

54,00€



LLAVES DE BUJÍAS ARTICULADAS

CON SISTEMA MECÁNICO DE SUJECIÓN

3/8"	8mm (82mm)	3/8"	12mm (82mm)
3/8"	9mm (82mm)	3/8"	14mm (82mm)
3/8"	10mm (82mm)	3/8"	16mm (82mm)



LLAVE ARTICULADA PARA BUJÍAS

REF.	DESCRIPCIÓN					€
54381	LLAVE ARTICULADA PARA BUJÍAS 14MM	0.35	10	40	-	5,00€
54382	LLAVE ARTICULADA PARA BUJÍAS 16MM	0.35	10	40	-	5,00€
54383	LLAVE ARTICULADA PARA BUJÍAS 21MM	0.39	10	40	-	5,00€



N

54380

119,00€

0.00	10	50	-

JUEGO DE 9 LLAVES DE VASOS CON MANGOS EN T (7-19MM)



N

DESPIECE DISPONIBLE

REF.	mm				€	REF.	mm				€
16430	7	0.17	10	50	20,50€	16565	14	0.17	10	50	19,50€
16431	8	0.17	10	50	20,50€	16566	19	0.17	10	50	22,50€
16432	10	0.17	10	50	20,50€	<div style="border: 1px solid black; padding: 5px; display: inline-block;"> 9 PCS CVT 7, 8, 10, 11, 13, 14, 15, 17, 19mm </div>					
16433	11	0.17	10	50	20,50€						
16434	13	0.17	10	50	20,50€						
16435	15	0.17	10	50	21,50€						
16436	17	0.17	10	50	21,50€						



51501

38,00€

0.88	5	20	240

SET PARA LA EXTRACCIÓN DE AIRBAGS 12 PCS

12 PCS

- Puntas 0.5 PC 1/4" x 87mm (L):
 2x Torx: T25 (para BMW), T30 (para Audi, Opel, Renault, VW).
 2x Torx (inviolable): T25H (Para BMW), T30H (Para AUDI, BMW, Mercedes, Opel).
 1x Hex: 5 mm (Para Audi).

- 0.7 PC Herramienta extracción:
 1x para Airbag conductor. 1999-04 nuevo estilo de carrocería de VW Passat, Jetta, Golf.
 2x para VW Passat B5, Polo, Lupo; Audi A4, A6, Skoda Superb.
 2x para VW Golf 4, New Beetle, Seat, Skoda Fabia, AB Oktavia BJ.99.
 1x para VW Golf 4 (BJ, 1998-2004), VW Passat BJ.1997 AB, AB Bora BJ.1999.
 1x para U.A VW-Modelle: AB Passat BJ.2000.

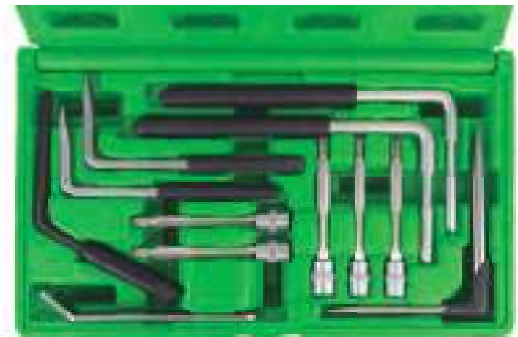

53388

90,00€

1.50	-	5	120

SET PARA LA EXTRACCIÓN DE EQUIPOS DE AUDIO 52 PCS

52 PCS

BLAUPUNKT, CLARION, SKODA, BMW, AUDI, GFUNDIG, JVC, PIONEER, VOLKSWAGEN, MERCEDES, OPEL DOPPEL-KUGEL-INBUS, PORSCHE, BECKER, KENWOOD, SONY, PANASONIC, FIAT BRAVA, FORD.



18,00€

51126

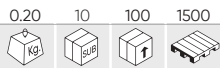

JUEGO DE ACCESORIOS PARA LA EXTRACCIÓN DE EQUIPOS DE AUDIO

10 PCS

BLAUPUNKT, PEUGEOT, CLARION, SKODA, ALPINE, BMW, OPEL, AUDI, GFUNDIG VDO, JVC, PIONEER, VOLKSWAGEN, MERCEDES, PORSCHE, RENAULT, BECKER.



53393

118,00€



SET DE EXTRACTORES DE TERMINALES 23 PCS

23 PCS



BMW, AUDI, VOLKSWAGEN, MERCEDES, OPEL, PORSCHE, JAGUAR, SAAB, SEAT, FORD, SKODA, RENAULT, CITROËN, CHRYSLER, FIAT, HONDA, MAZDA, MITSUBISHI, TOYOTA.

53391

86,00€

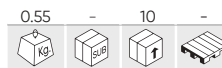

SET DE EXTRACTORES DE TERMINALES 19 PCS

19 PCS

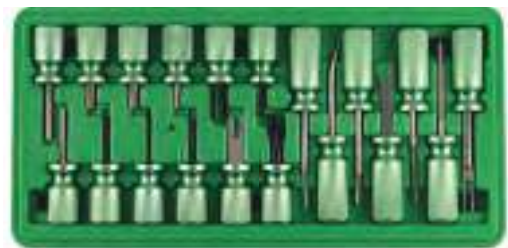

x19 A, B, C, D, E, F, G, H, I, J, K, L, A1, B2, C3, D4, E5, F6, G7

51986

11,90€



RECAMBIO DE GAS

200ml



51920

18,00€

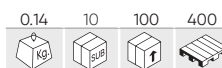

SOPLETE DE GAS



53474

94,00€

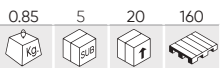

PISTOLA ESTROBOSCÓPICA DIGITAL



53240

58,00€

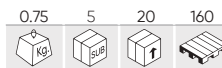

PISTOLA ESTROBOSCÓPICA



53663

8,00€

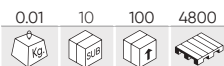

ÚTIL PARA LA EXTRACCIÓN DE CONECTORES VAG

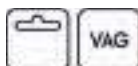

- Herramienta para desmontar conectores en vehículos del grupo VAG sin dañarlos.



KIT DE REPARACIÓN DE ROSCAS

53041

37,60€

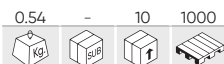

M14 x 1,25

ESPECIAL BUJÍAS



51898

139,00€

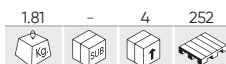

M18 x 2,5



51899

137,00€



M20 x 2,5



51896

82,00€



KIT DE REPARACIÓN DE TUERCAS HELICOIDALES 115 PCS

115 PCS



CONTIENE POR MEDIDA

Brocas.
Machos.
Insertador de Helicoil.
Puntero de rotura.
Set helicoils acero Inox.

CONTIENE

25 x M5x0.8
25 x M6x1
25 x M8x1.25
25 x M10x1.5
10 x M12x1.75

51897

122,00€



KIT DE REPARACIÓN DE TUERCAS HELICOIDALES 39 PCS

39 PCS



CONTIENE POR MEDIDA

Brocas.
Machos.
Insertador de Helicoil.
Puntero de rotura.
Set helicoils acero Inox.

CONTIENE

9 x M12x1.75
9 x M14x2
9 x M16x 2.0

RECAMBIOS HELICOIL

REF.	DESCRIPCIÓN	0.01	10	100	4800	€
52016	BOLSA DE 5 RECAMBIOS HELICOIL M5X0,8	0.01	10	300	72000	2,10€
52017	BOLSA DE 5 RECAMBIOS HELICOIL M6X1,0	0.01	500	1000	21000	2,40€
52018	BOLSA DE 5 RECAMBIOS HELICOIL M8X1,25	0.01	10	500	21000	2,60€
52019	BOLSA DE 5 RECAMBIOS HELICOIL M10X1,5	0.01	10	500	21000	3,20€
52021	BOLSA DE 5 RECAMBIOS HELICOIL M12X1.75	0.05	100	500	21000	3,40€
52022	BOLSA DE 5 RECAMBIOS HELICOIL M14X2.0	0.03	100	300	12600	4,50€
52023	BOLSA DE 5 RECAMBIOS HELICOIL M16X2,0	0.05	60	300	12600	6,60€
52024	BOLSA DE 5 RECAMBIOS HELICOIL M18X2.5	0.08	-	10	21000	10,60€
52025	BOLSA DE 5 RECAMBIOS HELICOIL M20X2.5	0.10	-	60	21000	13,00€

50793

94,00€

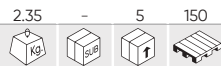

60 PCS

ESTUCHE MÉTRICO CON 60 PIEZAS DE MACHOS Y TERRAJAS COMBINADO MÉTRICO Y PULGADA



- x1 Macho NPT (pulgadas): 1/8-27
- x1 Terraja TNP (pulgadas): 1/8-27
- x1 Porta machos mixto: M3 ~ M12 y 3/16" ~ 1/2".
- x1 Porta machos mixto tipo T: M3 ~ M6 6-32 y 4-40
- x1 Porta terrajas mixto: Ø25mm
- x1 Destornillador
- x1 Juego de galgas métrico para roscar
- x1 Juego de galgas en pulgadas para roscar
- x10 Machos (métricos): M3x0.5, M4x0.7, M5x0.8, M6x1.0, M7x1.0, M8x1.25, M9x1.25, M10x1.0, M10x1.5, M12x1.75
- x10 Machos UNC (pulgadas): 4-40, 6-32, 8-32, 10-24, 12-24, 1/4-20, 5/16-18, 3/8-16, 7/16-14, 1/2-13
- x6 Terrajas UNF (pulgadas): 10-32, 1/4-28, 5/16-24, 3/8-24, 7/16-20, 1/2-20
- x10 Terrajas (métricas): M3x0.5, M4x0.7, M5x0.8, M6x1.0, M7x1.0, M8x1.25, M9x1.25, M10x1.0, M10x1.5, M12x1.75.
- x10 Terrajas UNC (pulgadas): 4-40, 6-32, 8-32, 10-24, 12-24, 1/4-20, 5/16-18, 3/8 16, 7/16-14, 1/2-13.
- x6 Terrajas UNF (pulgadas): 10-32, 1/4-28, 5/16-24, 3/8-24, 7/16-20, 1/2-20

50792

105,00€



58 PCS

ESTUCHE MÉTRICO CON 58 PIEZAS DE MACHOS Y TERRAJAS RECUBIERTAS DE TITANIO



- x1 Macho NPT: 1/8-27
- x1 Terraja TNP (pulgadas): 1/8-27
- x1 Porta machos mixto: M4 ~ M12
- x1 Porta machos mixto tipo T: M3 ~ M6
- x1 Porta terrajas mixto: Ø25mm O/D
- x1 Destornillador
- x1 Juego de galgas para roscar
- Machos: M2x0.4 (x2), M3x0.6 (x2), M3x0.5 (x2), M3.5x0.6 (x2), M4x0.75 (x2), M4x0.7 (x2), M5x0.8 (x2), M6x0.75 (x2), M6x1.0 (x2), M7x0.75 (x2), M7x1.0 (x2), M8x1.0 (x2), M8x1.25 (x2), M10x1.25 (x2), M10x1.5 (x2), M12x1.25 (x2), M12x1.75 (x2)
- x17 Terrajas: M2x0.4, M3x0.6, M3x0.5, M3.5x0.6, M4x0.75, M4x0.7, M5x0.8, M6x0.75, M6x1.0, M7x0.75, M7x1.0, M8x1.0, M8x1.25, M10x1.25, M10x1.5, M12x1.25, M12x1.75

51496

8,00€

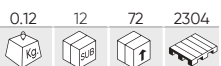

EXTRACTOR DE TORNILLOS ROTOS

- Nº1 1/8" - 1/4" (M 3-6)
- Nº2 1/4" - 5/16" (M 6-8)
- Nº3 5/16" - 7/16" (M 8-11)
- Nº4 7/16" - 9/16" (M 11-14)
- Nº5 9/16" - 3/4" (M 14-18)



53502

38,70€



SET DE EXTRACTORES DE MACHOS DE ROSCAR ROTOS

- #2 M5
- #3 M6
- #4 M8
- #5 M10
- #6 M12
- #7 M14
- #8 M16
- #9 M20
- #10 M22



53055

33,00€

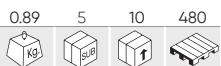

DESMONTADOR Y REMACHADOR DE CADENAS DE MOTOCICLETAS

PINES 2.2mm, 2.9mm, 3.8mm



54280



156,50€

7 PCS N

SET DE REPARACIÓN DE ROSCAS DE BUJÍAS

DESPIECE DISPONIBLE

REF.	DESCRIPCIÓN				€
16237	M8X1,0 115MM	0.10	10	40	23,00€
16238	M10X1,0 115MM	0.10	10	40	23,00€
16239	M12X1,25 140MM	0.15	10	40	23,00€
16240	M12X1,25 270MM	0.30	10	40	26,00€
16241	M14X1,25 140MM	0.15	10	40	23,00€
16242	M14X1,25 270MM	0.35	10	40	26,00€
16243	M18X1,5 90MM	0.10	10	40	23,00€

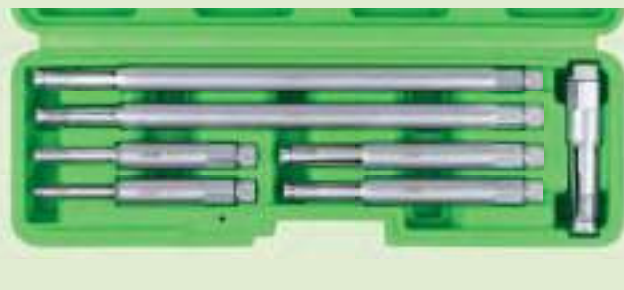

52833

39,30€

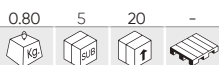

SET DE VASOS DE EXTRACTORES DE ESPÁRRAGOS DE 1/2"



DESPIECE DISPONIBLE

REF.	mm				€
14211	6mm	0.10	20	100	11,00€
14212	8mm	0.10	20	100	12,00€
14213	10mm	0.20	20	100	12,00€
14214	12mm	0.20	20	100	14,00€

53524

51,00€



ESTUCHE DE LLAVES ROMPETUERCAS



DESPIECE DISPONIBLE

REF.	mm					€
14049	9-12 mm (1/8"- 1/2")	0.10	-	50	-	8,00€
14050	12-16 mm (1/2"- 5/8")	0.20	-	50	-	10,50€
14051	16-22 mm (5/8"- 7/8")	0.44	25	50	-	18,00€
14052	22-36 mm (7/8"- 1- 1/16")	0.65	-	20	-	19,50€

53652

53,00€



SET DE REPARACIÓN DE ROSCAS PARA TORNILLOS DE RUEDA

DESPIECE DISPONIBLE

REF.	DESCRIPCIÓN				€
14340	TORNILLO REPARADOR M12X1.25 - PSA PARA REF.53652	0.05	-	20	10,50€
14341	TORNILLO REPARADOR M12X1.5 - MERCEDES BENZ / BMW PARA REF.53652	1.14	-	20	10,50€
14342	TORNILLO REPARADOR M12X1.75 - VOLVO PARA REF.53652	1.12	-	20	10,50€
14343	TORNILLO REPARADOR M14X1.5 - VAG PARA REF.53652	1.29	-	20	10,50€
14344	DISCO REPARADOR M12X1.25 PARA REF.53652	0.49	-	20	11,00€
14345	DISCO REPARADOR M12X1.5 PARA REF.53652	0.50	-	20	11,00€
14346	DISCO REPARADOR M14X1.5 PARA REF.53652	0.46	-	20	11,00€



UTILLAJE

54003

104,00€



SET REPARADOR DE ROSCAS INTERIORES Y EXTERIORES

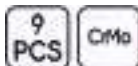

- x1 M14x1.5
- x1 M16x1.5
- x1 M18x1.5
- x1 M20x1.5
- x1 M22x1.5
- x1 M24x1.5
- x1 M27x2.0
- x1 M28x1.5



53665

19,00€

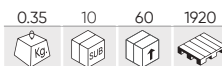

CORTADOR DE CADENAS DE MOTOCICLETA (25-60)



53666

28,00€



CORTADOR DE CADENAS DE MOTOCICLETA (60-100)



53054

6,00€



LLAVE DE VASO ESPECIAL MOTOCICLETAS



53086

9,00€



LLAVE PARA MOTOCICLETA



YAMAHA, KAWASAKI,
BMW, SUZUKI, HONDA

52454

12,90€



EXTRACTOR DE BRAZO LIMPIAPARABRISAS



53664

38,00€



EXTRACTOR DE POLEAS UNIVERSAL



Eje de 16mm de diámetro con bola centradora y cabeza de tornillo hexagonal de 24mm.

51125

88,00€



JUEGO DE EXTRACTORES DE GUILLOTINA



SET PULGADA

- x2 1/4", con 30mm y 50mm.
- x1 Tornillo de 3/8" de 95x125 - 24 UNF.
- x1 Cabeza de 3/8" x 16 UNC.

SET 2 PULGADAS

- x1 1/4" - 3 1/2", con 50x75mm.
- x1 Tornillo de 1/2" de 12.7x135 20 UNF.
- x1 Cabeza de 3/8" x 16 UNC.

EXTRACTOR DE GUILLOTINA

REF.	DESCRIPCIÓN	Kg	SUB	QTY	€
52626	75-105mm	3.65	-	5 800	46,00€
52627	105-150mm	6.50	-	2 231	120,00€



EXTRACTOR DE DOS PATAS

REF.	DESCRIPCIÓN	—	I					€
52727	EXTRACTOR DE DOS PATAS 25-70MM	25-70mm	50mm	0.20	10	60	1200	34,60€
52728	EXTRACTOR DE DOS PATAS 25-130MM	25-130mm	110mm	1.20	5	10	500	68,00€
52729	EXTRACTOR DE DOS PATAS 60-200MM	60-200mm	160mm	3.26	-	3	240	128,00€
52730	EXTRACTOR DE DOS PATAS 80-350MM	80-350mm	225mm	8.55	-	2	108	288,00€

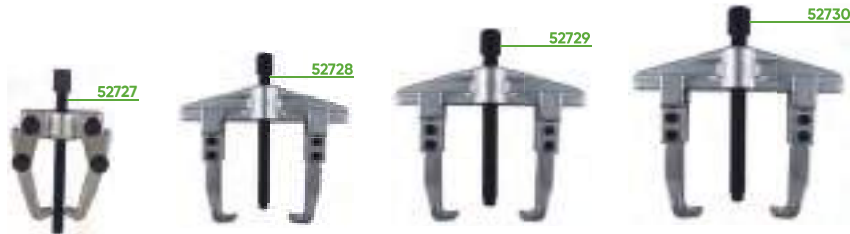

REF.	DESCRIPCIÓN					€
53146	EXPOSITOR DE EXTRACTORES DE RÓTULA	0.70	5	10	140	30,50€

EXTRACTOR DE TRES PATAS

REF.	DESCRIPCIÓN	—					€
52731	EXTRACTOR DE 3 GARRAS 50-100MM	50-100mm	0.90	4	24	504	38,00€
52732	EXTRACTOR DE 3 GARRAS 70-150MM	70-150mm	2.54	5	20	200	58,00€
52733	EXTRACTOR DE 3 GARRAS 95-200MM	95-200mm	5.20	-	4	112	98,00€



EXTRACTOR DE 3 GARRAS CONVERTIBLES Y REVERSIBLES

REF.	DESCRIPCIÓN	T					€
52010	EXTRACTOR DE 3 GARRAS CONVERTIBLES EN 2 REVERSIBLE 2T	2T	0.50	4	40	360	80,00€
52296	EXTRACTOR DE 3 GARRAS CONVERTIBLES EN 2 REVERSIBLE 5T	5T	1.57	4	8	120	119,00€
52297	EXTRACTOR DE 3 GARRAS CONVERTIBLES EN 2 REVERSIBLE 7T	7T	3.33	-	6	36	172,00€
52298	EXTRACTOR DE 3 GARRAS CONVERTIBLES EN 2 REVERSIBLE, GARRA CORTA Y LARGA	2T	2.65	3	6	396	177,00€



53701

188,00€

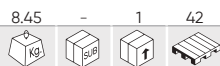

EXTRACTOR DE COJINETES CON 2/3 GARRAS INTERCAMBIABLES

- Rango extractor 2 patas: 45-120mm.
- Rango extractor 3 patas: 50-130mm.
- Profundidad de las garras: 100, 200, 250mm.

CONTIENE

- Guía central de 3 garras.
- Guía central de 2 garras.
- Espárrago de 275mm.
- Espárrago de 165mm.
- Garras de agarre largo: 250mm.
- Garras de agarre medio: 200mm.
- Garras de agarre corto: 100mm.

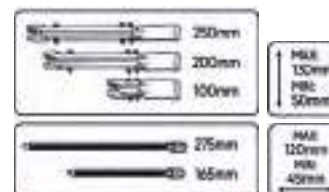

REF. DESCRIPCIÓN

REF.	DESCRIPCIÓN	Kg	Vol	Alt	€
14611	GARRA PARA EXTRACTOR DE COJINETES CON 2/3 GARRAS INTERCAMBIABLES PARA REF.53701	0.10	-	50	12,00€
14612	TORNILLO DE 165MM PARA EXTRACTOR DE COJINETES CON 2/3 GARRAS INTERCAMBIABLES PARA REF.53701	0.15	-	20	11,00€
14613	TORNILLO DE 275MM PARA EXTRACTOR DE COJINETES CON 2/3 GARRAS INTERCAMBIABLES PARA REF.53701	0.30	-	20	13,50€

53062

99,00€

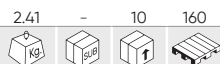

EXTRACTOR DE COJINETES CON ESFERAS FALSAS



51140

64,00€



EXTRACTOR ROSCADO PARA POLEA DE CIGÜEÑAL

- Diseñado para sostener la polea del árbol de levas inmóvil mientras que se afloja.
- Permite el ajuste del eje central cuando se acoplan, usando la barra atornillada centrada para desarraigar la polea.
- Tornillos de fijación: M6, M8.



51500

29,00€



EXTRACTOR DE POLEAS ACANALADAS

- Apto para el uso en cigüeñales, alternadores, unidades de AACC y bombas de agua.
- Los brazos del perfil bajo permiten un fácil acceso a zonas difíciles del motor.
- Diseñado para la extracción del cigüeñal acanalado, agarrotado y de poleas auxiliares.



40-168mm

52494

227,00€

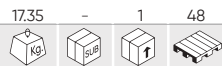

EXTRACTOR UNIVERSAL DE RETIRADA / INSTALACIÓN DE BUJES, RODAMIENTOS Y SILENTBLOCKS

- Para instalar y desinstalar casquillos y cojinetes de suspensión.
- Contiene manguitos de diferentes tamaños y barras roscadas de diferentes métricos.
- Medidas: M10, M12, M14, M16, M18.

ADAPTADORES (DIÁMETRO EXTERNO/INTERNO):

90/80, 85/75, 82/72, 80/70, 78/68, 76/66, 74/64, 72/62, 70/60, 68/58, 66/56, 64/54, 62/52, 60/50, 58/48, 56/46, 54/44, 52/42, 50/40, 48/38, 46/36, 44/34

REF.	DESCRIPCIÓN	Kg	m³	U	€
12926	ESPÁRRAGO M10 PARA REF.52494	0.46	-	20 1500	21,50€
12927	ESPÁRRAGO M12 PARA REF.52494	0.52	-	20 -	21,50€
12928	ESPÁRRAGO M14 PARA REF.52494	0.60	-	30 1500	22,00€
12929	ESPÁRRAGO M16 PARA REF.52494	0.66	-	20 -	23,00€
12930	ESPÁRRAGO M18 PARA REF.52494	0.89	-	30 -	23,50€

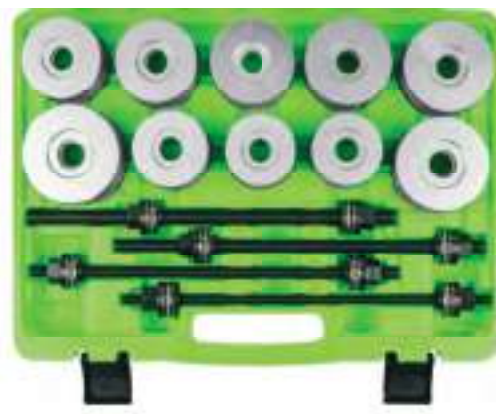

51124

88,00€



JUEGO DE EXTRACCIÓN DE COJINETES

5 PCS

UNIVERSAL



CONTIENE

- Extractor Universal (38,5mm).
- Adaptador de 3/8" a 1/2" (10-14mm).
- Adaptador de 9/16" a 11/16" (15-19mm).
- Adaptador de 5/8" a 1" (18-25mm).
- Adaptador de 1" a 1 1/4" (25-32mm).

52624

28,00€



EXTRACTOR DE POLEAS ARMÓNICO

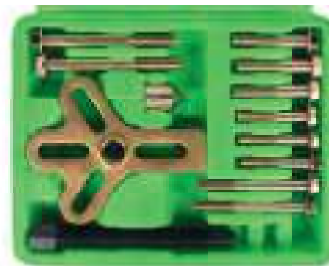

x2	Tornillo 5/16" de 4"
x2	Tornillo 1/4" de 3"
x3	Tornillo 1/4" de 2"
x3	Tornillo 5/16" de 2"
x1	5" Tornillo de presión de aleación de aluminio
x1	Punta giratoria 3/4"

53058

193,00€

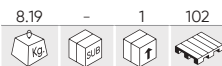

JUEGO DE PASTILLAS DE MONTAJE PARA RODAMIENTOS

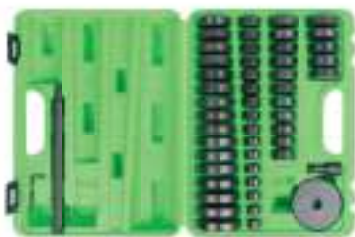

x49	Ø 18, 19, 20, 21, 22, 23, 24, 25, 26, 27, 28, 29, 30, 31, 32, 33, 34, 35, 36, 37, 38, 39, 40, 41, 42, 43, 44, 45, 46, 47, 48, 49, 50, 51, 52, 53, 54, 55, 56, 57, 58, 59, 60, 61, 62, 63, 64, 65, 74mm
x1	Mango de metal (para su uso con martillo) de diametro Ø 12mm

53056

127,00€

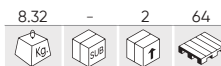

JUEGO DE EXTRACCIÓN E INSTALACIÓN DE RODAMIENTOS



x9	Ø 55.5, 59, 62, 65, 66, 71.5, 73, 78, 84mm	x1	Ø 69mm
x2	Ø 75.5, 83mm	x1	295mm

UTILLAJE

52551

151,00€

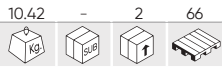

KIT DE EXTRACCIÓN E INSTALACIÓN DE RODAMIENTOS

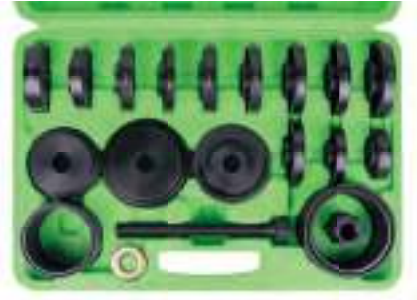

x13 Discos: 50, 55, 60, 64, 67, 70, 72, 74, 75, 78, 82, 84, 88mm

x4 Cilindros: 76, 82, 92, 101mm

x1 Perno: 32mm

x1 Tuerca: 38mm

x1 Tornillo reforzado para uso con herramienta de impacto

x1 Eje de acero-fosfato para evitar la corrosión

53463

98,00€

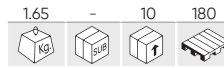

SET EXTRACTOR DE BRAZO LIMPIAPARABRISAS



VW: Polo, Lupo, Touareg, Porsche Cayenne.
Opel: Astra G, Zaphira B, Corsa C, Vectra C.
Honda: Jazz, CRV, FRV, Accord, Turnier.
BMW:
5º Modelo a partir de E 39 hasta 2005.
7º Modelo a partir de E 38 hasta 2005.
Audi: A3, A4, A5, A6, Audi Q7.
Ford: Galaxy, Alhambra.
Mercedes: A-Class, B-Class.

51349

37,30€

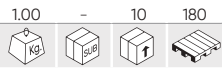

JUEGO PARA LA INSTALACIÓN DE RODAMIENTOS



x13 42 - 38mm, 40 - 35mm, 36 - 32mm, 30 - 28mm, 24 - 22mm, 27 - 25mm, 18 - 16mm, 20 - 18mm, 22 - 20mm, 12 - 10mm, 14 - 12mm, 16 - 14mm, 17 - 15mm

53059

52,00€

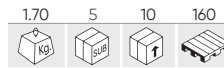

JUEGO PARA LA INSTALACIÓN DE RODAMIENTOS Y RETENES



x9 Ø 39.5, 44.5, 50, 59, 63, 65, 72, 76, 81mm

52056

66,00€



SET DE 8 VASOS DE 1" PARA MULTIPLICADOR DE FUERZA

DESPIECE DISPONIBLE

REF.	DESCRIPCIÓN	Kg	Vol	Q	€
16385	VASO MULTIPLICADOR DE FUERZA 22MM 1" PARA REF.52056	0.50	-	50	10,00€
16386	VASO MULTIPLICADOR DE FUERZA 24MM 1" PARA REF.52056	0.45	-	50	11,50€
10674	VASO MULTIPLICADOR DE FUERZA 27MM 1" PARA REF.52056	0.59	-	50	9,50€
10675	VASO MULTIPLICADOR DE FUERZA 30MM 1" PARA REF.52056	0.55	-	50	9,50€
10672	VASO MULTIPLICADOR DE FUERZA 32MM 1" PARA REF.52056	0.66	-	50	9,50€
10673	VASO MULTIPLICADOR DE FUERZA 33MM 1" PARA REF.52056	0.67	-	50	9,50€
16388	VASO MULTIPLICADOR DE FUERZA 38MM 1" PARA REF.52056	0.70	-	50	11,50€
16389	VASO MULTIPLICADOR DE FUERZA 41MM 1" PARA REF.52056	0.75	-	-	11,50€



KITS DE CALADO (TIMING TOOLS)

- 244 FIAT/ALFA ROMEO
- 249 BMW/MINI
- 258 PSA
- 261 FORD
- 267 JAGUAR/LAND ROVER
- 269 JEEP/CHRYSLER
- 270 MERCEDES-BENZ
- 273 RENAULT/DACIA/NISSAN
- 278 OPEL/VAUXHALL
- 283 VAG
- 295 OTROS
- 297 HERRAMIENTAS AUXILIARES



KITS DE CALADO (TIMING TOOLS)

53303

89,00€



KIT DE CALADO FIAT / OPEL

MARCAS	FIAT: 1.9D/JTD (MOTOR PEUGEOT), 2.4D. ALFA ROMEO: 145, 146, 156 JTD. GM: GM 1.3, 1.6, 1.9, 2.0, 2.4 CDTI (2004 -).
HERRAMIENTAS OEM	EN-46789 (1), EN-46789-100 (2), EN-46785 (3), EN-46788 (4), EN-46781 (5), EN-46789 (6)
CÓDIGOS DE MOTOR	GM: K1.3 CDTI Z13DT COMMON RAIL ENGINE. 1.9 CDTI / 04-12 - Z19DT Z19DTH Z19DTJ Z19DTL 2.0 CDTI / 08-12 - A20DT LBS / LBX / LBY / LCD.V SAAB: 1.9 TID.



53304

279,00€



KIT DE CALADO FIAT

MARCAS	FIAT
HERRAMIENTAS OEM	1 860 874 000 (1), 1 860 895 000 (2), 1 860 898 000 (3), 1 860 905 000 (4), 1 860 845 000 (5)
CÓDIGOS DE MOTOR	PETROL: FIAT BRAVA , BRAVO, BARCHETTA, CARGO, COUPE, MAREA, PALIO, WEEKEND, PUNTO, MULTILA, STILO, IDEA, DO-BLO TWIN CAM ENGINES - 1.2, 1.4, 1.6, 1.8, 16V GASOIL: FIAT BRAVA, BRAVO, MAREA, WEEKEND, PALIO, PUNTO, MULTIPLA, DOBLO, ULYSSE, DUCATO, STILO JTD DIESEL ENGINES - 1.9D/TD . 1.9JTD . 2.4TD/JTD.

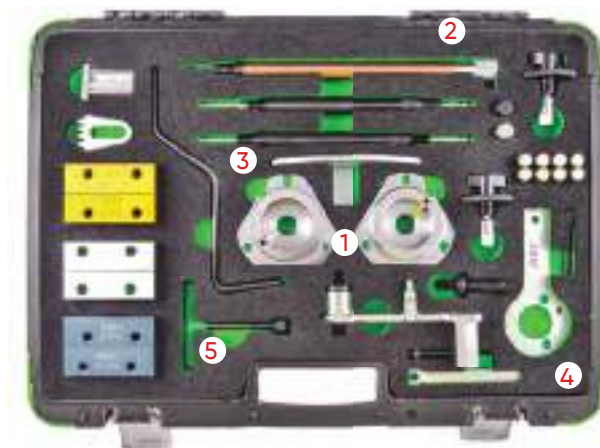

53306

53,00€



KIT DE CALADO FIAT 1.2 16V

MARCAS	FIAT: FIAT 1.2L 16V, FIAT PUNTO / BRAVA / BRAVO / STILO
HERRAMIENTAS OEM	1860992000 (1) (2), 1871000900 (3), 1860987000 (4), 186985000 (5)
CÓDIGOS DE MOTOR	176 B9.000, 182 B2.000, 188 A5.000



53308

55,00€

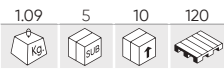

KIT DE CALADO ALFA ROMEO

MARCAS	ALFA ROMEO: 145,146,147,155,156, 1.4 1.6 1.8 2.0 TS, 1.4/1.6 16V; 145/146/147/155/156 (96-10), 1.8 16V; 145/146, (96-01), 155/156 (96-06), SPIDER/GTV (98-05), 2.0 16V; 145/146 (96-01), 147 (01-10), 155/156 (95-02), 166 (98-07), SPIDER/GTV (96-05), PÚRPURA / PURPLE: 1.4, 1.6 // AZUL / BLUE: 1.8, 2.0
HERRAMIENTAS OEM	1822149000 (1), 1822154000 (2), 1825041000 (3), 1825042000 (4)
CÓDIGOS DE MOTOR	Z1.4/1.6-321.02, 321.03, 321.04, 335.03, 676.01 1.8/2.0-323.01, 672.04, 162.01, 323.10, 671.06, 322.01, 671.02, 322.05, 341.03, 363.01.

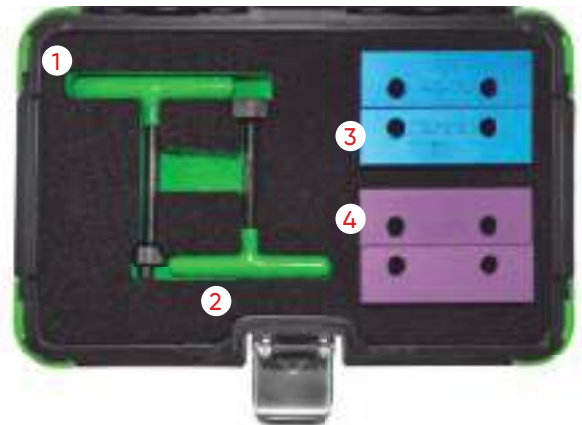

53309

285,00€

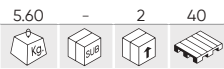

KIT DE CALADO ALFA/FIAT/LANCIA 1.4, 1.6, 1.8, 2.0 16V

MARCAS	ALFA ROMEO: 145,146,147,155,156, 1.4 1.6 1.8 2.0 TS, 1.4/1.6 16V; 145/146/147/155/156 (96-10), 1.8 16V; 145/146, (96-01), 155/156 (96-06), SPIDER/GTV (98-05), 2.0 16V; 145/146 (96-01), 147 (01-10), 155/156 (95-02), 166 (98-07), SPIDER/GTV (96-05), PURPUR: 1.4, 1.6 // BLAU: 1.8, 2.0 FIAT: BARCHETTA (96-00), BRAVA (95-00), BRAVO (95-0 0), COUPE (96-01), MAREA (96-00), MAREA WEEKEND (96-00), PUNTO/PUNTO CLASSIC (99-06), STILO (01-08) LANCIA: DEDRA (95-99), DELTA (96-99), KAPPA (98-02), LYBRA (99-06).
HERRAMIENTAS OEM	1.4 16V: 335.03 1.6 16V: 321.02, 321.03, 321.04, 372.03, 676.01 1.8 16V: 322.01, 322.05, 671.06, 182A2.000, 183A1.000, 183A6.000, 188A6.000, 192A4.000 2.0 16V: 162.01, 323.01, 323.1, 341.03, 363.01, 672.04 2.0 20V: 175A3.000, 182A1.000, 182B7.000, 185A8.000.



53310

498,00€

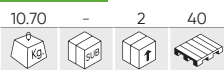

KIT DE CALADO FIAT/ALFA/LANCIA

MARCAS	ALFA FIAT LANCIA	ALLA, BARCHETTA, BRAVO, BRAVA, COUPE, DELTA, DEDRA, PUNTO, SPIDER, GT
HERRAMIENTAS OEM	1860845000 (1), 1822154000 (2), 1860905000 (3), 1860992000 (4), 1860895000 (5), 1860874000 (6), 1860985000 (7), KM571A (8), 1 860 896 000 (9), 0153A (10)	
CÓDIGOS DE MOTOR	1.2 / 16V, 1.4 / 12V, 1.6 / 16V, 1.6 ECO. 1.8, 2.0 / 16V, 2.0 / 20V, 2.4 / 20V, 3.0 / V6.	



KITS DE CALADO (TIMING TOOLS)

53312

127,00€



KIT DE CALADO FIAT/ALFA/FORD

MARCAS	FIAT: NEW 500 (07-09), IDEA (04-09), LINEA (07-09), GRANDE PUNTO (07-09), DOBLO 1 CARGO (05-09), PANDA EV02 (05) FORD: KA 1.2 DURATEC (09) ALFA ROMEO
HERRAMIENTAS OEM	1 860 987 000 (1), 2 000 004 400 (2), 2 000 015 800 (3), 2 000 004 300 (4), 2 000 004 500 (5)
CÓDIGOS DE MOTOR	1.2: 169A4.000 / 199A4.000 . 1.4: 350A 1.000 / 188A4.000-EV02.

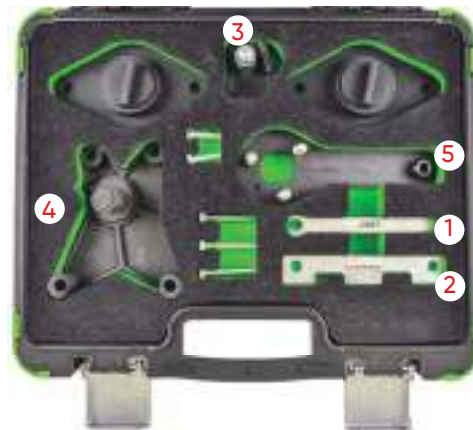

53319

18,00€

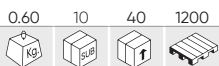

KIT DE CALADO FIAT IVECO 2.3, 3.0 JTD

MARCAS	FIAT: 2.3 / 3.0 JTD. IVECO: DAILY.
HERRAMIENTAS OEM	99360614, 1 860 617 000, 99360615, 2 000 018 200.
CÓDIGOS DE MOTOR	F1AE0481C, F1AE0481D, F1AE0481N, F1CE0481A/D.



54202

68,00€



KIT DE CALADO PARA FIAT/ALFA ROMEO/LANCIA

MARCAS	ALFA ROMEO: GIULIETTA (10-14), MITO (08-17). FIAT: 500 (07-19), 500L (12-19), 500C (07-19), 500 ABARTH (08-17), BRAVO (07-14), BRAVA/BRAVO (98-02), DOBLO/DOBLO CARGO (10-19), EGEA (15-20), GRANDE PUNTO (07-10), GRANDE PUNTO ABARTH (07-10), IDEA (04-12), LINEA (07-10), MAREA/WEEKEND (98-00), PALIO WEEKEND (01-06), PANDA (07-11), PUNTO (97-08), STILO (01-08), TIPO (15-20). LANCIA: DELTA (08-12), MUSA (04-13), YPSILON (96-11).
HERRAMIENTAS OEM	2.000.004.500 (1), 1.860.985.000 (2), 1.860.992.000 (3), 1.860.987.000 (4), 2.000.015.800 (5)
CÓDIGOS DE MOTOR	1.2 16V:176B9.000, 182B2.000, 188A5.000. 1.4 16V / T-JET: 169A3.000, 192B2.000, 198A1.000, 198A4.000, 199A6.000, 198A8.000, , 312A1.000, 312A3.000, 843A1.000, 955A1.000.



54203

91,00€

**KIT DE CALADO PARA ALFA ROMEO/LANCIA 1.8 TBI**

MARCAS	ALFA ROMEO: 159(09-12), BRERA(09-11), GIULIETTA(10-19), SPIDER(09-11), 4C(13-19). LANCIA: DELTA(09-14).
HERRAMIENTAS OEM	2 000033500 (1), 2000 003000 (2), 1860898 000 (3).
CÓDIGOS DE MOTOR	ALFA ROMEO 1,75 TBI: 939B1.000, 940A1.000, 940B2.000, 960A1.000 LANCIA 1,75 DI TURBO JET: 939B1.000

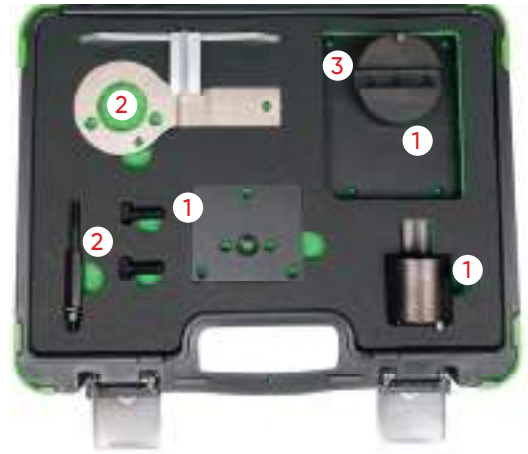
**54211**

74,00€

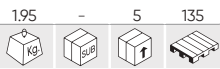
**KIT DE CALADO PARA FIAT/FORD/OPEL/SUZUKI 1.3L**

MARCAS	FIAT: PUNTO (2003-2007) / PANDA (2003-2009) / IDEA (2004-2006) / DOBLO (2004-2006). FORD: KA. VAUXHALL / OPEL: AGILA (2003-2008) / CORSA C (2003-2007) / CORSA D (2006-2009) / COMBO C (2003-2009) / ASTRA H (2004-2009) TIGRA B (2004-2009) / MERIVA (2004-2009). SUZUKI: IGNIS (2003-2009) / WAGON R (2003-2009) / SWIFT (2003-2010).
HERRAMIENTAS OEM	1871000200/303-1469/KM-662-C (1), EN 46785/KM 955/09912-38300 (2), 1871000900/1860985000/303-1472/EN 46781/09917-68610(3), 1870900400 (4), 1870900300 / 303-1468 (5)
CÓDIGOS DE MOTOR	FIAT: 1.3 JTD 188A9.000 / 169A.000 / 188A8.000 / 199A3.000. FORD: 1.3 TDCI. VAUXHALL / OPEL: 1.3 CDTI Z13DT / Z13DTH / Z13DTJ. SUZUKI: 1.3 CDTI Z13DT.

**54212**

39,40€

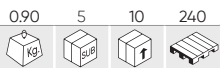
**KIT DE CALADO PARA FIAT/LANCIA 1.4 12V**

MARCAS	MAREA/MAREA_WEEKEND(96-20), BRAVA(95-98), BRAVO(95-98). LANCIA: YPSILON(96-20)
HERRAMIENTAS OEM	1860899000 (1), 1860901000 (2)
CÓDIGOS DE MOTOR	1.4 12V : 182A3.000, 182A5.000.



54215

57,00€

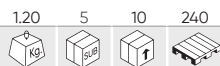

KIT DE CALADO PARA ALFA ROMEO/FIAT 1.4 MULTIAIR

MARCAS	ALFA ROMEO GIULIETTA, MITO / FIAT PUNTO, PUNTO EVO 1.4 (TURBO) MULTIAIR (105/135/163/170PS)
HERRAMIENTAS OEM	ALFA ROMEO / FIAT: 1860987000 (1), 2000034400 (2), 2000004500 (3)
CÓDIGOS DE MOTOR	940A2.000 / 940A2.000 / 955A8.000 / 955A8.000 / 940A2.000 / 955A8.000 / 955A2.000 / 955A7.000 / 955A6.000 / 955A8.000



54216

49,00€



KIT DE CALADO PARA FIAT/OPEL/ALFA 1.9, 2.4L 16V

MARCAS	OPEL 1.9, ALFA-ROMEO 1.9-2.4 L DIESEL, FIAT 1.9- 2.4 L DIESEL
HERRAMIENTAS OEM	OPEL EN-46788 / FIAT 1.860.905.000 / 1.860.905.010 (1) FIAT 1.860.898.000 (2) OPEL EN-46789 / FIAT 1.870.896.900 (3) OPEL KM 6130 / KM 6349 (4)
CÓDIGOS DE MOTOR	OPEL 1.9 CDTI Z19DT, Z19DTH, Z19DTJ ALFA-ROMEO 1.9 Y 2.4 L : 323.02, 371.01, 342.02, 325.01, 362.02, 182B9.000, 937A2.000, 937A3.000, 192A5.000, 192B1.000, 937A4.000, 937A5.000, 939A2.000, 939A1.000, 939A7.000, 939A8.000, 839A6.000, 841C.000 FIAT 1.9 Y 2.4 L : 182B4.000, 182B9.000, 185A6.000, 186A6.000, 186A8.000, 186A9.000, 188A2.000, 188A7.000, 188B2.000, 192A1.000, 192A3.000, 192A5.000, 192A8.000, 192A9.000, 192B4.000, 192B5.000, 198A2.000, 198A3.000, 198A6.000, 199A5.000, 223A7.000, 937A5.000, 939A1.000, 939A2.000, 939A3.000, 939A7.000



54430

34,00€



KIT DE CALADO ALFA ROMEO/FIAT/LANCIA 0.9 TWIN AIR

MARCAS	ALFA ROMEO: MITO (2001-2018) CHRYSLER: YPSILON (2011-2015) FIAT: 500/500C (2010-2020), 500L/500L LIVING/500L MPW (2012-2018), PUNTO (2012-2018), PANDA (2012-) LANCIA: YPSILON (2011-2018)
HERRAMIENTAS OEM	2 000 035 100 (1) 2 000 035 200 (2) 2 000 035 300 (3)
CÓDIGOS DE MOTOR	Q: 199B6.000, 199B7.000, 312A2.000, 312A4.000, 312A5.000, 312A6.000, 312A7.000



53259

97,00€

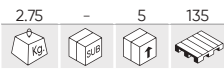

KIT DE CALADO BMW N42, N46 1.8, 2.0 CADENA

MARCAS	BMW 1 SERIES: 118I E81/82/87/88 (04-14), 120I E81/82/87/88 (04-14). BMW 3 SERIES: 316I/TI COMPACT E46 (01-07), 318I/TI COMPACT E46 (01-07), 318I, E90/91/92/93 (05-12), 320I E90/91/92/93 (05-12). BMW 5 SERIES: 520I E60/61 (07-10), Z4 2.0 E85/86 (04-09). BMW X SERIES: X1 SDRIVE 18I E84 (10-12), X1 XDRIVE 18I E84 (10-12), X3 2.0 E83 (05-10).
HERRAMIENTAS OEM	119350 (1), 119340 (2), 119291 (3), 119292 (4), 119270 (5), 115120 (6), 119190 (7), 119293 (8)
CÓDIGOS DE MOTOR	1.8: N42; B18A, N46; B18. / 2.0: N42; B20A, N46; B20, B20B, N46T; B20, B20B, B20BD, B20BZ, B20O2, B2O2.



53260

168,00€

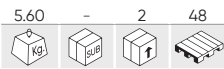

KIT DE CALADO BMW N43 1.6, 2.0 CADENA

MARCAS	BMW 1 SERIES: 116I E81/82/87/88 (07-12), 118I E81/82/87/88 (06-14), 120I E81/82/87/88 (06-14). BMW 3 SERIES: 316I E90/91/92/93 (07-11), 318I E90/91/92/93 (07-13), 320I E90/91/92/93 (07-14). BMW 5 SERIES: 520I E60/61 (07-10).
HERRAMIENTAS OEM	118690 (118691/118692/118693) (1), 118710 (118711/118712) (2), 113340 (3) (4), 118700 (5), 119340 (119341/119342) (6), 115120 (7).
CÓDIGOS DE MOTOR	1.6: N43 B16A/AA, B16AA, B16AA/OO. 2.0: N43 B20A, B20A/AA, B20AA, B20AY, B20KO, B20UO.

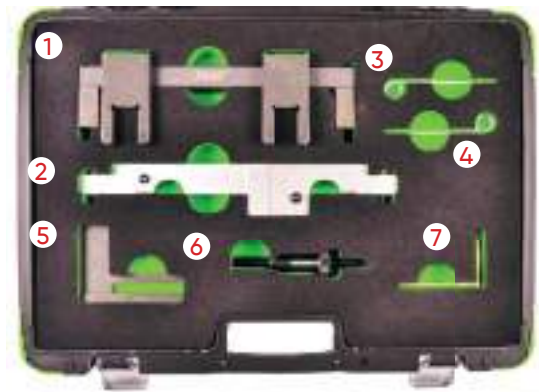

53261

214,00€

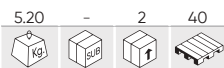

KIT DE CALADO BMW N42, N46 1.8, 2.0

MARCAS	BMW 1 SERIES: 118I E81/82/87/88 (04-14), 120I E81/82/87/88 (04-14). BMW 3 SERIES: 316I/TI COMPACT E46 (01-07), 318I/TI COMPACT E46 (01-07), 318I E90/91/92/93 (05-12), 320I (E90/91/92/93 (05-14). BMW 5 SERIES: 520I E60/61 (07-10). BMW X SERIES: X1 E84 SDRIVE 18I (10-12), X1 E84 XDRIVE 18I (10-12), X3 E83 2.0 (05-10). BMW Z SERIES: Z4 2.0 E85/86 (04-09).
HERRAMIENTAS OEM	119190 (1), 119310 (2), 119302 (3)
CÓDIGOS DE MOTOR	2.0: N42 B18A, N42 B20A, N46 B18, N46 B20, N46 B20B, N46T B20, N46T B20B, N46T B20BD, N46T B20BZ, N46T B20O2, N46T B2O2



KITS DE CALADO (TIMING TOOLS)

53262

251,00€

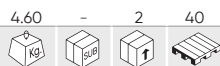

KIT DE CALADO ÁRBOL DE LEVAS BMW M52TU, M54, M56 DOBLE VANOS

MARCAS	<p>M52TUB25: 1997-2001 E46 323i/323Ci/323Ti (M52T); 1998-2001 E39 523i (M52TU); 1998-2001 E36/7 Z3 (M52TU).</p> <p>M52TUB28: 1997-2001 E46 328i/328Ci (M52TU); 1997-2001 E36/7 Z3 2.8 (M52B28/Z3); 1998-2001 E39 528i (M52TU); 1998-2001 E38 728i (M52TU).</p> <p>M54B22: 2001-2003 E46 320i/320Ci; 2001-2003 E39 520i; 2001-2002 E36 Z3 2.2i; 2003-2005 E85 Z4 2.2i; 2003-2005 E60/E61 520i.</p> <p>M54B25: 2001-2002 E36/7 Z3 2.5i; 2001-2005 E46 325i/325Xi; 2001-2006 E46 325Ci; 2001-2004 E46 325Ti; 2001-2004 E39 525i; 2003-2004 E60/E61 525i/525Xi; 2004-2006 E83 X3 2.5i; 2004-2006 E85 Z4 2.5i.</p> <p>M54B30: 2001-2005 E46 330i/330Xi; 2001-2006 E46 330Ci; 2001-2003 E39 530i/2001-2002 E36 Z3 3.0i; 2003-2005 BMW E60 530i; 2003-2006 E85 Z4 3.0i; 2001-2006 E53 X5 3.0i.</p>
HERRAMIENTAS OEM	116150 (1), 113450 (2), 113292 (3), 116180 (4), 114220(5)

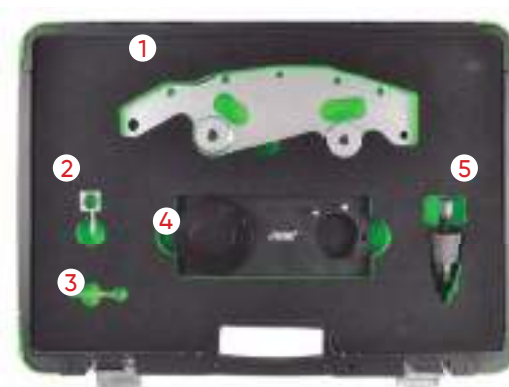

53263

57,00€

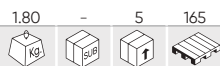

KIT BLOQUEO ÁRBOL DE LEVAS BMW M47 LAND ROVER TD4,TD6

MARCAS	<p>BMW 1 SERIES: 118D E87 (04-07), 120D E87 (04-07).</p> <p>BMW 3 SERIES: 318D/TD COMPACT E46 (01-05), 318D/TD E90/91 (05-08), 320D/TD COMPACT E46 (98-05), 320D/CD E90/91 (05-08), 325D E90/91/92/93 (02-10), 330D/CD E46/90/91/92/93 (99-07), 335D E90/91/92 (06-11).</p> <p>BMW 5 SERIES: 520D E39/60/61 (00-09), 525D/XD E39/60/61 (00-10), 530D/XD E46/60/61 (98-10), 535D E60/61 (04-10).</p> <p>BMW 6 SERIES: 635D E63/64 (07-11).</p> <p>BMW 7 SERIES: 730D/LD E38/65/66 (98-08).</p> <p>BMW X SERIES: X3 2.0D E83 (04-07), X3 3.0D/SD E83 (03-10), X5 3.0D E53/E70 (00-10), X6 3.0D E71/72 (08-10), X6 3.5D E71/72 (08-10).</p> <p>LAND ROVER: FREELANDER TD4 (00-06), RANGE ROVER TD6 (02-06).</p> <p>MG/ROVER: MG-ZT/T (01-05), ROVER 75 CDT/CDTI (99-05).</p> <p>VAUXHALL/OPEL: OMEGA-B (01-03).</p>
HERRAMIENTAS OEM	112300/12-108, 12-171/KM-813 (1), 113340/12-172/KM-823 (2) (3), 116322/12-174/KM-6267 (4) 116320 (5)
CÓDIGOS DE MOTOR	<p>BM - 2.0D: M47, M47T2, M47TU / 2.5D: M57, M57T2, M57TU / 3.0D: M57, M57T2, M57TU</p> <p>LAND ROVER - 2.0D: 204D3 (TD4) / 3.0D: 306D1 (TD6)</p> <p>MG/ROVER- 2.0D: M47R / 2.0D CDT: M47R</p> <p>VAUXHALL/OPEL- 2.5D: Y25DT</p>



53264

143,00€



KIT DE CALADO BMW N62,N73

MARCAS	<p>BMW 5 SERIES: 540i E60/61 (05-10), 545i E60/61 (03-06), 550i E60/61 (05-10).</p> <p>BMW 6 SERIES: 645i E63/64 (03-06), 650i E63/64 (05-11).</p> <p>BMW 7 SERIES: 735i E65/66 (02-05), 740i E65/66 (05-10), 745i E65/66 (02-05), 750i E65/66 (05-08), 760i E65/66 (02-08).</p> <p>BMW X SERIES: X5 4.4 E53 (03-07), X5 4.8 E53/E70 (04-10).</p>
HERRAMIENTAS OEM	119463 (1), 119462 (2), 119340 (3), 119461 (4), 119190 (5)
CÓDIGOS DE MOTOR	<p>3.6 V8: N62 B36A 4.4 V8: N62 B44A 6.0 V12: N73 B60A</p> <p>4.0 V8: N62 B40A 4.8 V8: N62 B48B</p>

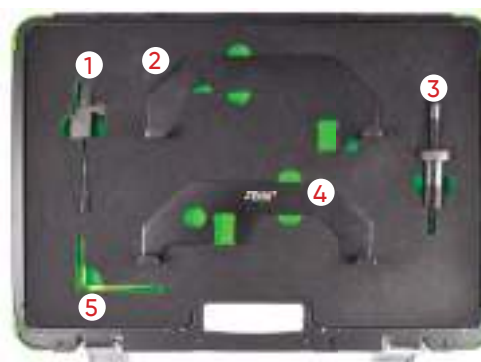

53265

195,00€

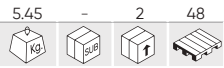

KIT DE CALADO BMW DIESEL M47, M57, M41, M51

MARCAS	BMW
HERRAMIENTAS OEM	113360 (1), 116321 (2), 135190 (3), 135191 (4), 135192 (5), 116322 (6), 112300 (7), 113340 (8)
CÓDIGOS DE MOTOR	M41 / M51 / M47TU / M47TU T2. M57TU T2 3.01 1998 - 2008.

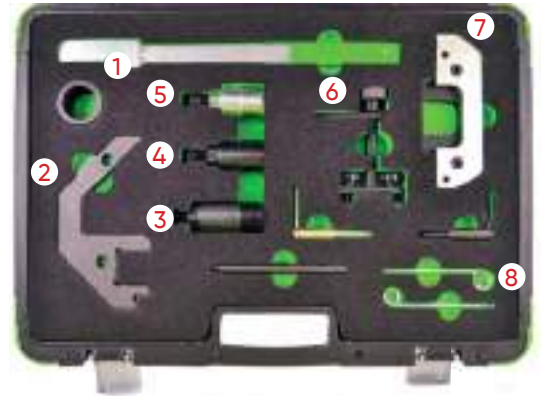
**53266**

224,00€

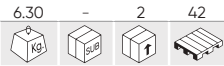

KIT DE CALADO BMW M42, M43, M50, M51, M52

MARCAS	BMW
HERRAMIENTAS OEM	113240 (1), 115490 (2), 113190 (3), 112300 (4) (5), 113292 (6), 113320 (7)
CÓDIGOS DE MOTOR	PETROL: M42, M43, M50, M52, M60. DIESEL: M51

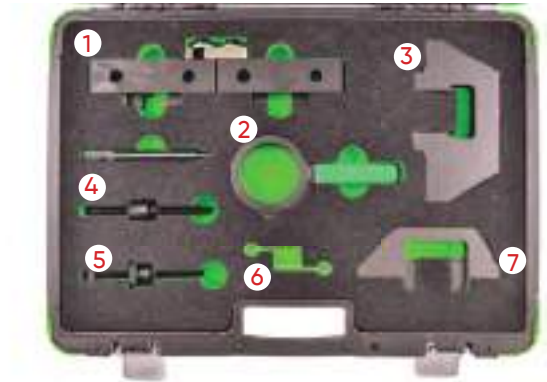
**53267**

277,00€

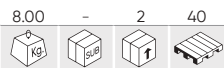

KIT DE CALADO BMW M40, M43, M42, M44, M52, M54, M56

MARCAS	BMW SERIES: 3, 5, 7, X, Z
HERRAMIENTAS OEM	114220 (1), 112300 (2), 113240 (3), 115490 (4), 113292 (5), 113450 (6)
CÓDIGOS DE MOTOR	M40. M44. M50. M52. M54. M56.



53269

50,00€

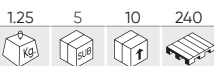

KIT DE CALADO BMW N47, N47S, N57

MARCAS	<p>BMW 1 SERIES: 116D E81/82/87/88 (08-12), 118D E81/82/87/88 (07-14), 120D E81/82/87/88 (07-14), 123D E81/82/87/88 (07-14). BMW 2 SERIES: 218D (11-14), 220D (11-14), 225D (11-14). BMW 3 SERIES: 316D E90/91/92/93 (09-12), 318D E90/91/92/93 (07-12), 320D E90/91/92/93 (07-12), 325D E90/91/92/93 (10-14), 330D/XD E90/91/92/93 (08-14). BMW 5 SERIES: 520D E60/61 (07-10), 525D F10/11 (10-12), 530D F10/11 (10-13), 530DGT F07 (09-12), 535D F10/11 (10-17), 535DGT F07 (10-12). BMW 7 SERIES: 730D/LD F01/02/04 (08-12), 740D F01/02/04 (09-12), 740D XDRIVE F01/02/04 (09-12), 750D XDRIVE F01/02/04 (12-15). BMW X SERIES: X1 SDRIVE 18D E84 (09-15), X1 SDRIVE 20D E84 (09-12), X1 XDRIVE 18D E84 (09-15), X1 XDRIVE 20D E84 (09-15), X1 XDRIVE 23D E84 (09-12), X3 2.0D E83 (07-10), X3 XDRIVE 18D E83 (08-10), X3 XDRIVE 30D E83 (11-12), X3 XDRIVE35D F25 (11-17), X5 3.0D E70 (10-13), X5 XDRIVE 40D X5 F15 M50D (13-17), E70 (10-13), X6 XDRIVE 30D E71/72 (10-14), X6 XDRIVE 40D E71/72 (10-14), X6 F16 M50D (14-17). BMW MINI: PACEMAN (13-17), COUNTRYMAN (10-17), MINI (10-15), ROADSTER (12-14), CLUBMAN (10-14), CLUBVAN (12-14).</p>
HERRAMIENTAS OEM	118760 (1), 118740 (2), 116480 (3), 115320 (4)
CÓDIGOS DE MOTOR	<p>1.6 D: N47; C16K1, C16U1. 2.0 D: N47; C20K1, C20U1N47; D20, D20A, D20B, D20D, D20K1, D20O0, D20O1, D20T1, D20U0, D20U1, N47S D20T0, N47T; D20, D20O1, D20U1. 3.0 D: N57; B30B, B30B/T0, B30C, D30BT0, D30O0, D30O1, D30T0, D30T1, D30U0.</p>

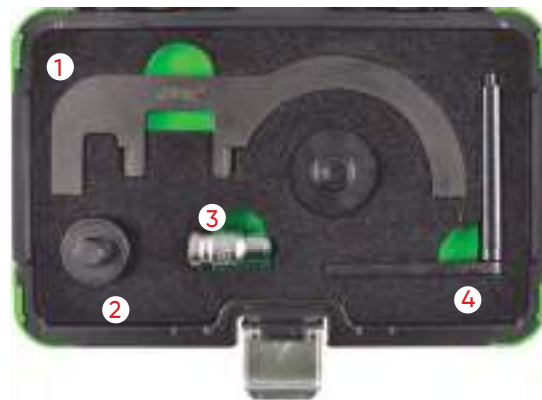

54206

113,00€



KIT DE CALADO PARA BMW/MINI 1.5 , 2.0L

MARCAS	<p>BMW - 1 SERIES - 114D, 116D, 214D - (F20/ 21) - (2015- 2017) - 2 SERIES - 216D, 118D, 125D - (F22/ 23/ 45/ 46) - (2014-2017) - 3 SERIES - 218D, 220D, 225D - (F30/31/34) - (2015-2017) - 4 SERIES - 316D/320D/325D - (F32, 33, 36) - (2015-2017) - 5 SERIES - 420D, 425D, 418D - (F10, 11) - (2014-2017) - X1 SERIES - 518D - (F48) - (2015-2017) - X3 SERIES - (F25) - (2014-2017) - EFFICIENT DYNAMICS - X4 SERIES - (F26) - (2014-2017) - XDRIVE - X5 SERIES - (F15) - (2015-2017) - SDRIVE MINI - CLUBMAN - (F54) - (2015-2017) - ONE D CONVERTIBLE - (F57) - (2016-2017) - COOPER D/ SD MINI HATCH (F55, 56) - (2014-2017)</p>
HERRAMIENTAS OEM	114120 (1), 2347904 (2), 2365488 (3), 2288380 (4), 118760 (5), 118740, 118030 (6)
CÓDIGOS DE MOTOR	<p>1.5: B37 D15A, B37 C15A 2.0: B47 D20A, B47 D20B, B47 C20A, B47, B47 C20B</p>

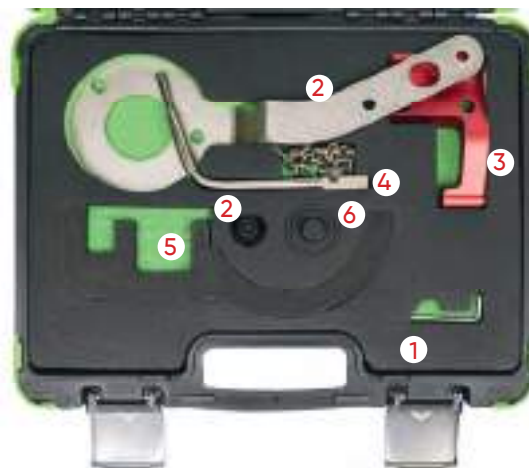

TU KIT DE CALADO AÚN MÁS CERCA

INTRODUCE EN TU BUSCADOR WEB EL CÓDIGO DE LAS HERRAMIENTAS OEM O EL CÓDIGO MOTOR DE TU COCHE Y ENCUENTRA TU KIT DE CALADO COMPATIBLE

54219

60,00€

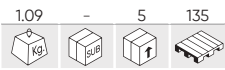

KIT DE CALADO PARA BMW/MINI/CITROËN/PEUGEOT

MARCAS	BMW MINI PSA
HERRAMIENTAS OEM	115140 (1), 119280 (2), 119330 (3), 113340 (4), 114360 (5)
CÓDIGOS DE MOTOR	BMW 1.6 (N40 / N45 / N45T, B16, B16A, B16AC) 1.8 / 2.0 (N42 / N46 / N46T) 2.0 / 3.0 (N51 / N52 / N52-COMPONENTE / N53 / N54) PSA 1.4 / 1.6 16V (EP3 / EP6 / EP6DT / EP6DTS) MINI 1.4 / 1.6 (N12 / N14)



54222

59,00€

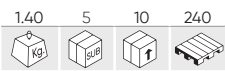

KIT DE CALADO PARA MINI 1.6

MARCAS	BMW: MINI COOPER S(07-10) PEUGEOT: 207(06-10), 307(06-10), GT(06-10), THP(06-10), GTI(06-10) CITROËN: DS3(06-10), C4(06-10), GRANDE PICASSO TPH(06-10)
HERRAMIENTAS OEM	119550(1), 119551(2), 119552(3), 119590(4)
CÓDIGOS DE MOTOR	N14 B16A , N14 B16CD , N14 B16TO

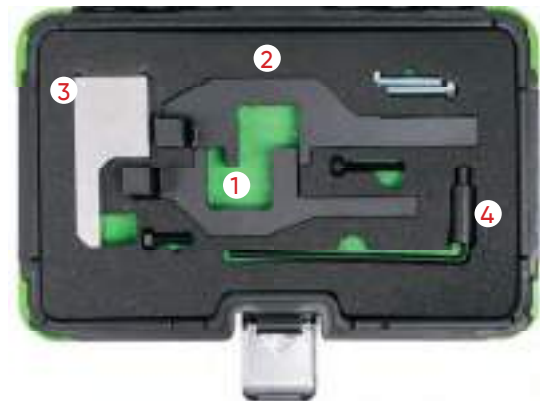

54227

122,00€



KIT DE CALADO PARA BMW/MINI N13, N18, PSA

HERRAMIENTAS OEM	EN-52127-2, EN-52588, E1 100, G 1376A, T10550/2, T10550/3, 0 496 709, 0109 2B, 0197 A11, 0197 A3, 0197 A31, 0197-A1, 0197-A1Z, 0197-A11, 0197A2, 0197-A31, 0197-A32, 0197-A33, 0197-BZ, 0197-M, 0197-N, 11 7 440 (1), 11 9 340 (2), 11 9 540, 11 9 551, 11 9 590, 1376-A, 2 299 362 (3)
CÓDIGOS DE MOTOR	N12 B14A, N13 B16A, N14 B16A, N14 B16C, N16 B16A, N18 B16A, N18 B16C, 5FA (EP6CDT), 5FD (EP6DTS), 5FE (EP6CDT), 5FE (EP6CDTM), 5FF (EP6DTS), 5FG (EP6CDTR), 5FH (EP6C), 5FK (EP6C), 5FK (EP6CB), 5FL (EP6C), 5FM (EP6CDTM), 5FN (EP6CDT), 5FP (EP6), 5FR (EP6DTE), 5FS (EP6C), 5FT (EP6DT), 5FU (EP6CDTX), 5FV (EP6CDT), 5FW (EP6), 5FX (EP6DT), 5FY (EP6DTS), 5GF (EP6FADTX), 5GF (EP6FADTXD), 5GG (EP6FADTX), 5GM (EP6FDTX), 5GN (EP6FDTR), 5GP (EP6FDTR), 5GR (EP6FDTX), 5GT (EP6FDTX), 5GW (EP6FDT), 5GY (EP6FADTXD), 5GY (EP6FDT), 5GY (EP6FDTM), 5GZ (EP6FDT), 8FN (EP3C), 8FP (EP3C), 8FR (EP3C), 8FS (EP3)

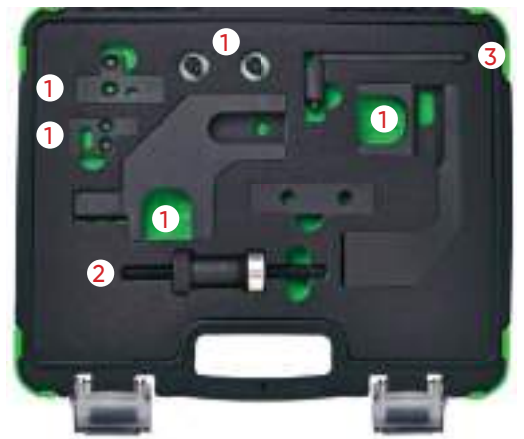

54228

187,00€



KIT DE CALADO PARA BMW/MINI 1.2, 1.5, 2.0, 3.0

MARCAS	BMW: 1 SERIES (2015 - 2019), 2 SERIES (DESDE 2014), 3 SERIES (DESDE 2015), 4 SERIES (DESDE 2015), 5 SERIES (DESDE 2017), 6 SERIES (DESDE 2017), 7 SERIES (DESDE 2015), i8 (DESDE 2014), X1 (DESDE 2015), X2 (DESDE 2018), X3 (DESDE 2017), X4 (DESDE 2018) AND Z4 (DESDE 2019); MINI: CLUBMAN (DESDE 2015), HATCH (DESDE 2014), CONVERTIBLE (DESDE 2016) AND COUNTRYMAN (DESDE 2017)
HERRAMIENTAS OEM	2 358 122 (1), 2 357 904 (2), 2 365 488 (3), 2 288 380 (4), 11 4 120 (5).
CÓDIGOS DE MOTOR	BMW: 1,5 B38 A15A, B38 B15A, B38 K15A ,1,6 B48 B16A, 2,0 B48 A20A, B48 A20B, B48 A20E, B48 B20A, B48 B20B , 3,0 B58 B30A, B58 B30B, B58 B30C MINI: 1,2 B38 A12A , 1,5 B36 A15A, B38 A15A , 2,0 B46 B20A, B48 A20A, B48 A20B



54293

17,50€



POSICIONADOR DE CIGÜEÑAL PARA BMW

MARCAS	BMW 1 SERIES E81/82/87/88: 116D (2008-2012),118D (2007-2012),120D (2007-2014), 123D (2007-2014) BMW 1 SERIES E22: 218D (2011-2014), 220D (2011-2014), 225D (2011-2014) BMW 3 SERIES E90/91/92/93: 316D (2007-2012), 318D (2007-2014),320D (2007-2012), 325D (2010-2012), 330D (2008-2014) BMW 5 SERIES E60/61: 520D (2007-2010) BMW 5 SERIES F10/11: 525D (2010-2013), 530D (2010-2013),530D XDRIVE (2011-2015), 535D (2010-2013), 535D XDRIVE (2011-2015),M550D XDRIVE (2012-2015) BMW 5 SERIES F07: 535D GT (2009-2015) BMW 7 SERIES F01/02/04: 730D (2008-2012), 740D (2009-2012),750D XDRIVE (2012-2015) BMW X1 E84: 18D SDRIVE (2009-2015), 20D SDRIVE (2009-2015), 18D XDRIVE (2009-2015), 20D XDRIVE (2009-2015), 23D XDRIVE (2009-2012) BMW X3 E83: 2.0D (2007-2008), 18D XDRIVE (2008-2010) BMW X5 E70: 3.0D XDRIVE (2010-2013), 40D (2010-2013) BMW X6 E71/71: 30D XDRIVE (2010-2014), 40D XDRIVE (2010-2014)
HERRAMIENTAS OEM	T10016
CÓDIGOS DE MOTOR	2,0: N47D20C, N47D20D 2,0D: N47, D20A, D20A/KO, D20B, D20B/TO, D20C,D20O0, D20O1, D20U0, D20U1 D20K1 3,0D: N57, D30U0, D30O0, D30O1, D30T0, D20T0,D30A, D30A/O0, D30B , D30B/T1, D30C, D30C/S1,D30A0/O0, D30A0/O1



54398

41,00€



KIT DE BLOQUEO Y GIRO DEL CIGÜEÑAL BMW/MINI

MARCAS	MINI HATCH (14-21), CABRIOLET (16-19), CLUBMAN (15-19), COUNTRYMAN (17-19)
HERRAMIENTAS OEM	11 6 480 (1) 11 9265 (2) 11 4 180 (3) 11 9 810 (4) 11 9 811 (4)
CÓDIGOS DE MOTOR	BMW: 116i (15-19), 116d (15-19), 118d (15-19), 120d (15-19), 125d (15-19), M140i (16-19), 214d (15-19), 216i (18-19), 216d (14-20), 218d (17-19), 218i (15-21), 220d, (14-20), 225d (15-20), M240i (16-19), 316d (15-19), 318i (15-19), 320d (15-19), X1 (15-20),X2 (18-19), X3 (14-18), X4 (17-20), X5 (15-18), i8 (14-18) 325d (16-20),330i (15-20), 340i (15-19), 418i (15-20), 420d (15-20), 425d (16-18), 430i (16-20),440i (16-19), 518d (14-17), 525d (17-20), 530i (17-18), 540i (17-19), 620d (18-20), 630i (17-19), 640i (17-19), 725d (16-19), 730i, (15-19), 740i (15-19)



54399

56,50€



N

KIT DE CALADO BMW/ROVER/OPEL 2.5D

MARCAS	BMW: 318TDS (94-00), 325TD (91-99), 325TDS (91-99), 525TD (90-03), 525TDS (90-03), 725TDS (95-02) RANGE ROVER: P38 (94-02) VAUXHALL/OPEL: OMEGA-B (94-01)
HERRAMIENTAS OEM	KM811 (1), 113320 (1), 12112 (1) KM822 (2), 113360 (2), 12115 (2) KM813 (3), 115120 (3), 112300 (3), 12108 (3) KM823 (4), 113340 (4), 12172 (4)
CÓDIGOS DE MOTOR	256T, 25DT, M41/174T1, M51/256T1, M51/256T1L, X25DT



54400

141,00€



N

KIT DE CALADO BMW N20, N26

MARCAS	BMW: 1 SERIES 125I - F20/21 (2012-2016) 2 SERIES COUPE 220I, 228I - F22 (2014-2016) 2 SERIES CABRIOLET 220I 228I - F23 (2015-2016) 3 SERIES 320I 328I XDRIVE - F30/31 (2012-2015) 3 SERIES GRAN TURISMO 320I, 328I/XDRIVE - F34 (2013-2016) X4 XDRIVE 20I, 28I (F26) 2014 - 2018, X5 XDRIVE40E (F15) 2015 - 2018, Z4 SDRIVE18I, 20I, 28I (E89) 2011 - 2017 4 SERIES COUPE 420I, 428I/XDRIVE - F32(2013-2016), 4 SERIES CABRIOLET 420I, 428I/XDRIVE-F33 (2014-2016) 4 SERIES GRAN COUPE 420I, 428I/XDRIVE F36 (2014-2016) 5 SERIES 520I, 528I/XDRIVE(F10/11) 2010 - 2017, 5 SERIES GRAN TURISMO 528I-(F07) 2013 - 2016, X1 SDRIVE16I, 18I, 20I, XDRIVE20I, 28I-(E84) 2011 - 2015, X3 SDRIVE18I, 20I, XDRIVE20I, 28I (F25) 2011 - 2017
HERRAMIENTAS OEM	11 9 340/341 (1), 11 9 340A (1), 11 9 341 (1), 119340 (1) 2 212 830 (2) 2 212 831 (3) 2 219 548 (4)
CÓDIGOS DE MOTOR	1,6 N20 B16A 2,0 N20 B20 N20 B20A N20 B20A N20 B20B N20 N20B/UO N20 B2000 N20 B2000 N26 B20 B26 B20A

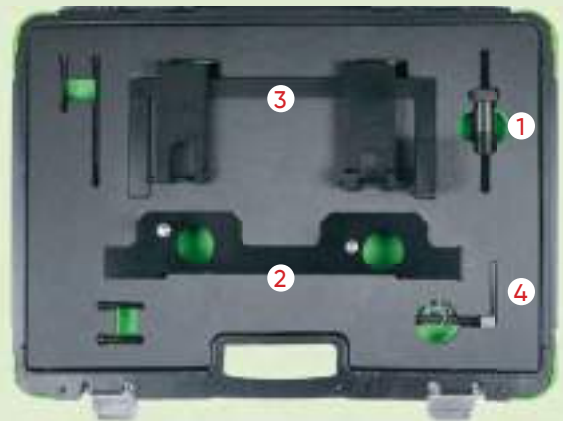

54401

57,00€



N

KIT DE CALADO BMW/MINI N13, N18

MARCAS	BMW 114I (2012-2015) BMW 116I (2012-2015) BMW 118I (2011-2015) BMW 316I (2012-2015) MINI CLUBMAN (R55) (2011-2014) MINI COOPER S (R56/57) (2010-2015) MINI COUNTRYMAN (R60) (2012-2016) MINI COUPE COOPER S (R58) (2012-2015) MINI PACEMAN (R61) (2013-2017) MINI ROADSTER (R59) (2012-2015)
HERRAMIENTAS OEM	11 7 440 (1), 117440 (2), 11 9 340 (3), 11 9 590 (4), 49 6 709 (5)
CÓDIGOS DE MOTOR	N13 B16A N18 B16A N18 B16/MO N18B16A/MO N18B16C N18B16C/TO N18B16MO



KITS DE CALADO (TIMING TOOLS)

54402

201,00€



N

KIT DE CALADO BMW N51, N52, N53, N54, N55

MARCAS	E60: 523i, 523Li, 525i, 525Li, 525Xi, 528i, 528Xi, 530i, 530Li, 530Xi, 535i, 535Xi E61/E63: 523i, 525i, 525Xi, 530i, 530Xi, 535Xi, 630i E64/E65: 630i, 730i E66/E70: 730Li, X5 3.0Si E81/E82: 130i, 135is E83: X3 2.5i, 2.5Si, 3.0i, 3.0Si E85/E86: Z4 2.5i, 2.5Si, 3.0i, 3.0Si, Z4 3.0Si E87/E90: 130i, 323i, 325i, 325Xi, 328i, 328Xi, 330i, 330Xi, 335i, 335Xi E91: 323i, 325i, 325Xi, 328i, 328Xi, 330i, 330Xi, 335i, 335Xi E92: 323i, 325i, 325Xi, 328i, 328Xi, 330i, 330Xi, 335i E93: 325i, 328i, 330i, 335i
HERRAMIENTAS OEM	110300 (1) 114280 (2) 114285 (3) 114290 (4) 114390 (5) 118520 (6) 119190 (7) 119340 (8)
CÓDIGOS DE MOTOR	N51/N52/N53/N54/N55

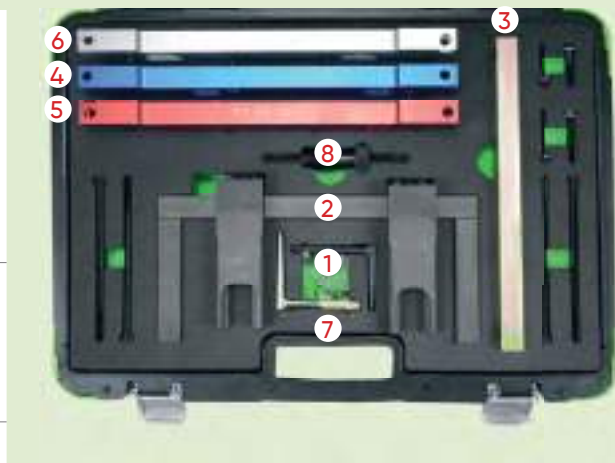

54403

225,00€



N

KIT DE CALADO BMW M60

MARCAS	BMW 5 SERIES: 530i, 540i (E34) (1992 – 1996), 535i, 540i (E39) (1996 – 2003) BMW 7 SERIES: 730i, 735i, 740i (E38) (1994 – 2002), 730i, 740i (E32) (1992 – 1994) BMW 8 SERIES: 840i (E31) (1993 – 1999) LAND ROVER/RANGE ROVER: (L322) (2002 – 2005) X5: 4.4, 4.6 (E53) (1999 – 2004)
HERRAMIENTAS OEM	11 2 445 (1), 11 2 441/445 (1), LRT -12 223/2 (1) 11 2 441 (2), 12 223/1 (2), LRT 12-223/1 (2) 11 2 442 (3), 11 2 442/446 (3), 12 223/3 (3), LRT 12 223/3 (3) 11 2 446 (4), 12 223/4 (4), LRT 12 223/4 (4), LRT 12 224 (4) 11 3 390 (5), 113390/117380 (5), 12 222 (5), LRT 12 222 (5) 11 5 180 (6), 12 227 (6), LRT 12 227 (6) 11 2 300 (7), 11 5 120 (7), 12 108 (7), 12 171 (7), KM 813 (7), LRT 12 108 (7), LRT 12 171 (7) 11 6 420 (8), 12 226 (8), LRT 12 226 (8) 11 6 452 (9), 12 228/1 (9), LRT 12 228/1 (9) 11 6 451 (10), 12 228/2 (10), LRT 12 228/2 (10) 11 3 310 (11), 12 220 (11), LRT 12 220 (11) 11 6 440 (12), 12 224 (12), LRT 12 2214 (12) 11 7 380 (13), 12 221 (13), LRT 12 221 (13)
CÓDIGOS DE MOTOR	BMW 3.0: 30 8S 1 BMW 3.5: 35 8S 1, 35 8S 2 BMW 4.0: 40 8S 1 BMW 4.4: 44 8S 1, 44 8S 2 BMW 4.6: 46 8S 1 RANGE ROVER: V8/44 8S 2



54404

131,00€



N

KIT DE CALADO BMW N62, N73

MARCAS	SERIES 5, SERIES 6, SERIES 7, X5
HERRAMIENTAS OEM	119461 (1), 119462 (2), 119463 (3), 119190 (4), 119340 (5), 119451 (6), 119452 (7), 119453 (8), 119454 (9), 113460 (10), B117207 (11)
CÓDIGOS DE MOTOR	N62 B36A, N62 B40A, N62 B44A, N62 B48A, N62 B48B, N73 B60A



54405

111,00€

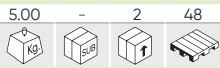

N

KIT DE CALADO BMW N63, N74

MARCAS	SERIES 5, SERIES 6, SERIES 7, X5, X6
HERRAMIENTAS OEM	11 9 891 (1) 11 9 892 (1) 11 9 893 (2) 11 9 190 (3) 11 8 090 (4)
CÓDIGOS DE MOTOR	N63, N74

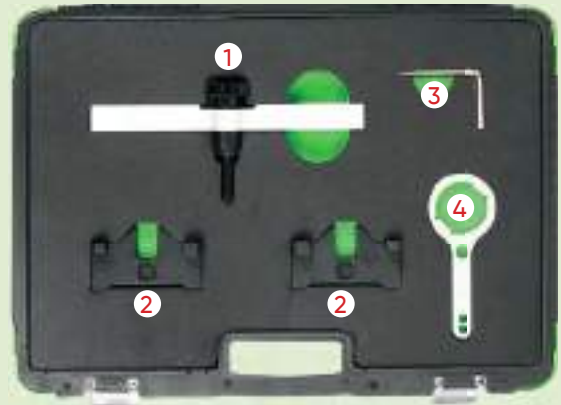

54406

73,00€



N

BLOQUEADOR DE VOLANTE DE MOTOR BMW/MINI

MARCAS	<p>BMW 1 SERIES: F20/21 (12-15), 116i (04-12), 118i (04-14), 120i (04-14), 130i (05-07), 135i (07-11), 116D (08-12), 118D (04-14), 120D (04-14), 123D (07-14), M COUPE (11-12)</p> <p>BMW 3 SERIES: F30/31 (12-15), 316Ti (04-14), 316i (04-11), 316D (09-12), 318i (04-07), 318Ti/COMPACT (04-04)</p> <p>BMW 3 SERIES: 318D (03-12), 318TD (03-07), 320D (01-07), 320D COMPACT (01-05), 318i (05-13), 320D (07-14), 320i (05-14), (05-14), 320Si (05-06)</p> <p>BMW 3 SERIES: 323i (05-11), 325i (05-14), 325D (06-10), 330D (05-08), 330i (06-13), 335D (05-13), 335i (05-11)</p> <p>BMW 4 SERIES: 420i F32 (13-15), 428i F32 (13-15), 420i F33 CABRIOLET (14-15), 428i F33 CABRIOLET (14-15), 420i F36 (14-15), 428i F36 GRAN COUPE (14-15)</p> <p>BMW 5 SERIES: F10/11 (10-15), 520D (05-10), 520i (07-10) 523i (03-10), 525D (05-10), 525i (05-10), 525i (07-10), 530D (03-10), 530i (05-10), 535D (04-10)</p> <p>BMW 6 SERIES: 630i (04-11), 635D (07-11)</p> <p>BMW 7 SERIES: 730D (05-08), 730i (02-08) BMW X SERIES: X1 E84 (09-15), X3 E83 (03-14), X5 E53 (03-14), X3 F25 (11-15), X6 E71/72 (08-10)</p> <p>BMW Z SERIES: Z4 E85/86 (04-09), Z4 (E89) (11-15)</p> <p>MINI: MINI (03-06)</p>
HERRAMIENTAS OEM	11 8 180 (1), 11 8 181 (2), 11 8 182 (3), 11 8 183 (4), 11 8 184 (5), 11 8 185 (6)
CÓDIGOS DE MOTOR	BMW: M47T2, M57T2, M67, N43, N45, N45T, N46, N46T, N47, N51, N52, N53, N54 MINI: W17 DIESEL



54324

11,00€



N

INDICADOR DE DESGASTE DE LA CADENA DE DISTRIBUCIÓN MINI

MARCAS	MINI: CLUBMAN (2007-2014), CLUBVAN (2012-2014), COUNTRYMAN (2010-2017), COUPÉ (2011-2015), MINI (2006-2015), PACEMAN (2013-2017), ROADSTAR (2012-2015)
HERRAMIENTAS OEM	2353281 (1)
CÓDIGOS DE MOTOR	1.4: N12 B14AB, N12 B14 1.6: N12 B16A, N16 B16A, N16 B16M0, N16 B16U0, N16 B16A/MO, N16 B16KO, N16 B16A/MO, N18 B16A, N18 B16A/MO, N18 B16C, N18 B16A/MO, N18, N18 B16M0, N18 B16C/T0



53268

92,00€



KIT DE CALADO BMW/MINI/PSA 1.4, 1.6

MARCAS	BMW/MINI: MINI CLUBVAN R55 (12-14), MINI CLUBMAN R55 (08-14), MINI COUNTRYMAN R55 (07-10), MINI CLUBMAN R56/R57 (07-15), MINI R56/R57 (08-15), MINI COUPE R58 (11-15), MINI ROADSTER R59 (08-15), MINI CLUBMAN R60 (10-14), MINI CLUBVAN R60 (12-14), MINI ROADSTER R61 (13-15), MINI PACEMAN R61 (14-15), MINI COUNTRYMAN R60 (10-17). CITROËN: C4 (08-11), C4 PICASSO (08-13) C4 GRAND PICASSO (13-15). PEUGEOT: 207 (06-14), 207CC (07-15), 308 (07-15), 3008 (09-15), 5008 (09-15).
HERRAMIENTAS OEM	BMW/MINI: 115590 (1), 119340 (2), 119551 (3) CITROËN: 0197-A1, 0197-A3, 0197-B. PEUGEOT: 0197-A1, 0197-A3, 0197-BZ.
CÓDIGOS DE MOTOR	1.4: N12B14, N14B14AB. 1.6: EP3(8FS), EP3C(8FR), EP6(5FW), EP6C(5FS), EP6CDT(5FV), EP6DT(5FT), EP6DT(5FX), EP6DTS(5FY), N14B16A, N14B16CD, N14B16TO, N14B16CD/TO, N16B16A, N16B16KO, N16B16A/MO, N16B16A/MO, N16B16MO, N16B16UO.



53313

139,00€

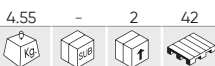

KIT DE CALADO CITROËN/PEUGEOT

MARCAS	CITROËN: AX, BX, BOXER, BERLINGO, C25, DISPATCH, EVASION, J5, JUMPY, JUMPER, RELAY, SAXO, SYNERGIE, VISA, XM, XSARA, XANTIA, XZ, ZX. PEUGEOT: 106, 205, 206, 305, 306, 307, 309, 405, 406, 605, 607, 806, EXPERT, PARTNER, SOLARA, TALBOT.
HERRAMIENTAS OEM	7099TM (1), 0188X (2), 0188P (3), 0189AZ (4), 0188H (5), 0132AJ1 (6), 0189A (7), 0188PM (8), 21-260 (9), 4527-TS1 (10), M8X70 (11), 0188K (12), 0188J (13), 0132Q (14), 4507-TL (15), 4507-TJ (16), 9044-T (17), 4507-TJ (18), 5711-TA (19), 7014-TJ (20), 7017-TR (21), 0188X (22), 7017-TW (23), 7014-TM (24), 0189L (25)

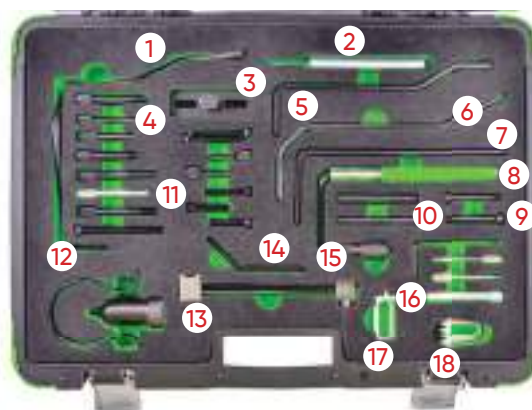

53314

98,00€

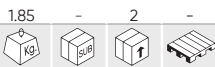

KIT DE CALADO CITROËN/PEUGEOT 1.8, 2.0

MARCAS	CITROËN: C4 PICASSO/GRAND PICASSO (06-10), C5 II (04-08), C8 (05-10), DISPATCH/JUMPY (07-11), XSARA 2.0 16V, C5 1.8/2.0/HPI, XSARA PICASSO 1.8/2.0 16V (02-05). PEUGEOT: 406 1.8 16V (00-04), 407 (06-10), 807 2.0 16V (02-05).
HERRAMIENTAS OEM	0189S2 (1), 0188J (2), 0188J2 (2), 0189S1 (3), 21-260 (4), 0189B (5), 0188M (6), 0188AH (7), 0189R (8)
CÓDIGOS DE MOTOR	1.8 16V: EW7A(6FY). 2.0 16V: EW10A(RFJ), EW10ABE4(RFH), EW10J4S (RFK).

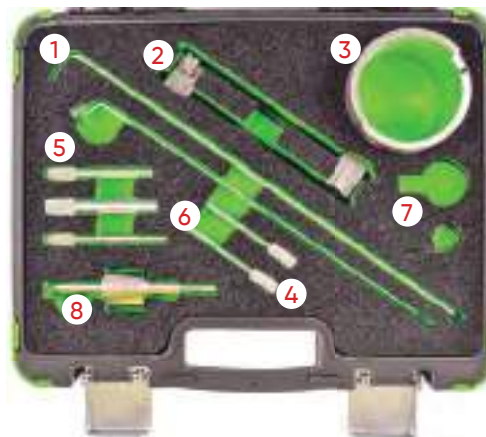

53876

64,00€

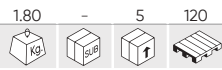

KIT DE CALADO PARA CITROËN/PEUGEOT 1.0, 1.2 VTI

MARCAS	CITROËN: C3 (III) PEUGEOT: 208, 308, 2008 SUV (2012-2014)
HERRAMIENTAS OEM	0109-2A (1) 0109-2B (2)
CÓDIGOS DE MOTOR	1.0/1.2 VTI. EBO, (ZMZ), EB2, (HMZ)



54288

72,50€



KIT DE CALADO PSA 1.2 GDI PURETECH

MARCAS	CITROËN: BERLINGO IV (18-20), C1 II (14-18), C3 III (12-17), C3 IV (16-18), C4 CACTUS (14-20), C4 AIRCROSS (18-20), C-ELYSEE (12-18), DS3 (12-18) PEUGEOT: 108 (14-18), 208 (12-21), 2008 (13-21), 301 (12-20), 308 (13-21), 3008 (16-21), 508 (19-21), 5008 (14-21), PARTNER III (15-18) PARTNER IV (18-21) RIFTER (19-21) TOYOTA: AYGO (14-18) GM: CROSSLAND X (17-20), COMBO E (18-20), GRANDLAND X (17-20)
HERRAMIENTAS OEM	CITROËN: G-0109-6 (2), 0109-2B (1), 0109-2C (3), 0109-2D (4), 0197-N (1) PEUGEOT: G-0109-6 (2), 0109-2B (1), 0109-2C (1), 0109-2D (4), 0197-N (1) VAUXHALL: EN-52127-2 (1), EN-52809 (2)
CÓDIGOS DE MOTOR	1.2 VTI: 1PP(HM01), EB2 (HMZ), EB2DTS(HNY), EB2 (HMW), EB2M (HMY), EB2 (HMZ), EB-2DTS(HNY), HMP (EB2FB), HMT(EB2D), HMU(EB2D),HMV (EB2M), HMY (EB2M), HMZ (EB2), HMZ (EB2D), HMZ (EB2F),HMZ (EB2FB) 1.2 E-VTI: HMZ (EB2F), EB2F (HMZ) 1.2 PURETECH THP: HNZ (EB2DT) 1.2 PURETECH VTI: EB2ADS (HNS), EB2D(HMT), EB2ADJ (HNP),EB2ADT (HNK), EB2ADTX (HNN), EB2DTS (HNW), EB2DTM (HNV),EB2DTSM (HNW), EB2FA (HMR), EB2FAD (HMH), EB-2FAD (HMM),EB2DT (HNZ), EB2F (HMX), EB2F (HMT), EB2F(HMZ), EB2DTS(HNY),EB2M(HMY)



REF. DESCRIPCIÓN

16400 MEDIDOR DE DESGASTE DE LA CORREA DE DISTRIBUCION PSA (REF.54288)

54323

119,00€



KIT DE CALADO PARA PSA 1.0, 1.2 VTI, 1.2 GDI PURETECH

MARCAS	CITROËN: C1 II (2014-2018), C3 III (2012-2017), C3 IV (2016-2018), C4 CACTUS (2014-2020), C4 AIRCROSS (2018-2020), C-ELYSEE (2012-2018), DS3 (2012-2018), BERLINGO IV (2018-2020), GM: CROSSLAND X (2017-2020), COMBO E (2018-2020), GRANDLAND X (2017-2020) PEUGEOT: 108 (2014-2018), 208 (2012-2021), 2008 (2013-2021), 301 (2012-2020), 308 (2013-2021), 3008 (2016-2021), 508 (2019-2021), 5008 (2014-2021), PARTNER III (2015-2018), PARTNER IV (2018-2021), RIFTER (2019-2021) TOYOTA: AYGO (2014-2018).
HERRAMIENTAS OEM	EN-52127-2 (1), 0109-2B (1) J-0109-2C (2) J-0109-2D (3) EN-52127-1 (4), 0109-2A21 (4) G-0109-6 (5)
CÓDIGOS DE MOTOR	B12XHL (EB2DT), B12XHT (EB2DTS), D12XHL (EB2ADT), D12XHL (HNP/EB2ADT), D12X-HT (EB2ADTS), EBO (ZMZ), EBOF (ZMZ), EB2ADT (HNK), EB2ADT (HNP), EB2ADTD (HNK), EB2ADTS (HNS), EB2ADTX (HNN), EB2DT (HNZ), EB2DTM (HNV), EB2DTS (HNW), EB2DTS (HNY), EB2DTSM (HNW), EB2FA, EB2FAD, F12XHT (EB2ADTS), F12XHT (HNS/EB2ADTS), HMM (EB2FAD), HMM (EB2FAD), HMP (EB2FB), HMR (EB2FA), HMT (EB2), HMT (EB2F), HMU (EB2D), HMU (EB2FD), HMV (EB2M), HMW (EB2), HMX (EB2F), HMY (EB2M), HMZ (EB2), HMZ (EB2F), HNJ (EB2ADTXM), HNK (EB2ADT), HNK (EB2ADTD), HNK/EB2ADTD, HNL (EB2ADTSM), HNN (EB2ADTX), HNP (EB2ADT), HNS (EB2ADTS), HNS/EB2ADTS, HNT (EB2ADTS), HNV (EB2DT), HNV (EB2DTM), HNW (EB2DTS), HNW (EB2DTSM), HNX (EB2DT), HNX (EB2DTS), HNY (EB2DTS), HNZ (EB2DT), HN02, ZMZ (EBO), ZMZ (EBOF), 1PP (HM01)

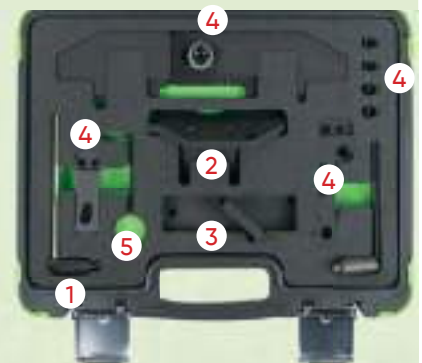

KITS DE CALADO (TIMING TOOLS)

54213

19,80€

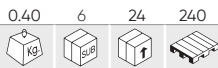

KIT DE CALADO PARA ROVER/PEUGEOT/FORD/VOLVO 2.0, 2.2L D

MARCAS	PEUGEOT: 807 (05-11), 407 (05-11), 607 (05-09).CITROËN: C4 (04-10), C5 II (04-10). LAND ROVER: FREELANDER (06-10). VOLVO: S40 (03-10), V50 (06-10), C70 (06-10), S80 (07-10), C30 906-10), V70 (07-10).FORD: S MAX 2.2 (08-10), GALAXY 2.2 (08-10), MONDEO 2.2, 2.0 (07-10).
HERRAMIENTAS OEM	PSA 0188.M, FORD 303-735, 303-1277, VOLVO 999-7122 (1) PSA 0188.X, FORD 303-1059, 303-1270, VOLVO 999-7121 (2) PSA 0188.F, FORD 303-393A, 303-393-01, 303-1272, VOLVO 999-7119/7120 (3)
CÓDIGOS DE MOTOR	PEUGEOT: DW10UTED4 (RHK), DW10BTED4 (RHR)DW12B-TED4 (4HS), (4HP), (4HT), (4HR). CITROËN: DW10BTED4 (RHR). LAND ROVER:DW12BTED4, 224DT. VOLVO:D420T 2.0D. FORD: QXBA(2.2), QXWA(2.0), QXBB(2.0),Q4BA(2.2), QXWA(2.0), QXWB(2.0), AZBA(2.0), AZBC(2.0), AZWA(2.0)

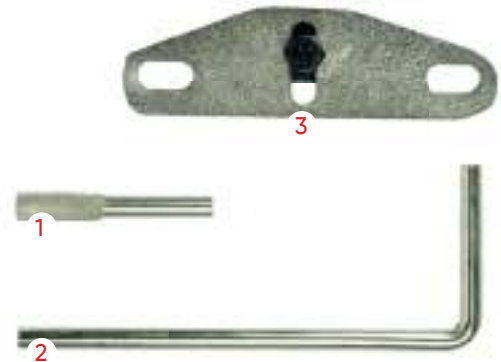

54432

43,00€



KIT DE CALADO PSA 2.7, 3.0 HDI

MARCAS	CITROËN C6 JAGUAR S-TYPE (X200) 2004 - 2008, XF S (X250) 2008 - 2015, XF S (X260) 2015 - 2020, XJ6 TDV1 (X350/358) 2005 - 2010, XJ (X351) 2010 - 2020, F-PACE S 30D (X761) 2016 - 2020 LAND ROVER: DISCOVERY 3 TDV6 (L319) 2004 - 2009, DISCOVERY 4/DISCOVERY SDV6, TDV6 (L319) 2009 - 2017, DISCOVERY SD6, TD6 (L462) 2017 - 2021, RANGE ROVER SDV6, SDV6 HYBRID, TDV6 (L405) 2012 - 2021, RANGE ROVER SPORT SDV6, TDV6 (L320) 2005 - 2013 PEUGEOT 407, 607 COUPE RANGE ROVER VELAR D275, D300 (L560) 2017 - 2021, RANGE ROVER SPORT SDV6, SDV6 HYBRID, TDV6 (L494) 2013 - 2021
HERRAMIENTAS OEM	303 11117 (1), 303 11116 (2), 303 1132 (3), 303 1126 (4), 0195H (4), 0195C (5), 0195K (6), 0188-K (7)
CÓDIGOS DE MOTOR	2.7: DT17 TED4 (UHZ), DT17BTED4 (UHZ) 3.0: DT20C (X8C/X8Z), DT20CTED4 (X8Z)



54433

18,00€



KIT DE CALADO PSA 1.0, 1.1, 1.2, 1.4, 1.6, 2.0

MARCAS	CITROËN BERLINGO 2008 - 2011, C2 2003 - 2010, C-ELYSEE 2012 - 2016, C3 PLURIEL 2003 - 2010, C4 2004 - 2011, NEMO 2008 - 2015, XSARA 2000 - 2005 PEUGEOT 106 1998 - 2003, 206 1998 - 2009, 207 2006 - 2013, 306 1998 - 2003, 307 2000 - 2008, 1007 2005 - 2010, PARTNER 1998 - 2011, BIPPER 2008 - 2015
HERRAMIENTAS OEM	0132QY (1), 4507 TA (1), 0132AK (2), 0153AK (2), 0188K (2), 0189K (2), 1870 900 100 (2), 4533 TAD (2), MOT 1436 (2) 3MM PIN (3), 0132AB (4), 0178D (4), 0194A (4), 77440010400 (4), 1860.617000 (4), 11 9 790 (4), 21-260 (4), 303-732 (4), 4527 TS2 (4), 49 JEO2 018 (4), 5711 TD (4), 99360608 (4), 999 7169 (4), KM-6349 (4), 0132AJ1 (5), 0187B (5), 0189B (5), 0194B (5), 09919 58120 (5), 21 263 (5), 303 735 (5), 3031277 (5), 49 JEO2 021 (5), 607589011500 (5), 8MM DRILL BIT (5), 8MM PIN (5), 999 7122 (5), EN-52137 (5), MOT. 1430 (5), MOT 1430 (5), 0123-RZ (6), 0132R (6), 0153AA (6), 0153AB (6), 0153G (6), 0153Z (6), 10MM PIN (6), 4507 TB (6), 7014 TN, 9767 27 (6), M10 X 70MM (6), 0132Q (7), 0132QZ (7), 132Z (7), 4507 TA (7)
CÓDIGOS DE MOTOR	1.0: TU9 (C1A), TU9/K (C1A), TU9M (CDY/CDZ), TU9MZ (CDY/CDZ), TU9M/L (CDZ), TU9M/L3 (CDY) 1.1: TU1A (HFV/HFX), TU1JP (HFX/HFY/HFZ), TU1JP/L4 (HFX), TU1/K (H1A), TU1M (HDZ), TU1M/L (HDZ), TU1M/L3 (HDY/HDZ), TU1M/Z (HDZ), TU1M+ (HDY/HDZ) 1.4: ET3J4 (KFU), ET3JP4 (KFU), TU3A (KFT/KFV/KFW), TU3FJ2 (K6B/KFZ), TU3FM (KDY), TU3JP (KFW/KFX/KFY), TU3JP/IFL4 (KFX)TU3JP/L3 (KFX), TU3JP/L4 (KFX), TU3JP/IFL4 (KFX), ET3J4 (KFU), TU3M (KDX), TU3M/Z (KDY) 1.6: EC5 (NFP), EC5F (NFP), TU5J2 (NFY/NFW), TU5J4 (NFU), TU5JP (NFT/NFZ), TU5JP/L3 (NFZ), TU5JP/L4 (NFT/NFV), TU5JP4 (NFU), TU5JP4B (NFR), TU5JP4S (NFS), TU5JP4/L3 (NFX), TU5JP4/L4 (NFU/NFX), XU5JP (BFZ) 1.8: XU7JB (LFX), XU7JP (LFW), XU7JP/L3 (LFZ), XU7JP4 (LFY), XU7JP4/L3 (LFY) 2.0: XU10J/C/Z (RFU), (RGX), XU10J2E/V (RGX), XU10J2U (RFL), XU10J4R (RFR/RFV), XU10J4R/L3 (RFV), XU10J4RS/L3 (RFS)

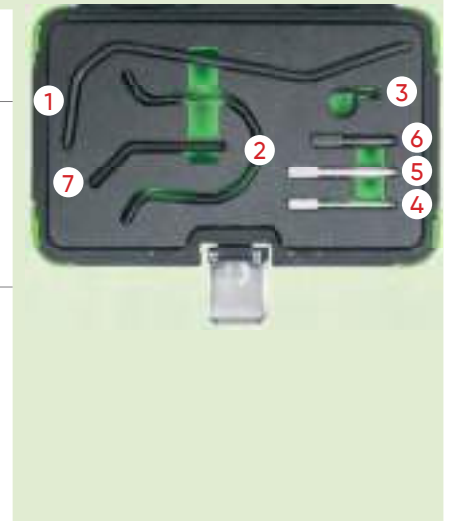

53293

134,00€

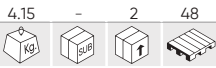

KIT DE CALADO FORD

MARCAS	B-MAX (12-17), C-MAX (07-17), COUGAR (98-01), COURIER (00-02), ESCORT (94-98), FIESTA (95-17), FOCUS (98-17), FOCUS C-MAX (03-07), FUSION (02-12), GALAXY (06-15), GRAND C-MAX (10-17), KUGA (08-15), MAVERICK (01-07), MONDEO (93-15), ORION (94-94), PUMA (97-02), S-MAX (06-15), TOURNEO CONNECT (02-15), TRANSIT (06-11), TRANSIT CONNECT (02-16), ECOSPORT (13-15), TOURNEO COURIER (14-15), GRAND TOURNEO COURIER (13-15).
HERRAMIENTAS OEM	303-376 (21-162B) (1), 303-1059 (2), 303-193 (21-104) (3), 303-393-01 (4), 303-1054 (5), 303-1097 (6), 303-748 (7), 303-734 (21-262) (8), 303-651 (21-229) (9), 303-393A (21-168) / 303-393-02 / 303-507 (21-210) / 303-620 (21-163) / 303-732 (21-260) / 303-735 (21-263).
CÓDIGOS DE MOTOR	PETROL: AODA/B, ASDA, ASDB, CFBA, CGBA/B, CHBA/B, CJBA/B, CSDA/B, DHA, DHB, DHC, DHD, DHE, DHF, DHG, EDBB, EDBD, EDDB, EDDC, EDDF, EYDB, EYDC, EYDD, EYDE, EYDF, EYDG, EYDI, EYDJ, EYPA, EYPC, F8JA, F8JB, FHA, FHD, FHE, FHF, FUJA, FUJB, FXDA/C, FXDB/D, FXJA, FXJB, FYDA/C, FYDB/D, FYJA, FYJB, HWDA, HWDB, L1F, L1J, L1L, L1N, L1Q, L1T, L1V, L1W, M7JA, M7JB, MHA, MHB, NGA, NGB, NGC, NGD, QQDA/B/C, QQDB, RKA, RKB, RKF, RKH, RKJ, RKK, HXDA. GASOIL: F6JA, F6JB, F6JC, HHJA, HHJB, G8DA, HHDA, HHDB, RTN, RTQ, RTP, C9DC, BHDA/B, BHPA, C9DA/B, F9DA/B, FFBA, FFDA, HCPA, HCPB, KKDA, P7PA, P9PA, QYWA, R2PA, R3PA, RWPA, G6DA, G6DB, G6DC, AZWA, QXWA.

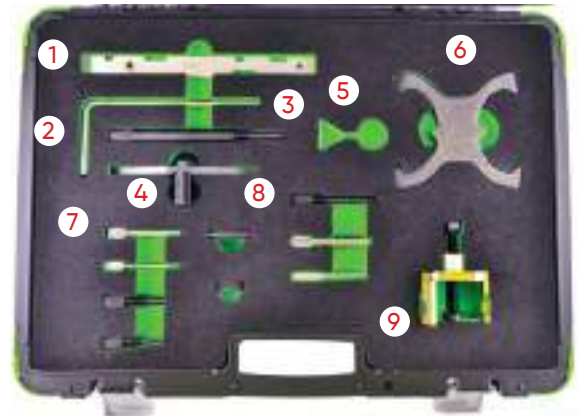

53294

119,00€

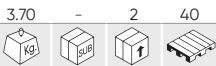

KIT DE CALADO FORD MAZDA

MARCAS	FORD: COURIER (00-02), C-MAX (03-10), FIESTA (02-11), FOCUS (98-11), FUSION (02-11), GALAXY (06-10), KUGA (06-10), MONDEO (07-10), S-MAX (06-10), TOURNEO CONNECT (02-13), TRANSIT CONNECT (02-13) PEUGEOT: BIPPER (08-10) DISPATCH/JUMPY III (07-12) EXPERT III (07-12) NEMO (08-10) PARTNER I/II (05-11) PARTNER III (08-16) 107 (05-10) 1007 (05-10) 206 (01-12) 206+ (09-13) 206 CC (05-07) 207 (06-13) 207 CC (07-15) 208 (11-15) 307 (01-08) 308 (07-15) 308 CC (09-15) 407 (05-11) 508 (04-15) 2008 (13-15) 3008 (09-15) 4008 (12-15) 5008 (09-15). MAZDA: 2 (02-15), 3 (09-14) CITROËN: C1 (05-10), C2 (03-10), C3 I/II (02-10), C3 III (10-15), C3 PLURIEL (04-10), C3 PICASSO (09-12), C4 (04-11), C4 II (11-15), C4 PICASSO (06-12), C4 GRAND PICASSO (10-12), DS3 (09-12), DS4 (11-12), DS5 (12-15), C5 II (04-08), C5 III (04-12), XSARA II (02-04), XSARA PICASSO (04-10)
HERRAMIENTAS OEM	FORD: 303-376B (1), 303-193 (2), 303-393 (3), 303-732 (4), 303-651 (5), 303-393/01, 303-1059, 303-734, 303-735, MAZDA: 303-732, 303-734, 303-735. PSA: 0194-A, 0194-C, 0194B.
CÓDIGOS DE MOTOR	1.4D TDCi/Hdi: DV4TD(8HT), DV4TD(8HX), DV4TD(8HZ), DV4TD(8HW), DV4TED4(8HX), DV4TED4(8HV), DV4TED4(8HY), DV4C(8HP), DV4C(8HR), DV4TED(8HS), F6JA, F6JB, F6JC. 1.6D TDCi/HDi: DV6TED4(9HZ), DV6ATED4(9HX), DV6TED4(9HY), DV6DTE4(9HP), DV6C(9HR), DV6CATED(9HX), DV6C(9HL), DV6TED(9HP), DV6ATED(9HY), DV6TED4(9HV), DV6TED4(9HX), DV6C(9HD), DV6C(BHX), DV6C(BHZ), DV6(9HR), DV6BTED4(9HW), DV6DTE4(9HJ), DV6ETED(9HN), DV6ATED4BU(9HS), DV6BTED4(9HT), DV6BUTED4(9HT), DV6TED4B(9HV), DV6UTED4(9HX), DV6TED(9HD), DV6UTED4(9HU), DV6D(9HP), DV6TED4(9HV), DV6C(9HD), DV6TED4(9HW), DV6AT(9HX), DV6ATED(9HX), DV6CTED(9HC), DV6AUTED4(9HX), DV6TED4B, DV6DTE4(9HF), HHJA, HHJB, G8DA, G8DB, HHDA, HHDB, MZ-CD, Y6. 1.8D TDCi/HDi: BHPA, C9DA/B, FFBA, G6DA, G6DB, G6DC, HCPA, HCPB, KKDA, P7PA, P9PA, R2PA, R3PA, RWPA. 1.8d: C9DC, RTN, RTQ. 1.8D Td: C9DA/B, C9DC. 2.0D TDCi/HDi: AZWA, G6DA, G6DB, G6DC, RHE(DW10CTED4), QXWA, QXWB.

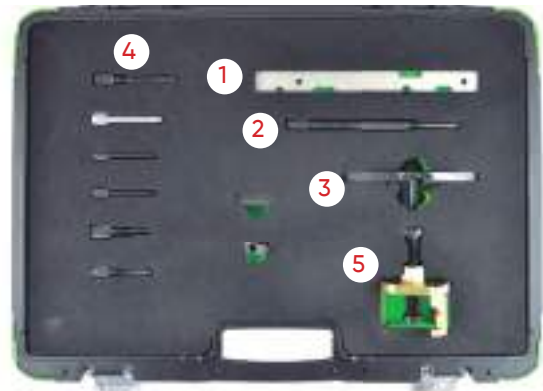

53318

24,00€



EXTRACTOR DE POLEA DE ÁRBOL DE LEVAS FORD

MARCAS	FORD
HERRAMIENTAS OEM	F8M, F8Q, S8U, S9U.



53295

77,00€

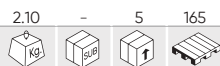

KIT DE CALADO FORD 1,8TDDI, TDCI

MARCAS	C-MAX (07-10), COURIER (00-02), FIESTA (00-02), FOCUS (98-11), FOCUS C-MAX (03-07), GALAXY (06-10), MONDEO (07-10), S-MAX (06-14), TOURNEO CONNECT (02-13), TRANSIT CONNECT (02-13).
HERRAMIENTAS OEM	303-193 (21-104) (1), 303-393 (21-168) (2), 303-376 (21-162B) (3), 303-652 (21-230) (4), 310-095 (23-067) (5)
CÓDIGOS DE MOTOR	1.8D TDCI: BHPA, F9DA, F9DB, FFBA, FFDA, FFWA, HCPA, HCPB, KHBA, KKDA, KKDB, P7PA, P9PA, P9PB, QYBA, QYWA, R2PA, R3PA, RWPA, RWPC. 1.8D TDCI ECONETIC: KHBA. 1.8D TDI: BHDA, BHDB, BHPA, C9DA, C9DB, C9DC. 1.8D TURBO: C9DC, RTN, RTP, RTQ.

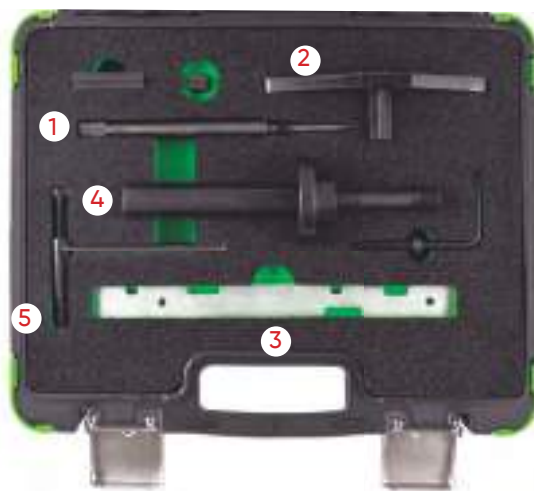

53296

60,00€

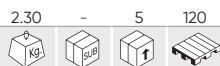

KIT DE CALADO PARA BOMBA DE INYECCIÓN FORD/JAGUAR DURATORQ

MARCAS	FORD: MONDEO (00-07), TRANSIT (00-14). CITROËN: RELAY, JUMPER III (06-13). FIAT: DUCATO (06-11).	JAGUAR: X-TYPE (03-10). PEUGEOT: BOXER III (06-12). LAND ROVER: DEFENDER TD4 (06-11). LDV: CONVOY (02-06).
HERRAMIENTAS OEM	303-1151 (1), 303-679A/21-238 (2), 303-732 (3), 303-675/21-234 (4), 303-698/21-251 (5)	
CÓDIGOS DE MOTOR	1.2D DI/TDDI/TDCI: ABFA, D3FA, F3FA, D5BA, D6BA, F1FA, FMBA, FMBB, HJBA, HJBB, HJBC, HJBE, N7BA, N7BB. 2.2D TDCI/ECONETIC: BG, CYFA, CYFB, CYFC, DRFA, DRFB, DRFC, P8FA, P8FB, PGFA, PGFB, QJBA, QJBA (BG), QJBB, QJBC, QJBD, QVFA, QWFA, SRFA, SRFB, SRFC, SRFD, SRFE, UHFA. 2.2D HDI/JTD: P22DTE (4HM), P22DTE (4HU), P22DTE (4HV). 2.4D DI/TDCI: DOFA, D2FA, D2FB, D4FA, F4FA, FXFA, H9FA, H9FB, H9FD, JXFA, JXFC, PHFA, PHFC. 2.4D TD/TDI: ZSD 424. 2.4D TD4: 244DT.	



54419

57,00€

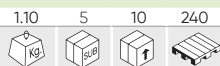

EXTRACTOR/INSTALADOR DE RETEN DELANTERO DE CIGÜEÑAL FORD DURATORQ 2.0, 2.2, 2.4, 3.2

MARCAS	FORD MONDEO 2000 - 2007 RANGER 2011 - ON TRANSIT 2000 - 2006 TRANSIT 2006 - 2014 TRANSIT 2014 - 2019 TRANSIT/TOURNEO CUSTOM 2012 - 2016
HERRAMIENTAS OEM	21 238 (1), 303-679A (1), 303-682 (2)
CÓDIGOS DE MOTOR	2.0 Di ABFA D3FA F3FA 2.0 TDCI FMBA FMBB HJBA HJBB HJBC N7BA N7BB SDBA F1FA 2.0 TDDi D5BA D6BA 2.2 TDCI QJBA QJBB QJBC QJBD GBVAJQJ GBVAJQJ GBVAJQV JQW CVRA CVRB CYFA CYFB CYFC CYRA CYRB DRFA DRFB DRFC DRFE DRRB DRRB P8FA P8FB PGFA PGFB QVFA QWFA SRFA SRFB SRFC SRFD SRFE UHFA UHFB 2.4 Di D2FA D2FB D4FA DOFA F4FA FXFA 2.4 TDCi H9FA H9FB H9FD JXFA JXFC 3.2 TDCi SAFA SA2R SA2S SA2W SAFA SAFB



54420

102,00€



N

CONJUNTO DE REGLAJE GASOLINA – FORD / VOLVO 2.5 (EURO 4)

MARCAS	FORD: FOCUS 2.5 RS / ST, MONDEO 2.5, S-MAX 2.5, GALAXY 2.5 ST (2005-) VOLVO: C30 (06-10), C70 (98-10), S40 (96-10), S60 (00-09), S70 (97-07), S80 (98-06), V40 (96-10), V50 (04-10), V70 (97-07), XC70 (02-07), XC90 (02-10)
HERRAMIENTAS OEM	303-1178 (1), 999 5452 (1), MOT 1337 (1) 303-1182 (2), 999 5451 (2), MOT 1340 (2) 303-1179 (3), 999 5433 (3) 303-1183 (4)
CÓDIGOS DE MOTOR	FORD: 2.5 Turbo (Euro 4), HUBA / HUWA / HYDA / JZDA VOLVO: 1.6 (B4164S), 1.8 (B4184S), 1.9T (B4194T), 2.0 (B4204S / B4204T), 2.0T (B5204T3 / B5204T4 / B5204T5), 2.3 (B5234FS), 2.3T (B5234T3 / B5234T7 / B5234T9) VOLVO: 2.4 (B5244S / B5244S2 / B5244S4 / B5244S5 / B5244S7), 2.4T (B5244T / B5244T3 / B5244T4 / B5244T5 / B5244T7), 2.5R (B5254FS), 2.4D (D5244T9 / D5244T8 / D5244T13)

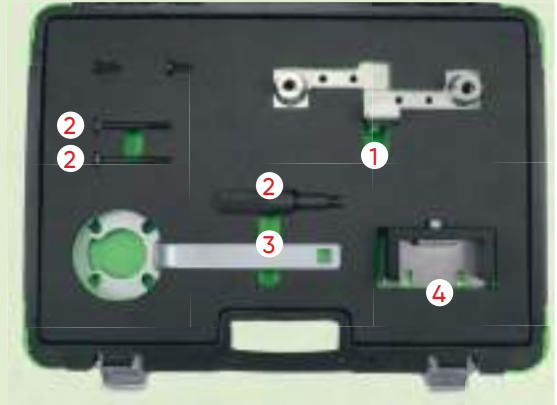

54421

52,00€



N

INSTALADOR DE CORREAS AUXILIARES FORD/VOLVO 1.4 1.6

MARCAS	FORD 1.4, 1.6 (FOCUS, C-MAX, MONDEO) VOLVO 1.6 (S40, C30, V50)
HERRAMIENTAS OEM	303-1179
CÓDIGOS DE MOTOR	B4164S3, FUJA, FXJA, FYJA C12HM7AD, C12LM7AA, ZH12FUJA, ZH12FUJB, ZH12M7JB C14HDEZ, C14HHADB, ZH14ASDA, ZH14FXDA, ZH14FXDB, ZH14FXDC, ZH14FXDD, ZH14FXJA, ZH14FXJB 16HDEZ, CH16HDEZ, C16HHDEY, ZH16FYDA, ZH16FYDB, ZH16FYDC, ZH16FYDD, ZH16FYDH, ZH16FYJA, ZH16FYJB, ZH16HWDA, ZH16HXDA



54424

64,50€



N

KIT DE CALADO FORD 2.0 ECOBOOST

MARCAS	FOCUS, GALAXY, MONDEO, S-MAX
HERRAMIENTAS OEM	303-1504 (1) 303-1600 (2), 300-1565 (2) 303-1521 (3) 303-748 (4) 303-1595 (5) 2MM TENSIONER (6)
CÓDIGOS DE MOTOR	MGDA, R9CB, R9CD, R9CF, R9CH, R9DA, R9DB, R9DC, R9DD, TNBA, TNBB, TNCC, TNCD, TNCF, TNWA, TNWB, TPBA, TPWA, TVDA, XQDA

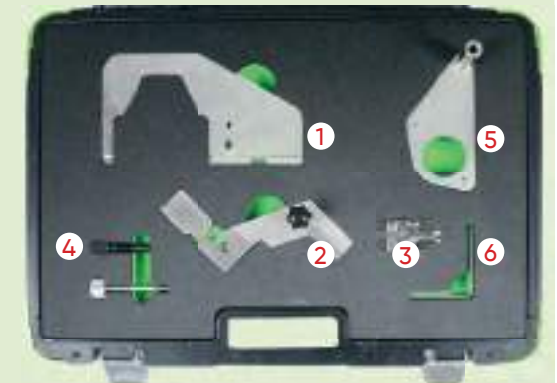

KITS DE CALADO (TIMING TOOLS)

53324

12,50€

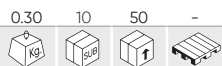

KIT DE CALADO FORD

MARCAS	FORD: B-MAX (15-17), C-MAX (07-10), COUGAR (98-01), FIESTA (95-17), FOCUS (98-11), FOCUS C-MAX (03-07), FUSION (02-12), GALAXY (06-15), MAVERICK (01-07), MONDEO (93-15), PUMA (97-02), S-MAX (06-15), TOURNEO CONNECT (02-06), TRANSIT (06-12), TRANSIT CONNECT (02-06). MAZDA: 121 ZG (95-00), 2 DY (02-07), 3 BK (03-09), 3 BL (09-15), 5 CR (05-10), 5 CW (10-12), 6 GG/GY (02-07), 6 GH (07-15), MPV LW (02-05), MX-5 NC (05-16), TRIBUTE EP (04-06). VOLVO: C30 (06-13), S40 (06-12), S80 (07-11), V50 (04-12).
HERRAMIENTAS OEM	FORD: 303-1054, 303-507 (21-210), 303-620 (21-163), 303-574, 303-748, 303-376 (21-162B), 303-376B MAZDA: 49 JE01 061, 303-574, 49 JE02 061, 303-465, 49 JE01 054 VOLVO: 999 7152, 999 7151.
CÓDIGOS DE MOTOR	1.4 / 1.6



53653

207,00€



KIT DE CALADO FORD

MARCAS	FORD: FIESTA, FOCUS, B-MAX, ECOSPORT.
HERRAMIENTAS OEM	303-1605 (1), 303-1606 (2), 303-1604 (3), 303-1602 / 503-393A / (21-168) (4), 303-1054 (5), 303-732 (6)
CÓDIGOS DE MOTOR	M1DD, M1JA, M1JC, M1JE, M1JHM1JJ, M1DA, M2DA, M2DB, M2DC, SFDBSFJA, SFJB, SFJC, SFJD

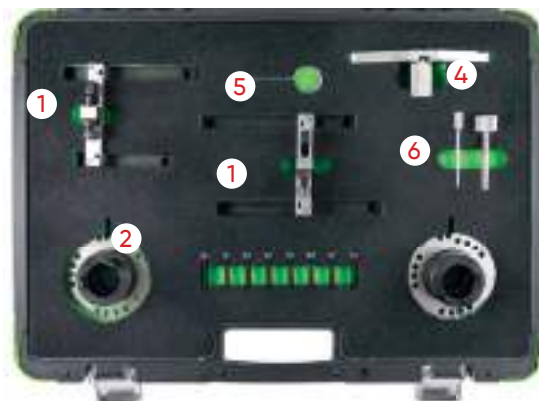

54201

37,60€



KIT DE CALADO FORD

MARCAS	FORD: C-MAX(07 - 10), C-MAX/GRAND C-MAX(10-18), FIESTA(08-18), FOCUS/FOCUS C-MAX(04-11), FOCUS(11-18), MONDEO(07-15)
HERRAMIENTAS OEM	303-1097 (1), OEM 303-1054 (2), OEM 303-1059, 303-1270, 0188X, 999-7121 (3), OEM 303-748, 999-7152, 21-259 (4), OEM 303-735, 999 7122, 0187B, 0189B, 0132AJ1, 21-263, 0188M, MOT 1430, 303-1277, 0194B (5)
CÓDIGOS DE MOTOR	11.6 TI-VCT HXDA (2003-2007) ,2.0 TDCI , G6DA, G6DB, G6DC 2003-2007



54204

124,00€

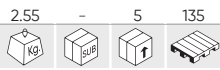

KIT DE CALADO PARA FORD 2.0 ECOBLUE

MARCAS	FORD EDGE, FOCUS, GALAXY, S-MAX (FROM 2018); KUGA, MONDEO, RANGER (DESDE 2019); TRANSIT, TRANSIT CUSTOM AND TOURNEO CUSTOM (DESDE 2016); TODOS CON MOTOR ECOBLUE TDCI ; AWD, FWD Y RWD.
HERRAMIENTAS OEM	303-1637 (1), 303-1650 (2), 303-1643 (3).
CÓDIGOS DE MOTOR	BCCC,YLCB,YLDA,YLF6,YLFA,YLFB,YLFS,YLR6,YLRA,YMCB,YM-F6,YMFA,YMFB,YMFS,YMHA,YMRA,YNCA,YNF6,YNFA,YNFB,YNFS,Y-NR6,YNRA

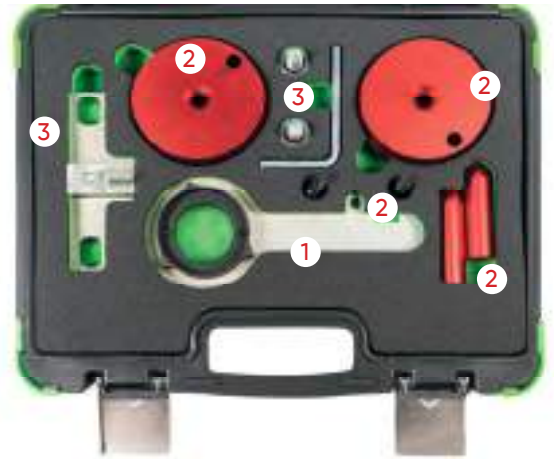

54208

76,00€

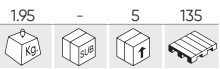

KIT DE CALADO PARA FORD 2.0 ECO BOOST SCTI, TI-VCT

MARCAS	FORD: GALAXY(2010)MONDEO (2010) S MAX (2010) FOCUS(2011)
HERRAMIENTAS OEM	303-748 (1), 303-1504 (2), 303-1565 (3), 303-1521 (4)
CÓDIGOS DE MOTOR	TNWA, TNWB, TPWA, TNBA, TPBA, MGDA, XQDA

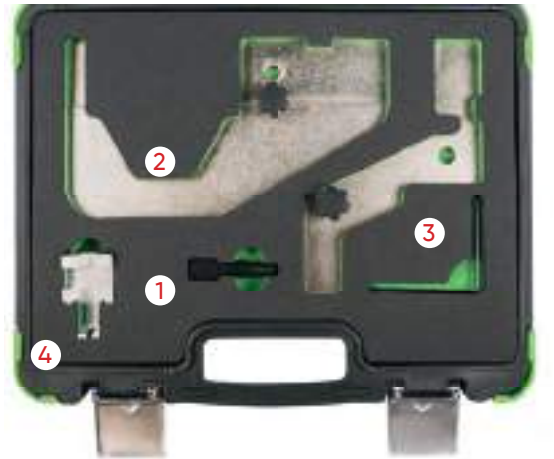

54209

29,70€

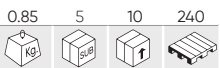

KIT DE CALADO PARA FORD/MAZDA 2.2, 3.2 TDCI

MARCAS	FORD_RANGER 3.2L (2011-2016) FORD_RANGER 2.2L (2011-2015) FORD_TRANSIT 2.2L (2006-2016) FORD_EVEREST 3.2L (2015) FORD_RANGER 3.2L (2011) MAZDA BT-50 (2011) MAZDA BT-50 3.2L (2011-2016)
HERRAMIENTAS OEM	303-675/21-234,303-698/21-251 (1), 303-1587 (2)
CÓDIGOS DE MOTOR	CYFA,CYFB,DRFA,DRFB,P8FA,P8FB,PGFA,PGFB,QVFA,QWFA,SR-FA,SRFB,SRFC,SRFD,SEFE,UHFA,CYFC,DRFC,USRA



KITS DE CALADO (TIMING TOOLS)

54223

149,00€



HERRAMIENTA DE BLOQUEO DE ÁRBOL DE LEVAS PARA FORD 1.5T

MARCAS	FORD_1,5L DURATEC, ECOSPORT, FIESTA, FOCUS
HERRAMIENTAS OEM	303-1639 (1), 303-1643 (2), 303-1647 (3), 303-1648 (4)
CÓDIGOS DE MOTOR	2.2 / 2.5

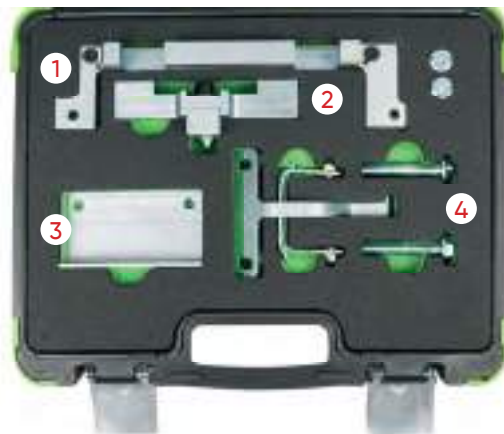

54224

64,50€



KIT DE EXTRACCIÓN E INSTALACIÓN DE BOMBA DE INYECCIÓN PARA FORD 2.0

MARCAS	FORD: TRANSIT (17-18), TOURNEO CUSTOM (16-18), TRANSIT CUSTOM (16-18)
HERRAMIENTAS OEM	303-1635 (1)/3, 3.3--1635 (2)/1, 303-1635 (3)/2, 303-1635/6 (4)
CÓDIGOS DE MOTOR	YLFS, YMFS, YNFS, YLF6, YMF6, YNF6, YLR6, YMR6 AND YNRS.

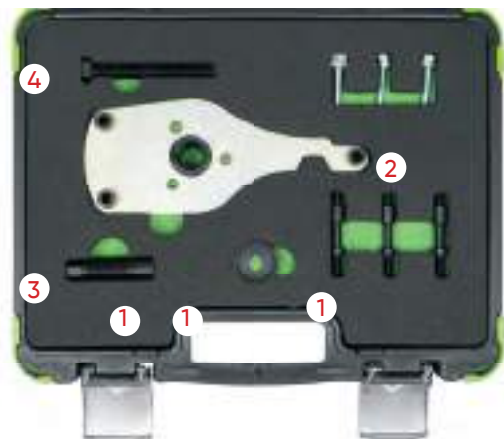

54260

277,00€

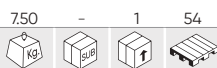

MULTIPLICADOR DE FUERZA 5:1 PARA MOTORES FORD ECOBOOST



1.0 EcoBoost
1.0 Duratec
2.0 Duratec

2.0 Durator-TDCi
2.0 EcoBlue Diesel

53297

45,00€

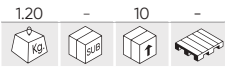

KIT DE CALADO JAGUAR/LAND ROVER

MARCAS	JAGUAR: MS TYPETDVI. LAND ROVER: DISCOVERY 2.7 TDV6. RANGE ROVER: SPORT 2.7 TDV6.
HERRAMIENTAS OEM	303-1117 (1), 303-1116 (2), 303-1132 (3), 303-1126 (4) (5)
CÓDIGOS DE MOTOR	276DT, 306DT.

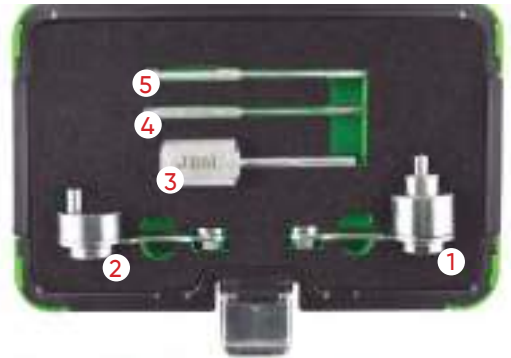

53298

91,00€

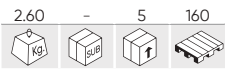

KIT DE CALADO LAND ROVER

MARCAS	MOTORES DIESEL: 200 TDI. 300 TDI. 2.5
<ul style="list-style-type: none"> - Pasador de sincronización de transmisión manual EDC. - 200 TDI. 300 TDI. 2.5 Motores diésel. - Extractor de amortiguador del cigüeñal. - Herramienta de bloqueo de la bomba de inyección. - Perno de sincronización de la bomba de inyección 200/300 TDI. - Herramienta de sincronización del volante de motor 200/300 TDI. - Herramienta de sincronización de bomba DPS 2.5. - Herramienta de sincronización del volante de motor 2.5. 	



54422

140,00€



KIT PARA REGLAJE DE EJES DE EQUILIBRIO JAGUAR/LAND ROVER 2.0D

MARCAS	JAGUAR: E-PACE D150, D180, D240 (X540) (2017-), F-PACE 20D, 25D, E-PERFORMANCE (X761) (2016-), XE 20D, 25D, E-PERFORMANCE (X760) (2015-), XF 20D, 25D, E-PERFORMANCE (X260) (2015-) LAND ROVER: DEFENDER SD4 D200, SD4 D240 (L663) (2019-2021), DISCOVERY SPORT ED4, SD4, TD4, D150, D180, D240 MHEV (L550) (2015-), DISCOVERY SD4, TD4 (L462) (2017-2021) RANGE ROVER: EVOQUE ED4, SD4, TD4 (L538) (2015-2019), EVOQUE D150, D180, D240 MHEV (L551) (2019-), SPORT SD4 (L494) (2016-2018), VELAR D180, D240 (L560) (2017-)
HERRAMIENTAS OEM	JLR-303-1662 (1) JLR303-1663-1 (2) JLR303-1663-2 (3) JLR303-1663-3 (4) JLR-303-1664 (5) JLR-303-1665 (6)
CÓDIGOS DE MOTOR	2.0: AJ200D,AJ200/204DTA,AJ200/2004DTD 2.0: AJ-200D/204DT, AJ-200D/204DTA



KITS DE CALADO (TIMING TOOLS)

54423

108,00€



N

KIT DE CALADO LAND ROVER 3.6D

MARCAS	RANGE ROVER SPORT; 3.6 (TDV8) DIESEL (2006-2011) RANGE ROVER; 3.6 (TDV8) DIESEL (2006-2011)
HERRAMIENTAS OEM	303-1236 (1) 303-1243 (2) 303-1239 (3) 303-1238 (4)
CÓDIGOS DE MOTOR	368DT



54425

124,00€



N

KIT DE CALADO LAND ROVER FREELANDER V6/ROVER KV6 2.0L, 2.5L

MARCAS	LAND ROVER; FREELANDER (2000-2006) MG; ZR (2004-2005), ZS (2001-2005), ZT (2001-2005) ROVER; 45 (1999-2005), 75 (1999-2005), 825 (1996-1999)
HERRAMIENTAS OEM	LRT 12-175 (1) LRT 12-187 (2) LRT 12-195 (3) LRT 12-196 (4) LRT 12-198 (5) LRT 12-232 (6)
CÓDIGOS DE MOTOR	LAND ROVER; 2,5 KV6 MG; 2,0 KV6, 2,5 KV6 ROVER; 2,0 KV6 2,5 KV6



54426

69,00€



N

KIT DE CALADO JAGUAR/LAND ROVER 3.2, 3.5, 4.0, 4.2, 4.4

MARCAS	DAIMLER; V8 (97-03), SUPER V8 (97-03), SUPER EIGHT (05-10). JAGUAR; S-TYPE (99-08), XF (08-09), XJR (97-10), XJ8 (97-10), XKR (98-09), XK8 (96-09) LAND ROVER; DISCOVERY III (04-09) RANGE ROVER (05-09), RANGE ROVER SPORT (05-09)
HERRAMIENTAS OEM	303530 (1) 303531 (2) 303532 (3) 303533 (4) 303645 (5) 303654 (6) T40011 (7)
CÓDIGOS DE MOTOR	3.2: AC,KB,KC 3.5: RB 4.0: BC, CC,CE,DC,EC,GB,GC,LB,LC,MA,MB,NB,NC,PA,PB 4.2: 1B,2B,3B,1G,5G,9G,HB,HG,SB,TB,PC,428PS 4.4: 448PN



54427

113,00€



N

LLAVE PARA BLOQUEO DE LA POLEA DEL CIGÜEÑAL JAGUAR/LAND ROVER 4.0, 4.2, 4.4

MARCAS	DAIMLER: V8; 4.0 (97-98) JAGUAR: S-TYPE; 3.2, 3.5, 4.2 V8 (99-08), XF; 3.2, 3.5, 4.2 V8 (08-09), XJ; 3.2, 3.5, 4.2 V8 (97-08), XJ8; 4.0 (97-98), XK; 3.2, 3.5, 4.2 V8 (97-08), XK8; 4.0 (97-98) LAND ROVER: DISCOVERY3; 4.2, 4.4 LA V8 (05-09) RANGE ROVER; 4.2, 4.4 SPORT LS V8 (05-09), RANGE ROVER; 4.2, 4.4 LM V8 (06-08)
HERRAMIENTAS OEM	LRT 12 080 18G 1437 18G 1437 2 303 191 303 191 03 303 191 04 303 588 303 893
CÓDIGOS DE MOTOR	AJ26, AJ27, AJ28, AJ34 30G,36D,42D,56D,58D,94D,428PS,448PN



54428

31,00€

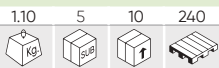

N

KIT DE CALADO CHRYSLER/ JEEP 2.8 CRD

MARCAS	CHRYSLER GRAND VOYAGER 2008 - 2015 DODGE NITRO 2007 - 2011 JEEP CHEROKEE 2008 - 2013, WRANGLER 2007 - 2018
HERRAMIENTAS OEM	VM 9991 (1) VM 9992 (2)
CÓDIGOS DE MOTOR	VM64C, ENS, ENS (51C), 49C, 50C, ENS VM10D, ENS VM11D



54429

55,00€



N

KIT DE CALADO CHRYSLER/ JEEP 3.0D

MARCAS	CHRYSLER 300 C 2012 - 2015 JEEP GRAND CHEROKEE 2011 - ON
HERRAMIENTAS OEM	VM 10338 1 (1) VM 10338 2 (2) VM 10359A (3), VM 10359 (3) VM 10339 (4), VM 10359 (4)
CÓDIGOS DE MOTOR	3.0 CRD: EXF 3.0 CRD/MULTIJET: EXF VM23D, EXF VM44D, EXF VM44D, EXF VM63D



KITS DE CALADO (TIMING TOOLS)

54207

38,90€

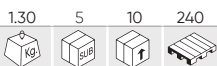

KIT DE CALADO PARA CHRYSLER/ JEEP LDV 2.5 CRD

MARCAS	CHRYSLER: VOYAGER (01-08), GRAND VOYAGER (01-08) JEEP: CHEROKEE (01-08) LDV: MAXUS (05-09)	
HERRAMIENTAS OEM	VM 9660 (1), VM1052 (2), VM1053 (3), VM1068 / VM1089 (4), VM1080 (5), VM8873 (6)	
CÓDIGOS DE MOTOR	2.5D CRD: R2516C, R2516K, R2516LVM39/40B.	2.8D CRD: R2816C5.05A, R2816K4.



53270

70,00€

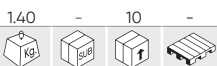

KIT DE CALADO MERCEDES/CHRYSLER/ JEEP

MARCAS	MERCEDES CHRYSLER JEEP
HERRAMIENTAS OEM	112589034000 (1), 601589024000 (2), 111589031500 (3)
CÓDIGOS DE MOTOR	HERR.: 112 589 03 40 00; 112, 113, 137, 155, 156, 272/979, 273, 629, 642/992. HERR.: 601 589 02 40 00: 102, 103, 104, 111, 601, 602.91/93/94/96/983, 603.91/93/96/97, 604, 605, 606, 611, 612/965/966, 613. HERR.: 111 589 03 15 00: 111, 119, 604, 605, 606, 611/980, 612, 613, 628, 629, 640, 642/922, 612.965/966, 646, 647, 648.

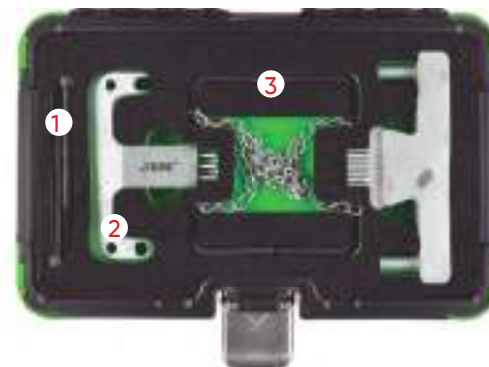

53271

227,00€



KIT DE CALADO MERCEDES M271

MARCAS	MERCEDES
HERRAMIENTAS OEM	271 589 003100 (1), 271589014000 (2), 271589001500 (3), 156589006100 (4)
CÓDIGOS DE MOTOR	M271. E18ML 2002. DE18ML 2003 - 2005. E16ML 2008. DE18LA 2009.

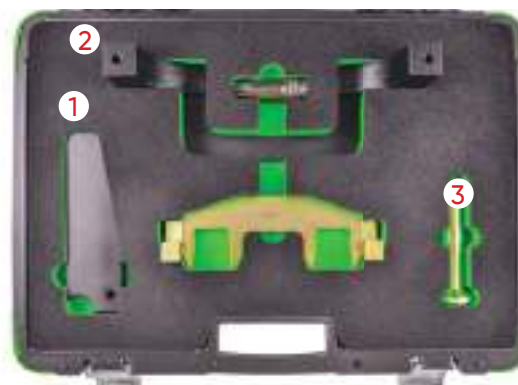

53272

195,00€

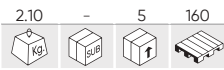

KIT DE CALADO MERCEDES AMG 156

MARCAS	MERCEDES
HERRAMIENTAS OEM	156589006100 (1), 156589003200 (2), 156589016300 (3), 156589006900 (4)
CÓDIGOS DE MOTOR	BENZ AMG 156.ML 63 AMG.S 63L AMG.S 63. AMG. R 63 AMG L 4MATIC. R63 AMG 4MATIC. E 63 AMG. CLS 63 AMG. CLK 63 AMG. CLK 63 AMG BLACK SERIES. CLK 63 AMG CABRIO. CL 63 AMG.

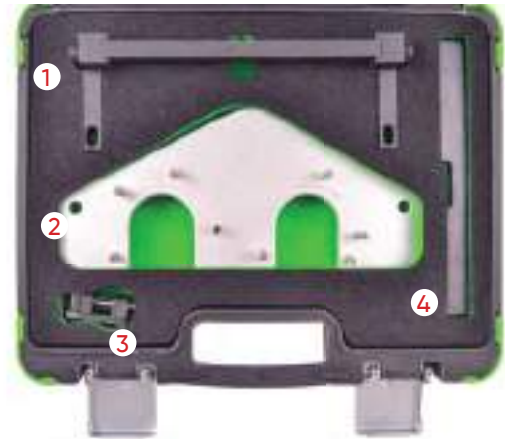

53273

75,00€

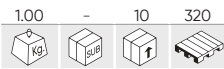

KIT DE CALADO MERCEDES M276, M157, M278

MARCAS	MERCEDES		
HERRAMIENTAS OEM	27658901400		
CÓDIGOS DE MOTOR	<table border="0"> <tr> <td>CL 500 / 63 AMG (C 216) 2010-2013. S 500 / 63 AMG (C 217) 2014. CLS 300 (C 218) 2012. E 300 / 350 / 400 (C/A 207) 2011. CLS 350 / 400 / 500 / 63 AMG (C/X 218) 2011-2014. SLK 350 (R 172) 2011. SL 350 / 400 / 500 / 63 AMG (R 231) 2012. S 500 PLUG-IN HYBRID (V 222) 2014. ML 300 / 350 / 500 / 63 AMG (W 166) 2011.</td> <td>C 400 (W 205) 2014. E 400 HYBRID (W 212) 2012. G 63 AMG (W 463) 2012. E 300 / 350 / 400 / 500 / 63 AMG (W/S 212) 2011. C 350 (W/S/C 204) 2011. S 350 / 500 / 63 AMG (W/V 221) 2010. S 400 / 63 AMG (W/V 222) 2013. R 350 BlueEFFICIENCY (W/V 251) 2012. GL 450 / 500 (X 166) 2012. GLK 350 (X 204) 2011.</td> </tr> </table>	CL 500 / 63 AMG (C 216) 2010-2013. S 500 / 63 AMG (C 217) 2014. CLS 300 (C 218) 2012. E 300 / 350 / 400 (C/A 207) 2011. CLS 350 / 400 / 500 / 63 AMG (C/X 218) 2011-2014. SLK 350 (R 172) 2011. SL 350 / 400 / 500 / 63 AMG (R 231) 2012. S 500 PLUG-IN HYBRID (V 222) 2014. ML 300 / 350 / 500 / 63 AMG (W 166) 2011.	C 400 (W 205) 2014. E 400 HYBRID (W 212) 2012. G 63 AMG (W 463) 2012. E 300 / 350 / 400 / 500 / 63 AMG (W/S 212) 2011. C 350 (W/S/C 204) 2011. S 350 / 500 / 63 AMG (W/V 221) 2010. S 400 / 63 AMG (W/V 222) 2013. R 350 BlueEFFICIENCY (W/V 251) 2012. GL 450 / 500 (X 166) 2012. GLK 350 (X 204) 2011.
CL 500 / 63 AMG (C 216) 2010-2013. S 500 / 63 AMG (C 217) 2014. CLS 300 (C 218) 2012. E 300 / 350 / 400 (C/A 207) 2011. CLS 350 / 400 / 500 / 63 AMG (C/X 218) 2011-2014. SLK 350 (R 172) 2011. SL 350 / 400 / 500 / 63 AMG (R 231) 2012. S 500 PLUG-IN HYBRID (V 222) 2014. ML 300 / 350 / 500 / 63 AMG (W 166) 2011.	C 400 (W 205) 2014. E 400 HYBRID (W 212) 2012. G 63 AMG (W 463) 2012. E 300 / 350 / 400 / 500 / 63 AMG (W/S 212) 2011. C 350 (W/S/C 204) 2011. S 350 / 500 / 63 AMG (W/V 221) 2010. S 400 / 63 AMG (W/V 222) 2013. R 350 BlueEFFICIENCY (W/V 251) 2012. GL 450 / 500 (X 166) 2012. GLK 350 (X 204) 2011.		



54318

105,00€

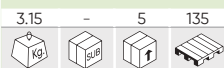

REMACHADORA DE CADENAS DE DISTRIBUCIÓN

MARCAS	CHRYSLER JEEP MERCEDES
HERRAMIENTAS OEM	112 589 026 300 (1) 103 589 016 300 (2) 602 589 026 300 (3) 602589023300 (4) 602589003900 (5) 602589046301 (6)
CÓDIGOS DE MOTOR	CHRYSLER/JEEP: 2.2D, 2.7D, 3.0D CRD (DIESEL). MERCEDES: 1.7D, 2.1D, 2.2D, 2.7D, 3.0D, 3.2D, 3.9D, 4.0D CDI (DIESEL)

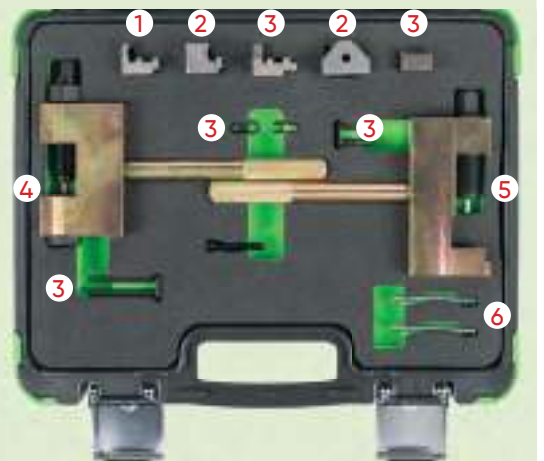

KITS DE CALADO (TIMING TOOLS)

54414

97,50€

2.50 - 5 135



N

KIT DE CALADO MERCEDES M651

MARCAS	A CLASS (2012-2018), B CLASS (2012-2019), C CLASS (2009-2015), C CLASS (2014-2018), CLA COUPE (2013-2019), CLS (2011-2018), E CLASS (2009-2016), GLA (2014-2020), GLC (2015-2019), GLE (2015-2019), GLK (2008-2015), M CLASS (2011-2015), S CLASS (2010-2013), S CLASS (2013-2017), SLK (2016-2017), SLK (2012-2016), SPRINTER (2009-2018), SPRINTER (2018-), V CLASS (2014-), VIANO (2010-2015), VITO (2010-2015), VITO (2014-) MERCEDES-BENZ
HERRAMIENTAS OEM	608 31 800 (1) 608 31 830 (2) 608 31 810 (3) 608 31 820 (4) 651 589 00 40 00 (5)
CÓDIGOS DE MOTOR	1.8: 651.901 2.1: 651.900, 651.910, 651.911, 651.912, 651.913, 651.916, 651.921, 651.922, 651.924, 651.930, 651.940, 651.950, 651.955, 651.956, 651.957, 651.958, 651.960, 651.961, 651.980 2.2: 651.925

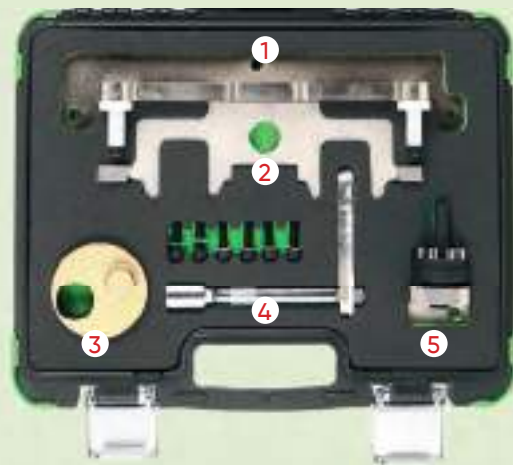

54415

60,00€

1.10 5 10 240



N

KIT DE CALADO MERCEDES M651

MARCAS	GLA X156 200/220 CDI, GLK X 204 200/220/250 CDI, ML W166 250, SLK R172 250 CDI, SPRINTER W906 210/310/510/213/313 CDI, SPRINTER W906 513/216/316/416/516 CDI, V-CLASS W/V 639 2.0/2.2 CDI, VITO W/V 639 110/113/116 CDI MERCEDES-BENZ: A-CLASS W176 180/200/220 CDI, B-CLASS W246 200/220 CDI, C-CLASS W/S/C 204 180/200/220/250 CDI, CLA C117 200/220 CDI, CLD C/X 218 220/250, E-CLASS W/S 212 200/220/250 CDI E-CLASS C/A 207 220/250 CDI, E-CLASS W212 250/300 BLUETEC
HERRAMIENTAS OEM	651589004000 (1) 651589014000 (2)
CÓDIGOS DE MOTOR	1,8 651.901 2,1 651.900 651.910 651.911 651.912 651.913 651.916 651.921 651.922 651.924 651.925 651.930 651.940 651.950 651.955 651.956 651.957 651.958 651.960 651.961 651.980

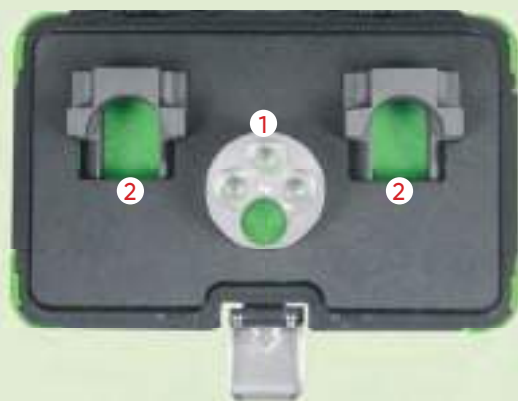

54416

31,00€

1.10 5 10 240



N

KIT DE CALADO MERCEDES M642

MARCAS	G-CLASS (461/463) 2007-2015, GL-CLASS (164/166) 2006-2016, GLE/GLE COUPE (166/292) 2020 GLK (204) 2008-2015, GLS (166) 2016-2019, M-CLASS (164/166) 2005-2015, R-CLASS (251) 2005-2013, S-CLASS (221/222) 2005-2017, SPRINTER (906) 2006-2018, VIANO (639) 2005-2015, VITO (639) 2006-2015 MERCEDES-BENZ: C-CLASS (203/204) 2004-2014, CLK (209) 2005-2009, CLS (219/218) 2005-2018, E-CLASS (211/212/213) 2005-2018, E-CLASS COUPE/CABRIOLET (207) 2009-2017
HERRAMIENTAS OEM	642589003100 (1)
CÓDIGOS DE MOTOR	642.820 642.822 642.826 642.830 642.832 642.834 642.835 642.836 642.838 642.850 642.852 642.853 642.854 642.855 642.856 642.858 642.861 642.862 642.867 642.868 642.870 642.872 642.884 642.886 642.890 642.896 642.910 642.920 642.921 642.922 642.930 642.932 642.940 642.950 642.960 642.961 642.970 642.975 642.990 642.992 642.993

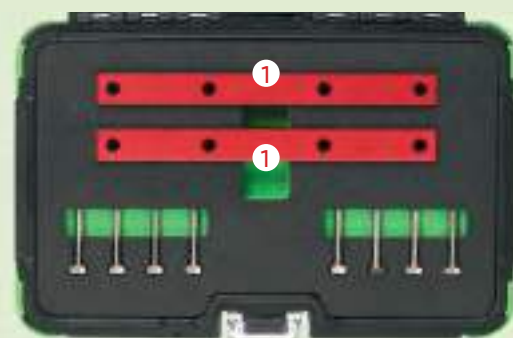

54417

153,00€



N

KIT DE CALADO MERCEDES M133, M270, M274

MARCAS	MERCEDES.BENZ A -CLASS (W176) (2012), MODEL A180/A200 MERCEDES.BENZ B CLASS (W246) AS OF 2011, MODEL B180/B200
HERRAMIENTAS OEM	270589006100 (1)
CÓDIGOS DE MOTOR	M133 M270 M274

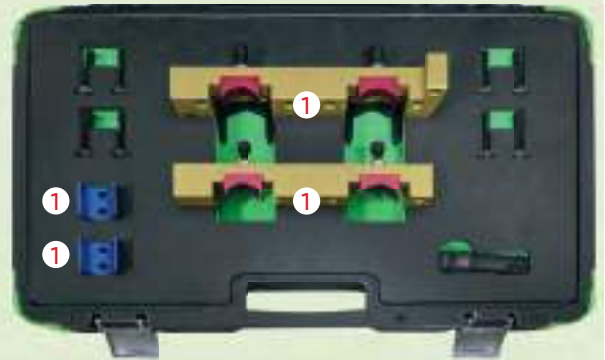

54418

37,00€



N

KIT DE CALADO MERCEDES M112, M113

MARCAS	C-CLASS (202) 2.4/2.6/2.8/3.2/4.3 - 1998-00, CLK (208) 3.2/4.3/5.4 - 1997-03, E-CLASS (210) 2.4/3
HERRAMIENTAS OEM	112589003200 (1) 112589013200 (2) 112589000100 (3)
CÓDIGOS DE MOTOR	MERCEDES.BENZ: M112, M113

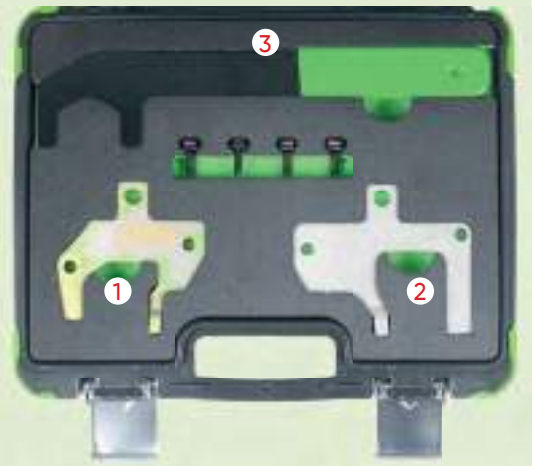

51488

16,00€

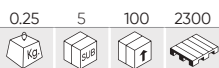

BLOQUEADOR DE CIGÜEÑAL Y ÁRBOL DE LLEVAS PARA RENAULT/NISSAN/DACIA/SUZUKI

MARCAS	RENAULT: CAPTUR, CLIO II,III,IV, ESPACE/GRAND ESPACE III,IV, FLUENCE, KADJAR, KANGOO, LAGUNA I,II,III, LOGAN/ LOGAN MCV, MEGANE I,II,III,IV, MODUS/GRAND MODUS, SCENIC/ GRAND SCENIC I,II,III,IV, TWING II, TRAFIC II, MASTER II 1.5DCI & 1.9 DCI. DACIA: DOKKER, DUSTER, LODGY, LOGAN, SANDERO 1.5DCI NISSAN: ALMERA, CUBE, JUKE, KUBISTAR, MICRA, NOTE, NV200/EVALIA, PRIMERA, TIIDA, INTERSTAR, PRIMASTAR 1.5DCI & 1.9 DCI SUZUKI: GRAND VITARA, JIMNY 1.5DDIS & 1.9DDIS
HERRAMIENTAS OEM	MOT1489, MOT1430, MOT1054.
CÓDIGOS DE MOTOR	K9K, F8Q, F9Q - Gasolina, Clío, R19, Laguna 1.8/2.0 Motor de códigos: F3R F3P



KITS DE CALADO (TIMING TOOLS)

53289

45,00€

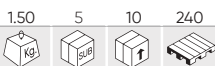

KIT DE CALADO RENAULT 1.4, 1.6, 1.8, 2.0 16V

MARCAS	<p>RENAULT: ESPACE/GRAND ESPACE (98-02), ESPACE/GRAND ESPACE IV (02-10), KANGOO/TREKKA (01-09), LAGUNA (98-01), LAGUNA II (01-07), LAGUNA III (07-13), MEGANE (99-03), MEGANE II (02-10), MEGANE III/SPORT (08-13), MEGANE/SCENIC (99-00), SCENIC/RX4 (99-03), SCENIC/GRAND SCENIC II (03-09), TRAFIC II (01-11), TWINGO II (08-14), VEL SATIS (00-10), WIND (10-14)</p> <p>DACIA: LOGAN/MCV (05-11).</p> <p>NISSAN: KUBISTAR X76 (03-09), PRIMASTAR (02-11).</p> <p>VAUXHALL/OPEL: JETTA, TOURAN, GOLF, GOLF PLUS, POLO, PASSAT, TIGUAN, SCIROCCO.</p>
HERRAMIENTAS OEM	MOT1489 (1), MOT1054 (2), MOT1496 (3)
CÓDIGOS DE MOTOR	<p>1.4 16V K4J: 730, 732, 740.</p> <p>1.6 16V K4M: 752, 753, 760, 761, 764, 788, 812, 813, 854, 856.</p> <p>1.8 16V F4P: 720, 722, 760, 770, 771, 772, 773, 774, 775.</p> <p>2.0 16V F4R: 700, 701, 712, 713, 714, 715, 720, 722, 730, 732, 736, 738, 740, 741, 744, 746, 747, 762, 763, 764, 765, 766, 767, 770, 771, 780, 790, 791, 792, 820, 830, 832, 867.</p> <p>2.0 16V F4R(TT): 720, 722, 764, 765, 774, 776, 784, 786, 787, 794, 795, 796, 797, 800, 802, 810, 811, 870, 872, 874, 886, 887, 896, 897.</p>

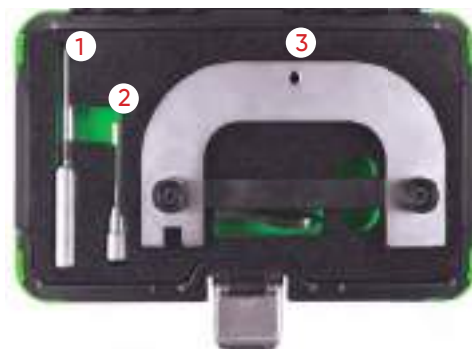

53290

51,00€

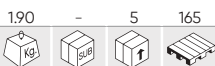

KIT DE CALADO RENAULT/VOLVO 16V, 20V

MARCAS	<p>RENAULT: LAGUNA 2.0 16V / 2.5 20V (1996-1999), SAFRANE 2.0 16V / 2.5 20V (1996-2001)</p> <p>VOLVO: 850 (1992-1997), C70 (1998-2002), S40 (1996-2004), V40 (1996-2004), S60 (2001-2005), S70 (1997-2000), S80 (1999-2005).</p>
HERRAMIENTAS OEM	MOT1348 (1), MOT1337 (2), MOT1340 (3)
CÓDIGOS DE MOTOR	<p>RENAULT: N7Q 704/710/711(2.0 16V), N7U 700/701(2.5 20V).</p> <p>VOLVO: B4164S, B4164S2, B4184S, B4184S2, B4184S3, B4184S9, B4184S10, B4194T, BS194T2, B420S4, B4204S2, B4204T, B4204T2, B4204T3, B4204T5, B5202FS, B5204FT, B5204T2, B5204T3, B5204T4, B5204T5, B5234FS, B5204FT, B5234T3, B5234T4, B5234T5, B5234T6, B5234T7, B5234T8, B5234T9, B5244S, B5244S2, B5244SG, B5244SG2, B5244T, B5244T3, B5244T4, B5244T5, B5244T7.</p>

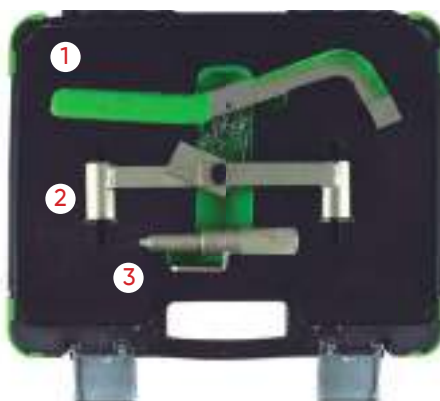

53291

68,00€



KIT DE CALADO RENAULT

MARCAS	RENAULT: CLIO, LAGUNA, MEGANE
HERRAMIENTAS OEM	MOT1496 (1), MOT1489 (2), MOT861/1863 (3), MOT1490(4)
CÓDIGOS DE MOTOR	K4J, K4M, F4P, F4R.

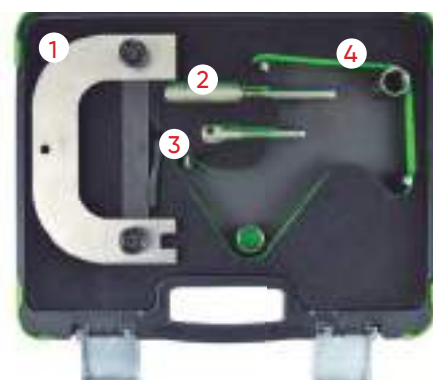

53292

116,00€

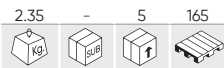

KIT DE CALADO RENAULT/OPEL 2.2, 2.5 TDI DCI

MARCAS	RENAULT: LAGUNA II, ESPACE, MASTER, TRAFIC, 2.2 / 2.5 DCI OPEL: VIVARO, MOVANO, DIESEL: 2.2 / 2.5 DTI, ASTRA B, VECTRA B, SIGNUM, ZAFIRA, 2.2 16V
HERRAMIENTAS OEM	KM6205 (1), KM6204 (2), KM6077 (3)
CÓDIGOS DE MOTOR	2.2 / 2.5



53311

97,00€

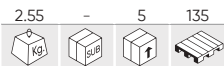

KIT DE CALADO RENAULT/NISSAN/OPEL/VAUXHALL 2.0, 2.3 DCI, CDTI, M9R, M9T

MARCAS	NISSAN: PRIMASTAR X83 (06-15), QASHQAI/QASHQAI+2 J10 (07-14), X-TRAIL T31 (07-14). VAUXHALL/OPEL: MOVANO-B (10-17), VIVARO (06-15). RENAULT: ESPACE/GRAND ESPACE IV (06-10), KOLEOS (08-15), LAGUNA LL (05-07), LAGUNA LLL (07-14), MASTER LLL (10-15), MEGANE LL (06-10), SCENIC/GRAND SCENIC LL (06-09), SCENIC/GRAND SCENIC LLL (09-15), TRAFIC LL (06-14), VEL SATIS (05-10)
HERRAMIENTAS OEM	MOT1769 (1), EN-48334 (2), MOT1766 (3), EN-48330 (3), KM-6130 (4), EN-48332 (5), MOT1773 (6), EN-48831 (6)
CÓDIGOS DE MOTOR	2.0D DCI M9R: 630, 780, 782, 784, 786, 788, 830, 832, 833, 834, 835, 836, 838, 855, 856. 2.0D CDTI M9R: 630, 780, 782, 784, 786. 2.3 BI-CDTI: LP6/M9T706, LW7/M9T706. 2.3D DCI M9T: 670, 672, 676, 678, 680, 686, 690, 692, 694, 698.



53523

91,00€



KIT DE CALADO RENAULT/NISSAN/OPEL 1,6DCI

MARCAS	RENAULT: ESPACE/GRAND ESPACE IV (06-10), KALEOS (08-11), LAGUNA LL (05-07), LAGUNA LLL (07-12), MASTER LLL (10-12), MAGANE LL (06-10), SCENIC/GRAND SCENIC LL (06-09), SCENIC/GRAND SCENIC LLL (09-12), TRAFIC LL (06-12), VEL SATIS (05-10) NISSAN: PRIMASTAR X83 (06-10), QASHQAI/QASHQAI+2 J10 (07-10), X-TRAIL T31 (07-12). VAUXHALL / OPEL: MOVANO-B (10-12), VIVARO (06-12).
HERRAMIENTAS OEM	MOT1969 (1), MOT1970 (2), MOT1770, MOT1773, EN-48330, EN-48332, EN-48334, EN-48831, KM-6130
CÓDIGOS DE MOTOR	M9R 2.0DCI: 610, 615, 630, 700, 721, 740, 742, 760, 761, 762, 763, 780, 782, 784, 786, 788, 800, 802, 803, 805, 808, 816, 830, 832, 833. M9T 2.3DCI: 670, 672, 676, 678, 680, 686, 690, 692, 694, 698.



54210

84,00€



HERRAMIENTA DE BLOQUEO DE ÁRBOL DE LEVAS PARA RENAULT 1.8, 2.0 16V

MARCAS	RENAULT LAGUNA II (2001 - 2009), MEGANE II (2002 - 2009), Scenic (2002 - 2009)
HERRAMIENTAS OEM	MOT 1509-01 (1), 1509 (2)
CÓDIGOS DE MOTOR	700, 701, 712, 713, 714, 715, 720, 721, 722, 722, 730, 732, 736, 738, 740, 741, 744, 746, 747, 760, 761, 762, 763, 764, 765, 766, 767, 770, 771, 773, 774, 774, 775, 776, 784, 786, 787, 790, 792, 794, 797, 830, F4P, F4R



54225

133,00€



KIT DE BLOQUEO DEL VOLANTE/ POLEA DEL CIGÜEÑAL PARA RENAULT/NISSAN

MARCAS	NISSAN: PRIMASTAR (06-15), QASHQAI/QASHQAI+2 (07-14), X-TRAIL (07-14), NAVARA (15-16), NV400 (11-16) RENAULT: ESPACE V (15-16), CLIO (06-16), FLUENCE (09-15), LAGUNA (05-15), LATITUDE (10-15), MEGANE (06-15), SCENIC/ GRAND SCENIC (06-15), ESPACE/GRAND ESPACE IV (02-15), KOLEOS (08-16), TRAFIC II (07-15), VEL SATIS (00-10), MASTER III (10-16)
HERRAMIENTAS OEM	MOT 1431(1), MOT 1716(2), MOT 2019(2), MOT 1789(3), MOT 919-02(4)
CÓDIGOS DE MOTOR	1.4:H4.JT700 1.6:M5M400, M5M450 2.0:M4R700, M4R701, M4R704, M4R711, M4R713, M4R714, 2.0D:M9R726, M9R730, M9R735, M4R737, M9R740, M4R746, M9R742, M9R744, M9R746, M9R748, M4R750, M4R751, M4R752, M4R753, M4R754, M9R610, M9R613, M95615, M9R630, M9R750, M9R760, M9R761, M9R762, M9R762, M9R763, M9R700, M9R721, M9R722, M9R724, M9R756, M9R780, M9R782, M9R800, M9R802, M9R803, M9R804, M9R805, M9R806, M9R808, M9R809, M9R811, M9R812, M9R814, M9R815, M9R816, M9R817, M9R820, M9R824, M9R828, M9R830, M9R832, M9R833, M9R834, M9R835, M9R836, M9R838, M9R839, M9R844, M9R845, M9R846, M9R849, M9R854, M9R855, M9R856, M9R857, M9R858, M9R859, M9R865, M9R866, M9R784, M9R786, M9R788 2.3D:M9T670, M9T672, M9T676, M9T678, M9T680, M9T686, M9T690, M9T692, M9T694, M9T696, M9T698, M9T700, M9T702, M9T706, M9T708, M9T870, M9T880, M9T890, M9T896, M9T898, M9T899, YS23DDT, YS23DDTT 2.5:2TR700, 2TR702, 2TR703, 2TR704, 2TR705, 2ZV604, V4U604, VQ25 3.5:V4Y701, V4Y711, V4Y713, V4Y715



TU KIT DE CALADO
AÚN MÁS CERCA

INTRODUCE EN TU BUSCADOR WEB EL
CÓDIGO DE LAS HERRAMIENTAS OEM
O EL CÓDIGO MOTOR DE TU COCHE Y
ENCUENTRA TU KIT DE CALADO COMPATIBLE

54289

38,00€

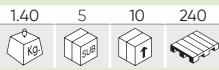

N

KIT DE BLOQUEO DEL VOLANTE DE INERCIA PARA MERCEDES/RENAULT/DACIA/NISSAN

MARCAS	DACIA DOKER 2015 + DACIA DUSTER 2015+ DACIA LODGY 2015+ DACIA LOGAN 2013/-2020 DACIA SANDERO 2013+ MERCEDES-BENZ A-CLASS 2018+ MERCEDES-BENZ B-CLASS 2019+ MERCEDES-BENZ CLA 2019+ MERCEDES-BENZ GLA 2019+ MERCEDES-BENZ GLB 2019+ RENAULT ARKANA 2019+ RENAULT CAPTUR 2018+ RENAULT CLIO V 2019 + RENAULT KADJAR 2018+ RENAULT MEGANE IV 2017+ RENAULT SCENIC/GRAND SCENIC IV 2018+ RENAULT TALISMAN 2018+
HERRAMIENTAS OEM	MOT.2188 (1)
CÓDIGOS DE MOTOR	HR13DDT, H4Bt 400, H4Bt 408, H4Bt 410, H4Bt 411, H4M 730, H4M 738, H4M 740, H5H 450, H5H 470, H5H 480, 282.914



54438

40,00€



N

KIT DE CALADO RENAULT/NISSAN 3.0DCI

MARCAS	NISSAN: NAVARA PICK UP, PATHFINDER, INFITI RENAULT: LAGUNA, LATITUDE
HERRAMIENTAS OEM	MOT 1880 (1) MOT 1970 (2) MOT 1874 (3)
CÓDIGOS DE MOTOR	V9X, V9X 791, 891



54439

32,50€

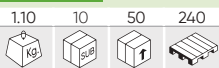

N

BLOQUEADOR DE POLEA DEL CIGÜEÑAL RENAULT/DACIA 0.9, 1.0, 1.2, 1.6 TCE

MARCAS	DACIA DOKKER 2012 - 2019, PLUMERO 2013 - 2018, LOGIA 2012 - 2018 RENAULT CAPTURAR 2013 - 2019, CLIO IV 2012 - 2019, KADJAR 2015 - 2018, KANGOO II 2013 - EN, MEGANE III 2012 - 2017, MEGANE IV 2016 - 2020, ESCÉNICO/GRAN ESCÉNICO III 2012 - 2017, ESCÉNICO/GRAN ESCÉNICO IV 2016 - 2018, TWIN-GO III 2014 - EN
HERRAMIENTAS OEM	MOT. 2006 (1) MOT. 2054 (1) 281589004000 (1)
CÓDIGOS DE MOTOR	0.9TCE: H4B 453, H4Bt 400, 401, 408, 410, 411, 451. 1.0TCE: H4D, H4D 400, 450, 460, 470 1.2TCE: H5Ft 400, 403, 404, 405, 408, 410, 412. 1.6TCE: H4M 429, 438, 440, 729, 730, 738, 740, 748, 749

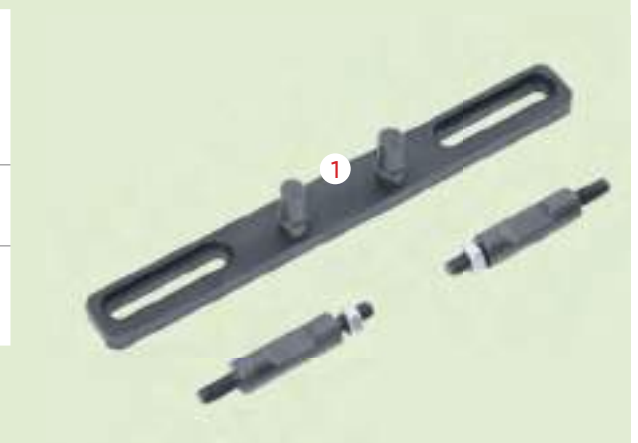

KITS DE CALADO (TIMING TOOLS)

53299

291,00€

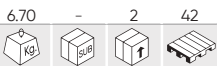

KIT DE CALADO OPEL/VAUXHALL

MARCAS	OPEL / VAUXHALL
HERRAMIENTAS OEM	EN-46788 (1), KM927 (2), EN-46789 (3), KM929 (4), EN-46785 (5), EN-46788 (6), 1 860 985 000 (7), KM932 (8), KM933 (9), EN-49978 (10), KM933 (11)
CÓDIGOS DE MOTOR	1.3 CDTI 16V, 1.9 CDTI, 2.0 DTI, 2.2 DTI.



53300

41,00€

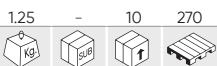

KIT DE CALADO OPEL/VAUXHALL/CHEVROLET 2,0CDI

MARCAS	OPEL VAUXHALL CHEVROLET
HERRAMIENTAS OEM	EN-48245 (1), EN-48246 (2), 205083060 (3) (4) (5) (6)
CÓDIGOS DE MOTOR	OPEL / VAUXHALL: Z20DM, Z20DMH CHEVROLET: LLWZ20DMH, RA 420 , Z20SI, Z 20S3, Z 20S4, Z 20S5



53301

44,00€



KIT DE CALADO SUZUKI/OPEL 1.0, 1.2, 1.4

MARCAS	SUZUKI: WAGON R (05-08). VAUXHALL / OPEL: AGILA (00-08), ASTRA-G (98-06), ASTRA G CLASSIC II (03-10), ASTRA-H (04-11), COMBO (04-12), CORSA-B (97-00), CORSA-C (00-07), CORSA-D (06-12), MERIVA-A (04-10), TIGRA-B (04-10).
HERRAMIENTAS OEM	KM-953/09919-58310 (1), KM-952/09912-38310 (2), KM-954/09919-08310 (3), KM-6130 (4), KM-955/09919-58320 (5)
CÓDIGOS DE MOTOR	1.0 12V: X10XE, Z10XE, Z10XEP. 1.2 16V: X12XE, Z12XE, Z12XEP. 1.4 16V/ECOFLEX: Z14XEL, Z14XEP.

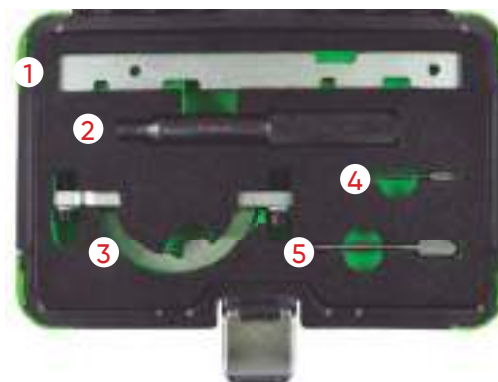

53302

44,00€

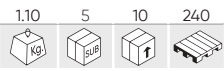

KIT DE CALADO FIAT/ALFA ROMEO/VAUXHALL/OPEL/SAAB JTD

MARCAS	SAAB: 9-3 (04-08), 9-5 (05-08). VAUXHALL / OPEL: ASTRA-H, VECTRA-C, SIGNUM (04-07), ZAFIRA-B (05-07).
HERRAMIENTAS OEM	EN46789/32 025 008 (1) (3), EN46788/32 025 009 (2), KM6349 (4)
CÓDIGOS DE MOTOR	Z19DT, Z19DTH, Z19DTL.



53305

136,00€

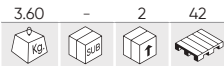

KIT DE CALADO SAAB/OPEL/VAUXHALL

MARCAS	VAUXHALL / OPEL: ANTARA (06-10), CALIBRA (93-98), CAVALIER/VECTRA-A (93-95), OMEGA-B (94-03), SIGNUM (03-05), SINTRA (96-99), VECTRA-B (95-02), VECTRA-C (02-05). SAAB: 900 (93-98), 9000 (95-97), 9-5 (98-03)
HERRAMIENTAS OEM	KM-800-1 (1), KM-800-2 (2), KM-800-20 (3), KM-800-10 (4), 83 95 006 (5), KM-800-30 (6), MKM-6038, 83 95 006 (7)
CÓDIGOS DE MOTOR	2.5 V6: SAAB: B2581, VAUXHALL/OPEL: C25XE, X25XE. 2.6 V6: VAUXHALL/OPEL: Y26SE. 3.0 V6: SAAB: B308E, B308I, VAUXHALL / OPEL: X30XE. 3.2 V6: VAUXHALL/OPEL: Y32SE, .

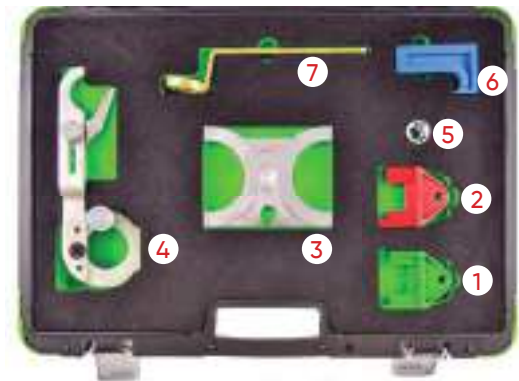

53307

38,50€



KIT DE CALADO ALFA/OPEL/VAUXHALL 1.6, 1.8 16V

MARCAS	OPEL / VAUXHALL: CORSA-D, AGILA, ASTRA-G-H, MERIVA, ZAFIRA-B, VECTRA-C, SIGNUM, INSIGNA	1.6, 1.8
	CHEVROLET: AVEO, CRUZE, ORLANDO	1.4, 1.6, 1.8
	ALFA ROMEO: 159 FIAT: CROMA	1.8
HERRAMIENTAS OEM	E10290 (1), 23056-06 (2) (3), E10230 (4), 23164-04 (5), 23174-01 (6), 23056-05 (7)	
CÓDIGOS DE MOTOR	OPEL / VAUXHALL: Z16LEL, Z16LER, Z16LET, Z16XE1, Z16XEP, Z16XER, A16XER, 18XER, A18XER, 2HO/A18XEL. CHEVROLET: G14D, LDD, LXV (F16D4), 2HO(Z18XER). ALFA / FIAT: 939A4.000.	

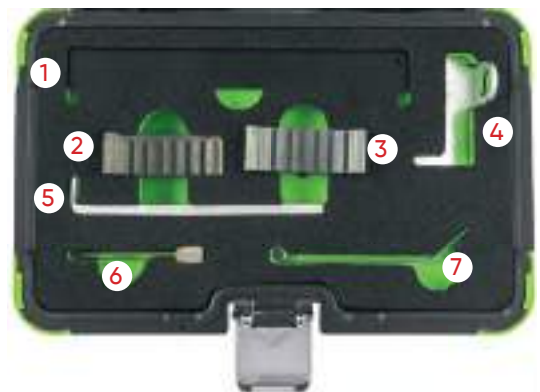

KITS DE CALADO (TIMING TOOLS)

53316

34,00€

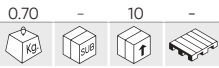

KIT DE CALADO FIAT/OPEL/VAUXHALL 2.2 16V CADENA

MARCAS	OPEL: ASTRA-G (2000-2006), ASTRA-H (2006-2011), SIGNUM (2003-2008), VECTRA-B (2000-2002, VECTRA-C (2002-2008), ZAFIRA-A (2000-2005), ZAFIRA-B (2005-2012), SPEEDSTER (2000-2006). VAUXHALL: VX220 (2000-2006). FIAT: CROMA (2005-2009).
HERRAMIENTAS OEM	VAUXHALL / OPEL: Z22SE, Z22YH FIAT: 194A1.000.



53317

34,00€

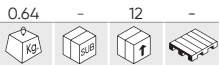

BLOQUEADOR BOMBA AINTICONGELANTE OPEL/VAUXHALL 2.2

MARCAS	OPEL 2.2 Cadena VAUXHALL 2.2 Cadena
--------	--



53452

26,50€

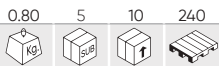

KIT DE CALADO PARA OPEL/FORD/FIAT/ ALFA ROMEO/LANCIA/SUZUKI

MARCAS	VAUXHALL/OPEL 1.3 CDTI: AGILA, CORSA, COMBO (03-08), ASTRA-H(05-08), MERIVA, TIGRA-B(04-08) SUZUKI 1.3 DDIS: IGNIS, WAGON R(03-08), SWIFT(04-08) FORD: 1.3 TDCI FIAT/ALFA ROMEO/LANCIA: 1.3 JTD MULTIJET
HERRAMIENTAS OEM	104-A EN 46781 (1) , EN 46785 (2)

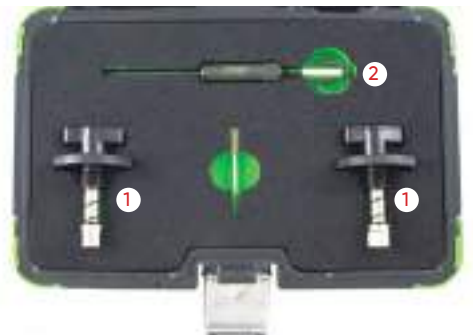

53651

91,00€



KIT DE CALADO OPEL/VAUXHALL 1.0, 1.2, 1.4 TURBO

MARCAS	OPEL: ADAM, AMPERA, ASTRA-J, AVEO, CORSA-D, INSIGNIA, MERIVA-B, MOKKA, ZAFIRA-C TOURER
HERRAMIENTAS OEM	EN 49977-100 (1), EN 49977-200 (2), EN 49978 (3), KM 952 (4), KM 953-A (5), KM 955-1 (6), KM 955-2 (7).
CÓDIGOS DE MOTOR	1.0: A10XEP (LDB) 1.2: A12XEL (LWD), A12XER (LDC) 1.4: A14XEL (L2Z), A14XER (LDD), LDU A14NEL (LUH), A14NET (LUJ), TWINPORT / ECOFLEX ENGINES A14XFL (LUU), A14NEL (LDD), A14NEL (LUJ), A12XEL (L2Q)



54205

49,00€

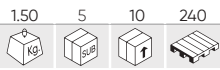

KIT DE CALADO PARA VAUXHALL/OPEL 1.6 CDTI

MARCAS	VAUXHALL/OPEL: Astra J (13-18), Astra K, (15-19), GTC (15-18), Insignia A (15-17), Insignia- B (17-20), Meriva B (13-17), Mokka (14-16), Mokka X (16-20), Zafira C Tourer (13-19).
HERRAMIENTAS OEM	EN-6349, EN-6130 (1), EN-51143 (2), EN-51140 (3), EN-50513 (4), EN-51188 (5)
CÓDIGOS DE MOTOR	B16DTC, B16DTE, B16DTH, B16DTJ, B16DTL, B16DTN, B16DTR and B16DTU. D16DTH, D16DTI, D16DTJ, D16DTN, D16DTR, D16DTU

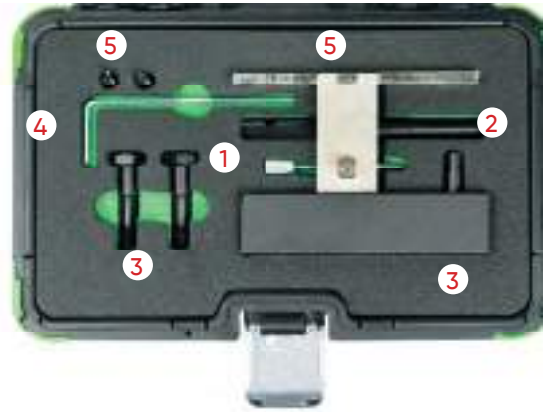

54214

96,00€

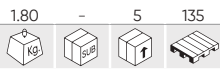

KIT DE CALADO PARA OPEL/ISUZU 1.6D, 1.7D

MARCAS	ASTRA, CAVALIES, VECTRA-A(87-00), ISUZU, NOVA, CORSA / COMBO, STRA, CAVALIER, VECTRA, FRONTERA, MONTEREY, MIDI, BRAVA (88-04)
HERRAMIENTAS OEM	VAS 6079 (1), KM 951 (2), KM 851 (3), 23-029 (4), KM 661-2 (5), KM 661 (6)
CÓDIGOS DE MOTOR	OPEL : 16DA, 17D, 17DR, X17DTL ISUZU : 4EC1, 4EE1, 4JB1, 4XJ1, 4JA1, 4JG1, 4FC1, 4FD1, 4FG1, Z17DT, Y17DT/DTL

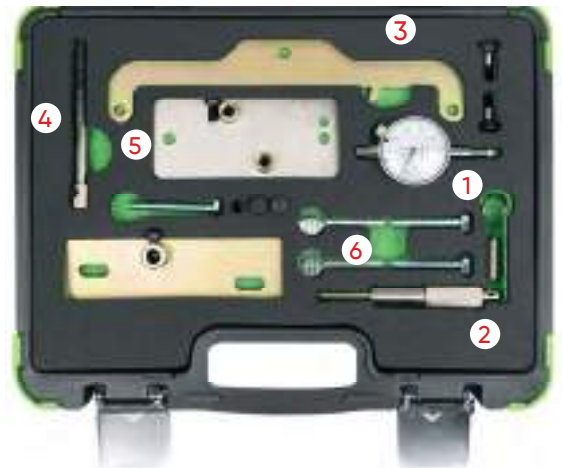

54217

104,00€



KIT DE CALADO PARA VAUXHALL/OPEL/SAAB 2.0, 2.2 DTI

MARCAS	VAUXHALL/OPEL: ASTRA-G (98-06), FRONTERA-B (98-04), OMEGA-B, (98-03), SIGNUM (03-05), SINTRA (98-99), VECTRA-B (97-02), VECTRA-C (02-05), ZAFIRA-A (99-05), SAAB: 9-3 (98-04), 9-5 (02-06)
HERRAMIENTAS OEM	SAAB: 83 95 394 (1), 83 95 337 (2), 83 95 352 (3), 83 95 386 (4) VAUXHALL/OPEL/SAAB: KM-927 (2), KM-929 (3), KM-932 (4), KM-933 (1)
CÓDIGOS DE MOTOR	OPEL: X20DTH, X20DTL, Y20DTH, Y20DTL, X22DYH, Y22DTH, Y22DTR SAAB: D223L



54221

111,00€



KIT DE CALADO PARA VAUXHALL/OPEL 1.3 CDTI

MARCAS	VAUXHALL/ OPEL 1.3 CDTI Corsa E Diesel Engine From 2015
HERRAMIENTAS OEM	KM-662-C (1), EN-50515 (2), EN-51500 (3), EN-46775 (4), KM-955-1 (5), EN-46785 (6)
CÓDIGOS DE MOTOR	LKU B13DTE, LKU B13DTR



54434

48,50€



KIT DE CALADO OPEL 1.0, 1.4

MARCAS	VAUXHALL/OPEL ADAM 2014 - 2019,ASTRA-K 2015 - 2019,CORSA-E 2015 - 2019,INSIGNIA-B 2017 - 2020,MOKKA X 2016 - 2019,VIVA (KARL) 2015 - 2020
HERRAMIENTAS OEM	EN-51367 (1) EN-51298 (2) EN-51632 (3)
CÓDIGOS DE MOTOR	1.0 L5Q/B10XE, L5Q/D10XE, LE1/B10XFL, LE1/B10XFT, LE1/B10XFL, LE1/D10XFL, LE1/D10XFT, LE1/F10XFL, LE1/F10XFT, LWT/B10XL 1.4 LE2/B14XFL, LE2/B14XFT, LE2/D14XFL, LE2/D14XFT, LFE/B14XNT, LFE/D14XNT, LV7/B14XE 1.5 LFV/B15XHT, LFV/D15XHL, LFV/D15XHT

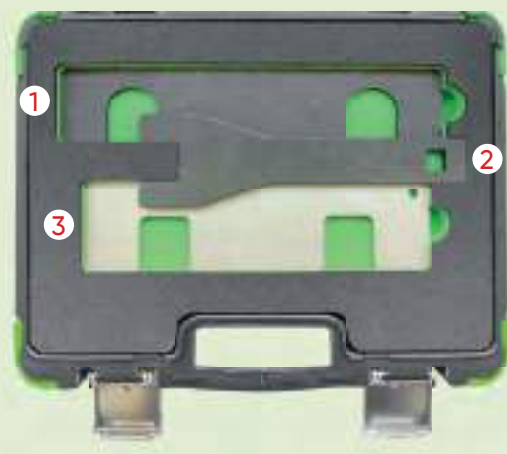

54435

14,50€



KIT DE CALADO OPEL/CHEVROLET/SAAB 1.4, 1.6, 1.8 ECOTEC

MARCAS	CHEVROLET: LACETTI (2005-2010), NUBIRA (2005-2010) OPEL/VAUXHALL: ASTRA-G (1998-2004), ASTRA-H (2004-2007), COMBO-C (2005-2012), CORSA-C (2000-2007), MERIVA-A (2003-2010), SIGNUM (2003-2007), TIGRA-B (2004-2010) VECTRA-B (1995-2002), VECTRA-C (2002-2008), ZAFIRA-A (1999-2005), ZAFIRA-B (2006-2013) SAAB: 9-3 (2003-2010)
HERRAMIENTAS OEM	KM-911 (1) KM-6130 (2) KM-852 (3), EN-852 (3)
CÓDIGOS DE MOTOR	1.4: X14XE,Z14XE 1.6: X16SEJ,X16XEL,Y16XE,Z16XE,Z16YNG 1.8: F18D3 1.8: X18XE1,Z18XE,Z18XEL,X18E1 1.8: Z18XE



54436

124,00€



N

KIT DE CALADO OPEL 1.6 SIDI

MARCAS	VAUXHALL ASTRA-J 2013 - 2017,ASTRA-K 2015 - 2019,CASCADA 2013 - 2019,GTC 2015 - 2019,INSIGNIA 2013 - 2017,INSIGNIA-B 2018 - 2020,ZAFIRA-C TOURER 2014 - 2019
HERRAMIENTAS OEM	EN 51153 (1) EN 50513 (2) EN 51148 (3) EN 51147 (4)
CÓDIGOS DE MOTOR	1,6 LWC/A16SHT LVP/A16XHT LWC/B16SHL LWC/B16SHT LVP/B16XHT LWC/D16SHJ LWC/D16SHL LWC/D16SHT



54437

110,00€



N

KIT DE CALADO OPEL/CHEVROLET/SAAB 2.0, 2.4

MARCAS	CHEVROLET CAPTIVA 2011 - 2015,HHR 2008 - 2009, MALIBU 2012 - 2015 SAAB 9-3 (02-12) 2010 - 2012,9-5 (10-12) 2010 - 2012 VAUXHALL/OPEL ANTARA 2011 - 2016,ASTRA-J 2012 - 2017,GTC (15-19) 2015 - 2019,INSIGNIA-A (08-17) 2008 - 2013
HERRAMIENTAS OEM	EN-48585 (1) EN 43653 (2), J 43653 (2) EN 955 10 (3), KM 955 (3) EN-955-20 (4), KM 955-20 (4) EN 45027 1 (5), J 45027 1 (5) EN 45027 (6), EN45027 2 (6), J 45027 2 (6) EN 49212 (7), EN 49212 1 (7) EN 49212 (8), EN 49212 2 (8) EN 48953 (9)
CÓDIGOS DE MOTOR	LHU/A20NFT 2,0: LDK/A20NHT 2,0: LDK/A20NHT, LHU/A20NET, LHU/A20NFT, LHU/B20NFT 2,4: A24XE (LE5), A24XF (LE9) 2,4: LE5,LE9

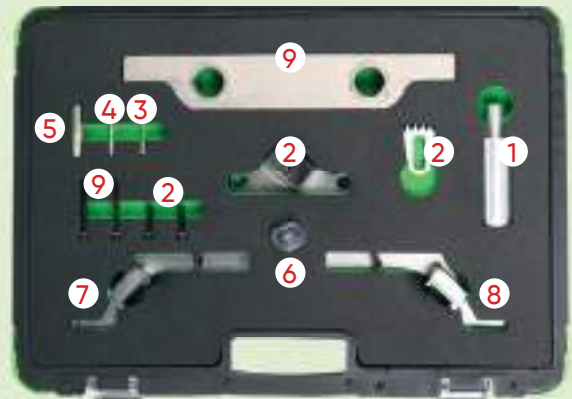

52271

18,00€

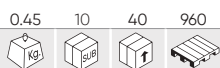

ÚTILES DE CALADO DE DISTRIBUCIÓN VAG

MARCAS	AUDI: A2 1.4TDI (02-06), A3 1.9, 2.0TDI (02-08), A4 1.6TDI (02-05), A4 1.9, 2.0TDI (04-08), A6 1.9TDI (02-05). SEAT: ALTEA 1.9SDI/TDI (05-08), LEON 1.9, 2.0TDI (05-08), TOLEDO 1.9SDI/TDI (05-08). SKODA: FABIA 1.4TDI (03-06), OCTAVIA II 2.0TDI (03-06) VW :BEETLE 1.9TDI (02-08), BORA 1.9TDI (02-08), FOX 1.4TDI (02-08), GOLF 1.9, 2.0TDI (02-08), LUPO 1.4TDI (02-08), POLO 1.4, 1.9TDI (02-08), SHARAN 1.9TDI (02-08).
HERRAMIENTAS OEM	AUDI: AMF, ASZ, ATD, AVB, AVF, AWX, AXR, AZV, BHC, BKC, BKD, BKE, BLB, BMN, BNA, BPW, BRB, BR, BRD, BRE, BRF, BUY, BVA, BVF, BVG. SEAT: BJB, BKC, BLS, BMM, BXE SKODA: AMF, AZV, BKD VW: AJM, AMF, ANU, ARL, ASZ, ATD, AUJ, AVB, AVF, AWX, AXR, BAY, BMS, BNM, BNV, BWB



KITS DE CALADO (TIMING TOOLS)

51489

12,00€

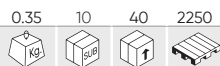

SET DE BLOQUEO DEL ÁRBOL DE LEVAS VAG 1.4, 1.6

MARCAS	VW: LUPO 99, POLO 95, CADDY 96, POLO CLASSIC, VARIANT 96, BEETLE 1.4L 99, GOLF 1.4L, 1.6L 98 Y 1.4L, BORA, 1.6L 99. AUDI: A2.
HERRAMIENTAS OEM	T10016
CÓDIGOS DE MOTOR	1.4 / 1.6 16V



53274

30,50€



KIT DE CALADO VOLKSWAGEN/SEAT/SKODA 1,2L

MARCAS	VOLKSWAGEN 1.2: LUPO / POLO / EOS / FOX. SEAT 1.2: IBIZA / CORDOBA SKODA 1.2: FABIA
HERRAMIENTAS OEM	T10123 (1) (2), T10120 (3), T10121 (4)
CÓDIGOS DE MOTOR	AWY / BMD / AZQ / BME.



53275

35,50€



KIT DE CALADO GRUPO VAG

MARCAS	DODGE: CALIBER (06-11) FORD: GALAXY (02-06) MITSUBISHI: GRANDIS (05-10), LANCER (05-10), OUTLANDER (07-10). SEAT: ALHAMBRA (00-15), ALTEA/ALTEA XL (04-15), CORDOBA (02-09), IBIZA (02-15), LEON (00-13), TOLEDO (04-11). SKODA: FABIA (00-14), FABIA II (07-15), OCTAVIA (00-10), OCTAVIA II (04-15), PRACTIK (10-15), RAPID (11-15), ROOMSTER (07-15), SUPERB (02-08), SUPERB II (08-15), YETI (09-14). AUDI: A1 (10-15), A2 (00-06), A3 (01-13), A4/ALLROAD (01-16), A5 (08-15), A6 (11-14), TT (08-14), Q3 (11-15), Q5 (08-15), A6 (10-14). VOLKSWAGEN: AMAROK (10-16), BEETLE (02-15), BORA (02-08), CADDY/MAXI (03-15), EOS (06-15), FOX (05-11), GOLF (02-15), GOLF PLUS (05-14), JETTA (05-15), LUPO (02-05), PASSAT/CC (02-15), POLO (99-14), SCIROCCO (08-14), SHARAN (02-15), TIGUAN (07-15), TOURAN (03-15), TRANSPORTER (03-17).
HERRAMIENTAS OEM	DODGE: 9882, 9883. FORD: 310-085/23-059, 303-1054. MITSUBISHI: MB995206, MB995208, MB995209. VAG: T10100 (4), T10050 (1), 3359 (3/6)/T20102, T10115 (3), T10060A (2)/T40098, T20167.
CÓDIGOS DE MOTOR	1.2D TDi CR: CFWA. 1.4D TDi PD: AMF, BAY, BMS, BNM, BNV, BWB. 1.6D TDi CR: CAYA, CAYB, CAYC, CAYD, CAYE, CLNA. 1.9D TDi PD: AJM, ANU, ARL, ASZ, ATD, AUY, AVB, AVF, AVQ, AWX, AXB, AXC, AXR, BJB, BKC, BLS, BLT, BMT, BPZ, BRM, BRR, BRS, BRU, BSU, BSV, BSW, BTB, BVK, BXE, BXF, BXJ. 2.0D TDi CR/TDi PD: AZV, BDJ, BDK, BEW, BGW, BHW, BKD, BKP, BKQ, BLB, BMA, BMM, BMN, BMP, BMR, BNA, BPW, BRA, BRC, BRD, BRE, BRF, BRT, BSS, BST, BSY, BUJ, BUZ, BVA, BVE, BVF, BVG, BVH, BWC, BWV, CAAA, CAAB, CAAC, CAAD, CAE, CAG, CAGB, CAGC, CAHA, CAHB, CBAA, CBAB, CBAC, CBBA, CBBD, CBDA, CBDB, CBDC, CBEA, CCHA, CCHB, CDBA, CDCA, CEGA, CFCA, CFFA, CFFB, CFFD, CFFE, CFGB, CFGC, CFHA, CFHB, CFHC, CFHD, CFHE, CFHF, CFJA, CGLA, CGLB, CGLC, CGLD, CJAA, CJCA, CJC, CJCC, CLCA, CLCB, CLJA, CLLA, CNEA, ECD, ECD/BSY, ECD/BYL, ECE/BWD.

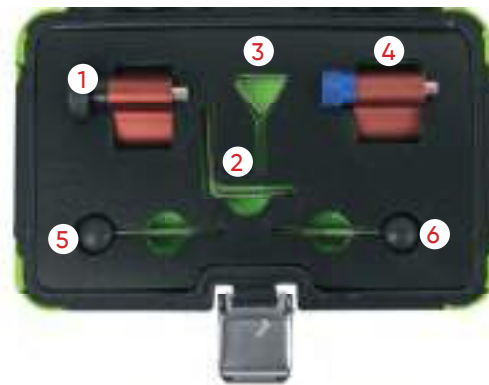

53276

160,00€

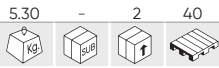

KIT DE CALADO AUDI/SKODA

MARCAS	MOTOR AUDI, VW: V6 2.0, 2.8, 3.0T FSI. AUDI QS: 2.0, A6L 2.8, 3.0T.
HERRAMIENTAS OEM	3418 (1), 3458 (2), T10100 (3), T10123 (4), T10121 (5), 3242 (6), 3551 (8), T10020 (9), T10098 (10), 3078 (12), 2064 (13), 3369 (14), T10092 (15), T40011 (17), 2065A (18), T10016 (19), 3359 (20), T10008 (21), T10050 (22) T10265 (23), T10264 (24), T10060A (25), T10120 (27), 3366 (28)
CÓDIGOS DE MOTOR	2.0, 2.8, 3.0

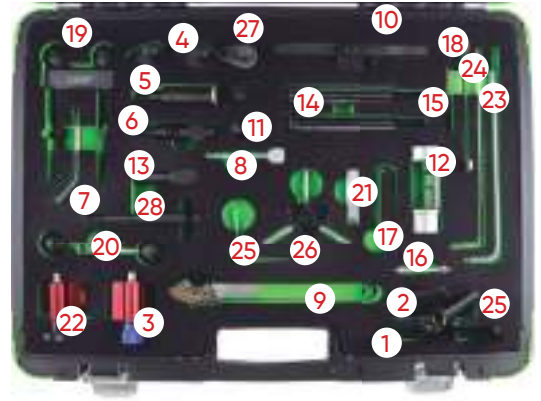

53277

45,00€

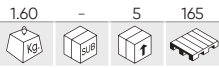

SET DE HERRAMIENTAS PARA LA CORREA DE DISTRIBUCIÓN VW/AUDI

MARCAS	GASOLINA	AUDI: 80, 100, A3, A4, A6 1.6, 1.8/TURBO, 2.0, 2.0 16V, A3, A4 1.6 (96-). SEAT: IBIZA/CORDOBA, TOLEDO, ALHAMBRA, INCA 1.6, 1.8, 1.8 16V, 2.0, 2.0 16V, IBIZA/ CORDOBA, LEON, TOLEDO 1.6 (99-), ALHAMBRA 2.0 (00-). VOLKSWAGEN: POLO CLASSIC, SCIROCCO, CORRADO, GOLF, JETTA, VENTO, PASSAT, SHARAN, TRANSPORTER 1.6, 1.8/TURBO, 1.8 16V, 2.0, 2.0 16V, POLO CLASSIC, GOLF, BORA, BEETLE 1.6 (97-), 2.0 (99-). SKODA: OCTAVIA 1.6 (97-), 2.0 (99-).
	DIESEL	AUDI: 80, 100, A3, A4, A6 1.9 TURBO D, 1.9TDI, 2.5TDI, A3, A4, A6 2.0TDI, A2, A3, A4, A6 1.2TDI, 1.4TDI, 1.9TDI (99-). SEAT: IBIZA/CORDOBA, LEON, TOLEDO, ALHAMBRA, INCA 1.7SDI, 1.9D/TD /SDI/TDI. EQRD: GALAXY (02-06). SKODA: FELICIA, OCTAVIA 1.9D/TDI. VW: POLO, POLO CLASSIC, GOLF, JETTA, VENTO, BORA, BEETLE, PASSAT, SHARAN, CADDY, TRANSPORTER 1.5D, 1.6D/ TURBO, 1.7D/SDI, 1.9SDI/TDI, GOLF, PASSAT 2.0TDI.
HERRAMIENTAS OEM	T10020 (1), 3387 (2), V159 (3), T10060/T100604 (4), T10115 (5), T40011 (6)	
CÓDIGOS DE MOTOR	2.0, 2.8, 3.0	



53278

143,00€



KIT DE CALADO AUDI 2.8, 3.2 FSI, 3.0 TFSI

MARCAS	A2, A4, A4 QUATTRO, A6 (2004-2007) A2, A3, A4, A3 FSI (2004-2007) A4, A6, A8 3.2 FSI A6 L QUATTRO 2.4 A6 2.4, A6 2.4 QUATTRO (2004-2007) A4 3.2 FSI (2004-2007) A6 3.2 FSI (2004-2007) A8 3.2 FSI (2005-2007)
HERRAMIENTAS OEM	T10172 (1), 3212 (2), T40070 (3), T40069 (4), T40071 (5), T10172/2 (6)
CÓDIGOS DE MOTOR	AUK / BDW / BDX / BKH / CAJA / CALA



53279

97,00€

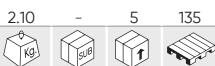

KIT DE CALADO VW/AUDI 1.8, 2.0, TSI, TFSI

MARCAS	AUDI: A3 (96-09), A4 (94-09), A6 (95-11), S3 (99-13), TT (98-14). SEAT: ALHAMBRA (97-10), ALTEA/ALTEA XL (06-09), CORDOBA (99-02), EXEO (09-10), IBIZA (99-02), LEON (99-13), TOLEDO (99-09). SKODA: OCTAVIA/OCTAVIA TOUR (98-10), OCTAVIA II (04-09). VOLKSWAGEN: BEETLE (99-11), BORA (97-04), EOS (06-10), GOLF (97-12), GOLF PLUS (05-09), JETTA (05-09), PASSAT (96-10), SCIROCCO (09-14), SHARAN (97-10), TOURAN (03-09).
HERRAMIENTAS OEM	T10020 (1), T10252 (2), T10092 (3), T10115 (4), T40011 (4), 3366 (5), T10060 (6)
CÓDIGOS DE MOTOR	1.8: ADR, AFY, AGN, AJP, APG, APT, AQE, ARG, ARH, AVV. 1.8T: AEB, AGU, AJH, AJL, AJQ, AMK, AMU, ANB, APP, APU, APX, APY, AQA, AQX, ARX, ARY, ARZ, AUM, AUG, AVC, AWC, AWLT, AWU, AYP, BAM, BFV, BVP, BVR. 2.0 TSI: AXW, BHD, BLR, BLX, BLY, BMB, BVX, BVY, BVZ. 2.0 TFSI/S/R/TSI: AXX, BPY, BWA, BGB, BPG, BPJ, BUL, BWE, BWT, BYK, BHZ, BZC, BWJ, BYD, CDLA, CDLB, CDLC, CDLD, CDLF, CDMA.



53280

112,00€



KIT ALINEACIÓN ÁRBOL DE LEVAS VW/AUDI 3.0 V6

MARCAS	AUDI: A4 (01-08), A6 (01-08), A8 (03-10).
HERRAMIENTAS OEM	3387 (1), T40030 (2) (4), T40026 (3), T40028 (5)
CÓDIGOS DE MOTOR	3.0 V6 30V: ASN, AVK, BBJ, BGN.

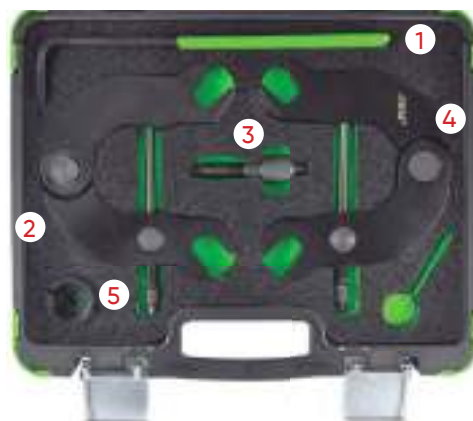

53281

55,00€



KIT ALINEACIÓN ÁRBOL DE LEVAS VW/AUDI

MARCAS	VOLKSWAGEN: 2.5 TDi V6 AUDI: A4, A6, A8
HERRAMIENTAS OEM	3369 (1), 3242 (2), 3458 (3)
CÓDIGOS DE MOTOR	AFB/AKN



53282

48,00€

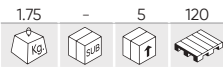

KIT DE CALADO GRUPO VAG 1.2, 1.4, 1.6

MARCAS	SEAT: ALHAMBRA (10-15), ALTEA/ALTEA XL (08-15), IBIZA/CORDOBA (08-12), LEON (07-13), TOLEDO (07-15). VOLKSWAGEN: BEETLE (11-15), CADDY/CADDY MAXI (10-15), EOS (06-12), GOLF (03-12), GOLF PLUS (03-14), GOLF V ESTATE (07-13), GOLF VI CABRIOLET (10-15), JETTA (06-14), PASSAT (05-11), POLO (02-14), SCIROCCO (08-12), TIGUAN (07-12), TOURAN (03-15). SKODA: FABIA II (07-15), OCTAVIA II (04-15), PRAKTIK (10-15), RAPID (12-15), ROOMSTER (06-15), SUPERB II (09-14), YETI (09-14). AUDI: A1 (10-15), A3 (03-13).
HERRAMIENTAS OEM	T10171 (1), T10170 (2), T40011 (3)
CÓDIGOS DE MOTOR	1.2 TFSI: CBZA, CBZB, CBZC. 1.4 FSI: AXU, BKG, BLN. 1.4 TFSI: BLG, BMY, BWK, CAVA, CAVB, CAVC, CAVD, CAVE, CAVF, CAXA, CAXC, CDGA, CSMA. 1.6 FSI: BAG, BLF, BLP, BTS.



53283

92,00€



KIT DE CALADO GRUPO VAG 2.7, 3.0 TDI

MARCAS	VOLKSWAGEN: TOUAREG, PHATEON VAG: DIESEL 2.7 / 3.0 V6 AUDI: A4, A5, A6
HERRAMIENTAS OEM	3242 (1), T40060 (2) (3), 3359 (4), T40058 (5), T40061 (6), T40062 (7), T40049 (8)
CÓDIGOS DE MOTOR	ASB, BKN, BKS, BWZ, BNG, BPP, BSG, BUG, BUN, CAWA, CAMB, CANA, CANB, CANC, CAND, CAPA, CARA, CARS, CASA, CASE, CASC, CAM, CC/HA, CCWA, CCWB, CDYA, CDVB, CDVC, CEXA, CGKA, CGKB.

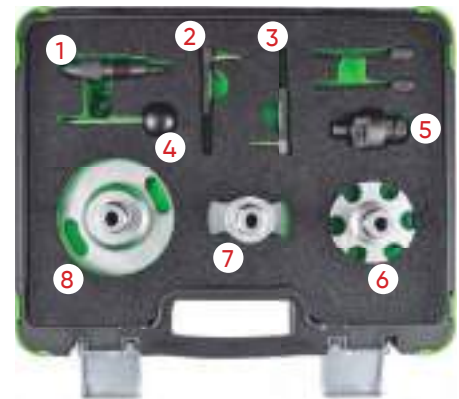

53284

306,00€



KIT DE CALADO GRUPO VAG 2.5 TDI

MARCAS	VOLKSWAGEN: TOUAREG (03-10), TRANSPORTER (03-09).
HERRAMIENTAS OEM	T10225 (1), T10199 (2), T10234 (3), T10226 (4), T10193 (5), T10194 (6), T10199/01 (7), T10226 (8)
CÓDIGOS DE MOTOR	2.5D TDI PD: AXD, AXE, BAC, BLJ, BLK, BNZ, BPC, BPD, BPE.

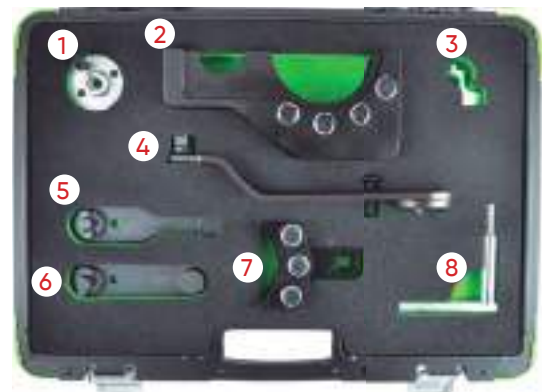

53285

56,00€



KIT DE CALADO GRUPO VAG 2.4, 2.5, SDI, TDI

MARCAS	VOLKSWAGEN: CRAFTER (06-13), LT (96-06), TRANSPORTER (90-03).
HERRAMIENTAS OEM	2065A (1), T50009 (2), T10025 (3), 3248/3419 (4), 2064 (5), 3355 (6)
CÓDIGOS DE MOTOR	2.4D: AAB, AJA. 2.5D SDI: AGX. 2.5D TDI: ACV, AHD, AHY, AJT, ANJ, APA, AUF, AVR, AXG, AXL, AYC, AYY, BBE, BBF. 2.5D TDI CR: BJJ, BJK, BJL, BJM.



53286

87,00€



KIT DE CALADO GRUPO VAG 1.8, 2.0 TSI, TFSI

MARCAS	VOLKSWAGEN: 1.8 / 2.0 TSI / TFSI.
HERRAMIENTAS OEM	T10368 (2), T10354 (3), T40271 (1)(4), T10352/2 (5), T10352/1 (6), T10352 (7), T40196 (8) (9) (10) (11), T40267 (12) (13), T40098 (14), T10060A (15), T40011 (15)
CÓDIGOS DE MOTOR	BYT, BZB, CABA, CABB, CABD, CADA, CAEA, CAEB, CAWA, CAWB, CBFA, CCTA, CCZA, CCZB, CCZC, CDA, CDAB, CDHA, CDHB, CDNB, CDNC, CDND, CESA, CETA, CFKA, CGYA, CJEB, CJBA, CJSB.



53287

245,00€



KIT DE CALADO VW/AUDI 1.8, 2.0 TURBO

MARCAS	VOLKSWAGEN AUDI	1.8 / 2.0 TURBO
HERRAMIENTAS OEM	T10355 (1), T40196 (2), T40271 (3) (4), T10352 (5), T10352/1 (6), T10352/2 (7), T10368 (7), T40267 (8), T10354 (9), T40265 (10), T40011 (11) (14), T40098 (12), T10060A (13)	
CÓDIGOS DE MOTOR	BYT, BZB, CABB, CABD, CADA, CAEA, CAEB, CAWA, CAWB, CBFA, CCTA, CCZA, CCZB, CCZC, CDA, CDAB, CDHB, CDNB, CDNC, CDND, CESA, CETA, CFKA, CGYA, CJEB, CUSA, CJSB.	

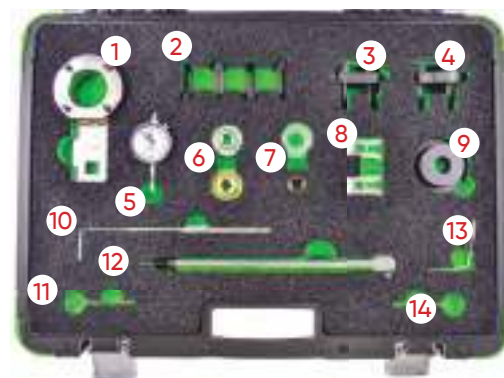

53288

72,00€

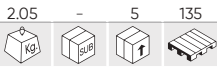

KIT DE CALADO GRUPO VAG 1.6, 2.0 TDI COMMON RAIL

MARCAS	SEAT: EXEO, LEON, ALTEA, TOLEDO, IBIZA. VOLKSWAGEN: JETTA, TOURAN, GOLF, GOLF PLUS, POLO, PASSAT, TIGUAN, SCIROCCO. SKODA: ROOMSTER, FABIA, PRAKTIK, OCTAVIA, YETI, SUPERB. AUDI: A1, A3, A4, A5, Q5, A6, TT.
HERRAMIENTAS OEM	T10264 (1), T10265 (2), T20102 (3), T10052 (4), T10051 (5), T10255 (6), T10050 (7), T10100 (8), T40098 (9)
CÓDIGOS DE MOTOR	1.2 TDI CR, 1.6 D TDI CR, 2.0 D TDI CR CAGA, CAGB, CAGC, CAHA, CAHB, CFHC, CBAA, CBAB, CFFB, CGLA, CGLB, CJCA, CJCB, CAAA, CBAA, CBAB, CBAC, CBBA, CBBB, CBDA, CBDB, CBDC, CCHA, CEGA, CJAA, CAAB, CAAC, CFJA, CFWA, CAYB, CAYC, CAYA.



53320

12,00€

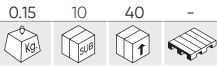

HERRAMIENTA DE BLOQUEO DEL ÁRBOL DE LEVAS GRUPO VAG

MARCAS	SEAT: ALHAMBRA, ALTEA, AROSA, CORDOBA, IBIZA, LEON, TOLEDO 1.4/1.9/2.0 TDI. VW: PASSAT 1.9. AUDI: A4/A6 1.9.
HERRAMIENTAS OEM	T10008, T20102, T10100.



53321

10,50€

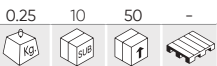

HERRAMIENTA AJUSTE TENSIÓN CORREA VAG

MARCAS	AUDI: A4/1.8T, 2.0 1999-2004 A6/1.8T 2002-2004 A4/3.0 (2002 -), A6/3.0 (2002 -), A8/7.0 (2003 -). VW: GOLF PASSAT 2.0 TDI DIESEL, GOLF 88-97, PASSAT 92-97, VW T4/2.0 1992-2004.
HERRAMIENTAS OEM	T10020



53325

7,50€

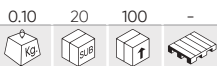

HERRAMIENTA DE SINCRONIZACIÓN DE POLEAS VW AUDI 35MM

MARCAS	AUDI: 100 ('91-), A6 (2.5 TDI) 2.3, 2.4, 2.5, 2.8, 2.9D TDI (1991-2003) VW: LT, TRANSPORTER
HERRAMIENTAS OEM	3355
CÓDIGOS DE MOTOR	AAB, AAT, ACU, ACV, AEL, AET, AGX, AHG, AHY, AJA, AJT, ANJ, APA, APL, AUF, AVT, AXG, AXL, AYC.



KITS DE CALADO (TIMING TOOLS)

53326

16,00€



KIT DE CALADO VW/AUDI

MARCAS	VW: V6 2.5TDi. AUDI: V6 2.5TDi, V8 3.3TDi.
HERRAMIENTAS OEM	3458 (1), 3242 (2)



53327

11,00€



KIT DE CALADO VAG 1.2

MARCAS	SEAT: IBIZA 1.2 6V/3CYL (2002-09), CORDOBA 1.2 12V/3CYL (2002-13). VW: POLO 1.2 6V-12V/3CYL (2002-14). SKODA: FABIA 1.2 6V-12V/3CYL (2002, 2003-), FABIA II 1.2 6V/3CYL (2007-13), ROOMSTER 1.2 12V/3CYL (2006-13), PRAKTIK 1.2 6V/3CYL (2007-13).
HERRAMIENTAS OEM	T10123
CÓDIGOS DE MOTOR	1.2 6V: AWY, BMD, BBM, CHFA, CHFB 1.2 12V: AZQ, BME, BVX, BZG, CEVA, CGPA, CGPB, CGPC.



53648

107,00€



KIT DE CALADO DE DISTRIBUCIÓN VAG 1.0, 1.2, 1.4 TSI

MARCAS	AUDI: A1 (12-15), A1 SPORTBACK (12-15), A3 (13-15), A3 SPORTBACK (12-15). SEAT: IBIZA (12-15), LEON (12-15), TOLEDO (12-15). SKODA: FABIA (10-13), OCTAVIA II (10-13), OCTAVIA III (10-15).
HERRAMIENTAS OEM	T10060A (1), T10340 (2), T10476 (3), T10494 (4), T10499 (5), T10504/1 (6), T10504 (7), T10504/2 (8).
CÓDIGOS DE MOTOR	1.2 TSI: CJZA, CJZB. 1.4 TSI: CGGA, CHPA, CMBA, CPVA, CRJA, CXSA. 1.4 TSI ACT: CPTA.

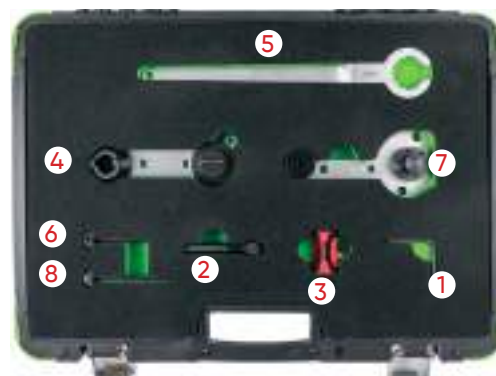

53649

89,00€

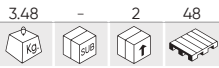

KIT DE CALADO GRUPO VAG

MARCAS	AUDI SEAT	SKODA VW
HERRAMIENTAS OEM	T10340 (1), T10476 (2), T10477 (3), T10487 (4), T10494 (5), T10499 (6)	
CÓDIGOS DE MOTOR	1.0 MPI: CHYA. 1.0 TSI: CHZE, CHZC, CHZA, CHZB, CHZC, CHZD, CHZJ. 1.2 TSI: CJZB, CJZC, CYVA, CJZA, CJZD, CYVB. 1.4 TSI: CZCC, CMBA, CZCA, CHPA, CPTA (ACT), CZDA, CVNA, CZEA (ACT).	

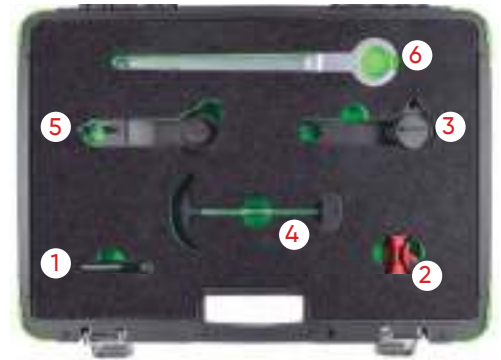

53706

98,00€

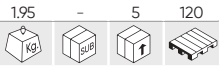

KIT ALINEACIÓN ÁRBOL DE LEVAS VAG 1.4, 1.6, 2.0 TDI COMMON RAIL

MARCAS	VOLKSWAGEN: GOLF ALLTRACK, GOLF SPORTSVAN, GOLF VII, GOLF VII KOMBI, PASSAT, POLO. AUDI: A1, A1 SPORTBACK, A3, A3 CABRIOLET, A3 LIMOUSINE, A3 SPORTBACK, TT, TT ROADSTER. SEAT: IBIZA, IBIZA V SPORTCOUPE, IBIZA V ST, LEON, LEON SC, LEON ST, TOLEDO IV. SKODA: FABIA, FABIA KOMBI, OCTAVIA, OCTAVIA COMBI, RAPID, RAPID SPACEBACK.
HERRAMIENTAS OEM	OEM 3204 (1), OEM 3359 (2), OEM T10490 (3), OEM T10051 (4), OEM T10060A (5), OEM T10264 (6), OEM T10265 (7), OEM T10492 (8), OEM T40098 (9).
CÓDIGOS DE MOTOR	1.4, 1.6, 2.0 TDI CR CXXB, DBKA, DCXA, CGLE, CKFB, CKFC, CLHA, CLHB, CNHA, CNHC, CRBD, CRFA, CRFC, CRKA, CRKB, CRLB, CRLC, CRMB, CRUA, CRVA, CRVC, CSUA, CSUB, CUNA, CUPA, CUSA, CUSB, CUTA, CUUD, CXEB, DBKA, DCXA, DCZA, DFSD.

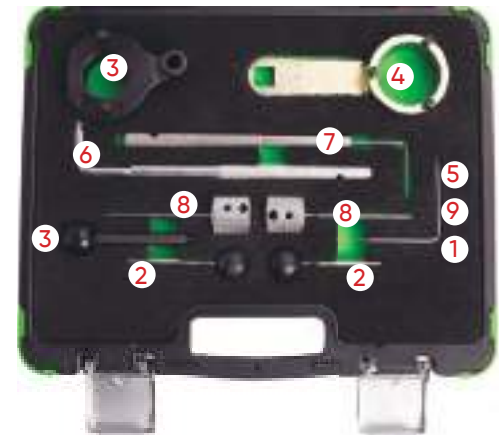

54092

24,00€

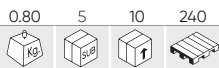

KIT DE CALADO GRUPO VAG 1.2 TFSI

MARCAS	AUDI: A1, A3, A3 SPORTBACK, A3 CABRIO SEAT: ALTEA, ALTEA XL, IBIZA, LEON, TOLEDO SKODA: FABIA II, OKTAVIA II, PRAKTIK, RAPID, RAPID SPACEBACK, ROMMSTER, YETI VW: BEETLE, CADDY, CADDY MAXI, GOLF PLUS, GOLF VI, GOLF VI CABRIO, GOLF VI ESTATA, JETTA, POLO, TOURAN
HERRAMIENTAS OEM	T10340(1), T10414(2), T10341(3)
CÓDIGOS DE MOTOR	CBZA, CBZB, CBZC



KITS DE CALADO (TIMING TOOLS)

54199

94,00€



KIT DE CALADO PARA VAG TFSI, FSI

MARCAS	AUDI: A1 (10-15), A1 SPORTBACK (10-15), A3 CABRIOLET (10-13), A3 (10-15), A3 SPORTBACK (03-13) SEAT: ALTEA/ALTEA XL (10-15), IBIZA (10-15), LEON (10-13), TOLEDO (12-15) SKODA: FABIA II (10-15), PRAKTIK (10-15), RAPID (12-15), RAPID SPORTBACK (12-15), OCTAVIA II (04-13), YETI (09-15), YETI OUT-DOOR (13-15) VW: BEETLE (11-15), CADDY/CADDY MAXI (10-15), EOS (07-15), GOLF V (03-13), GOLF V ESTATE (07-09), GOLF VI (10-13), GOLF VI ESTATE (10-13), GOLF VI CABRIOLET (11-15), GOLF PLUS (05-14), JETTA (05-14), PASSAT (05-15), POLO (09-14), SCIROCCO (08-14), TIGUAN (07-15), TOURAN (03-15)
HERRAMIENTAS OEM	T10414 (1), VAS 6079 (2), T10170 (3), T10171/ T10171A (4), T40011 (5), T10340 (6), T10341 (7)
CÓDIGOS DE MOTOR	1.2 TFSI: CBZA, CBZB, CBZC 1.4 FSI/TFSI: BLG, BMY, BWK, CAVA, CAVB, CAVC, CAVD, CAVE, CAVF, CAXA, CAXC, CDGA, CSMA 1.6 FSI: BAG, BLF, BLP



54218

142,00€



KIT DE HERRAMIENTAS PARA AMORTIGUADOR DE VIBRACIONES GRUPO VAG

MARCAS	AUDI, SEAT, SKODA, VOLKSWAGEN
HERRAMIENTAS OEM	T10531/1 (1), T10531/2 (2), T10531/3 (3), T10531/4 (4)
CÓDIGOS DE MOTOR	1.8L TFSI: BZB, CDAA, BPU, BYT, CABA, CABB, CDHA, CDHB, CABD, DAJB, CJSB, CJSB, CJEB, CJEE, CJED, CYGA, CDAC, CJSC, CGYA, DAJA 2.0L TFSI: CAWB, CCZA, CBFA, CCTA, CDNB, CDNC, CDND, CJXA, CJXE, CJXH, CHHB, CHHA, CULA, CFKA, DEDA, CHJA, CAWA, CCZC, CCZD, CPSA, CJK, CJKB, CESA, CETA, CFPA, CNCD, CPLA, CYRB, CYRC; CNCE, CYNB, CYP, CULB, CULC, CNCB, CWZA, CJXF, CJXC, CJXB, CJXG, CHHC, CCZB



54407

397,00€



JUEGO DE HERRAMIENTAS DE MONTAJE DE ÁRBOL DE LEVAS PARA VAG/PORSCHE

MARCAS	AUDI, PORSCHE, SEAT, SKODA, VOLKSWAGEN 1.2 - 1.6 - 2.0 - 2.7 - 3.0 - 4.0 - 4.2 COMMON RAIL
HERRAMIENTAS OEM	T40094, T40094/1 (1), T40094/2 (2), T40094/3 (3), T40094/4 (4), T40094/5 (5), T40094/6 (6), T40094/7 (7), T40094/8 (8), T40094/9 (9), T40094/10 (10), T40094/11 (11), T40094/12 (12), T40095 (13), T40096 (14), T40096/1 (15)
CÓDIGOS DE MOTOR	ASB, ASE, BKN, BKS, BMK, BNG, BPP, BSG, BTR, BUG, BUN, BVN, CAAA, CAAB, CAAC, CAAD, CAAE, CAGA, CAGB, CAGC, CAHA, CAHB, CAMA, CAMB, CANA, CANB, CANC, CAND, CAPA, CARA, CASA, CASB, CASC, CASD, CATA, CAYA, CAYB, CAYC, CAYD, CAYE, CBAA, CBAB, CBAC, CBBA, CBBB, CBDA, CBDB, CBDC, CCFA, CCFC, CCHA, CCHB, CCLA, CCMA, CCWA, CCWB, CDBA, CDCA, CDSB, CDTA, CDTB, CDUC, CDUD, CDYA, CDYB, CDYC, CEGA, CEXA, CFCA, CFFA, CFFB, CFFD, CFFE, CFGB, CFGC, CFGD, CFHA, CFHB, CFHC, CFHD, CFHE, CFHF, CFJA, CFWA, CGKA, CGKB, CGLA, CGLB, CGLC, CGLD, CGLE, CGQB, CJAA, CJCA, CJCB, CJCC, CJCD, CJGA, CJGC, CJGD, CJMA, CKDA, CKTB, CKTC, CKUB, CKUC, CKVB, CKVC, CLAA, CLAB, CLCA, CLCB, CLJA, CLLA, CLNA, CLZB, CMEA, CMFA, CMFB, CMGB, CMHA, CNEA, CNFA, CNRB, CRCA, CSHA, M05/9D(CAS), M05/9E, M05/9E(CRCA), M05/9E(CRCB)

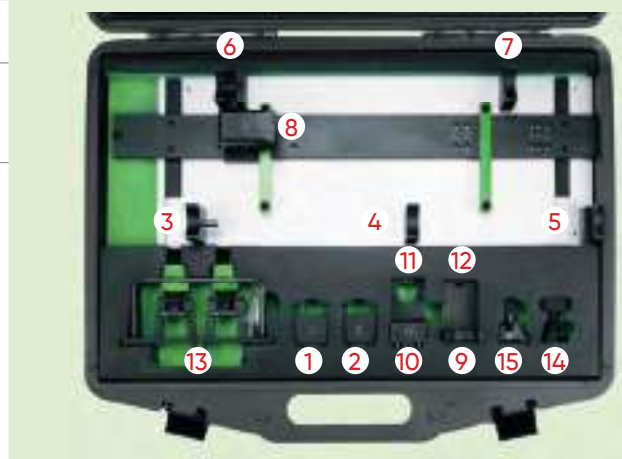

54408

46,00€

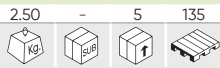

N

KIT DE CALADO VAG DIESEL 1.7, 1.9, SDI, TDI

MARCAS	AUDI: A3, A4, A6, CABRIOLET, SEAT: ALHAMBRA, AROSA, CORDOBA, IBIZA, INCA, LEON, TOLEDO, SKODA: FELICIA, OCTAVIA VW: BORA, CADDY, FOX, GOLF, LT, LUPO, PASSAT, POLO, SHARAN, TRANSPORTER, VENTO
HERRAMIENTAS OEM	T1020 (1), 2587 (2), 2065A (3), T20044 (4), T10098 (5), T40011 (6), 2064 (7), T3359 (8), T10092 (9), M5x60M (10)
CÓDIGOS DE MOTOR	1.7TDi/SDi: AHB, AHG, AKU, AKW 1.9TDi/SDi: 1X, 1Y, 1Z, ABL, AAZ, AEF, AEY, AFF, AFN, AGD, AHF, AHH, AHU, AGP, AGR, ALE, ALH, AQM, ASV, ASY, ASX, AVG, AYQ 2.4D: 1G, 1S, DW, DV, ACL, ACT

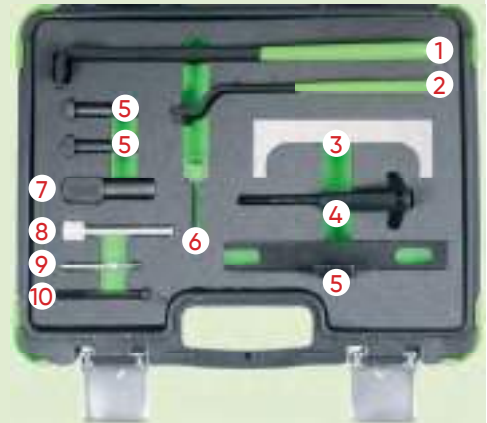

54409

32,00€

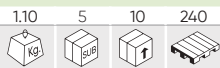

N

KIT DE CALADO VAG 1.4 TSI

MARCAS	ATECA (2016-) A3 (2012-) SUPERB (2015-) A1 SPORTBACK (2012-2018) LEON/LEON ST (2012-2020) MK5 (2012-2018) Q2 (2016-) Q3 (2015-2018)
HERRAMIENTAS OEM	T10340 (1) T10504 (2) T10504/1 (3) T10504/2 (4)
CÓDIGOS DE MOTOR	1.4 TFSI (CoD)-CPTA, CZEA 1.4 TSI (ACT)-CPTA, CZEA



54410

33,50€



N

KIT DE CALADO VAG 2.4, 3.2 FSI

MARCAS	AUDI: A4, A5, A6, A7, A8, Q5, Q7, R8, RS4, RS5, RS6, S4, S5, S6, S8 VW: TOUAREG
HERRAMIENTAS OEM	T40058 (1) T40069 (2) T40071 (3) T40133 (3) T40133/1 (3) T40133/1/2 (3) T40133/2 (3) 40071 (4)
CÓDIGOS DE MOTOR	2.4: BDW 3.2: AUK, BKH, BPK 4.2: BAR, BNS, BVJ, CAUA, CDRA, CFSA, BYH, CNDA 5.0: BUH 5.2: BSM, BUJ, BXA, CMPA, CTPA, CTYA

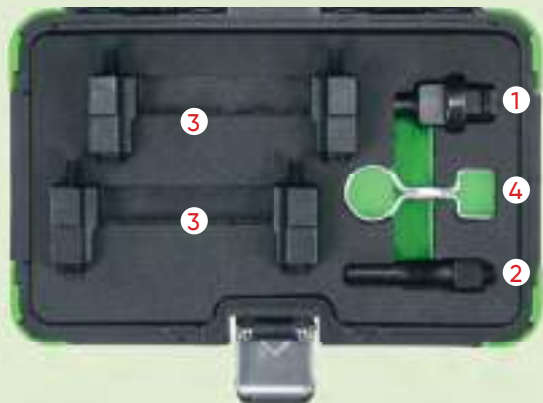

KITS DE CALADO (TIMING TOOLS)

54411

36,00€



N

KIT DE CALADO VAG/PORSCHE 2.4, 2.8, 3.0 TFSI

MARCAS	AUDI: A4 (2011-2015) A5 (2007-2017) A6 (2007-2018) A7 (2010-2018) A8 (2010-2018) A8 (2010-2018) Q7 (2010-2018) S4 (2009-2017) S5 (2010-2017) S5 (2010-2017) Q5 (2008-2017) SQ5 (2013-2018) PORSCHE: CAYENNE (2010-2014) PANAMERA 2011-2013 VAG: TOUAREG (2010-2014)
HERRAMIENTAS OEM	T40133/1 (1) T40133/2 (2) T40058 (3) T40069 (4) T40071 (5)
CÓDIGOS DE MOTOR	AUDI: 2,5 CLXB, CPAA 2,8 BDX, CCDA, CCEA, CHVA, CJBA, CNYA 3,0 CAJA, CAKA, CCAA, CGEA, CGWA, CGWB, CGWC, CGWD, CGXB, CGXC, CHMA, CHMB, CJTB, CJTC, CJWC, CMDA, CMUA, CNA, CREA, CREC, CRED, CTTA, CTUA, CTUD, CTVA, CTWA, CTXA 3,2 CALA, CALB PORSCHE: 3,0 M06/EC VAG: 3,0 CJTA, CGFA



54412

57,00€



N

KIT DE CALADO AUDI 2.5 TFSI

MARCAS	AUDI: RSQ3 (2013-2015), RSQ3 (2015-2018), RS3 (2010-2013), RS3 (2015-2017), TT (2009,2014)
HERRAMIENTAS OEM	T03003 (1) T40264/1/2 (2), T40264/2A (2) T40069 (3) T40011 (4) T40297 (5)
CÓDIGOS DE MOTOR	2,5 TFSI/RS CEPA, CEPB, CTSA, CZGA, CZGB



54413

115,00€



N

KIT DE CALADO AUDI 4.0 FSI, TFSI

MARCAS	AUDI: A8, RS6, RS7, S6, S7, S8 (2012-2018)
HERRAMIENTAS OEM	T40071 (1) T40257 (2) T40264/1 (3) T40264/2 (4) T40264/3 (5) T40269 (6) T40272 (7)
CÓDIGOS DE MOTOR	CEUA CEUC CGTA CRDB CTFA CTGA CTGE CWUB CWUC DDTA

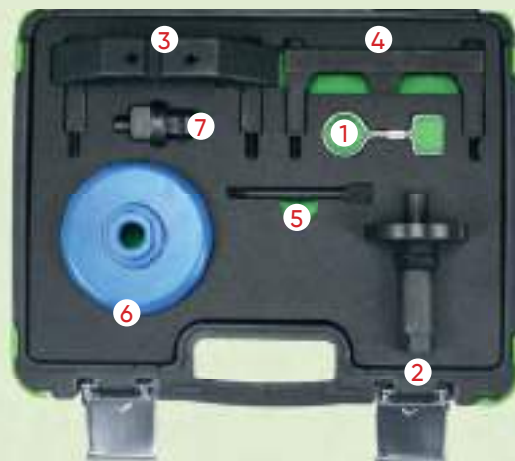

54431

184,00€



N

KIT DE CALADO ALFA ROMEO/MASERATI 2.9

MARCAS	ALFA ROMEO: GIULIA, STELVIO MASERATI: 3,8T
HERRAMIENTAS OEM	1860815000 (1) 2024000090 (2) 2024100000 (3)
CÓDIGOS DE MOTOR	2.9: 670050436,670051007 ,670052721 ,670052722



53315

285,00€

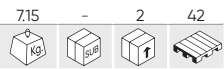

KIT DE CALADO VOLVO 3.0, 3.2T6 / LAND ROVER 3.2

MARCAS	VOLVO: S60 (10-16), S80 (07-15), XC60 (08-15), XC70 (06-15), XC90 (10-14), V60 (10-15), V70 (10-15). LAND ROVER: FREELANDER II (11-14).
HERRAMIENTAS OEM	VOLVO: 999-7263 (3), 999-7264 (1), 999-7272 (5), 999-7257 (2), 999-7261 (4). LAND ROVER: 303-1225 (3), 303-1226 (1), 303-1219 (2), 303-1223 (4).
CÓDIGOS DE MOTOR	3.0 TURBO: B6304T2, B6304T4. 3.2: B6324S, B6324S5. 3.2i6: B6324S.

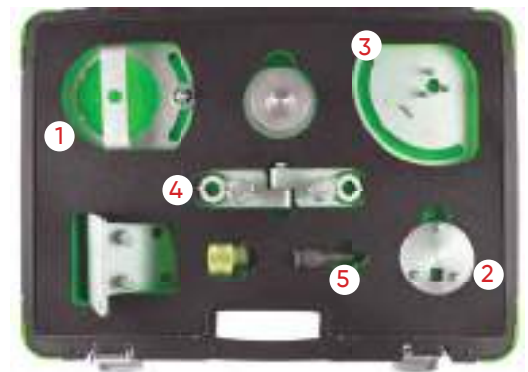

54226

71,00€



SET EXTRACTOR PARA POLEA DE LA BOMBA DE ALTA PRESIÓN PARA HYUNDAI/KIA

MARCAS	HYUNDAI: ACCENT (11-15), ELANTRA (07-10), I20 (09-18), I20 (10-18), I20 COUPE (15-17), I30 (07-19), IX35 (10-16), I40 (11-18) KIA: CARENS (13-18), CEED (07-18), OPTIMA (11-15), PRO-CEED (08-19), RIO (09-17), CERATO (05-07), SOUL (09-14), SPORTAGE (10-18), VENGA (09-18)
HERRAMIENTAS OEM	09331-2A000/2A010 (1), 09331-2A010 (1)
CÓDIGOS DE MOTOR	1.1D CRDI: D3FF 1.4D CRDI: D4FC(U1), D4FC(U2) 1.6D CRDI: D4FB(U1), D4FB(U2), D4FB-H(U1), D4FB-H(U2), D4FB-L(U1) 1.7D CRDI: D4FD(U2), D4FD-H(U2), D4FD-L, D4FD-L(U2)



KITS DE CALADO (TIMING TOOLS)

54200

56,00€



KIT DE CALADO PARA PORSCHE

MARCAS	911 (2001 - 2008), BOXSTER (2002 - 2011), CAYMAN (2006 - 2009)
HERRAMIENTAS OEM	9685 (1), 9686 (2), 9595 (3), 9595/1 (4)
CÓDIGOS DE MOTOR	M96/03, M96/05, M96/23, M96/25, M97/20, M96/24, M96/26, M97/01, M97/21, M97/22.



51927

25,00€



HERRAMIENTAS PARA LA INSTALACIÓN Y EXTRACCIÓN DE CORREA AUXILIAR



51340

39,30€



LLAVE UNIVERSAL PARA ÁRBOL DE LEVAS + ADAPTADORES



52616

44,00€

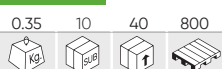

TENSIÓMETRO PARA CORREAS DE DISTRIBUCIÓN

- Dos escalas graduables (daN) con lectura frontal y posterior.



53769

178,00€

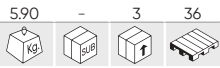

KIT DE CALADO PARA RENAULT/NISSAN/OPEL/VOLVO

MARCAS	<p>RENAULT: AVANTIME, CLIO, ESPACE, KANGOO, LAGUNA, MASTER, MEGANE, MODUS, SCENIC, TWINGO, TRAFFIC. OPEL/VAUXHALL: MOVANO, VIVARO. DACIA: DOKKER, DUSTER, LOGAN, SANDERO. NISSAN: ALMERA, INTERSTAR, KUBISTAR, MICRA, NOTE, PRIMERA, QASHGAI. VOLVO: S40, V40</p>
HERRAMIENTAS OEM	<p>MOT 1312 (1), MOT 1135-01 (2), MOT 1384 (3), MOT 1340 (4), MOT 1543 / KM-6234 / KV113 B0360 (5), MOT 1489 / KV113 B0130 (6), MOT 1536 / KM-6203 (7), MOT 1489 (8), MOT 1054 / KM-6031 / KV113 / B0280 (10), MOT 1318 (11), MOT 910 (12), MOT 910 (14), MOT 1386 (15), MOT 1534 / KM-6205 (16), MOT 1543 / KM-6234 / KV113 B0360 (17), MOT 1543 / KM-6234 / KV113 B0360 (18), MOT 1543 / KM-6234 / KV113 B0360 (19), MOT 1543 / KM-6234 / KV113 B0360 (20), MOT 1386 (22), MOT 1537 / KM-6204 (23), MOT 1348 (24), MOT 1538 (25), MOT 1337 (26), MOT 1496 / MOT 1750 (27), MOT 1490-01 (28), MOT 1200-01 (29)</p>
CÓDIGOS DE MOTOR	<p>PEROL: 2.0 16V, 2.5 20V, 1.4, 1.6 16V, 1.8, 2.0 16V, 1.2, 1.7, 1.8, 2.0 16V, 2.2 GASOIL: 1.9, 2.5, 2.8</p> <p>D4F702/706/708/712/714/716/722/728/730/740/764, D7F700/701/710/720/722/726/730/744/746/764/766, E7F700/704/706/750, E7J601/624/626/634/635/680/700/706/710/711/716/718/719/720/724/726/728/740/742/745/754/756/757/764/770/771/773/780, F3P670/682/700/704/706/708/710/712/714/720/724/755/758/760, F7P704/722, F3R611/722/723/728/729/750/751/752/791/796/797/798, F5R700/701/740, J7R732/733/734/735/768, F7R710/714, J7T600/760/761/762/766/772/780/782, N7Q704/710/711, N7U700/701, K4J700/710/711/712/713/714/715/730/732/740/750/770/780, K4M700/701/704/706/707/708/709/710/711/712/714/716/718/720/724/730/732/734/736/740/742/743/744/745/746/748/750/752/753/754/760/761/762/764/765/766/768/776/782/788/790/791/794/800/801/802/804/812/813/830, K9K700/702/704/706/710/712/714/716/718/722/724/728/729/732/734/740/750/752/760/762/764/766/768/802/804/806, F9Q610/650/664/670/674/71/716/717/718/720/722/730/731/732/733/734/736/738/740/744/748/750/752/754/758/759/760/768/762/770/772/774/780/782/784/786/788/790/796/800/803/804/808/812/816/818/820, G9T600/605/700/702/703/706/707/710/712/720/722/742/743/750, G9U720/724/726/730/750/754, F8M736/760, F8Q600/610/606/620/622/624/630/632/640/644/646/648/662/672/678/680/682/684/692/696/706/714/720/722/730/732/740/742/744/764/768/706/776/784/786/788, J8S620/621/622/758/760/776/778, G8T714/716/740/752/760/790/792/794, S8U720/722/730/731/742/748/750/752/770/772/780/782, S9U700/702/704/714/740, S9W700/702/206/208/212, E5F, E6J, K7M, F4P/F4R, FIN, F2N, F3N, F2R, F3P, F4P, F3R, J5T, J6R, J7R</p>

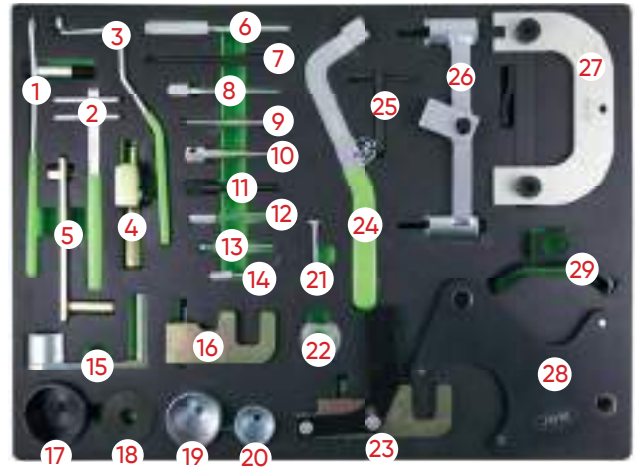

53773

298,00€

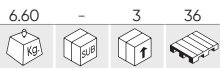

KIT DE CALADO PARA FIAT/ ALFA/LANCIA/OPEL/SUZUKI/FORD

MARCAS	<p>ALFA: ROMEO 145, 146, 147, 155, 156, 159, 166, SPIDER, GTV, TS, GT, CROSSWAGON Q4 FIAT: PUNTO, GRANDE PUNTO, BRAVA, BRAVO, MAREA, WEEKEND, STILO, DOBLO, CARGO, IDEA, PANDA, MULTIPLA, PALIO, STILO, 500 LANCIA: LYBRA, YPSILON, THESIS, MUSA OPEL: CORSA, AGILA, MERIVA, COMBO, VECTRA, ZARA, ASTRA, INSIGNA, SIGNUM 19 CDTI SUZUKI: IGNIS, SWIFT, WAGON R+ FORD: KA</p>
HERRAMIENTAS OEM	<p>1860874000 (1), 1860874000 (2), 2000004400 / 2190754400 (3), 1860863000 (4), 1860898000 (5), 2190754500 (6), 2000004300 (7), 1870900400 (8), 1860703000 (9), 1860933000 (10), 1860845000 (11), 1870900300 (12), 1860905000 / EN-46788 (13), 1895443000 (14), 1860992000 (15), 1870896900 (16), 1860987000 (17), 1860905000 (18), 1860771000 (19), 1860161000 (20), 1860876000 (21), 1860876000 (22), 1871000900 (23), 1860985000 (24), 2000004200 / 2190754200 (25), 1860965000 (29)</p>
CÓDIGOS DE MOTOR	<p>176B9.000, 182B2.000, 188A5.000, 843A1.000,323.02, 371.01, 182B4.000, 182B9.000, 186A6.000, 188A2.000, 188A7.000, 188B2.000, 192A1.000, 192A3.000, 937A2.000, 939A1.000, 192A5.000, 192B1.000, 198A5.000, 937A5.000, 939A2.000, 325.01, 342.02, 362.02, 185A6.000, 841C.000, 841G.000, 939A3.000, 940A3.000, 940A4.000, 940A5.000, Z19DT/DTH/DTR/DTL/DTL, 169A1.000, 955A4.000, 350A3.000, 192B4.000, 198A2.000, 350A2.000, 955A3.000, 192A8.000, 198A6.000, 198A3.000, 199B1.000, 199B2.000, 199A2.000, 199A3.000, 199A9.000, 188A3.000, 188A8.000, 188A9.000, 192A9.000, 186A8.000, 186A9.000, 199A5.000, 223A7.000, 223A9.000, 841H.000, 841P.000, 185A2.000, Z13DT, Z13DTJ, Z13DTH, 182A4.000, 182A6.000, 182B6.000, 178B3.000, 186A3.000, 186A4.000, 350A1.000, 169A4.000, 188A4.000, 199A4.000, 199A7.000</p>



53770

198,00€



KIT DE CALADO PARA FORD/SEAT/VOLKSWAGEN/MAZDA/VOLVO

MARCAS	FORD: FIESTA, FUSION, COURIER, ESCORT, FOCUS, FOCUS C MAX, PUMA, MONDEO, SIERRA, COUGAR, GALAXY, C-MAX, ORION, TOURNEO CONNECT, TRANSIT, TRANSIT CONNECT. VW: SHARAN. SEAT: ALHAMBRA. MAZDA: 121. VOLVO: S40, V50.
HERRAMIENTAS OEM	303-1061 (1), 303-1054 (2), 23-059 / 310-085 (3), 21-105 (4), 323-029 (6), 0194-B / 21-263 / 303-735 / 49 JE 02 021 (7), 0132-AB / 0178-D / 21-151 (9), 0194-C, 21-262, 303-734, 49 JE 02 020 (10), 21-238 / 303-679A / 303-1151 (11), 21-238 / 303-679A / 303-1151 (12), 303-1054 (13), 303-1151 (14), 21-238 / 303-679A (15), 303-393 / 303-393-02 (16), 303-1097 (17), 21-168 / 303-393 (18), 303-0985 (20), 2064 / 23-047 / 310-055 / U20003 (21), 303-652 (22), 21-229, 303-651 (23), 303-748 (24), 21-210 (25), 21-260, 303-732 (26), 21-163, 303-620 (27), 21-234 / 21-251 (28), 303-675 / 303-698 (29), 21-104 / 303-193 (30) / 21-162B / 303-367 / 303-376 (31), 21-162B / 303-376 / 303-376B (32), 23-019 (33), 23-058 / 310-084 (34), 0153-M / 0178-C / 0178-D (35), 0178-B / 5711-TB (36), 21-123 (37), 23-020 (38), 21-234 / 21-251 (39), 303-1059 (40), 23-019 (41), 303-1060 (42), 303-393 / 303-393-01 (43)
CÓDIGOS DE MOTOR	FUJA, FUJB, FXJA, FXJB, FYJA, FYJB, F8JA, F8JB, M7JA, M7JB, DHA, DHB, DHC, DHD, DHE, DHF, DHG, FHA, FHE, LIT, LIV, LIE, LIG, LIH, LIK, RDA, RDB, RKC, RQB, RQC, FXDA/C, FXDB/D, FYDA/C, FYDB/D, FYDH, HWDA1Z, AHU, AVG, AFN, D24, D24T, D24TIC, RFN, RTJ, RTK, RVA, RFK, RKD, B4164S3, DV4TD (8HW/8HX/8HZ), DV4TED4(8HV/8HY), DV6ATED4 (9HX/9HY/9HZ) F6JA, F6JB, F6JC, G8DA, G8DB, KKDA, SNJA, SNJB, STJA, STJB, ASDA, ASDB, FXJC, SPJA, SPJC, FYJC, HWDA, HWDB, SHDA, SHDB, SHDC, JQDA, LQDB, JTDA, JTDB, HXDA, HXJA, HXJB, IQDA/B, IQDB, PNBA, PNDA, RHBA, SIDA, F6JD, TZJA, TZJB, HHDA, HHDB, HHJA, HHJC, HHJD, HHJE, HHJF, RTA, RTB, RTC, RTD, RTE, RTF, RTH, RTJ, RTK, RFN, BHPA, HCPA, HCPB, KKDA, P7PA, P9PA, P9PB, R2PA, R3PA, RWPA, RWPC, F9DA/B, FFBA, FFWA, KHBA, QYBA, QYWA, KKDB, C9DC, RVA, 1Z, AFN, AHU, ANU, AUY, G6DA, G6DB, G6DC, G6DD, G6DE, G6DF, G6DG, UFDB, TXDB, TYDA, UKDB, QXBA, AZBA, KLBA, QXBB, LPBA, AZBC, TYBA, UKBA, UFBA, TXBA, IXDA, QXWA, QXWB, AZWA, KLWA, AZWC, TYWA, UKWA, TXWA, UFWA, UFDA, TXDA, UKDA, Q4BA, KNBA, 4BA, 4BB, 4BC, 4CC, 4FA, 4CA, 4CB, 4DA, 4EA, 4FA, 4FB, 4FC, 4FD, 4GA, 4HB, 4HC, 4EB, 4EC, 4ED, 4GA, 4GB, 4GC, 4GD, 4GE, 4GF, 4HA, 4HD, FMBA/B, D5BA, ABFA, D3FA, D6BA, HJBA/B, F3FA, D2FA, D4FA, F4FA, F5FA, DOFA, QJBA, QJBB, QJBC, QJBD, FXFA, H9FA, H9FB, N7BA, N7BB, MZ-CD 1.6, Y6

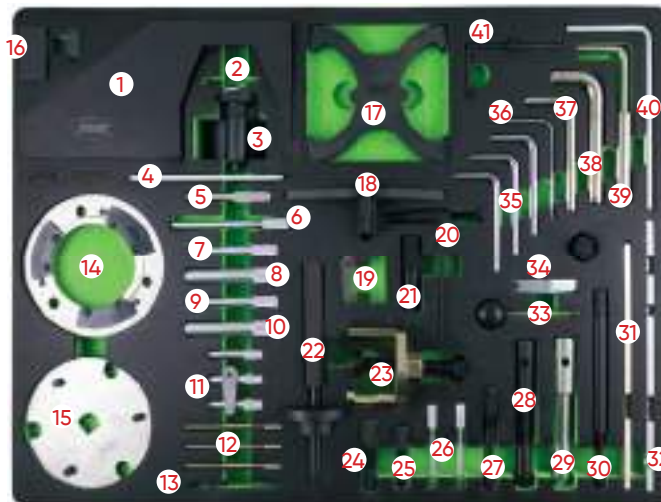

53774

190,00€



KIT DE CALADO PARA OPEL/CHEVROLET/SAAB/FIAT/LANCIA/SUZUKI/FORD

MARCAS	ALFA: 145, 146, 147, 156, 159, 166, GT, CROSSWAGON Q4 FIAT: PUNTO, GRANDE PUNTO, BRAVO, BRAVA, MAREA WEEKEND, STILO, DOBLÓ, CARGO, MULTIPLA IDEA, PANDA LANCIA: YPSILON, MUSA, LYBRA, THESIS OPEL: CORSA B/C, COMBO, TIGRA, AGILA, TIGRA B, MERIVA, ASTRA F/G/H, ASTRAVAN, SPEEDSTER VX220, ZAFIRA A/B, VECTRA B/C, SIGNUM, OMEGA B, SINTRA, FRONTERA A/B, ASTRAVAN, KADETT, ASCONA, OMEGA, MONTEREY, ANTARA, CROMA, SPEEDSTER VX220 SUZUKI: IGNIS, SWIFT, WAGON R+ FORD: KA CHEVROLET & DAEWOO: EPICA, CAPTIVA, NUBIRA, LACETTI, EVANDA SAAB: 9-3, 9-5 (98-04)
HERRAMIENTAS OEM	1860905000 / 1860905010 / EN-46788 (1), KM-6148 (2), KM-6148 (3), 1870900400 / 1871000200 (4), KM-954 (5), KM-J-43651 (6), 1860905000 / 1860905010 / EN-46788 (7), KM-852 (8), KM-853 (9), 1870900300 / 303-1468 (10), EN-46785 / KM-951 (11), KM-932 (12), 1860703000 (13), KM-955 (14), KM-6130 / KM-6349 / KM-6349 (15), KM-927 (16), EN-48245 (17), KM-933 (18), EN-46785 (19), 1860985000 / 1871000900 / EN-46781 (20), 1860985000 / 1871000900 / EN-46781 (21), EN-48246 (22), KM-929 (23), 1870896900 / EN-46789 (24), KM-952 (25), 21-162B / 303-376 / 303-376B (26), KM-933 (27)
CÓDIGOS DE MOTOR	X14XE, Z14XE, X16SEJ, X16XE, X16XEL, Y16XE, Z16XE, Z16YNG, C18XEL, X18XE, X18XE1, Z18XE, Z18XEL, C20SEL, C20XE, X20XE, Z20LEH, Z20LEL, Z20LER, Z20LET, X22SE, X22XE, Y22SE, Y22XE, Z22XE, D223L, X10XE, Z10XE, Z10XEP, X12XE, Z12XE, Z14XEP, X20DTL, X20DTH, X22DTH, Y20DTL, Y20DTH, Y22DTH, Y22DTR, 169A1.000, 955A4.000, 350A3.000, 192B4.000, 198A2.000, 350A2.000, 955A3.000, 192A8.000, 198A6.000, 198A3.000, 199B1.000, 199B2.000, 199A2.000, 199A3.000, 199A9.000, 940A3.000, 188A3.000, 939A2.000, 188B2.000, 188A8.000, 188A9.000, 323.02, 371.01, 937A2.000, 182B4.000, 182B9.000, 188A2.000, 188A7.000, 192A9.000, 186A6.000, 186A8.000, 192A1.000, 192A3.000, 192B1.000, 192A5.000, 186A9.000, 939A1.000, 199A5.000, 223A7.000, 223A9.000, 342.02, 362.02, 84TG.000, 84TH.000, 84IP.000, 939A3.000, 185A2.000, 185A6.000, Z13DT, Z13DTJ, Z13DTH, Z19DT, Z19DTH, Z19DTJ, Z19DTL, X10XE, Z10XE, Z10XEP, Z12XE, Z14XEP, X16S2R, Z16SE, 4EC1/T, 4EC1, 4EE1/T, 4EE1, X17DT, Y17DT, Y17DTI, Y17DTL, 16DA, 17D, 17DR/X, 7DTL, X17DTL, 4JX1/4, JG2T, 4FC1/T, 4FD1, X20DTL, Y20DTL, D223L Z20DMH, Z20DM, RA420, Z20S1, 194A1.000, Z22SE, Z22YH



53771

158,00€

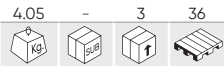

KIT DE CALADO PARA FIAT/FORD/CITROËN/PEUGEOT

MARCAS	<p>FIAT: ULYSSE, SCUDO, DUCATO LANCIA: ZETA, PHEDRA FORD: FIESTA, FUSION, FOCUS, FOCUS C-MAX CITROËN: C15, C1, C2, C3 PLURIEL, C4, C4 PICASSO, C5, C6, C8, DS3, DS4, DS5, XANTIA, XSARA, XSARA PICASSO, EVASION, BERLINGO, JUMPY, JUMPER, SAXO, ZX, XM, EVASION, AX PEUGEOT: 107, 1007, 206 CC, 207, 208, 306, 307 CC, 308, 406, 407, 508, 607, 806, 807, PARTNER, EXPERT, BOXER, 206, 106, 605, 205, 405</p>	
HERRAMIENTAS OEM	<p>4200-TH (1), 0117-AR (2), 0188-X (3), 0606-A1.A2 (4), 0188-Q2 (5), 0189-S1 (6), 7017-TR (7), 0132-P / 4507-TL (8), 0189-C (9), 0188-J1 (10), 0188-J2 (11), 0178-E (12), 0189-R (13), 0132-AK / 0188-AK / 0189-K / 0153-AK / 4533-TAD / MOT 1436 (14), 0188-AH (15), 0189-S2 (16), 0153-AB / 9041-TZ (17), 0153-M / 0178-C / 0178-D / 7014-TM / 9767-94 (18), 0189-A (19), 4527-TS1 (20), 0153-AB / 9041-TZ (21), 0189-B / 21-163 (22), 0132-AJ1 / 0153-G / 0188-M / 0189-J / 4533-TAC1 / 5711-TA (24), 0189-L (25), 0188-D / 7017-TM (26), 0132-X / 0188-Q1 / 4507-TJ / 9767-89 (27), 0194-B (28), 0132-AB / 0194-A (29), 0194-C / 21-262 / 303-734 (30), 4527-TS2 (31), 0188-E (32), 0153-A / 6012-T / 9765-54 (33), 0134-AF / 0134-Q / 0188-F / 9004-T (34), 0188-P2 / 0188-P / 174 / 7015-T (35), 0153-U 7019-T (36), 0153-N / 0188-Y / 7014-TJ / 7099-TM / 9797-34 (37)</p>	
CÓDIGOS DE MOTOR	<p>F6JA, F6JB, F6JC, G8DA, G8DB, HHDA, HHDB, HHJA, HHJB CITROËN, PEUGEOT: 1.0 / 1.1 / 1.4 / 1.6 / 1.6 16V, 1.4 / 1.6HDI / 1.8 / 1.8 16V / 2.0 / 2.0 TURBO, 1.9D / 2.0HDI / 2.2HDI / 1.8 16V / 2.0 16V TU9 (CDY/CDZ), TU1 (HDY/HDZ/HFX/HFY/HFZ), TU3 (KDX/KDY/KDZ/KFX/KFZ), TU5JP4 (NFU/NFX), TU5 (BDY/BFZ/NFT/NFV/NFW/NFY/NFZ), XU7 (LFW/LFX/LFZ), EW7J4 (RLZ), XU7JP4 (LGY), XU10 (RFL/RFU/RFW/RFX/RGX/RGY), XU10JP4 (RGX/RGY), EW10A (RFJ), EW10J4S (RFK), EW10D (RLZ), EW12J4 (3FZ), ET3JE (KFU), TU3A/JP (KFV/KFW), DV4TD (8HW/8HX/8HZ), DV4TED4 (8HV/8HY), DV6ATED4 (9HX/9HY/9HZ), EW10-CVI (RLZ), EW12 (3FZ), DW8 (WJZ/WJY), DW10 (RHY/RHV/RHZ/RHS/RHM/RHW/RHT/RHR/RHX), DW12 (4HX/4HZ/4HW/4HY), EW7J4 (6FZ), EW10J4 (RFR), EW10J4D (RLZ), DW12TED4 (4HW), DW10ATED (RHT/RHV/RHW/RHX/RHZ) FORD 1.4 / 1.6 DURATORQ TDCI</p>	

53772

229,00€

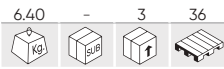

KIT DE CALADO PARA FORD/VAG/MAZDA/VOLVO

MARCAS	<p>AUDI: 80, A1, A2, A3, S3, A4, A5, A6, TT, Q5 SEAT: AROSA, IBIZA, CORDOBA, LEON, TOLEDO, ALHAMBRA, ALTEA, INCA (99-04) SKODA: FABIA, OCTAVIA, SUPERB VW: LUPO, POLO, FOX, GOLF, BORA, JETTA, GOLF PLUS, PASSAT, BEETLE, TOURAN, SHARAN, CADDY, CADDY MAXI, TRANSPORTER, GOLF VI CABRIO, TIGUAN FORD: GALAXY</p>	
HERRAMIENTAS OEM	<p>T10252 (1), VAS6079 (2), T10121 (3), MP1-1312 / T10098 / T20038 / T20038 (4), T10123 (5), 23-058 / 310-084 / T10008 (6), 2065A / T10008 / U40021 (7), 3418 (8), T10171 (9), 23-059 / 23-059 / 310-085 / T10050 / T10050 (10), 3458 / T30094 (11), T10016 / T10074 / T10074 (12), T10100 (14), T10414 (15), 3366 / T20018 / T20044 (16), 3411 (17), 3369 / T30092 (18), T10341 (19), 3242 / T40069 / T30052 (20), T 40026 (21), 3359 / MP1-301 / T20102 (22), 2064 / U20003 (23), T10120 (24), MP1-1312 / T10098 / T20038 (25), T10170 (26), T00115 / T10264 / T40098 (27), T10092 (28), T00115 / T10264 / T40098 (29), 303-1054 / T10115 (30), T10060 / T10060A (31), 3359 / MP1-301 / T20102 (32), T10340 (33), 2587 (34), 3387 / U30009A (35), 3387 / T10020 (36)</p>	
CÓDIGOS DE MOTOR	<p>ARC, ATN, AUS, AVY, AZD, AFH, BCA, AJV, AKQ, AUA, AUB, AXP, AFH, AFN, AFK, AHW, AHU, APE, AQQ, AUS, AXP, AZD, BBY, BBZ, BCB, ANY, AYZ, AMF, ATL, BAY, BHC, BMS, BNM, BNV, BWB, AJM, AMG, ANU, ARL, ASZ, ATD, ATJ, AUJ, AVB, AVF, AVQ, AWX, AXB, AXC, AXR, BEW, BJB, BKC, BKE, BLS, BLT, BMT, BPX, BRB, BRM, BRR, BRU, BSU, BSV, BTB, BUK, BVK, BXE, BXF, AZV, BDJ, BDK, BGW, BHW, BKD, BKP, BLB, BMA, BMM, BMN, BMP, BMR, BNA, BPW, BRC, BRE, BRF, BRT, BUZ, BE, BVF, BVG, BVH, BWK, BTS, BMY, BLF, BWV, AZV, BKD, AWY, AZQ (55 - 64 PF), AXU, BAG, BKG, BLF, BLN, BLP, BVF, BKF, BNU, BVP, BVR, IZ, CBZA, CBZC, CBZB, CAXA, CAGA, CAGB, CAGC, CAHA, CAYA, CAYB, CAYC, CBAA, CBAB, CBAC, CBBA, CBBB, CBDA, CBDB, CBDC, CBEA, CEGA, CKUB, AZV, BDJ, BHP, BKD, BLB, BMA, BMM, BMN, BMP, BMR, BNA, BPW, BRC, BRE, BRF, BRT, BSS, BUJ, BUZ, BVA, BVE, BVF, BVG, BVH, BWV, ACV, AFB, AGX, AHD, AHY, AHY, AJT, AKE, ANJ, APA, AUF, AXG, AXG, AXL, AYC, AYM, AYY, BAU, BBE, BBF, BCZ, BDG, BDH, BFC, BJJ, BJK, BJL, BJM</p>	

KITS DE CALADO (TIMING TOOLS)

CARRO DE HERRAMIENTAS 7 CAJONES ESPECIAL KIT DE CALADO

53951 1.794,00€

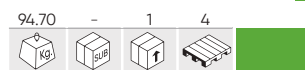

CON DOTACIÓN

53952 1.794,00€

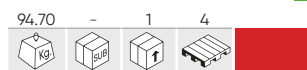

CON DOTACIÓN

54501 1.794,00€



CON DOTACIÓN

54502 1.794,00€

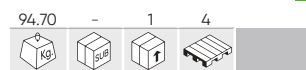

CON DOTACIÓN

MEDIDAS DEL CAJÓN

CAJONES PEQUEÑOS (X5)

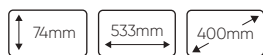

CAJONES GRANDES (X2)



CAPACIDAD DE CARGA DEL CAJÓN: 30KG.
CAPACIDAD BANDEJA SUPERIOR DE PLÁSTICO: 70KG.

MEDIDAS GENERALES DEL CARRO

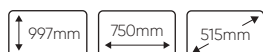

CON MÓDULOS EVA:

CONJUNTO DE 6 MÓDULOS DE KITS DE CALADO

53775 1.109,00€



GASOLINA/PETROL

DIESEL/GASOIL

CONTIENE

REF.	Kg	SUB	1	€
53769	5.90	-	3	178,00€
53770	6.15	-	3	198,00€
53771	4.05	-	3	158,00€
53772	6.40	-	3	229,00€
53773	6.60	-	3	298,00€
53774	6.95	-	3	190,00€

53769



RENAULT / NISSAN / OPEL / VOLVO

53770



FORD / SEAT / VOLKSWAGEN / MAZDA / VOLVO

53771



FIAT / FORD / CITROËN / PEUGEOT

53772



FORD / VAG / MAZDA / VOLVO

53773



FIAT / ALFA / LANCIA / OPEL / SUZUKI / FORD

53774



OPEL / CHEVROLET / SAAB / FIAT / LANCIA / SUZUKI / FORD

PARA MÁS INFORMACIÓN

PÁGINA 297

ACCESORIOS Y RECAMBIOS

PÁGINA 90

300 IVA no incluido



www.jbmcamp.com

ACCESORIOS LUBRICANTES

- 302 BOMBAS DE SUMINISTRO DE GASOIL
- 303 BOMBAS DE SUMINISTRO DE UREA
- 304 BOMBAS DE EXTRACCIÓN/LLENADO
- 307 RECOGEDORES DE ACEITE
- 308 PISTOLAS DE SUCCIÓN
- 309 CUBETOS RECOLECTORES DE ACEITE
- 310 OTROS



53697

398,00€

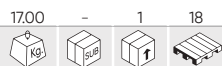

BOMBA DE SUMINISTRO DE GASOIL CON PISTOLA Y CONTADOR 200V-240V



- Voltaje: 220V±10% 50HZ.
- Potencia: 550W.
- Caudal de entrega: 20-65 l/min.
- Longitud cable: 2m.
- Longitud manguera de succión: 2m.
- Longitud manguera de suministro: 4m.

CON PARO AUTOMÁTICO



DESPIECE DISPONIBLE

53610

294,00€



BOMBA DE SUMINISTRO DE GASOIL CON PISTOLA 230V



- Longitud de la manguera de entrada: 2m.
- Longitud de la manguera de salida: 4m.
- Eléctrica.
- Se suministra con pistola y mangueras.

CON PARO AUTOMÁTICO



DESPIECE DISPONIBLE

53609

182,50€



BOMBA DE SUMINISTRO DE GASOIL CON PISTOLA 12V



- Longitud de la manguera de entrada: 2m.
- Longitud de la manguera de salida: 4m.

CON PARO AUTOMÁTICO



DESPIECE DISPONIBLE

54100

265,00€



BOMBA ELÉCTRICA PARA DIESEL



- Longitud tubo de succión: 850-1245mm
- Longitud manguera: 2m
- Temperatura de trabajo: 5° - 40°C (41° a 104°F)
- Voltaje Corriente continua: 12V
- Corriente alterna: 100-240V Longitud cable: 4m
- Capacidad de bombeo: 18.4LPM (4.86GPM)
- Viscosidad máxima del fluido: 100 CST



53645

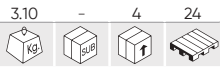

BOMBA ELÉCTRICA PARA UREA AUS32 200L



- Bomba eléctrica para bidones diseñada para medios a base de agua, Urea AUS32 y productos químicos selectos de bidones metálicos de 205L o 1000-1250L de IBCs.
- Construcción compacta y ligera.
- Fusible incorporado para protección de sobrecarga y motor silencioso.
- Filtro de acero inoxidable integrado en la entrada del tubo de succión que evita que los contaminantes entren y causen daños.



268,00€



53644

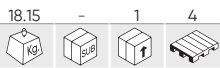

DEPÓSITO PARA UREA AUS32 75L



FABRICADO EN POLIETILENO
RESISTENTE A LOS GOLPES, A LA CORROSIÓN Y A LOS RAYOS UV

- Tanque de 75 litros móvil con una potente bomba de 12V capaz de suministrar hasta 10l/min, manguera y válvula de cierre automático.
- Las ruedas de gran diámetro (20mm) permiten maniobrar fácilmente en terrenos irregulares.



1.238,00€



15631

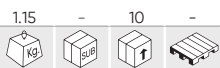

PISTOLA AUTOMÁTICA PARA SUMINISTRO UREA AUS32 (REF.53645)



98,00€

52329



BOMBA MANUAL DE EXTRACCIÓN PLÁSTICA



- Para bidones de 25, 50 y 200L.
- 350ml por bombeo.
- Cuerpo y pistón de polipropileno.
- Mango de plástico ABS.
- Aplicaciones: Alcoholes, aceites, lubricantes, gasolina, diesel, queroseno, etc.
- Conducto de succión:
 - Largo mínimo: 320mm.
 - Largo máximo: 900mm.



36,40€



13982

4,00€



ADAPTADOR ROSCA BOMBA-BIDÓN PLÁSTICO

- Permite ajustar y compensar las diferentes roscas de bidones, bombas y barriles.



52601

397,00€

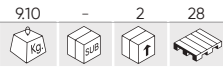

200L

BOMBA PARA BIDÓN DE ACEITE CON MANGUERA



1242mm
950mm



DESPIECE DISPONIBLE

- Presión Ratio: 5:1.
- Entrada de Aire: 1/4".
- Salida de Aire: 1/4".
- Presión trabajo: 6-8 bar.
- Presión Máx.: 8 bar.
- Consumo de Aire: 250 L/min.
- Capacidad relativa 6 bar: 18 L/min.
- Temperatura del aceite: -10~50°C.
- Viscosidad máxima: 240 SAE.
- Largo del tubo: 950mm.

50918

341,00€

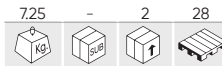

200L

BOMBA PARA BIDÓN DE ACEITE



1242mm
950mm



DESPIECE DISPONIBLE

- Presión Ratio: 5:1.
- Entrada de Aire: 1/4".
- Salida de Aire: 1/2".
- Presión trabajo: 6 - 8 bar.
- Presión Máx.: 8 bar.
- Consumo de Aire: 250 L/min.
- Capacidad relativa 6 bar: 18 L/min.
- Temperatura del aceite: -10~50°C.
- Viscosidad máxima: 240 SAE.
- Largo del tubo: 950mm.

50935

595,00€

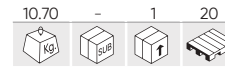

200L

KIT DE BOMBA ACEITE + MANGUERA + PISTOLA ACEITE DIGITAL



1242mm
950mm

- Largo de la manguera: 2m.
- Largo del tubo: 950mm.
- Viscosidad máxima: 240 SAE.
- Capacidad relativa 6 bar: 18 L/min.
- Consumo de aire: 250 L/min.
- Temperatura del aceite: -10~50°C.
- Presión trabajo: 6- 8 bar.
- Presión Ratio: 5:1.
- Entrada de Aire: 1/4".
- Salida de Aire: 1/2".
- Presión Máx.: 8 bar.

53566

32,00€

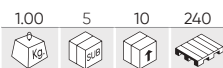

BOMBA DE ASPIRACIÓN DE ACEITE 12V



- Extractor de aceite, ideal para los cambios de aceite limpios y rápidos.
- Funciona conectando las pinzas a la batería de 12 voltios del coche.
- El aceite se sustrae del motor del vehículo a través del orificio de la varilla de medición de aceite.
- Se puede usar para extraer aceite de motor, aceite diesel o aceite de calefacción.
- Útil también para trasvases generales de los líquidos indicados.



1,2m
1,5m
Ø 6mm
Ø 12mm

51253 41,00€

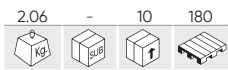

BOMBA MANUAL PARA EXTRACCIÓN DE ACEITE

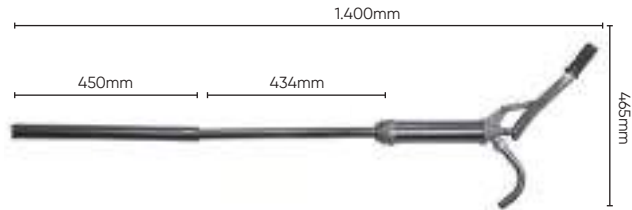

52428 40,00€

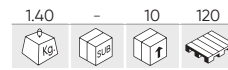

BOMBA MANUAL DE EXTRACCIÓN

- Para bidones entre 50 y 200L.
- Caudal: 400ml por impulso.
- Capacidad de bombeo: 32L x min.
- Adaptador de boca de 2" incluido.
- Tubería de succión de 101cm, con entrada de 1 1/4" y salida de 1".
- Aplicaciones: aceites, lubricantes, diésel, fluidos a base de petróleo.
- Recomendado para: líquido de freno, detergentes, glicerina, ácidos suaves, fluidos a base de petróleo.
- No permitido para: ácidos fuertes, lejías, gasolina.



50917 271,00€

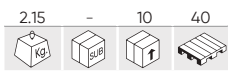

PISTOLA DE BOMBEO PARA ACEITE CON CAUDALÍMETRO DIGITAL

- Conexión: 1/2" BSPF
- Rango de caudal: 1-35 L/min
- Presión trabajo: 6-8 bar
- Rango de temperatura del aceite: -10°C~60°C
- Viscosidad máxima: 240 SAE
- Batería: 2x1.5V (pilas incluidas)
- Precisión del caudalímetro: ±0,5%.
- Repetibilidad del caudalímetro: 0,2%.
- Velocidad de descarga por revolución: 25ml/R



53627 22,50€

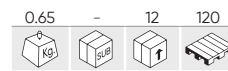

KIT EXTRACTOR DE ACEITE Y COMBUSTIBLE

- Diseñado y fabricado para extraer fácilmente aceite, combustible, y fluidos de transmisión / diferenciales de las reservas de los generadores, máquinas de lavado a presión, compresores de aire, tractores para césped y jardín, o ATV's.



REF.	DESCRIPCIÓN	Icono	€
10000	PILA PARA PISTOLA MEDIDORA DIGITAL (REF. 50917)	2.10	7,00€

52797 198,00€



BOMBA LLENADO SISTEMA TRANSMISIÓN CON 15 ADAPTADORES

- Capacidad: 7,5L.
- Descarga: 80cc ciclo.
- Rango de viscosidad: hasta SAE 140.
- Permite llenado y vaciado



12044 147,00€



SET DE 15 ADAPTADORES PARA BOMBA LLENADO SISTEMA TRANSMISIÓN PARA REF. 52797

- ATF101: FORD 1/8 - 27 (NPT).
- ATF102: Universal BMW, Honda, Nissan, etc.
- ATF103: VW/Audi. Skoda.
- ATF104: VW/Audi. Porsche.
- ATF105: VW/Audi, Mini cooper M10x1.0
- ATF106: VW/Audi DSG M24 x 1.5
- ATF107: VW/Audi CVT M22x1.5
- ATF108: Mercedes M12 x 1.5
- ATF109: V/W. Skoda M18x1.5
- ATF110: Audi/VW, Skoda M30x1.5
- ATF111: Universal flexible 300mm. Honda. Hyundai. KIA...
- ATF112: Volvo 5/16 - 24 (UNF)
- ATF113: Toyota, Lexus M18 x 1.5
- ATF114: Nissan, Infinity M8 x 1.0
- ATF115: ATF-Adapter VW Passat



REF.	DESCRIPCIÓN	Icono	€
13234	BOMBA LLENADO SISTEMA TRANSMISIÓN SIN ACCESORIOS P/52797	3.75 24	224,50€

54290

4.307,00€

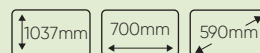

N

MÁQUINA PARA CAMBIO DE ACEITE DE TRANSMISIÓN AUTOMÁTICA



Error de intercambio equivalente
Equivalent exchange error ±100ml

- Llenado automático del líquido de transmisión
- Identificación automática del sentido de la dirección del líquido
- Limpieza automática
- Cambio automático de líquido nuevo/usado.
- Visualización de los niveles de presión de los líquidos
- Visualización precisa de la temperatura del líquido
- Control electrónico inteligente
- Base de datos actualizable
- Incluye adaptadores para diferentes marcas
- Mejora el rendimiento del sistema de transmisión automático



TUTORIAL DE USO



DESPIECE DISPONIBLE

54367

729,00€



N

JUEGO DE ADAPTADORES PARA REF.54290 (105 PCS)

CONTIENE



INFORMACIÓN TÉCNICA

54050

895,00€



MÁQUINA PARA CAMBIO DE ACEITE DE TRANSMISIÓN AUTOMÁTICA

- Fuente de alimentación: 12 V (batería de coche)
- Potencia de la bomba: 70 W
- Diámetro del manómetro de aceite: 70 mm (ambos manómetros)
- Rango del manómetro de aceite: 0-10 bar (0-150 psi) (ambos manómetros de aceite)
- Capacidad del depósito de aceite nuevo: 30 litros
- Capacidad del depósito de aceite usado: 30 litros



TUTORIAL DE USO



DESPIECE DISPONIBLE

53874

398,00€

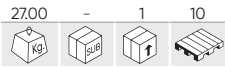

RECOGEDOR DE ACEITE 90L CON SISTEMA DE ASPIRACIÓN



PARA CAMIÓN/TURISMO

- Presión de trabajo: 8 ~ 10 bar.
- Presión de vacío: 0 ~ 0.8 bar negativo.
- Capacidad del depósito: 70L.
- Capacidad del embudo de recogida: 10L.
- Capacidad del vaso medidor: 10L.
- Velocidad de aspiración según diámetro de la varilla: 0.8L/min (Ø5x3.5mm); 1L/min (Ø6x4.5mm); 1.6 L/min (Ø8x6.5mm).
- Temperatura recomendada de trabajo del aceite: 40 ~ 60°C.
- Sistema de aspiración.
- Sistema de medición ocular.
- Depósito de gran capacidad.
- Mango para facilitar manipulación
- Ruedas para facilitar el transporte.

53873

285,00€

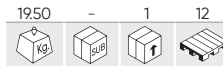

RECOGEDOR DE ACEITE 80L



PARA CAMIÓN/TURISMO

- Vaciado
- Presión de trabajo: 1-3bar
- Capacidad del depósito: 70L
- Capacidad del embudo de recogida: 10L
- Depósito de gran capacidad.
- Mango para facilitar la manipulación
- Ruedas para facilitar el transporte.
- Tipo combustible: Aceite de motor y de engranaje.

15084

68,00€

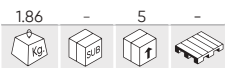

MÓDULO DE EXTRACCIÓN PARA TAPONES DE CÁRTER

	x2 5/16", 3/8"		x7 8, 9, 10, 12, 13, 14, 17mm
	x7 7, 8, 10, 11, 12, 13, 14mm		x1 T45
	x1 10mm		x1 M16
	x1 10mm		x1 200mm
			x1 150mm



53215

19,00€

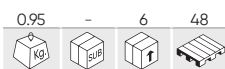

RECOGEDOR DE ANTICONGELANTE 18L



53144

18,00€



RECOGEDOR DE ACEITE 18L



ACCESORIOS LUBRICANTES

54051

39,00€

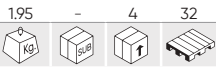

BANDEJA DE DRENAJE DE ACEITE 8L

8L PE



51356

48,00€

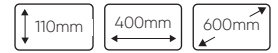
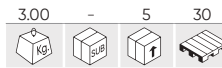

BANDEJA DE ACERO PARA LÍQUIDOS 23L

23L



52498

58,00€

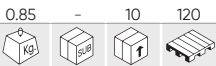

PISTOLA DE SUCCIÓN TRANSPARENTE



- Fabricada en polipropileno.
- Cuerpo transparente.
- Apta para uso con aceites de transmisión.
- Resistente a líquido de freno y anticongelantes.



52628

26,50€

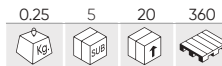

PISTOLA DE SUCCIÓN TRANSPARENTE



- Apto para uso con líquido de freno.
- Conector rápido en el extremo.



REF. DESCRIPCIÓN

11867 JUEGO DE 2 JUNTAS DE RECAMBIO PARA REF. 52498

Icon	Weight	Volume	Quantity	Price
Kg	0.02	-	100	9,00€

51928

14,00€

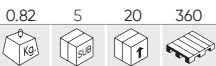

PISTOLA DE SUCCIÓN DE ACEITE



52789

15,20€

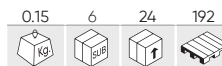

BOMBA MANUAL EXTRACCIÓN GASOIL



- Largo manguera: 90cm por extremo.

50924

342,00€

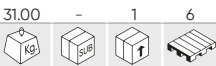

CARRO PORTA BIDONES ESPECIAL ENGRASE

200L



CUBETO RETENCIÓN PARA BIDONES

52804
14.50 - 1 5
Kg SUP f

343,00€
230L 400Kg

HOMOLOGADO DIBT
1 BIDÓN VERTICAL



52805
13.35 - 1 6
Kg SUP f

426,00€
250L 650Kg

HOMOLOGADO DIBT
2 BIDONES VERTICALES



52806
17.50 - 1 5
Kg SUP f

742,00€
250L 1250Kg

HOMOLOGADO DIBT
NO APTO PARA TRANSPALETAS
4 BIDONES VERTICALES



53214
16.50 - 1 12
Kg SUP f

285,00€
380mm 1310mm 910mm

CUBETO RETENCIÓN ESPECIAL EUROPALET
2 BIDONES

230L 650Kg



52807
30.00 - 1 7
Kg SUP f

1.714,00€
700mm 1680mm 1680mm

CUBETO DE RETENCIÓN 1 CONTAINER IBC

1000L 2500Kg



HOMOLOGADO DIBT



54498
221.00 - 1 -
Kg SUP f

CUBIERTA RÍGIDA PARA IBC

Permite el almacenamiento de contenedores IBC. Proporciona al contenedor una máxima protección frente a las inclemencias del tiempo. Dispone de una bandeja recogedora de líquidos de 2 litros de capacidad, cubeto de retención integrado y ranuras de ventilación.

CAPACIDAD DE CONTENEDORES 1000 LITROS: 1 UNIDAD

CAPACIDAD DE BIDONES 200 LITROS: 4 UNIDADES

CAPACIDAD DE CARGA TOTAL: 2500KG.

2500Kg 2500mm 1775mm 1770mm

6.090,00€



INCLUYE LA PARTE INFERIOR
NO INCLUYE CONTENEDOR IBC

53612

96,00€

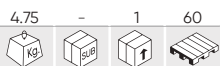

PINZA PARA BIDONES 500KG



- Para manejar bidones de aceite.
- Capacidad: 500kg.
- Agarre del bidón: Tipo vertical.
- Especial para bidones de aceite 200L.



BIDÓN METÁLICO

REF.	L/mm				€
54181	5L - 550x260x350mm	1.45	4	72	25,10€
54182	10L - 570x350x425mm	2.55	4	48	34,70€
54184	20L - 760x370x500mm	4.10	4	24	44,00€



54183

38,20€



BIDÓN METÁLICO 10L ANTI VUELCO



REF.	DESCRIPCIÓN				€	
15874	BOQUILLA FLEXIBLE PARA BIDÓN METÁLICO (REF. 54181/ 54182/ 54183/ 54184)	0.30	-	50	800	6,50€

52452

8,00€



LLAVE PLÁSTICA PARA BIDÓN DE 200L



- Material: Nylon.
- Antichispa y antipolvo.
- Relieves acabado de 3/4" y 2".
- Útil para bidones de 200L.

53078

18,00€



GRIFO PARA BIDÓN DE 200L



- Permite un vaciado rápido de bidones de 200L.
- Puede ser usado para agua, todo tipo de aceites y alcohol.
- Material: polietileno (PE).
- Junta en E PDM.
- Resorte en acero inoxidable.

53518

3,50€



GRIFO PLÁSTICO PARA BIDÓN DE ACEITE 3/4"

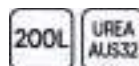

- Válido para todos los líquidos.
- Rosca macho 3/4".

52453

21,00€

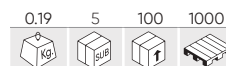

GRIFO PARA BIDÓN ACEITE DE 3/4"

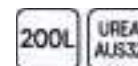

- Grifo de seguridad.
- Rosca de 3/4".
- Cuerpo de Aleación.
- Junta de Nylon.
- Aplicaciones: aceites, lubricantes, gasolina, diesel, queroseno, etc.
- Válido para Urea AUS32.

52242

12,00€

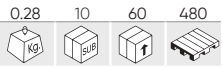

ACEITERA 500ML

500ml



52243

8,50€

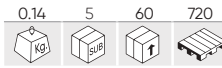

ACEITERA 250ML

250ml



52991

10,50€

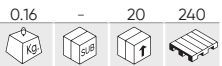

JARRA CON CUELLO FLEXIBLE 2L

2L



52992

18,00€



JARRA CON CUELLO FLEXIBLE 5L

5L



53187

39,00€

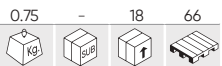

EMBUDO PARA BIDÓN DE 200L CON TAPA Y FILTRO

4,5L



- Ø Interior: 245mm.
- Ø Exterior: 260mm.

53188

7,00€

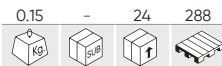

SET DE 3 EMBUDOS

Ø 90,130,180mm



52391

5,00€

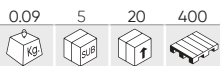

EMBUDO CON FILTRO



53198

9,50€

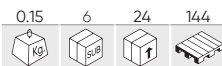

EMBUDO CON TUBO FLEXIBLE



53849



PISTOLA ENGRASADORA MINI



16,10€

50852

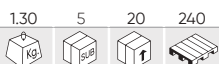

PISTOLA ENGRASADORA MANUAL CON TUBO FLEXIBLE

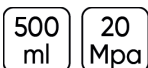

24,50€

50751



PISTOLA ENGRASADORA NEUMÁTICA

- Tubo rígido.
- Tubo flexible.
- Presión: 30Mpa.



43,00€

53592

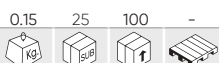

ACOPLADOR DE GRASA DE LIBERACIÓN RÁPIDA



25,00€

54255



SET DE ACCESORIOS PARA PISTOLA ENGRASADORA



68,00€

Se recomienda utilizarlo con las pistolas engrasadoras JBM REF. 50751 y 50852, aunque su uso es adecuado para la mayoría de las pistolas.

60038



PISTOLA ENGRASADORA A BATERÍA

BATERÍA NO INCLUIDA

Esta herramienta ha sido diseñada para tareas de lubricación. Puede ser fácilmente transportada y manipulada en cualquier lugar gracias a su diseño.



255,00€

HERRAMIENTAS HIDRÁULICAS

- 314 GATOS CARRETILLA
- 316 GATOS BOTELLA
- 317 GATOS DE TRINQUETE
- 317 GATOS DE FOSO
- 318 CABALLETES
- 318 OTROS
- 320 TRANSPALETAS
- 321 PRENSAS
- 322 GRÚAS
- 323 MESAS ELEVADORAS
- 325 TACOS PARA ELEVADORES



HERRAMIENTAS HIDRÁULICAS

53725

248,00€

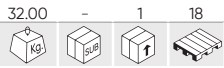

GATO HIDRÁULICO CON SISTEMA DE SUBIDA RÁPIDA 3T



MAX: 465mm
MIN: 133mm



DESPIECE DISPONIBLE

CUMPLE CON: EN 1494:2001

50818

198,00€

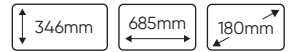
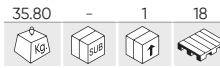

GATO HIDRÁULICO CARRETILLA 3.5T



MAX: 495mm
MIN: 133mm



DESPIECE DISPONIBLE

CUMPLE CON: EN 1494:2001

53422

368,00€

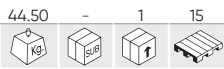

GATO HIDRÁULICO CON PALANCA DE ELEVACIÓN 3T



MAX: 533mm
MIN: 100mm



DESPIECE DISPONIBLE

50815

88,00€

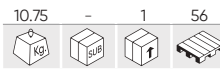

GATO HIDRÁULICO CARRETILLA 2T



MAX: 355mm
MIN: 130mm



DESPIECE DISPONIBLE

53112

298,00€

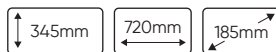
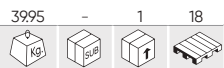

GATO HIDRÁULICO CON PEDAL 3T



MAX: 520mm
MIN: 140mm



DESPIECE DISPONIBLE

53968

49,00€

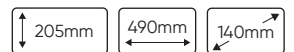
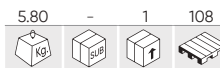

GATO HIDRÁULICO CARRETILLA 2T



MAX: 300mm
MIN: 130mm



DESPIECE DISPONIBLE

CUMPLE CON: EN 1494:2001

51895

99,00€

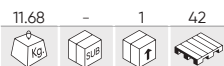

GATO HIDRÁULICO CARRETILLA EN CAJA PLÁSTICA 2T



50816

88,00€



GATO HIDRÁULICO CARRETILLA ESPECIAL COCHES BAJOS 2T



53421

298,00€

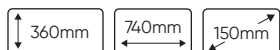
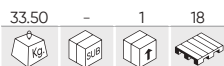

GATO HIDRÁULICO ESPECIAL COCHES BAJOS 2T

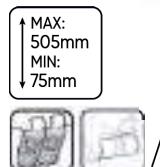

54137

288,00€

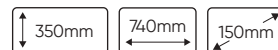

GATO HIDRÁULICO ESPECIAL COCHES BAJOS 2.5T

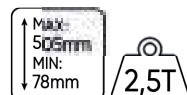

DOBLE PISTÓN

TUTORIAL DE MANTENIMIENTO



GATOS HIDRÁULICOS PARA COCHES BAJOS

OFRECEN UNA ADAPTACIÓN ÓPTIMA PARA VEHÍCULOS DE PERFIL BAJO GRACIAS A SU ALTURA REDUCIDA Y SU DISEÑO CURVADO.

GATOS BOTELLA

<p>50819 28,00€</p> <p>2.42 - 6 330</p> <p>MAX: 345mm MIN: 181mm</p> <p>2T</p> 	<p>50820 34,50€</p> <p>3.20 - 6 300</p> <p>MAX: 372mm MIN: 194mm</p> <p>3T</p> 	<p>50821 47,00€</p> <p>4.10 - 5 200</p> <p>MAX: 413mm MIN: 216mm</p> <p>5T</p> 
<p>50822 59,00€</p> <p>5.60 - 4 200</p> <p>MAX: 460mm MIN: 230mm</p> <p>10T</p> 	<p>52304 84,00€</p> <p>7.20 - 2 136</p> <p>MAX: 365mm MIN: 225mm</p> <p>15T</p> 	<p>50823 94,00€</p> <p>10.18 - 2 96</p> <p>MAX: 452mm MIN: 242mm</p> <p>20T</p> 
<p>50824 88,00€</p> <p>8.47 - 2 120</p> <p>MAX: 355mm MIN: 190mm</p> <p>20T</p> <p>COCHES BAJOS</p> 	<p>50825 154,00€</p> <p>7.62 - 2 96</p> <p>MAX: 468mm MIN: 285mm</p> <p>30T</p> 	

GATOS BOTELLA CON CAJA PLÁSTICA

<p>51905 34,50€</p> <p>2.90 - 6 144</p> <p>MAX: 340mm MIN: 185mm</p> <p>2T</p> 	<p>51906 39,00€</p> <p>3.53 - 4 144</p> <p>MAX: 385mm MIN: 195mm</p> <p>3T</p> 	<p>51907 48,00€</p> <p>4.59 - 4 128</p> <p>MAX: 450mm MIN: 215mm</p> <p>5T</p> 
---	---	---

GATOS ELEVADORES DE TRINQUETE 3T

REF.	Min.	Max.	mm				€
53895	130mm	330mm	510x265x140	9.15	1	42	107,00€
53896	130mm	645mm	840x265x140	11.60	1	28	127,00€
53897	130mm	1045mm	1220x265x140	13.85	1	21	140,00€
53898	130mm	1320mm	1520x265x140	15.65	1	21	148,00€



ACCESORIOS

REF.	DESCRIPCIÓN				€
15093	SOPORTE PARA RUEDA DE RECAMBIO	3.65	1	50	38,00€
15094	BASE OFF-ROAD	1.35	5	140	39,50€
15095	SOPORTE DE BLOQUEO DEL MANGO	0.10	50	-	13,00€
15096	GANCHO DE ELEVACIÓN	2.00	10	560	40,00€

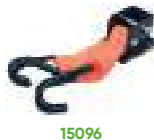

54001

285,00€

28.50	-	1	20

GATO DE FOSO 500KGS



- Rango de elevación de 116 a 197 cm.
- Soporte de doble posición.
- Elevación cómoda y rápida con pedal.
- Válvula con muelle para descenso controlado.
- Permite elevar y mover cajas de cambio, diferenciales y depósitos, entre otros, de forma segura y estable.

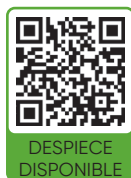

50830

560,00€

52.10	-	1	6

GATO HIDRÁULICO DE TRANSMISIÓN 500KG



- Con agarradero
- Doble pistón



HERRAMIENTAS HIDRÁULICAS

JUEGO DE 2 CABALLETES

REF.	DESCRIPCIÓN					€
53779	3T 290-430mm	5.05	-	1	72	36,00€
53845	6T 370-610mm	9.35	-	1	30	64,00€
54143	12T 500-770mm	35.50	-	1	12	249,00€



JUEGO DE 2 CABALLETES 10 TON

REF.	DESCRIPCIÓN					€
54145	10T 482-775mm	37.90	-	1	4	377,00€
54146	10T 736-1212mm	2.00	-	1	4	492,00€



54147

198,00€



CABALLETE DE ELEVACIÓN 1.8 TON (1220-2146MM)



54144

298,00€



JUEGO DE 2 CABALLETES 22 TON (338-500MM)

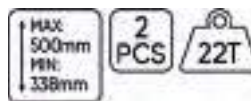

53200

69,00€

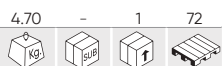

JUEGO 2 CABALLETES DE ALUMINIO 3T

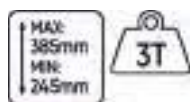

53218

26,00€



GATO DE TIJERA 1.5T



51901

999,00€



PORTA RUEDAS HIDRÁULICO



- Largo total: 1040mm.
- Anchura total: 1090mm.
- Altura total: 890mm.
- Rango de elevación: 50 - 100mm.
- Diámetro máx. de las ruedas: 1.320mm.

ESPECIAL CAMIÓN



52241

1.690,00€



PORTA RUEDAS HIDRÁULICO ESPECIAL PARA RUEDAS TRACTOR



- Capacidad: 1,5T
- Rango de elevación: 0-770mm
- Largo total: 1270mm
- Anchura total: 990mm
- Altura total: 1340mm
- Diámetro máximo de rueda: 2200mm (86")
- Diámetro mínimo de rueda: 1000mm (39")
- Ancho máximo de rueda: 800mm



54257

318,00€

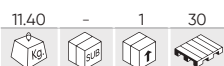

BOMBA HIDRÁULICA MANUAL

10000 PSI / 3/8" NPT

PRESIÓN DE TRABAJO:
- Etapa 1: 0-20 kg/cm³
- Etapa 2: 20-700 kg/cm³

1,8m

CAUDAL POR EMBOLADA:
- Etapa 1: 13cc
- Etapa 2: 2.3cc



50835

290,00€

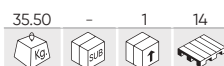

CURVADORA DE TUBOS 12T



- Capacidad máxima: 12T
- Presión del aire: 0,75 - 0,85mpa
- Dimensiones: 68x58,5x18,5cm
- Tamaños cuñas: 1/2", 3/4", 1", 1-1/4", 1-1/2", 2".

HERRAMIENTAS HIDRÁULICAS

53880

598,00€

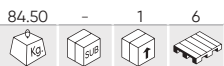

TRANSPALETA MANUAL ELEVACIÓN RÁPIDA

- Capacidad de carga: 2500kg
- Longitud horquilla: 1150mm
- Empuñadura: Cuadrada con protección de goma.
- Ruedas de dirección: PU (200x50mm)
- Rodillos de carga: PU (80x70mm)
- Altura mínima horquilla: 85mm
- Altura máxima horquilla: 200mm
- Velocidad de elevación: 8

BOMBA DE ELEVACIÓN RÁPIDA (ACERO FUNDIDO)



DESPIECE DISPONIBLE

54396

2.250,00€



N

TRANSPALETA ELÉCTRICA



DESPIECE DISPONIBLE



INFORMACIÓN TÉCNICA

50839

180,00€

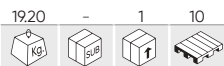

PORTADOR HIDRÁULICO 680KGS



DESPIECE DISPONIBLE



50923

454,00€

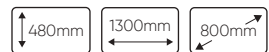

CARRO TRANSPORTADOR ESPECIAL PLANCHA 340KG



DESPIECE DISPONIBLE



52514

84,00€

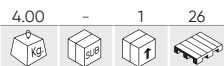

SOPORTE DELANTERO ELEVADOR PARA MOTO 200KG



DESPIECE DISPONIBLE



51751

99,00€



SOPORTE TRASERO ELEVADOR PARA MOTO 200KG



DESPIECE DISPONIBLE



53684

1.880,00€

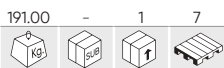

PRENSA DE 30T

- Capacidad (T): 30.
- Trazo (mm): 160.
- Rango operativo (mm): 166-1126.
- Ancho de la base (mm): 540.
- Accionado manual y con el pie.
- Trazo lateral (mm): 200.
- Recorrido (mm): 150.



53590

1.190,00€



PRENSA DE 20T

- Capacidad (T): 20.
- Trazo (mm): 145.
- Rango operativo (mm): 58-1018.
- Ancho de la base (mm): 640.
- Ancho interior (mm): 536.
- Trazo lateral (mm): 180.



DESPIECE DISPONIBLE

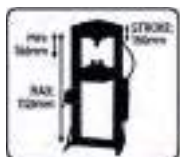

DESPIECE DISPONIBLE

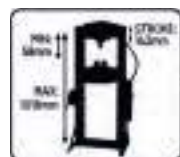

REF. DESCRIPCIÓN

14616 PANTALLA PROTECTORA PARA PRENSA HIDRÁULICA DE 20T/30T (REF.53590/ 53684)



€

96,00€



52999

178,00€



BASE DE TRABAJO PARA PRENSA HIDRÁULICA

BLOQUE GRANDE



BLOQUE PEQUEÑO



50827

387,00€

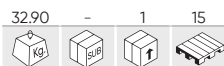

COMPRESOR DE MUELLES PARA AMORTIGUADORES

- Capacidad: 1T (2200 lbs)
- Diámetro del muelle comprimido: 200mm
- Rango de compresión: 200-500mm



HERRAMIENTAS HIDRÁULICAS

50831

460,00€

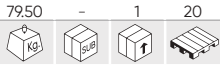

GRÚA DE 2 TONELADAS PLEGABLE



DESPIECE DISPONIBLE

52985

598,00€

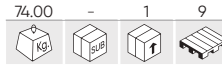

GRÚA DE 1 TONELADA PLEGABLE



DESPIECE DISPONIBLE

50631

68,00€

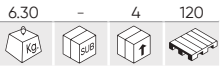

SOPORTE ALINEADOR DE MOTOR 750KG



50840

138,00€

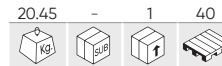

SOPORTE PARA MOTORES 500KG (1750MM)



REF.	DESCRIPCIÓN		€
51452	ENGANCHE Y PALOMILLA PARA REF.50840	3.43 - 1 50	69,00€

53682

98,00€

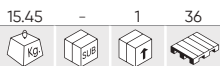

SOPORTE PARA MOTORES 500KG (1480MM)



52055

139,00€



SOPORTE PARA MOTORES UNIVERSAL 500KG



50836

148,00€

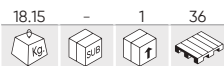

SOPORTE PARA MOTORES 340KG



850mm

900mm

800mm



50838

299,00€

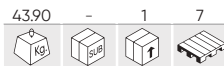

SOPORTE PARA MOTORES 900KG



- Dimensiones plegado: 1000x500x440mm.

900mm

1100mm

900mm



POLIPASTO MANUAL

54262

88,00€



54263

130,00€



54264

240,00€



	54262	54263	54264
ALTURA DE ELEVACIÓN	2,8m	2,8m	2,8m
Nº DE RAMALES	1	2	2
MEDIDAS DEL PASO CADENA		Cadena de carga: 6x30mm Cadena manual: 4,5x25mm	
LONGITUD		Cadena de carga: 3m Cadena manual: 2,5m	
ESFUERZO PARA CARGA MÁXIMA	304N	310N	361N
MATERIAL		Cadena de carga: Acero 20Mn2 Cadena manual: Acero Q235	



52845

170,00€

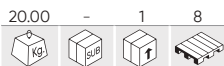

SET DE 2 RAMPAS ELEVADORAS 1 TON

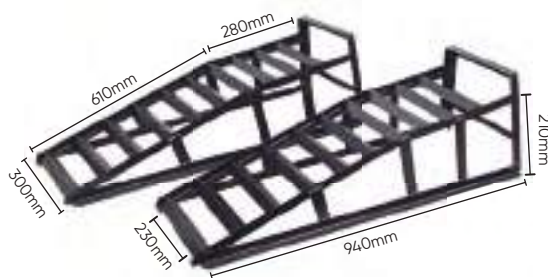

53423

199,00€

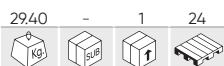

790mm

370mm

330mm

GATO ELEVACIÓN QUAD



MAX: 368mm
MIN: 118mm

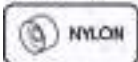

DESPIECE DISPONIBLE

53969

96,00€



328mm

293mm

CABALLETE ELEVADOR DE MOTOCICLETA



MAX: 400mm
MIN: 300mm



54386

5.839,00€

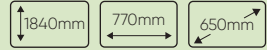
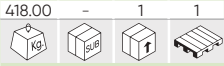

N

MESA HIDRÁULICA PARA BATERÍAS DE VEHÍCULOS ELÉCTRICOS

Esta mesa hidráulica para baterías de vehículos eléctricos asegura una correcta y segura manipulación. Dispone de 6 tacos de goma aislados eléctricamente que le permiten trabajar sin riesgo con baterías de vehículos eléctricos. La altura de cada uno de estos tacos se puede ajustar independientemente. La plataforma lleva incorporada varias llaves giratorias que le permiten ajustar de manera muy precisa la altura. En caso necesario, puede extender la longitud de la plataforma. Además, opera con dos cilindros para proporcionar mayor rapidez de subida y bajada.

En cuanto a seguridad, dispone de dientes de seguridad que evitan que la plataforma pueda caer bruscamente. También cuenta con un sistema de protección automático que evita que se supere la elevación máxima permitida y dos ruedas con frenos.



DESPIECE DISPONIBLE

Características de carga	Carga distribuida
Tiempo de elevación (sin carga)	60"
Tiempo de descenso (sin carga)	45"
Plataforma	1290 - 1400x768mm

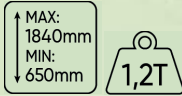

52692

129,00€

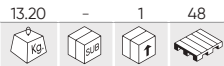

GATO PARA MOTOCICLETA



50911

788,00€

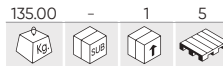

MESA HIDRÁULICA PARA MOTOCICLETAS



DESPIECE DISPONIBLE

53246

1.144,00€

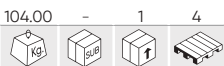

MESA HIDRÁULICA 360KG



50630

590,00€



MESA HIDRÁULICA 400KG



DESPIECE DISPONIBLE

TACOS DE GOMA PARA ELEVADORES

54349 8,00€ 0.48 - 68 - A 160mm B 120mm C 20mm	54350 12,50€ 0.67 - 48 - A 160mm B 120mm C 30mm	54351 14,00€ 0.97 - 32 - A 160mm B 120mm C 40mm	54352 18,00€ 1.43 - 20 - A 160mm B 120mm C 60mm
--	---	---	---

54353 23,50€ 1.85 4 12 - A 160mm B 120mm C 80mm	54354 34,50€ 2.91 - 8 270 A 160mm B 120mm C 120mm	54483 14,00€ 0.70 - 40 - A 160mm B 120mm C 35mm	54484 26,00€ 1.75 - 20 - A 160mm B 120mm C 70mm
---	---	---	---

54485 36,00€ 2.40 - 8 - A 160mm B 120mm C 100mm	54355 12,00€ 0.20 - 60 - RAVAGLIOLI/SIRIO/SPACE A 123mm D 108mm B 26mm E 10mm C 104mm	54360 14,00€ 0.19 - 72 - RAVAGLIOLI/SIRIO/SPACE A 130mm D 125mm B 23mm E 10mm C 121mm	54486 9,50€ 0.10 - 120 - RAVAGLIOLI/SIRIO/SPACE A 100mm D 85mm B 22mm E 8,5mm C 81mm
---	--	--	---

54488 15,00€ 0.25 - 40 - RAVAGLIOLI A 150mm D 135mm B 25mm E 10mm C 128mm	54493 13,50€ 0.20 - 60 - RAVAGLIOLI A 120mm B 110mm C 27mm	54494 14,00€ 0.30 - 48 1152 RAVAGLIOLI A 145mm B 135mm C 26mm	54357 15,00€ 0.29 - 60 - TWIN BUSCH A 120mm D 105mm B 30mm E 8,5mm C 100mm F 66mm
--	---	--	---

54358 18,50€ 0.36 - 44 - TWIN BUSCH A 140mm D 125mm B 25mm E 10mm C 116mm F 66mm	54361 14,00€ 0.25 - 52 - TWIN BUSCH A 140mm D 125mm B 28mm E 8mm C 120mm	54363 14,00€ 0.30 - 44 - ISTOBAL/VELYEN A 155mm D 147mm B 24mm E 6mm C 140mm	54365 12,50€ 0.20 - 108 - ISTOBAL/VELYEN A 145mm B 10mm C 60mm
--	---	---	---

TACOS DE GOMA PARA ELEVADORES

54359 14,00€

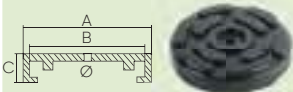

OMCN

- A 140mm
- B 133mm
- C 27mm

54491 17,50€



OMCN

- A 145mm
- B 25mm

54366 18,50€

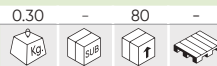

NASSBAUM/AMI

- A 125mm D 120mm
- B 24mm
- C 90mm

54362 14,00€

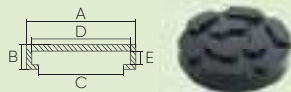
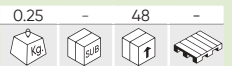

CASCOS

- A 138mm D 130mm
- B 25mm E 9mm
- C 120mm

54487 15,00€

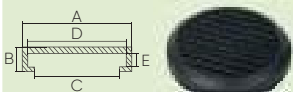

ROTARY

- A 123mm D 112mm
- B 22mm E 8mm
- C 90,5mm

54495 18,00€

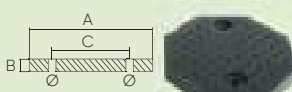

ROTARY

- A 125mm
- B 15mm
- C 90mm

54496 16,50€

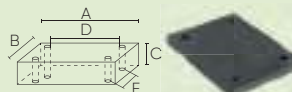

ROTARY

- A 104mm D 80mm
- B 82mm E 56mm
- C 8mm

54497 12,50€

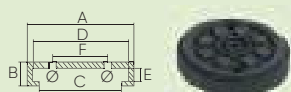

MAHA

- A 120mm D 113mm
- B 22mm E 8mm
- C 102mm F 83mm

54492 19,50€

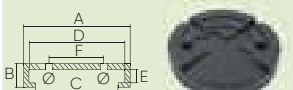

SLIFT/IME

- A 125mm D 110mm
- B 25mm E 9mm
- C 120mm F 83mm

54356 19,50€

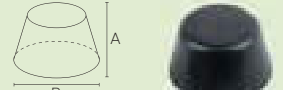

500E/500X/JEEP RENEGADE

- A 55mm
- B 100mm

54364 14,00€

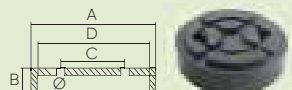

LAUNCH/TWIN BUSCH/RP TOOLS

- A 120mm D 108mm
- B 32mm
- C 70mm

54489 19,50€

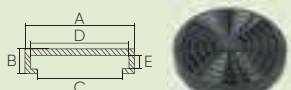

KONI/ROMERICO/CAR-O-LINER

- A 160mm D 153mm
- B 29mm E 10mm
- C 140mm

54490 15,00€

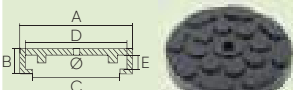

ATH/HOFMANN/
HERMANN/J.A.B. BECKER

- A 120mm D 110mm
- B 19mm E 4mm
- C 130mm

54175 34,00€



SET DE 4 TACOS PARA ELEVACIÓN TESLA



HERRAMIENTAS ELÉCTRICAS

- 328 ARRANCADOR DE VEHÍCULO
- 329 MANTENIMIENTO DE LA BATERÍA
- 330 MEDICIÓN DE CORRIENTE
- 332 INSPECCIÓN VISUAL
- 332 SOLDADURA
- 334 EQUIPAMIENTO DE TALLER
- 337 CLIMATIZACIÓN
- 338 TERMÓMETROS
- 338 OTROS



HERRAMIENTAS ELÉCTRICAS

CABLES DE ARRANQUE

PINZA MACIZA DE LATÓN

REF.	Ø CABLE	LARGO	A	SECCIÓN					€
51238	17mm	5m	700	70mm ²	4.95	-	2	84	138,00€
51239	15mm	7m	700	70mm ²	5.90	-	2	72	159,00€

PINZA DE LATÓN

REF.	Ø CABLE	LARGO	A	SECCIÓN					€
52069	11mm	2,5m	250	25mm ²	1.55	-	10	240	29,50€
52070	12mm	3m	350	35mm ²	1.95	-	5	160	40,00€
52071	13mm	3m	500	50mm ²	2.35	-	5	90	47,00€

PINZA MACIZA DE LATÓN CON PROTECTOR DE SOBRECARGA

REF.	Ø CABLE	LARGO	A	SECCIÓN					€
51363	12mm	3m	350	35mm ²	2.63	-	5	120	114,00€
51365	12mm	3m	600	50mm ²	3.10	-	5	90	118,00€



REF. DESCRIPCIÓN

REF.	DESCRIPCIÓN					€
14145	PINZA PARA CABLE DE ARRANQUE - COBRE - ROJA	0.20	-	30	-	8,50€
14146	PINZA PARA CABLE DE ARRANQUE - COBRE - NEGRA	0.20	-	30	1920	8,00€
14147	PINZA PARA CABLE DE ARRANQUE - LATÓN - ROJA	0.35	-	15	-	25,00€
14148	PINZA PARA CABLE DE ARRANQUE - LATÓN - NEGRA	0.35	-	15	-	25,00€

53687

298,00€

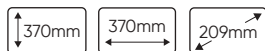
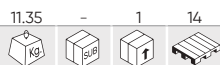

ARRANCADOR DE VEHÍCULOS 12V

- Voltaje: 12V.
- Batería: 22Ah batería de plomo ácido AGM (1PC).
- Corriente de arranque: 750A.
- Corriente máxima: 150A.

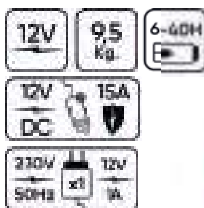

DESPIECE DISPONIBLE

- A MEDIDOR DE VOLTAJE DE LA BATERÍA INTERNA
- B BOTÓN DE COMPROBACIÓN DE VOLTAJE DE LA BATERÍA INTERNA
- C INTERRUPTOR ENCENDIDO/APAGADO
- D LUZ LED INCORPORADA: AMPLÍA LA VISIBILIDAD DE LA ZONA DE TRABAJO

53688

495,00€



ARRANCADOR DE VEHÍCULOS 12/24V

- Voltaje: 12V/24V.
- Batería: 22Ah batería de plomo ácido AGM (2PC).
- Corriente de arranque: 12V: 1500A/3000A.
- Corriente máxima: 24V: 750A/1500A.
- Tiempo de carga de la batería: Batería totalmente descargada: 8 horas. Batería cargada un 10-20%: 4 horas

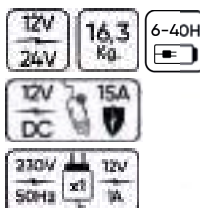

DESPIECE DISPONIBLE

- A MEDIDOR DE VOLTAJE DE LA BATERÍA INTERNA
- B BOTÓN DE COMPROBACIÓN DE VOLTAJE DE LA BATERÍA INTERNA
- C INTERRUPTOR ENCENDIDO/APAGADO
- D LUZ LED INCORPORADA: AMPLÍA LA VISIBILIDAD DE LA ZONA DE TRABAJO

51816

58,00€

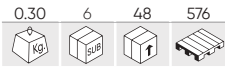

COMPROBADOR DE BATERÍAS DIGITAL

- 150Ah.
- Aplicable en baterías de 12V.
- Medición en SAE (CCA), EN, IEC, DIN, CA.
- Rango: 200~1 200 CAA (SAE).
- Medidor de voltio: 7V~15 V.
- Display 4 + 3 Leds (verde, rojo, amarillo).



51235

49,00€

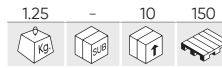

COMPROBADOR DE BATERÍA

- Para baterías de 6V y 12V.
- Carga de hasta 100Ah.
- Test de Estado de carga.
- Test de consumo de Arranque.
- Test de Voltaje de carga.
- Test de Condición de la Batería.



52884

73,00€

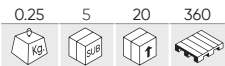

MEMORIZADOR PARA CAMBIO DE BATERÍA



- Útil para mantener corriente en el sistema eléctrico del vehículo durante el cambio de batería.
- Conexión mediante cable OBDII o toma de mechero.



53209

8,50€

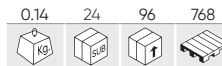

DENSÍMETRO PARA BATERÍAS

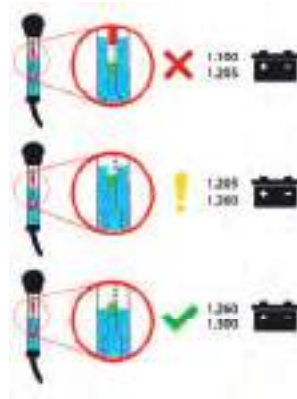

CARGADORES DE BATERÍA

Compatible con TODAS las baterías de plomo ácido.

53927

66,00€



53929

95,00€



52233

328,00€



COMPROBADOR DE BATERÍA Y ALTERNADORES CON IMPRESORA

- Aplicable a baterías de 6V y 12V.
- Sistemas de carga y encendido de 12V y 24V.
- Rango de operación: 40 - 2000 CCA (SAE).
- Voltímetro: 1.5V - 30V.
- Juego de cables de 180cm.
- Incluye: 1 rollo de papel térmico.



54040

240,00€

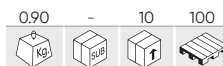

COMPROBADOR DE BATERÍA CON IMPRESORA

- Aplicable a baterías de 12V
- Rango de operación: 100 - 2000 CCA (SAE)
- Idiomas disponibles en el sistema: ES (Español), EN (Inglés), FR (Francés), DE (Alemán), IT (Italiano), PT (Portugués), RO (Rumano)
- Aplicable a sistemas de arranque de 12/24V
- Aplicable a baterías de 12V, AGM, GEL, VRLA, SLI.
- Comprobador de arranque y alternador.
- Incluye: Pila CR2032



REF.	DESCRIPCIÓN				€
51842	PAPEL TÉRMICO PARA IMPRESORA REF. 52233 - 54040	0.10	6	72	6,90€

54256

48,00€



SALVAPICOS 12/24V



52231

49,00€

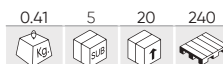

SET DE ACCESORIOS PARA MULTÍMETRO

Kit apto para la mayoría de multímetros.

- CONTIENE**
- 2 sondas.
 - 2 pinzas pequeñas.
 - 2 pinzas largas.
 - Cables de extensión.



54114

248,00€

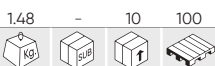

MEDIDOR DE AISLAMIENTO



Categoría de instalación:	2	Temperatura de almacenamiento:	-10°C - 60°C (14°F - 140°F), humedad relativa inferior al 70%
Categoría de medición:	CAT III	Fuente de potencia:	9V corriente continua (6 pilas "AA" de 1.5V)
Altitud:	Hasta 2000 metros	Tamaño:	200 x 92 x 50mm
Pantalla:	LCD con doble lectura		
Voltaje AC:	0 - 750V		
Voltaje DC:	0 - 1000V		
Resistencia:	0 - 200Ω / 200 - 2000 Ω		
Resistencia de aislamiento:	0 - 200MΩ / 200 - 2000MΩ		
Velocidad de muestreo:	2.5 veces por segundo		
Ajuste cero:	Ajuste automático		
Temperatura de trabajo:	0° - 40°C (32°F - 104°F), humedad relativa inferior al 80%		



50942

28,00€

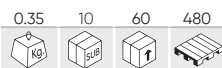

MULTÍMETRO DIGITAL

- Indicador de batería.
- Baterías de 9V.
- Sonda de temperatura.
- Temperatura de -40°C a 1000°C.
- Datos instantáneos.
- Autoapagado.



AC	AC
200mV, 2V, 20V, 200V, 1000V	20mA, 200mA, 20A
DC	DC
200mV, 2V, 20V, 200V, 750V	20mA, 200mA, 20A
Ω	F
200Ω, 2KΩ, 20KΩ, 200KΩ, 2MΩ, 20MΩ, 2000MΩ	2nF, 20nF, 200nF, 2μF, 20μF, 200μF

52439

227,00€



JUEGO DE CABLE Y ACC. PARA MULTÍMETRO

- CONTIENE**
- 2 medidores de resistencia variable.
 - 2 luces led de comprobación.
 - 2 alicates de cocodrilo.
 - 2 tomas de enganche rápido.
 - 4 sondas.
 - 24 conectores forma redonda.
 - 48 conectores forma plana.
 - 2 SRS sustitución y de los dispositivos de prueba.



52382

19,50€

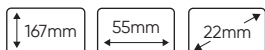

PINZA AMPERIMÉTRICA

- Se puede medir: Voltaje AC, voltaje DC, corriente AC, resistencia, diodo y frecuencia.
- Instrumento ideal para electricistas
- Entorno de funcionamiento: 0°C a 40°C, a <80%RH.
- Entorno de almacenamiento: -10°C a 40°C, a <85%RH.
- Alimentación: 2 pilas AAA.
- Indicador de batería baja.
- Pantalla de 3,5" con 4 dígitos.
- Función de corriente continua.
- Medición de voltaje AC/DC.



DCB 600V	FUNCIONES Test de cable.
ACB 600V	
DCA -	
ACA 20A, 200A, 600A	
OHM 2KΩ, 200KΩ, 2MΩ	

52952

74,00€



PINZA AMPERIMÉTRICA PROFESIONAL

- Se puede medir: Voltaje AC, voltaje DC, corriente AC, resistencia, diodo y frecuencia.
- Instrumento ideal para electricistas
- Entorno de funcionamiento: 0°C a 40°C, a <80%RH.
- Entorno de almacenamiento: -10°C a 40°C, a <85%RH.
- Alimentación: 2 pilas AAA.
- Indicador de batería baja.
- Pantalla de 3,5" con 4 dígitos.
- Función de corriente continua.
- Medición de voltaje AC/DC.



DCB 20V, 600V	FUNCIONES Test de cable. Test de diodo. Test de continuidad. Función ADP. Función de detección de fase. Interruptor ZERO.
ACB 600V	
DCA 200A	
ACA 200A	
OHM 2000Ω	

53028

5,80€

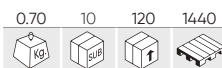

COMPROBADOR DE CORRIENTE 1,8X190MM

6-12-24V
1,8 x 190mm



- Aptos para comprobar la polaridad

53029

6,80€

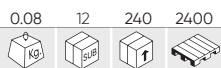

COMPROBADOR DE CORRIENTE 2X115MM

6-12-24V
2 x 115mm



53030

12,00€



COMPROBADOR DE CORRIENTE 3X142MM

6-12-24V
3 x 142mm
LED



HERRAMIENTAS ELÉCTRICAS

53724

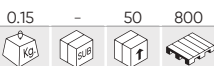

ENDOSCOPIO WIFI

- Endoscopio con conexión wifi compatible con todos los smartphones del mercado. Apta para conectar con tabletas y PC.

- El equipo incluye:
Endoscopio.
Cargador.
Punta de gancho.
Punta magnética.
Punta con espejo para visión lateral.

CABLE DE 1M SEMIRÍGIDO



46,00€

FUNCIONA CON LA APP DE JBM:



53484

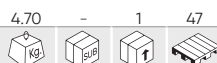

DETECTOR DE FUGAS POR HUMO

- NO INCLUYE ACEITE.

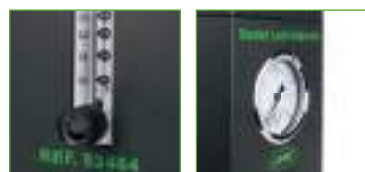
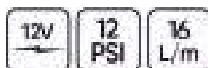

CONTIENE



615,00€

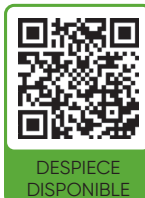
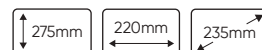

DESPIECE DISPONIBLE

53977

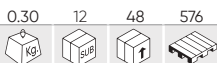

SOLDADOR DE 40W

- Voltaje: 220-240V
- 40W
- Frecuencia: 50Hz
- Largo: 240mm
- Cable: 1,3m
- Temperatura de trabajo máxima: 450°+/-10%

17,50€

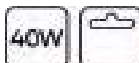

53111



SOLDADOR DE ESTAÑO 100W

- Voltaje: 220-240V.
- 100W
- Largo: 250mm.
- Cable: 1,5m.
- Temperatura de trabajo máxima: 420°C + / - 10%.

19,00€



53145



PISTOLA DE CALOR 2000W

- 220V-240V.
- 50Hz-60HZ.
- 2000W.
- Temperatura de salida: 50-600°C.
- Flujo de aire: 220-480L/min.
- 2 opciones de temperatura: 300 y 600°C.

39,20€



53162



PISTOLA DE CALOR DIGITAL 2000W

- 220V-240V.
- 50Hz-60HZ.
- 2000W.
- Temperatura de salida: 100-600°C.
- Flujo de aire: 280-480L/min.

60,00€



53981

143,00€

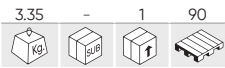

SOLDADORA INVERTER MMA 100A DC

CONTIENE

- Portaelectrodo con cable de 2m.
- Pinza de masa para soldadura con cable de 1.5m.
- Máscara protectora facial.
- Martillo de soldadura con cepillo.

- ✓ TECNOLOGÍA INVERTER IGBTB
- ✓ MMA DC
- ✓ ANTI STICK
- ✓ ARC FORCE
- ✓ HOT ARC START



DESPIECE DISPONIBLE

53982

219,00€

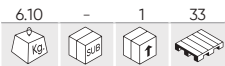

SOLDADORA INVERTER MMA 160A DC

CONTIENE

- Portaelectrodo con cable de 2m.
- Pinza de masa para soldadura con cable de 1.5m.
- Máscara protectora facial.
- Martillo de soldadura con cepillo.

- ✓ TECNOLOGÍA INVERTER IGBTB
- ✓ MMA DC
- ✓ ANTI STICK
- ✓ ARC FORCE
- ✓ HOT ARC START



DESPIECE DISPONIBLE

53414

49,00€



CASCO PARA SOLDADURA CON REGULADOR MANUAL



REGULADOR DE SENSIBILIDAD Y OSCURECIMIENTO ANALÓGICO

53415

188,00€



CASCO PARA SOLDADURA CON REGULADOR DIGITAL



REGULADOR DIGITAL DE SENSIBILIDAD, OSCURECIMIENTO Y CADENCIA

ESCUADRAS MAGNÉTICAS 45°, 90°, 135°

REF.	←→					€
54111	75mm	0.35	10	40	1680	4,75€
54113	100mm	0.60	10	20	1100	7,65€



HERRAMIENTAS ELÉCTRICAS

54482

15.00	-	1	-

325mm	530mm	325mm
-------	-------	-------

N

677,00€

LIMPIADOR DE PIEZAS ULTRASÓNICO 30L

Esta máquina le permite limpiar piezas mediante la emisión de ultrasonidos. Está especialmente indicada para la limpieza de piezas con formas complejas.

POTENCIA DE ULTRASONIDOS: 600W	FUENTE DE ALIMENTACIÓN: 200~240V (50HZ)
POTENCIA DE CALENTAMIENTO: 500W	NÚMERO DE TRANSDUCTORES: 10
CAPACIDAD DEL TANQUE: 30L	TEMPERATURA: 0~80°C
FRECUENCIA ONDAS ULTRASÓNICAS: 40KHZ	MATERIAL: ACERO INOXIDABLE SUS304
TEMPORIZADOR: 1~30 MIN.	DIMENSIONES DEL TANQUE: 500x300x200mm



53220

790	-	1	8

260,00€

LIMPIADORA DE PIEZAS PORTÁTIL

- FORMATO PORTÁTIL.
- Permite el cierre estanco para evitar pérdidas durante el transporte.
- Usar con disolvente de base acuosa.
- Interruptor de encendido lateral.
- Filtro de limpieza de líquido incluido.
- Colgador de herramientas y de manguera incluido.
- Compartimento de almacenamiento.
- Separación de áreas de trabajo, área de limpieza y área de secado, permite el trabajo con varias piezas a la vez.
- Capacidad máxima: 27,5L.
- Capacidad de bombeo: 1.000 L/h.
- Capacidad de trabajo: 20L.
- Conexión a 220V.
- Manguera de 1,10m de largo.



AMOLADORAS ELÉCTRICAS

REF.	W	V/W	RPM	HZ								€
53656	450W	230V/450W	2950RPM	50Hz	ø 150mm	ø 20mm	ø 12,7mm	11.05	-	1	50	198,00€
53657	600W	230V/600W	2950RPM	50Hz	ø 200mm	ø 25mm	ø 15,88mm	16.35	-	1	24	248,00€
53658	250W	230V/250W	2950RPM	50Hz	ø 150mm	ø 20mm	ø 12,7mm	6.95	-	1	60	99,00€
53659	250W	230V/250W	2950RPM	50Hz	ø 150mm ø 200mm	ø 20mm ø 40mm	ø 12,7mm ø 20mm	9.70	-	1	15	121,00€



53656
53657



53658



53659

52195

7.08	-	1	48

170,00€

AMOLADORA ELÉCTRICA 150MM

- Potencia nominal entrada: 250W.
- Tensión nominal: 230V / 50Hz.
- Velocidad sin carga: 2.950Rpm.
- Ø de la rueda: 150 x 20 x 12.7mm.



53660

8.60	-	1	28

146,00€

BASE METÁLICA PARA AMOLADORA

- Altura: 790mm.
- Medidas de la placa de fijación: 250x280mm.
- Peso: 8kg.



334

IVA no incluido

JBM

www.jbmcamp.com

54342 858,00€

49.50 - 1 4

MÁQUINA LIMPIADORA DE PIEZAS CON TERMOSTATO

70-120 PSI 0,8 L/min
 MAX 50°C 8-14L
 5 CFM 300mm 500mm 450mm

1710mm
 790mm
 610mm

Máquina diseñada para un lavado perfecto de piezas sucias. Incorpora una pistola neumática para efectuar la limpieza con disolvente y que también se puede utilizar para secar la pieza mediante aire comprimido. Gracias a su cabina cerrada, el operario queda totalmente protegido ante salpicaduras y el mal olor del disolvente.

Dispone de un termostato con el que puede graduar el nivel de temperatura del líquido limpiador y luz en el dentro del tanque para una mejor visualización.

DESPIECE DISPONIBLE

54341 643,00€

51.00 - 1 7

MÁQUINA CHORREADORA DE ARENA 220L

100V 240V 40-120 PSI
 15-25 PSI 33L

390mm
 905mm
 632mm

Esta máquina de chorreado de arena dispone de una gran ventana e iluminación en el interior para poder hacer trabajos que necesiten mucha precisión. Permite introducir piezas en su interior y tratarlas dentro, reduciendo la suciedad y el desperdicio abrasivo.

DESPIECE DISPONIBLE

52980 480,00€

45.00 - 1 4

MÁQUINA LIMPIADORA DE PIEZAS 150L

150L

MEDIDAS TOTALES MÁQUINA: 890mm x 1.090mm x 520mm
 MEDIDAS DEL INTERIORES DEPÓSITO: 270mm x 1.060mm x 490mm

Máquina limpiadora de piezas con depósito de 150L. Incluye una pistola de limpieza y un sistema de aspiración de residuos.

DESPIECE DISPONIBLE

50632 298,00€

24.20 - 1 6

MÁQUINA LIMPIADORA DE PIEZAS

100L

MEDIDAS TOTALES MÁQUINA: 890mm x 780mm x 540mm
 MEDIDAS DEL INTERIORES DEPÓSITO: 260mm x 725mm x 490mm

Máquina limpiadora de piezas con depósito de 100L. Incluye una pistola de limpieza y un sistema de aspiración de residuos.

DESPIECE DISPONIBLE

- Caudal: 25L.
 - Funciona con soluciones limpia motores solubles en agua.

- Caudal: 25L.
 - Funciona con soluciones limpia motores solubles en agua.

51837

195,00€



ASPIRADORA INDUSTRIAL 30L SECO

30L

Capacidad (l)	30
Litros de aspiración por segundo (l/s)	26
Potencia motores	1x1.200W
Voltaje	230V
Frecuencia	50Hz
Potencia de succión	> 17Kpa
Ø manguera	32mm
Largo manguera	1,5m
Largo cable	4,5m
Estanqueidad	IPx4



CONTIENE



DESPIECE DISPONIBLE

* Esta aspiradora tiene un sistema que permite un encendido automático si se conecta a una lijadora.

51838

667,00€



ASPIRADORA INDUSTRIAL 80L SECO+HÚMEDO

80L

Capacidad (l)	80
Litros de aspiración por segundo (l/s)	50
Potencia motores	3x1.000W
Voltaje	230V
Frecuencia	50Hz
Potencia de succión	> 20Kpa
Ø manguera	48mm
Largo manguera	2m
Largo cable	4,5m
Estanqueidad	IPx4



CONTIENE



DESPIECE DISPONIBLE

53947

145,00€



HIDROLIMPIADORA DE ALTA PRESIÓN 1400W

230V	1400W	MAX 105 Bar	MAX WATER 50°C	5,0Kg
MAX 6.0l/min	5m	3m	50 Hz	IP X5

CONTIENE



DESPIECE DISPONIBLE

- A PISTOLA ROCIADORA
- B CABLE DE ALIMENTACIÓN
- C SALIDA DE AGUA
- D MANGUERA DE ALTA PRESIÓN

53948

324,00€



HIDROLIMPIADORA DE ALTA PRESIÓN 2400W

230V	2400W	MAX 180 Bar	MAX WATER 50°C	10,0Kg
MAX 8.0l/min	5m	8m	50 Hz	IP X5

CONTIENE



DESPIECE DISPONIBLE

- A MANGUERA DE ALTA PRESIÓN
- B PISTOLA ROCIADORA
- C SALIDA DE AGUA
- D CABLE DE ALIMENTACIÓN

53189 128,00€

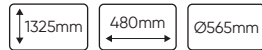
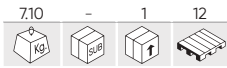

VENTILADOR DE PIE

230V / 120V 50 Hz



54125 152,00€

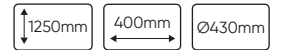
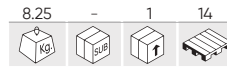

VENTILADOR PULVERIZADOR DE AGUA



DESPIECE DISPONIBLE



53543 13,80€

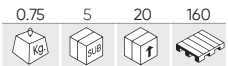

VENTILADOR PARA VEHÍCULO 12V



x2 VELOCIDADES



53190 98,00€



VENTILADOR DE SUELO

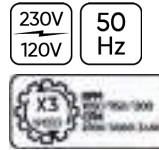

54229 48,00€



CALEFACTOR - 2KW



54229
54230

54230 68,00€



CALEFACTOR - 3KW



54231 138,00€



CALEFACTOR - 5KW



54231
54232

54232 248,00€



CALEFACTOR - 9KW



HERRAMIENTAS ELÉCTRICAS

52162

38,00€



TERMÓMETRO LÁSER -50° A 550°C



52450

105,00€

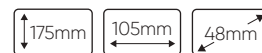
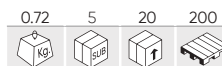

TERMÓMETRO LÁSER -50°C A 1000°C



53503

12,00€

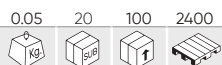

TERMÓMETRO DIGITAL DE CONTACTO



53585

168,00€



CARRETE DE CABLE ELÉCTRICO 21M - AZUL

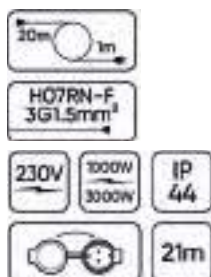

53586

168,00€



CARRETE DE CABLE ELÉCTRICO 21M - VERDE



REF. DESCRIPCIÓN

14771 SOPORTE DE PARED PARA CARRETES PARA REF. 53532/ 53581/ 53585/ 53586

0.35 - 30 - 10,50€

53584

119,00€

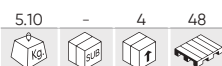

CARRETE DE CABLE ELÉCTRICO - 12M - VERDE



53526

119,00€



CARRETE DE CABLE ELÉCTRICO 12M - AZUL



REF. DESCRIPCIÓN

14774 SOPORTE DE PARED PARA CARRETES PARA REF. 53526/ 53584

0.40 - 10 - 10,50€

51831

24,00€

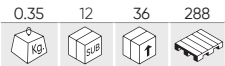

PISTOLA DE ADHESIVO TERMOFUSIBLE

- Voltaje: 100~ 230 V.
- Temperatura: 190~230 °C.
- Consumo: 60~150 W.
- Ø de boquilla: 2.0~2.3 mm.
- Rango: 8 - 16g de producto/min.



REF.	DESCRIPCIÓN					€
51859	BLISTER 10U ADHESIVO TERMOFUSIBLE PARA REF. 51831	0.12	8	32	1520	3,80€

51033

98,00€



CARRETE DE CABLE ELÉCTRICO



- Protección de sobrecarga.
- Protección infantil.



EXTENSIÓN DE CABLE DE CORRIENTE

REF.	m					€
53166	3m	0.45	5	30	600	10,50€
53167	5m	0.65	5	20	600	12,50€
53168	10m	1.20	-	10	300	19,00€



52643

596,00€

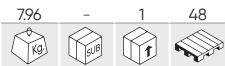

MÁQUINA PARA RALLAR NEUMÁTICOS

REGULABLE DIGITALMENTE

REF.	DESCRIPCIÓN				€
11974	RECAMBIO R1 PARA REF.52643	0.01	20	500	1,80€
11975	RECAMBIO R2 PARA REF.52643	0.01	20	500	1,80€
11976	RECAMBIO R3 PARA REF.52643	0.01	20	500	1,80€
11977	RECAMBIO R4 PARA REF.52643	0.01	20	500	1,80€
11978	RECAMBIO R5 PARA REF.52643	0.04	20	100	1,80€
11979	RECAMBIO W1 PARA REF.52643	0.04	20	500	1,80€
11980	RECAMBIO W2 PARA REF.52643	0.04	20	500	1,80€
11981	RECAMBIO W3 PARA REF.52643	0.01	20	500	1,80€
11982	RECAMBIO W4 PARA REF.52643	0.01	20	200	1,80€
11983	RECAMBIO W5 P/ MAQUINA DE RECAUCHUTAR (REF.52643)	0.04	20	500	1,80€



RECAMBIOS

REF.	11974	11975	11976	11977	11978
TIPO CUCHILLA	R1	R2	R3	R4	R5
CUCHILLA REDONDA	mm	mm	mm	mm	mm
	A 3	5	6	8	10
	B 7	7	10	12	12
	C 5	8	15	16	18
	D 21	21	23	25	24

REF.	11979	11980	11981	11982	11983
TIPO CUCHILLA	W1	W2	W3	W4	W5
CUCHILLA CUADRADA	mm	mm	mm	mm	mm
	A 3	5	7	9	11
	B 7	7	10	12	12
	C 5	6	10	13	15
	D 21	21	22	24	23

52598

1.080,00€



ROBOT CORTACÉSPED



Robot cortacésped moderno y funcional, perfecto para el cuidado y el mantenimiento de tu césped y de espacios verdes. Está equipado con un motor sin escobillas, alimentado por una potente batería de 5200 Ah, para una autonomía de 150 minutos aproximadamente. El plato de corte contiene tres cuchillas de acero que realizarán un corte mulching. Con este corte, la hierba depositada en el césped se descompondrá y se convertirá en nutriente para el suelo, creando un ciclo biológico totalmente natural. El cable perimetral y las estacas suministradas permiten una instalación sencilla y sin necesidad de herramientas.



CONEXIÓN APP



- A MOTOR BRUSHLESS
- B INTERRUPTOR STOP
- C ESTACIÓN DE CARGA
- D RUEDA TRASERA
- E TAPA DEL CONTROL

54252

199,00€



BARREDORA DE EMPUJE MANUAL

- A RECIPIENTE DE RECOGIDA DE SUCIEDAD
- B CUERPO PRINCIPAL
- C CEPILLO DE DISCO IZQUIERDO
- D CEPILLO DE DISCO DERECHO
- E TAPA SUPERIOR
- F MANILLAR SUPERIOR DE EMPUJE
- G MANILLAR INFERIOR DE EMPUJE
- H ASA DE TRANSPORTE



ENERGÍA RENOVABLE Y MOVILIDAD DEL FUTURO

342 CABLES DE CARGA DE COCHE ELÉCTRICO

342 CARGADORES DE COCHE ELÉCTRICO

343 GENERADOR DE ENERGÍA

344 HERRAMIENTAS AISLADAS



CABLES DE CARGA

TIPO 1-2 TYPE 1-2

REF.	DESCRIPCIÓN					€
54053	CABLE DE CARGA PARA COCHE ELÉCTRICO, 3,6KW, 16 A, TIPO 1 A TIPO 2 (MONOFÁSICO)	2.15	-	5	-	248,00€
54054	CABLE DE CARGA PARA COCHE ELÉCTRICO, 7,5KW, 32 A, TIPO 1 A TIPO 2 (MONOFÁSICO)	2.90	-	5	100	268,00€

-25°
+55°

Tipo
1-2

IP66

5m



TIPO 2-2 TYPE 2-2

REF.	DESCRIPCIÓN					€
54055	CABLE DE CARGA PARA COCHE ELÉCTRICO, 3,6KW, 16 A, TIPO 2 A TIPO 2 (MONOFÁSICO)	2.15	-	5	100	220,00€
54056	CABLE DE CARGA PARA COCHE ELÉCTRICO, 11KW, 16 A, TIPO 2 A TIPO 2 (TRIFÁSICO)	2.85	-	5	102	260,00€
54057	CABLE DE CARGA PARA COCHE ELÉCTRICO, 7,5KW, 32 A, TIPO 2 A TIPO 2 (MONOFÁSICO)	2.95	-	5	102	248,00€
54058	CABLE DE CARGA PARA COCHE ELÉCTRICO, 22KW, 32 A, TIPO 2 A TIPO 2 (TRIFÁSICO)	3.85	-	5	100	348,00€

-25°
+55°

Tipo
2-2

IP66

5m



CARGADORES DE PARED

REF.	DESCRIPCIÓN					€
52600	CARGADOR DE PARED 3.6 KW, 16 A, PARA COCHE ELÉCTRICO (MONOFÁSICO)	4.65	-	4	80	884,00€
52902	CARGADOR DE PARED 7.5 KW, 32 A, PARA COCHE ELÉCTRICO (MONOFÁSICO)	4.90	-	4	40	970,00€
52903	CARGADOR DE PARED 11 KW, 16 A, PARA COCHE ELÉCTRICO (TRIFÁSICO)	5.25	-	1	40	1.100,00€

295mm

195mm

65mm

IP66

-25°
+55°

Tipo
2



54265

1.290,00€

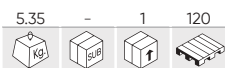

CARGADOR DE PARED 22 KW, 32 A, PARA COCHE ELÉCTRICO (TRIFÁSICO)



Trifásico
Three-Phase



Únete al futuro con nuestro sistema de carga rápida para tu coche eléctrico. Moderno y con un diseño minimalista, con el cargador de pared de JBM podrás transformar tu garaje, patio o estacionamiento de oficina en un lugar fácil de usar para tu EV / PHEV.

54059

428,00€



CARGADOR PORTÁTIL 16 A, CON CABLE DE CARGA TIPO 2



Con este cargador móvil podrás cargar tu vehículo donde quiera que estés, con una toma de corriente normal. Es una solución rápida y económica para cargar coches eléctricos en tu taller. Dispone de una pantalla LCD con acceso a los parámetros más importantes, cable tipo 2 integrado, diseño compacto, carcasa extremadamente duradera y 5m de longitud del cable total. Es garantía de comodidad de uso y confiabilidad.

REF.	DESCRIPCIÓN	kg	U	cm	€
16130	MEDIDOR DE CORRIENTE PARA CARGADOR (REF.54265)	0.40	-	15	290,00€
16198	TARJETA RFID (REF. 54265)	0.01	-	-	5,00€

REF.	DESCRIPCIÓN	kg	U	cm	€
15460	TARJETA RFID	0.01	-	250	5,00€

53970

3.790,00€

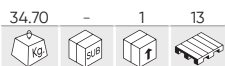

ESTACIÓN DE ENERGÍA PORTÁTIL 1920WH/48V 40AH

MPPT	CC-CA	2W(x2) LED	200WAC ±10%	Carga rápida Fast Charging 54V/10A 3-4H	Carga solar Solar Charging 54V/7.5A 4-5H
50-60 Hz	UNIVERSAL	12V 15A			
3000W	Salida nominal de CA Rated AC output	1920Wh LiFePO4			
5000W	Pico de salida de CA Peak AC output	x2000	Ciclos de carga Battery life cycles		
USB-DC 5V W/ 2A/3A	DC/DC 12V/10A	Temperatura de descarga Discharging Temperature -10°C/60°C	Temperatura de carga Temperature 0°C/45°C		
USB-5V4-C 2A/3A - 4A/2A 5V/2.4A	USB 5V 2.4A/2				

La central eléctrica portátil es un generador eléctrico de gran capacidad que se recarga con energía solar, pero también puede recargarse en cualquier toma de corriente, en ausencia de luz solar.

- CONTIENE
- CARGADOR DE BATERÍA
 - CARGADOR PLACA SOLAR
 - CABLE CONECTOR CARGADOR DE PARED

COMPATIBLE CON
54321



54321

898,00€



PANEL SOLAR 200W PARA REF.53970

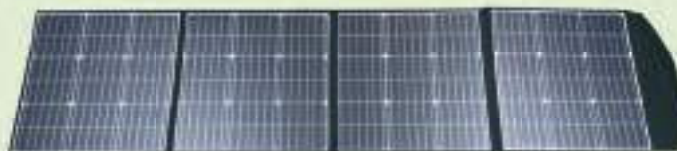
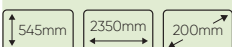

REF.	DESCRIPCIÓN	kg	U	cm	€
15448	SET DE 2 CONECTORES MC4 1000V 30A	0.01	-	186	5,50€

53940

13,20€



POSTE DE PLÁSTICO PARA CADENA - AMARILLO/NEGRO

- De PVC.
- Franjas amarillas y negras.
- Base rellenable de agua o arena.

CADENA NO INCLUIDA.



ESPECIAL SEÑALIZACIÓN ALTA TENSION



54326

7,30€



N

CADENA DE PLÁSTICO AMARILLA / NEGRA 7m



53987

9,50€



CINTA DE BALIZAMIENTO 200M - AMARILLA / NEGRA



53942

0,50€

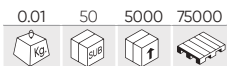

ESLABÓN DE ENCAJE NEGRO



54322

19,00€

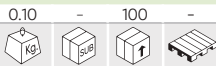

N

SET DE 2 CARTELES DE ADVERTENCIA ALTO VOLTAJE



52382

19,50€

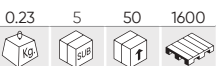

PINZA AMPERIMÉTRICA

DCB	600V
ACB	600V
DCA	-
ACA	20A, 200A, 600A
OHM	2KΩ, 200KΩ, 2MΩ



52952

74,00€



PINZA AMPERIMÉTRICA

DCB	20V, 600V
ACB	600V
DCA	200A
ACA	200A
OHM	2000Ω



50942

28,00€

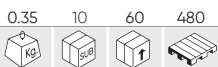

MULTÍMETRO DIGITAL

- Indicador de batería.
- Baterías de 9V.
- Sonda de temperatura.
- Temperatura de -40°C a 1000°C.
- Datos instantáneos.
- Autoapagado.



54091

441,00€



MALETÍN DE HERRAMIENTAS AISLADAS VDE 26 PCS

26PCS
3/8"
CrV
VDE
GS: Geprüfte Sicherheit
1000V
IEC 60900C



54093

441,00€



MÓDULO EVA DE HERRAMIENTAS AISLADAS VDE 26 PCS

26PCS
3/8"
CrV
VDE
GS: Geprüfte Sicherheit
1000V
IEC 60900C



53154

462,00€



MALETÍN DE HERRAMIENTAS AISLADAS 20 PCS DE 3/8"

20PCS
3/8"
CrV
VDE
GS: Geprüfte Sicherheit
1000V
IEC 60900C



15162

30,20€



SET DE 8 DESTORNILLADORES AISLADOS VDE EN MÓDULO EVA FIBRA DE CARBONO

8PCS
VDE
GS: Geprüfte Sicherheit
1000V
IEC 60900C

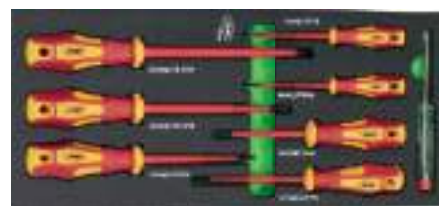

52519

25,50€

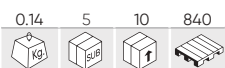

SET DE 7 DESTORNILLADORES AISLADOS 1.000V

7PCS
CrV
VDE
GS: Geprüfte Sicherheit
1000V
IEC 60900:2004

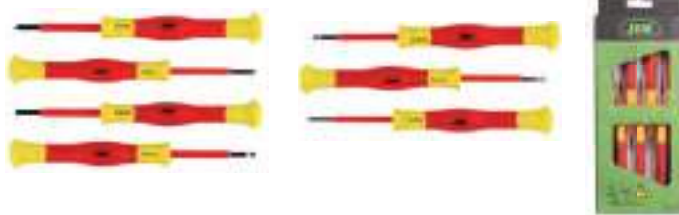

GUANTES AISLANTES PARA TRABAJOS EN TENSIÓN

REF.	DESCRIPCIÓN					€
54130	T.9	0.35	-	1	100	58,00€
54131	T.10	0.40	-	1	100	58,00€

AZC
LATEX
CAT III
CLASS 0
1000V AC / 1500V DC
IEC ELECTRICAL SAFETY
GLOVES 60903-2014 CLASS 0



CUCHILLOS AISLADOS

REF.	DESCRIPCIÓN					€
53164	RECTO	0.10	6	36	1152	16,50€
53165	CURVADO	0.10	6	36	1152	19,60€

CrV
VDE
GS: Geprüfte Sicherheit
1000V
IEC 60900C



CARRO DE HERRAMIENTAS 7 CAJONES - ESPECIAL VEHÍCULO ELÉCTRICO

54236 1.856,00€

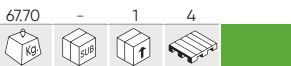

54233 1.856,00€

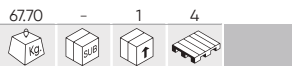

54234 1.856,00€

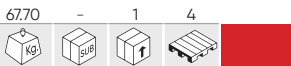

54235 1.856,00€

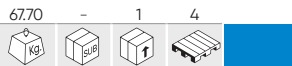

CONTIENE

REF.	UNI.	€	REF.	UNI.	€	REF.	UNI.	€			
A	52162	1	38,00€	E	54093	1	441,00€	I	54132	1	190,00€
B	53940	4	13,20€	F	54114	1	248,00€	J	54241	1	120,00€
C	54326	1	7,30€	G	54129	1	110,00€				
D	53942	8	0,50€	H	54130	1	58,00€				

54386

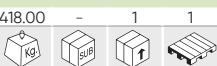

MESA HIDRÁULICA PARA BATERÍAS DE VEHÍCULOS ELÉCTRICOS

Características de carga	Carga distribuida
Tiempo de elevación (sin carga)	60"
Tiempo de descenso (sin carga)	45"
Plataforma	1290 - 1400x768mm



5.839,00€

1840mm 770mm 650mm

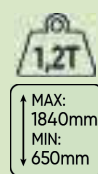

54241

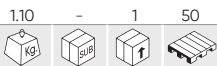

120,00€



PÉRTIGA DE SALVAMENTO AISLADA - 45KV



54129



110,00€



ALFOMBRA AISLANTE CLASE 0

- CLASS 0
- ENROLLABLE ROLLS
- SLIP RESISTANT
- OIL RESISTANT
- RECYCLABLE
- 1000V AC / 1500V DC
- IEC ELECTRICAL SAFETY
- MATting 60903-2024 CLASS 0



54132

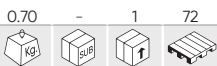

190,00€

PANTALLA FACIAL AISLANTE PARA TRABAJOS EN TENSION

- ANTI-RALLADURAS / SCRACHING PROOF
- ANTI-VAHO / ANTI FOG
- EN 170:2022
- EN 166:2001
- ANSI Z87.1
- CLASS 1



54114

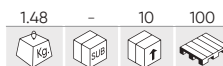

248,00€

MEDIDOR DE AISLAMIENTO

- 2000MΩ
- 1000V
- 750V
- CAT III

CON MULTÍMETRO



ACCESORIOS DE TALLER

348 CARRETES

349 ESCALERAS

350 CARROS Y PLATAFORMAS



CARRETE DE MANGUERA DE AIRE

REF.	m					€
53582	22m 10.85	-	1	14		174,00€
53583	22m 10.75	-	1	14		174,00€
53532	13m 6.60	-	2	30		119,00€
53581	13m 6.70	-	2	30		119,00€
53881	11m 4.50	-	4	48		79,00€
53882	11m 4.50	-	4	48		79,00€

300 PSI
20 BAR

3/8"

Ø 9.5mm



CON REPARTIDOR

CARRETE DE MANGUERA DE AGUA

REF.	m					€
53872	16,5m 7.50	-	1	21		118,00€

15m + 1,5m

120 PSI
8 BAR

3/4"

PVC



CARRETE DE CABLE ELÉCTRICO

REF.	m					€
53586	21m 8.35	-	2	30		168,00€
53585	21m 8.35	-	2	36		168,00€
53584	12m 5.10	-	4	48		119,00€
53526	12m 5.15	-	4	48		119,00€

230V

1000W
3000W

IP44

H07RN-F
3G1.5mm²



CON REPARTIDOR



CARRETE DE MANGUERA PARA ACEITE BOCA DE 1/2"

REF.	m					€
50797	16m	26.60	-	1	14	490,00€

- Carrete para tubo de aceite.
- Longitud de la manguera: 15+1 m.
- Presión máxima de trabajo: 2450 PSI.
- Entrada: 1/2" BSPT.
- Salida: 1/2" BSPT.
- Material: Acero.



160 BAR



ESCALERA TELESCÓPICA

REF.	DESCRIPCIÓN					€
51982	ESCALERA TELESCÓPICA 6 PASOS	5.51	-	1	34	120,00€
51983	ESCALERA TELESCÓPICA 10 PASOS	9.41	-	1	34	185,00€
51984	ESCALERA TELESCÓPICA 12 PASOS	9.78	-	1	22	190,00€

CUMPLE CON: EN 131



↑ 2.000mm
↓ 730mm

51982



↑ 3.200mm
↓ 930mm

51983



↑ 3.800mm
↓ 1.020mm

51984

52149

14.00	-	1	14

230,00€

CUMPLE CON: EN 131

ESCALERA TELESCÓPICA EN V PLEGABLE

- Escalera plegable y ligera.
- Sistema de plegado mediante bloqueo.
- Fabricada en aluminio y plástico.
- Altura plegada: 835mm.
- Altura extendida: 3800mm.
- Altura total: 1900mm.



54176

188,00€

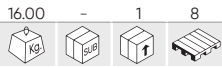

CUMPLE CON: EN 131

ESCALERA MULTIPOSICIÓN

- Longitud máxima: 3,7m
- Capacidad: 150kg
- Material: Aluminio
- Espesor de aluminio: 1,2mm
- Espacio entre dos peldaños: 28cm

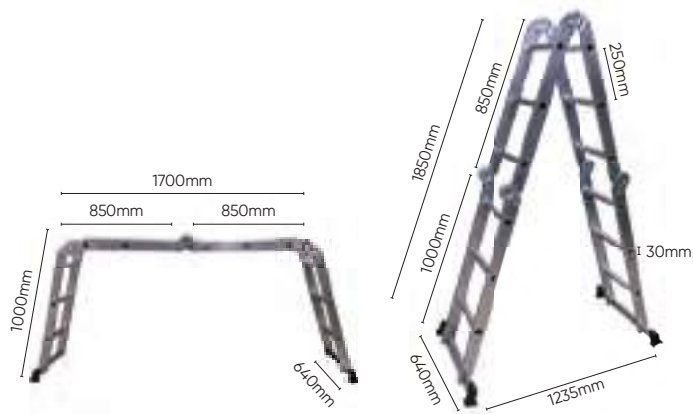

CONTIENE

REF. DESCRIPCIÓN

15866	SET DE DOS PLATAFORMAS (REF.54176)	5.00	-	1	-	32,00€
-------	------------------------------------	------	---	---	---	--------

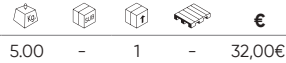

50517

129,00€

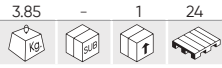

ESCALERA DE ALUMINIO CON 4 PELDAÑOS

- 4 PELDAÑOS
- Altura total: 1,30m.
 - Altura máx. trabajo: 0,79m.



50518

169,00€

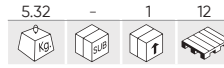

ESCALERA DE ALUMINIO CON 6 PELDAÑOS

- 6 PELDAÑOS
- Altura total: 1,91m.
 - Altura máx. trabajo: 1,31m.



52230

398,00€

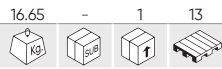

CUMPLE CON: EN 131

PLATAFORMA DE ALUMINIO TELESCÓPICA



MIN	MAX
520mm	900mm
1090mm	1750mm
300mm	300mm

REF. DESCRIPCIÓN

10964	PROTECTOR DE ESQUINA PARA PLATAFORMA (REF.52230)	0.01	-	1	-	9,00€
10965	TOPE DE ESCALÓN PARA PLATAFORMA (REF. 52230)	0.01	-	1	-	6,00€
10966	PIE RECAMBIO PARA PLATAFORMA (REF.52230)	0.06	-	1	-	13,50€



50656

290,00€

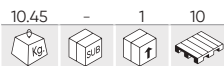

CUMPLE CON: EN 131

JUEGO DE 2 PLATAFORMAS DE ALUMINIO



REF.	cm					€
11897	100x30x30cm	4.66	-	1	16	155,00€
15552	130x30x55cm	6.80	-	1	18	181,00€

50913

195,00€

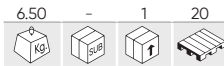

CUMPLE CON: EN 131

PLATAFORMA DE ALUMINIO GRANDE



52202

88,00€



CARRO DE ACERO BÁSICO



REF.	DESCRIPCIÓN					€
12055	RUEDA	1.11	10	160	20,00€	



50924

342,00€



CARRO PORTA BIDONES ESPECIAL ENGRASE



52200

88,00€

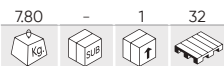

CARRO PLEGABLE CON PLATAFORMA DE ACERO 150KG



EXTENDIDO	PLEGADO
840mm	230mm
725mm	390mm
475mm	475mm



54305

232,50€



N

CARRO PLEGABLE CON PLATAFORMA DE ALUMINIO 300KG

EXTENDIDO	PLEGADO
895mm	330mm
610mm	610mm
900mm	900mm



54308

89,00€



N

CARRETILLA DE ALUMINIO 90KG



EXTENDIDO



PLEGADO

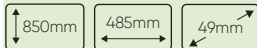

54310

57,00€



N

CARRETILLA PLEGABLE DE ALUMINIO 75KG



EXTENDIDO

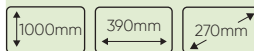

PLEGADO



54306

219,50€



N

CARRETILLA PLEGABLE DE ALUMINIO 250KG



EXTENDIDO

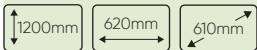

PLEGADO



54309

71,00€



N

CARRETILLA PLEGABLE SUBE ESCALERAS



EXTENDIDO

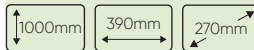

PLEGADO



ACCESORIOS PARA VEHÍCULOS

- 354 SEÑALIZACIÓN
- 355 KITS DE EMERGENCIA
- 357 BOMBILLAS
- 358 BOTIQUINES
- 359 SEGURIDAD
- 359 FUELLES Y ABRAZADERAS
- 361 ALFOMBRAS
- 362 ESCOBILLAS
- 363 BICICLETA
- 364 OTROS
- 366 SENSORES DE PARKING
- 366 TUBOS FLEXIBLES



ACCESORIOS PARA VEHÍCULOS

53778

4,50€



TRIÁNGULO DE EMERGENCIA INDIVIDUAL 27R032736



CUMPLE CON: E4 27R-032736

52795

5,80€



TRIÁNGULO DE EMERGENCIA 27R 032738



CUMPLE CON: E4 27R-032738

54298

7,50€



SET DE 2 TRIÁNGULOS DE EMERGENCIA 27R032736 (1 UNIDAD = 2 TRIÁNGULO)

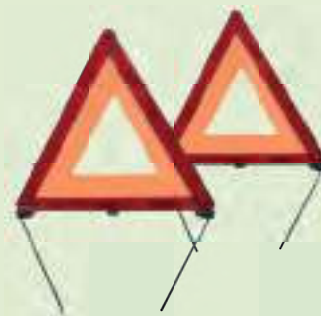

CUMPLE CON: E4 27R-032736

N

CHALECO REFLECTANTE HOMOLOGADO

CUMPLE CON: EN ISO20471:2013

+A1:2016

51817

4,50€

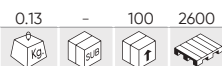

Banda marcada

50654

4,00€



50966

4,00€



50966C

3,00€

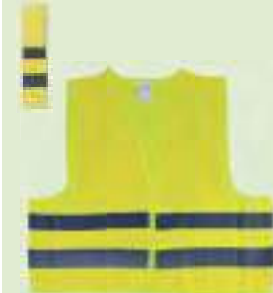

N

DISTINTIVO PARA VEHÍCULOS DE TRANSPORTE DE MERCANCÍAS

REF.					€
51935		1.04	10	280	135,00€
51936		1.04	10	140	135,00€
51937		1.02	10	280	135,00€

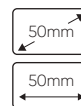

Homologación: REGLAMENTO CEPE/ONU 104R

- Aplicación a partir del 10 de Julio de 2011 según modificación del Reglamento General de Vehículos, aprobado por el Real Decreto 2822/1998, de 23 Dic. de 2010.
- Bobinas indivisibles de 50m

PLACA PARA CARGA SOBRESALIENTE HOMOLOGADA V.20

REF.					€
53636	FABRICADA EN POLIPROPILENO PARA UNA MAYOR FLEXIBILIDAD	0.87	25	700	22,00€
53507	PORTE DELANTERA DE POLIMETILMETRACRILATO Y PARTE TRASERA DE ALUMINIO	0.75	25	800	27,00€



KITS DE EMERGENCIA Y SEGURIDAD

BOLSA CON RIBETE

REF.						€
51692	550x90x130mm	0.11	-	100	1600	3,55€
51693	550x90x130mm	0.12	-	100	1200	3,55€
51694	550x90x130mm	0.14	-	100	1200	3,55€
51696	550x90x130mm	0.12	-	80	1200	3,55€



BOLSA NEGRA CON RIBETE

REF.						€
11328	557x110x70mm	0.12	-	100	1200	4,00€



53721 18,80€

0.16	20	80	1440

BALIZA DE EMERGENCIA LED



KIT DE EMERGENCIA - BOLSA DE PVC

REF.							€
53185	x1	0.69	-	10	200	13,20€	
53186	x2	1.04	-	10	200	13,20€	

* Doble triángulo, obligatorio solo en España.

CONSULTE PRECIO POR CANTIDADES
SERIGRAFÍA Y FOTOLITO NO INCLUIDOS

BOLSA PLANA

REF.						€
53621	550x150mm	0.05	-	100	3200	2,50€
53622	550x150mm	0.05	-	100	3200	2,50€
53623	550x150mm	0.05	-	100	3200	2,50€
53624	550x150mm	0.05	-	100	3200	2,50€



BOLSA NYLON NEGRA

REF.						€
15619	330x100x80mm	0.09	-	100	1500	4,00€



KIT DE EMERGENCIA - BALIZA Y CHALECO

REF.						€
54534	330x100x80mm	0.37	-	10	200	24,00€



KIT DE EMERGENCIA

REF.		△					€	
52768	■	x2	MK H1	1.81	-	10	200	13,80€
52772	■	x2	MK H1	1.88	-	10	200	13,90€
52776	■	x2	MK H1	1.81	-	10	200	13,80€
52780	■	x2	MK H1	1.94	-	10	200	13,90€
52769	■	x2	MK H4	1.01	-	10	200	14,50€
52773	■	x2	MK H4	1.01	-	10	200	14,60€
52777	■	x2	MK H4	1.07	-	10	200	15,50€
52781	■	x2	MK H4	1.14	-	10	200	14,60€
52770	■	x2	MK H7	2.55	-	10	200	23,00€
52774	■	x2	MK H7	0.99	-	10	200	14,80€
52778	■	x2	MK H7	0.99	-	10	200	14,60€
52782	■	x2	MK H7	1.11	-	10	200	14,80€
52771	■	x2	MK H7+H1	2.75	-	10	200	23,40€
52775	■	x2	MK H7+H1	1.01	-	10	200	15,20€
52779	■	x2	MK H7+H1	1.13	-	10	200	17,10€
52783	■	x2	MK H7+H1	1.01	-	10	200	15,20€



* Doble triángulo, obligatorio solo en España.

KIT DE EMERGENCIA - BOLSA CON RIBETE

REF.		△					€
53177	■	x1	0.63	-	10	200	11,90€
53178	■	x1	0.64	-	10	200	12,20€
53179	■	x1	0.65	-	10	200	12,20€
53180	■	x1	0.63	-	10	200	12,20€
53181	■	x2	0.98	-	10	200	11,90€
53182	■	x2	0.99	-	10	200	12,20€
53183	■	x2	0.99	-	10	200	12,70€
53184	■	x2	0.98	-	10	200	12,20€



* Doble triángulo, obligatorio solo en España.

KIT DE EMERGENCIA - BOLSA CON RIBETE

REF.		△					€
53087	■	x1	0.58	-	10	200	11,20€
53088	■	x1	0.59	-	10	200	11,50€
53089	■	x1	0.61	-	10	200	11,50€
53090	■	x1	0.59	-	10	200	11,50€



KIT DE EMERGENCIA - BOLSA PLANA

REF.		△					€
53091	■	x1	0.52	-	10	200	10,20€
53092	■	x1	0.52	-	10	200	10,20€
53093	■	x1	0.52	-	10	200	10,20€
53094	■	x1	0.52	-	10	200	10,20€



MINI ESTUCHES DE BOMBILLAS

REF.								€
51613	12V	H1	0.90	10	100	1500		2,90€
51615	12V	H9	0.09	10	100	1500		5,95€
51612	12V	H11	0.09	10	100	1500		5,95€
50523	12V	HB3	0.09	10	100	1500		4,70€
50524	12V	HB4	0.09	10	100	1500		4,70€
50915	12V	H7+H1	0.10	10	100	1800		4,20€
51614	12V	H4	0.10	10	100	1800		3,60€
50431	12V	H7	0.08	10	100	1800		3,80€
52047	24V	H4	0.09	10	100	1500		3,30€
52048	24V	H7	0.10	10	100	1500		3,95€



50551 350,00€

ARMARIO DE LÁMPARAS PARA TURISMO

STOP DE 1 POLO

P21W 21 W BA15S 30U.
P21WA 21 W BA15S AMBAR / 10U.
PY21W 21 W BAU15S
CON DESC. / 10U.

STOP DE 2 POLOS

R21/5 W 21/5 W BAY15D 40U.
PLAFONIER
C5W 5 W SV8.5 11X38 22U.

LÁMPARAS PILOTO

R5W 5 W BA15S 30U.
R10W 10 W BA15S 30U.

LÁMPARAS INDICADORAS

T4W 4 W BA9S 22U.

LÁMPARAS HALÓGENAS

H1 55 W P14.5S 10U.
H2 55 W X511 4U.
H3 55 W PK22S 4U.
H4 60/55 W P43T 10U.
H7 55 W PX26D 10U.
HB3 65 W P20D 4U.
HB4 55 W P20D 4U.
H9 65 W PGJ19-5 4U.
H11 65 W PGJ19-2 4U.

FOCO EUROPEO

T5 1,2 W W2,1X4,6D 20U.
T10 5 W W2.1X9,6D 12U.
T10 3 W W2.1X9,6D 12U.
T13 10 W W2.1X9,6D 10U.
T15 18 W W2.1X9,6D 10U.
T20 21 W W5X16D 10U.
T20A 21 W W5X16D AMBAR 10U.
T20 21/5 W W5X16D 10U.



BOMBILLAS OBN

REF.	DESCRIPCIÓN						€
52365	LÁMPARA OBN H7 55W	0.02	10	200	9000		2,46€
52364	LÁMPARA OBN H1	0.02	10	200	4400		2,86€
52362	LÁMPARA OBN H1	0.01	10	200	14400		1,23€
10766	LÁMPARA DE RECAMBIO PARA REF.51960/51962	0.01	-	200	-		1,59€
52363	LÁMPARA OBN H3	0.02	10	200	14400		1,23€
53203	LÁMPARA OBN AMBAR 12V 21W BA15S	0.01	10	200	-		0,46€
52369	LÁMPARA OBN 12V 2 POLOS	0.01	10	1000	18000		1,19€
52368	LÁMPARA OBN 12V SIN CASQUILLO T20A	0.01	10	1000	18000		1,14€
53007	LÁMPARA OBN R5W 12W 5V	0.05	10	200	1500		0,42€
52862	LÁMPARA OBN WEDGE 21W 12V T20	0.01	10	1000	1500		1,15€
52370	LÁMPARA OBN 12V SIN CASQUILLO T20 AMBAR	0.01	10	1000	18000		1,17€
52864	LÁMPARA OBN WEDGE 21/5W 12V T20	0.01	10	500	1500		1,20€
52865	LÁMPARA OBN WEDGE 10W 12V T13	0.01	10	2000	-		0,50€
52866	LÁMPARA OBN WEDGE 18W 12V T15	0.01	10	2000	256000		0,25€



54042



13,00€

44
PCS

BOTIQUÍN DE PRIMEROS AUXILIOS DIN13164:2022

- x1 Esparadrappo en bobina DIN 13019-A 5x2,5
- x4 Vendas adhesivas DIN 13019-E 10x6
- x2 Tiritas para dedos elásticas 4cmx7cm
- x2 Tiritas para dedos elásticas 12cmx2cm
- x2 Tiritas resistentes al agua 1.9x7.2cm
- x4 Tiritas resistentes al agua 2.5x7.2cm
- x1 Venda esterilizada DIN 13151-K 6x8cm
- x2 Vendas esterilizadas DIN 13151-M 8x10cm
- x1 Venda esterilizada DIN 13151-G 10x12cm
- x1 Paño para heridas DIN 13152-BR 60x40cm
- x1 Paño para heridas DIN 13152-A 60x80cm
- x2 Vendas esterilizadas DIN 61634FB6 6cmx400cm
- x3 Vendas esterilizadas DIN 61634FB8 8cmx400cm
- x1 Manta de primeros auxilios 160x210cm



- x6 Compresas esterilizadas 10x10cm
- x2 Vendajes triangulares DIN 13168-D
- x1 Tijera DIN 58279-A145 145cm
- x4 Guantes desechables DIN EN 455-1
- x2 Toallitas limpiadoras para limpiar la piel
- x1 Listado de contenido
- x1 Guía de primeros auxilios

51246



6,40€

11
PCS

BOTIQUÍN DE PRIMEROS AUXILIOS

- x1 Folleto primeros auxilios
- x1 Tijeras
- x1 Par de guantes
- x2 Toallitas de alcohol
- x2 Tiritas adhesivas
- x1 25g de algodón
- x1 Sobre con 5 gasas
- x1 Venda
- x1 Rollo de esparadrappo



54072

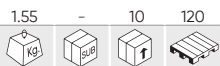

38,50€

67
PCS

BOTIQUÍN DE PRIMEROS AUXILIOS DIN13157

- x1 Esparadrappo adhesivo 5x25 - DIN13019-A
- x1 Set de vendas de esparadrappo 10x6cm (8 piezas) - DIN13019-E
- x6 Esparadrappo para dedos 4cmx6.5cm
- x6 Esparadrappo para dedos 120x20mm
- x6 Esparadrappo para dedos 7,2cmx1,9cm
- x12 Esparadrappo para dedos 25x72 mm
- x1 Vendas de primeros auxilios, compresa estéril 6x8cm - DIN13151-K
- x3 Vendas de primeros auxilios, compresa estéril 8x10cm - DIN13151-M
- x1 Vendas de primeros auxilios, compresa estéril 10x12cm - DIN13151-G
- x1 Apósitos para quemaduras 60x80cm - DIN13152-A
- x3 Apósitos estériles para heridas 100mm x100mm 2pcs/bolsa - DIN58953-2
- x2 Compresa ocular - 55mmx75mm 1.5g
- x1 Compresa fría instantánea 200cm2
- x1 Manta de primeros auxilios 160cmx210cm 12 micras
- x2 Vendajes elásticos en cumplimiento del estándar 6cmx400cm - DIN61634 FB6
- x2 Vendajes elásticos en cumplimiento del estándar 8cmx400cm - DIN61634 FB8
- x2 Vendas triangulares 96x96x136cm DIN13168-D
- x1 Tijeras de metal 190mm - DIN58279-B190
- x2 Bolsa de plástico para basura 300x400mm 45 micras
- x5 Malla no tejida 20cmX30cm min.15g/m2
- x1 Guantes desechables PVC L-AQL1.5 (juego de 4 piezas) - DIN EN 455-1



- x1 Folleto informativo
- x2 Mascarillas quirúrgicas DIN EN 14683
- x4 Toallitas de limpieza para piel sana

50644 11,60€

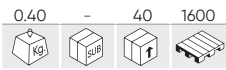

CINTURÓN DE SEGURIDAD DE 2 PUNTOS PARA AUTOCARES



CUMPLE CON: E4-16R-0436213

50717 21,90€

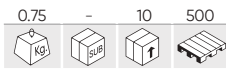

CINTURÓN DE SEGURIDAD DE 2 PUNTOS ENROLLABLE PARA AUTOCARES



CUMPLE CON: E4-16R-0436232

51266 28,00€

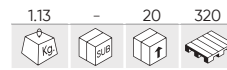

CINTURÓN DE SEGURIDAD 3 PUNTOS ENROLLABLE PARA AUTOCARES



CUMPLE CON: E4-16R-0436232

52259 3,75€

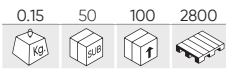

MARTILLO ROMPELUNAS CON SOPORTE Y CORTA-CINTURÓN

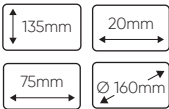

51861 199,00€

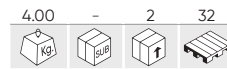

HERRAMIENTA NEUMÁTICA PARA EL MONTAJE DE FUELLES DE PALIER



- Material: Aluminio.
- Apertura de 20 a 100mm.

ABRAZADERAS

REF.	DESCRIPCIÓN					€
11890	ABRAZADERA PARA FUELLE 50-125MM	0.01	100	1000	18000	0,55€
11891	ABRAZADERA PARA FUELLE 15-45MM	0.01	100	5000	90000	0,50€
52633	PACK DE 2 PCS DE ABRAZADERAS	0.02	100	800	14400	1,00€



KIT DE FUELLE DE PALIER UNIVERSAL

REF.	DESCRIPCIÓN				€
51703	KIT DE FUELLE PALIER UNIVERSAL NEOPRENO - P/FURGONETA	0.28	20	320	10,50€
51705	KIT DE FUELLE DE PALIER UNIVERSAL NEOPRENO - P/TURISMO	0.23	20	400	8,45€



52644



KIT FUELLE DIRECCIÓN UNIVERSAL



8,80€

53693

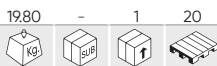

CAJA DE 100 KITS DE FUELLE

521,00€



x100 52633

x100 13738

x100 13879

53698



CAJA DE 100 KITS DE FUELLE DE PALIER PARA FURGONETA

717,00€



x100 52633

x100 13739

x100 13880

53695

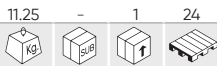

CAJA DE 80 KITS DE FUELLE DE DIRECCIÓN

504,00€



x80 52633

x80 13740

x80 13880

SERIE124



SERIE PROMOCIONAL ESPECIAL FUELLES

710,00€



x1 51861

x100 52633

x100 13738

x100 13879

RECAMBIOS

REF.	DESCRIPCIÓN	Kg	QTY	PALLET	€
13738	FUELLE DE PALIER PARA TURISMO UNIVERSAL	0.08	-	150 1800	3,50€
13739	FUELLE DE PALIER PARA FURGONETA UNIVERSAL	0.15	-	100 1600	5,50€
13740	FUELLE DE PALIER PARA DIRECCIÓN UNIVERSAL	0.10	-	72 -	5,50€
13879	BOLSA DE GRASA PARA FUELLE DE TRANSMISIÓN	0.09	-	150 5250	1,38€
13880	BOLSA DE GRASA PARA FUELLE DE DIRECCIÓN	0.01	-	600 21000	1,50€

50585

14,70€



ALFOMBRA DE GOMA UNIVERSAL REVERSIBLE

- Goma de alta calidad.
- Muy resistente.
- Adaptable a la mayoría de vehículos.



¡REVERSIBLE!



53241

9,00€

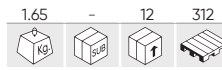

ALFOMBRA DE GOMA UNIVERSAL 4 PCS

- Goma de alta calidad.
- Muy resistente.
- Adaptable a la mayoría de vehículos.



52534

15,00€

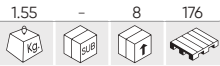

JUEGO DE ALFOMBRAS DE MOQUETA - TALONERA PLÁSTICA

REVERSO



- 2 Delanteras (425x660mm).
- 2 Traseras (295x425mm).
- Ligera, cómoda, con talonera plástica.
- Reverso con tacos de goma antideslizante.

52535

16,50€



JUEGO DE ALFOMBRAS DE MOQUETA - TALONERA MOQUETA

REVERSO



- 2 Delanteras (425x660mm).
- 2 Traseras (295x425mm).
- Ligera, cómoda, con talonera plástica.
- Reverso con tacos de goma antideslizante.

52530

14,00€



JUEGO DE ALFOMBRAS DE MOQUETA

- 2 Delanteras (390mm).
- 2 Traseras (365x480mm).
- Ligera, cómoda, con talonera plástica.
- Reverso con tacos de goma antideslizante.

REVERSO



METEXP

62,00€

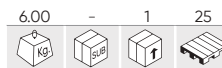

EXPOSITOR DE ALFOMBRAS JBM



ESCOBILLAS LIMPIAPARABRISAS



99%

Fácil instalación de los adaptadores en más del 99% de los vehículos y gran poder limpiador a alta velocidad.

38dB

La ergonomía y la eliminación de partes de peso reduce el ruido en 38db.

30%

Presión uniforme a largo de la escobilla gracias al muelle de acero para una mayor visibilidad que las escobillas originales y un rendimiento superior del 30%.

100%

Caucho 100% natural resistente a todas las condiciones climáticas extremas.

160km/h

Diseño aerodinámico que permite un uso hasta 160km/h.

45°

45° de ángulo de corte y precisión de limpieza transversal que elimina las gotas más pequeñas.

REF.	"	mm					€
53745	11"	280mm	0.20	10	50	800	6,40€
53746	12"	310mm	0.20	10	50	800	6,40€
53747	13"	330mm	0.20	10	50	900	6,40€
53748	14"	350mm	0.20	10	50	800	6,60€
53749	15"	380mm	0.20	10	50	900	6,70€
53750	16"	410mm	0.20	10	50	900	6,70€
53751	17"	430mm	0.20	10	50	900	6,80€
53752	18"	460mm	0.25	10	50	800	6,95€
53753	19"	480mm	0.25	10	50	700	7,10€
53754	20"	510mm	0.25	10	50	900	7,40€
53755	21"	530mm	0.25	10	50	600	7,50€
53756	22"	560mm	0.25	10	50	600	7,90€
53757	24"	610mm	0.25	10	50	600	7,90€
53758	26"	650mm	0.30	10	50	600	8,20€
53759	28"	700mm	0.30	10	50	550	8,50€
53760	30"	750mm	0.30	10	50	500	9,60€

11 ADAPTADORES DIFERENTES: PARA APLICACIONES MÚLTIPLES



12 PCS

JBMWBEXP

24,50€

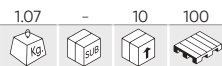

EXPOSITOR DE ESCOBILLAS LIMPIAPARABRISAS OBN



53919

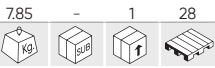

81,00€



SOPORTE DE REPARACIÓN DE BICICLETAS

- Material: Acero Q195, ABS, nylon
- Dimensiones montado: 190x104cm
- Altura ajustable: 107-188cm
- Longitud del tubo transversal giratorio: 37 cm
- Diámetro del tubo transversal giratorio: 35mm
- Diámetro del tubo telescópico: 35mm
- Diámetro del tubo principal: 38mm
- Diámetro del tubo de las patas: 25mm
- Peso máximo de carga: 30 kg

HECHA DE MATERIAL ABS REFORZADO Y NYLON PARA GIRAR LA BICICLETA A CUALQUIER ÁNGULO Y NO DAÑAR LA PINTURA.

CON BANDEJA DE HERRAMIENTAS DE PP MULTIFUNCIONAL 25X13CM

4 PATAS CON DISEÑO ANTIDESLIZANTE



PARA TODO TIPO DE BICICLETA
Ciudad / carretera / bicicleta de montaña



Barra ajustable de fijación: 50-90cm

54166

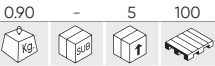

32,40€

BOMBA DE PIE PARA BICICLETA



54170

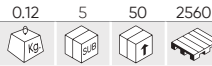

16,50€

BOMBA DE MANO PARA BICICLETA



54073



70,00€

ESTUCHE DE HERRAMIENTAS PARA REPARACIÓN DE BICICLETA 20 PCS



54074

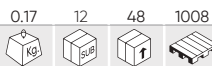

18,50€

HERRAMIENTA MULTIFUNCIÓN PARA REPARACIÓN DE BICICLETAS



54169

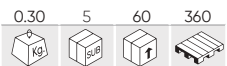

13,80€

CANDADO DE COMBINACIÓN PARA BICICLETA



ACCESORIOS PARA VEHÍCULOS

51858 15,00€



PALA PLEGABLE

- Fabricada con metal resistente.
- Plegada: 240mm.
- Desplegada: 580mm.



53033 21,50€



PALA EXTENSIBLE DE ALUMINIO

- Fabricada con plástico y aluminio.
- Plegada: 85mm.
- Desplegada: 119mm.



52187 21,80€



PALA METÁLICA 215MM



52251 21,80€

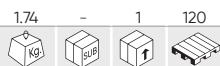

PALA METÁLICA CUADRADA 215MM



53964 9,65€



CUERDA MULTIUSOS 30M 1/4"

ø 1/4"
550Kg



53965 25,80€



CUERDA MULTIUSOS 30M 1/2"

ø 1/2"
1200Kg



51412 2,10€



PLACA PORTAMATRÍCULA ANÓNIMA

- Dimensiones: 53,20cm x 13,70cm.
- Área de marcado: 52cm x 1,60cm.

FOTOLITO Y SERIGRAFÍA NO INCLUIDO.

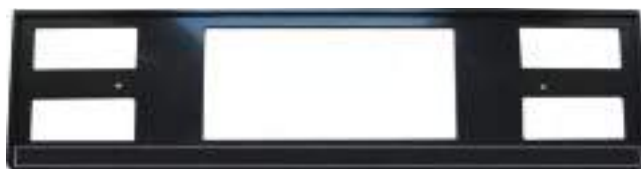

51697 0,80€



RASQUETA QUITA-HIELO



50526

4,80€

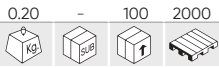

PARAGUAS PLEGABLE



50525

1,00€

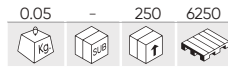

PONCHO IMPERMEABLE



51925

1,00€

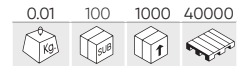

TIJERAS MINI DE 9 CM



52618

29,00€

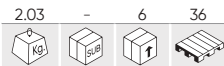

SET ORGANIZADOR DE MALETERO MULTIFUNCIONAL

- Set compuesto de 4 piezas:
- Cofre flexible 37L con tapa (300mm x 490mm).
 - Bidón circular con tapa Ø 180mm (230mm altura).
 - Colgador portaobjetos sin tapa (90mm altura x 260mm largo).
 - Bandeja rígida (175mm altura x 300mm largo).



53221

4,75€

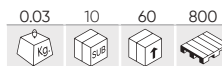

SET 3 GAMUZAS DE MICROFIBRA



53561

28,00€



CALZO DE PLÁSTICO PARA BLOQUEAR RUEDAS



53508

14,00€

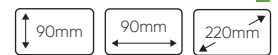

SET DE 2 CALZOS PARA VEHÍCULO



REF. DESCRIPCIÓN



14118 SOPORTE PARA CUÑA DE PLÁSTICO (REF. 53561) 1.25 4 80 26,00€

ACCESORIOS PARA VEHÍCULOS

51863

54,00€

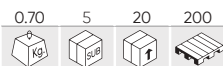

SENSOR DE APARCAMIENTO CON MEDIDOR DE APROXIMACIÓN VISUAL Y ACÚSTICO

- Voltaje nominal: DC 12 V.
- Potencia: 3,6 W.
- Temperatura de trabajo: -20° a 70°.
- 4 sensores de aproximación.
- Distancia de detección: 0,3-2,0 m.
- Ángulo de detección: H>60°, V>60°.
- Radiofrecuencia: 315 MHz / 433 MHz.
- Incluye indicador de 2 colores de marcado de aproximación.
- Sensores de color negro (no repintables).



51973

45,00€



SENSOR DE APARCAMIENTO CON MEDIDOR DE APROXIMACIÓN ACÚSTICO

- Voltaje nominal: DC 12 V.
- Potencia: 3,6 W.
- Temperatura de trabajo: -20° a 70°.
- 4 sensores de aproximación.
- Distancia de detección: 0,3-2,0 m.
- Ángulo de detección: H>60°, V>60°.
- Radiofrecuencia: 315 MHz / 433 MHz.
- Sin indicador visual.
- Incluye zumbador de Ø 4cm.
- Sensores de color negro (no repintables).



TUBOS FLEXIBLES INNERBRAID



REF.	DESCRIPCIÓN					€
51706	Ø 25mmL x 300mmL	0.35	-	25	1500	22,80€
51707	Ø 45mmL x 100mmL	0.27	-	25	1200	9,05€
51708	Ø 45mmL x 150mmL	0.38	-	25	-	14,20€
51709	Ø 45mmL x 200mmL	0.50	-	25	-	14,70€
51710	Ø 45mmL x 250mmL	0.65	-	25	600	17,80€
51711	Ø 45mmL x 300mmL	0.71	-	25	-	21,20€
51712	Ø 50mmL x 100mmL	0.30	-	25	-	8,65€
51713	Ø 50mmL x 150mmL	0.45	-	25	-	13,10€
51714	Ø 50mmL x 200mmL	0.56	-	25	-	15,80€
51715	Ø 50mmL x 250mmL	0.70	-	25	-	20,30€
51716	Ø 50mmL x 300mmL	0.83	-	25	450	23,60€

REF.	DESCRIPCIÓN					€
51717	Ø 55mmL x 100mmL	0.35	-	25	-	11,20€
51718	Ø 55mmL x 150mmL	0.50	-	25	-	14,80€
51719	Ø 55mmL x 200mmL	0.65	-	25	-	22,00€
51720	Ø 55mmL x 250mmL	0.85	-	25	350	23,50€
51721	Ø 55mmL x 300mmL	1.00	-	25	375	25,00€
51722	Ø 60mmL x 100mmL	0.36	-	25	750	13,10€
51723	Ø 60mmL x 150mmL	0.50	-	25	450	18,70€
51724	Ø 60mmL x 200mmL	0.66	-	25	400	24,40€
51725	Ø 60mmL x 250mmL	0.83	-	25	-	28,30€
51726	Ø 60mmL x 300mmL	0.96	-	25	250	31,40€
51727	Ø 60mmL x 400mmL	1.62	-	25	200	49,00€

DISPONIBLE EN CAJA INDIVIDUAL

ACCESORIOS PARA NEUMÁTICOS

368 CONTRAPESAS

369 REPARACIÓN DE PINCHAZOS

370 VÁLVULAS DE NEUMÁTICO

371 EXTRACCIÓN E INSTALACIÓN



ACCESORIOS PARA NEUMÁTICOS

51908

44,00€



DISPENSADOR DE CONTRAPESAS DE HIERRO 5G

1.000 pastillas de 5g.
Autoadhesiva con 4 mm de espesor.
Medidas del dispensador:
29,5 cm x 29,5 cm.



Con imán de retención de sobrantes.

53256

34,00€



DISPENSADOR DE CONTRAPESAS DE HIERRO 5G

1.000 pastillas de 5g.
Autoadhesiva con 4 mm de espesor.
Medidas del dispensador:
29,5 cm x 29,5 cm.



CONTRAPESAS AUTOADHESIVAS

REF.	g					€
50600	45g: 3x5g/3x10g	0.05	100	400	36000	0,60€
50601	45g: 3x5g/3x10g	0.05	100	400	48000	0,29€



50600
ZINC

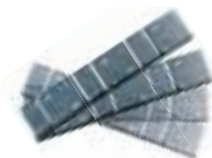

50601
HIERRO

CONTRAPESAS ADHESIVAS

REF.	g					€
52665	60g: 12x5g	0.06	100	400	20000	0,37€
52666	60g: 4x10g/4x5g	0.06	100	400	20000	0,36€



52665



52666

CONTRAPESAS DE GRAPA EN ZINC

ESPECIAL LLANTA UNIVERSAL

REF.	g					€
50760	5g	0.01	100	1600	80000	0,10€
50761	10g	0.01	100	1600	102400	0,19€
50762	15g	0.02	100	800	76800	0,29€
50763	20g	0.02	100	800	64000	0,38€
50764	25g	0.03	100	800	48000	0,49€
50765	30g	0.03	100	600	50400	0,58€
50766	35g	0.04	100	400	32000	0,68€
50767	40g	0.04	100	400	25600	0,78€
50768	45g	0.05	100	400	32000	0,88€
51055	50g	0.05	100	400	2000	0,98€



ESPECIAL LLANTA ALEACIÓN

REF.	g					€
50778	5g	0.01	100	1600	80000	0,10€
50779	10g	0.01	100	800	76800	0,19€
50780	15g	0.02	100	1200	60000	0,29€
50781	20g	0.02	100	800	80000	0,38€
50782	25g	0.03	100	600	48000	0,49€
50783	30g	0.03	100	600	30000	0,58€
50784	35g	0.04	100	400	32000	0,68€
50785	40g	0.04	100	400	32000	0,78€
50786	45g	0.05	100	400	32000	0,88€
51604	50g	0.05	100	400	25600	0,98€



x100

CONTRAPESAS UNIVERSALES PARA CAMIÓN

REF.	g					€
52667	50g	0.05	50	400	25600	0,76€
52668	100g	0.10	25	200	12800	1,49€
52669	150g	0.15	20	160	10240	2,22€
52670	200g	0.20	10	80	5120	2,95€
52671	250g	0.25	10	80	5120	3,70€
52672	300g	0.30	10	80	5120	4,45€



52667



52668



52669



52670



52671



52672

53864

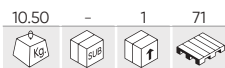

138,00€



ESTUCHE DE CONTRAPESAS SURTIDO

CONTRAPESAS DE ZINC CON GRAPA

CONTRAPESAS ADHESIVAS



LLANTA UNIVERSAL

LLANTA ALEACIÓN

60gr: 4x10gr 4x5gr - 70u. (ref. 52666)

- 5g - 20 uds (ref. 50760)
- 10g - 20 uds (ref. 50761)
- 15g - 20 uds (ref. 50762)
- 20g - 20 uds (ref. 50763)
- 25g - 20 uds (ref. 50764)
- 30g - 10 uds (ref. 50765)
- 35g - 10 uds (ref. 50766)
- 40g - 10 uds (ref. 50767)

- 5g - 20 uds (ref. 50778)
- 10g - 20 uds (ref. 50779)
- 15g - 20 uds (ref. 50780)
- 20g - 20 uds (ref. 50781)
- 25g - 20 uds (ref. 50782)
- 30g - 10 uds (ref. 50783)
- 35g - 10 uds (ref. 50784)
- 40g - 10 uds (ref. 50785)

51355

19,00€

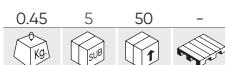

ALICATE ESPECIAL PARA CONTRAPESAS



- Extrae fácilmente y sustituye la contrapesa.
- Corta y dobla con facilidad.
- Hecho de acero templado.
- Incluye mango ergonómico.



53150

24,00€

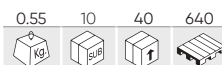

COMPRESOR DE AIRE PORTÁTIL - 12V/100W



54013

35,00€



KIT SELLADOR DE PINCHAZOS - LÍQUIDO Y COMPRESOR DE AIRE

REF.	DESCRIPCIÓN	Kg	SUB	Uds	Paq	€
A 15317	BOLSA PARA KIT PARA REF. 54013/53150	0.10	-	220	-	4,50€
B 15300	LÍQUIDO SELLADOR DE PINCHAZOS - 500ML	0.50	-	12	936	5,00€
C 11960	EXTRACTOR DE OBUSES	0.01	10	500	-	1,50€
D 53150	COMPRESOR DE AIRE PORTÁTIL - 12V/100W	0.55	10	40	640	24,00€

- Sella pinchazos de hasta 6mm.
- Material no corrosivo para metales ni gomas.
- No inflamable y anticongelante, de gran durabilidad.



51814

8,00€

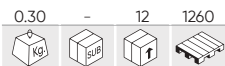

SPRAY REPARA PINCHAZOS 300ML

300ml



52653

3,00€

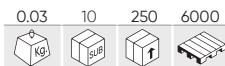

ÚTIL PARA OBUSES

- Para instalar y desinstalar obuses.



52652

2,80€

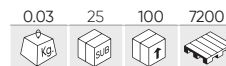

LLAVE MULTIFUNCIONAL PARA OBUSES



ACCESORIOS PARA NEUMÁTICOS

52662

36,50€

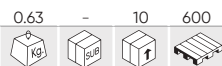

SET DE REPARACIÓN DE NEUMÁTICOS



- A 1 x Barrena de perforación
- B 1 x Barrena de inserción de mechas
- C 1 x Útil para inflar neumáticos
- D 4 x Botellas de aire comprimido 16gr
- E 1 x Cúter
- F 10 x Mechas
- G 1 x Llave multifuncional obuses

52663

30,00€



SET DE REPARACIÓN DE NEUMÁTICOS

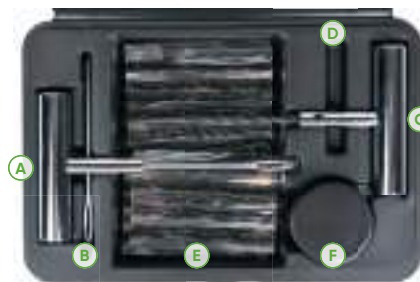

- A 1 x Barrena de inserción de mechas
- B 1 x Punta barrena de inserción de mechas
- C 1 x Barrena de perforación
- D 1 x Cúter
- E 20 x Mechas
- F 1 x Lubricante

REF. DESCRIPCIÓN

REF.	DESCRIPCIÓN						€
12973	SET DE 5 MECHAS DE RECAMBIO (REF. 52662/52663)	0.01	10	500	13500		1,00€
13805	BARRENA DE INSERCIÓN DE MECHAS (REF. 52663)	0.50	10	50	-		10,50€
13806	BARRENA DE PERFORACIÓN (REF. 52663)	0.35	5	50	-		10,50€

52673

18,00€



SET DE TAPONES Y OBUSES PARA NEUMÁTICOS



DESPIECE DISPONIBLE

REF.	DESCRIPCIÓN					€
11903	BOLSA DE 16 PCS DE TAPONES DE ALUMINIO PARA VÁLVULA NEUMÁTICA	0.01	1	100		5,00€
11904	BOLSA DE 50 PCS DE TAPONES DE PLÁSTICO VERDES PARA VÁLVULA NEUMÁTICO	0.10	10	500		2,00€
11905	BOLSA DE 50 PCS DE TAPONES DE PLÁSTICO NEGROS PARA VÁLVULA DE NEUMÁTICO	0.01	-	10		1,50€
11906	BOLSA DE 50 PCS PARA OBUSES ESTÁNDAR	0.04	-	100		8,50€
11907	BOLSA DE 50 PCS PARA OBUSES DE ALTA PRESIÓN	0.05	-	100		11,00€
11960	EXTRACTOR DE OBUSES	0.01	10	500		1,50€

TAMBIÉN DISPONIBLE

REF.	DESCRIPCIÓN					€
11900	SET DE 4 TAPONES DE ALUMINIO PARA VÁLVULA DE NEUMÁTICO	0.01	4	25	250	3,50€
11901	TAPÓN DE PLÁSTICO VERDE PARA VÁLVULA DE NEUMÁTICO	0.01	4	25	500	2,50€
11902	SET DE 4 TAPONES DE PLÁSTICO NEGROS PARA VÁLVULA NEUMÁTICO	0.01	4	25	300	3,50€

VÁLVULAS PARA LLANTAS

REF.	DESCRIPCIÓN						€
51741	TR413 45mm	0.01	100	1000	48000		0,50€
51742	TR414 51mm	0.01	100	1000	48000		0,50€
51743	TR418 64mm	0.02	100	1000	48000		0,55€



ÚTIL DE INSTALACIÓN DE VÁLVULAS PARA NEUMÁTICO

REF.	DESCRIPCIÓN						€
52649	METAL	0.32	10	50	2250		5,00€
52650	PLÁSTICO	0.15	10	100	2400		5,00€



52657

37,50€

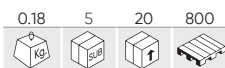

UÑA DE PLÁSTICO DE RECAMBIO PARA DESMONTADOR DE NEUMÁTICOS



52658

39,70€



UÑA DE PLÁSTICO DE RECAMBIO PARA DESMONTADOR DE NEUMÁTICOS



52659

39,70€



UÑA DE PLÁSTICO DE RECAMBIO PARA DESMONTADOR DE NEUMÁTICOS



54329

37,50€



UÑA DE PLÁSTICO DE RECAMBIO PARA DESMONTADOR DE NEUMÁTICOS



EUR - MADE IN SPAIN

52655

39,70€



PALANCA PLÁSTICA PARA DESCALZAR NEUMÁTICOS



52656

39,50€



PALANCA PLÁSTICA PARA DESCALZAR NEUMÁTICOS



PALANCA PARA LA EXTRACCIÓN DE NEUMÁTICOS

REF.	"						€
51362	12" (30,48cm)	0.15	5	60	500	3,00€	
51358	16" (40,64cm)	0.47	6	24	1008	7,50€	
51359	24" (60,96cm)	0.90	6	30	1440	9,00€	



CASQUILLO CENTRADOR

REF.	mm						€
52645	25x22x2,5mm	0.01	50	1000	38000	0,55€	
52646	25x12x2,0mm	0.00	50	1000	80000	0,50€	
53037	23x12x2,5mm	0.01	50	1000	35000	0,50€	
53038	21x12x2,5mm	0.01	50	1000	35000	0,50€	
53039	25x19x2,5mm	0.02	50	1000	35000	0,50€	
53040	25x9x2,5mm	0.01	50	1000	35000	0,50€	



52664

168,00€



PALANCA PARA CAMBIO DE RUEDAS INDUSTRIALES



53605

141,00€



950mm

DESMONTADOR DE NEUMÁTICOS MANUAL

- Capacidad de los neumáticos: Todas las llantas desde 8" hasta las llantas de camiones ligeros (7- 1/2" x 16").
- Neumáticos de flotación: Hasta 12,5L 16.
- Incluye: 1 Manija para interruptor de reborde 37 IN. Herramienta larga de montaje y desmontaje.



52660

126,00€

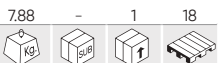

CARRO PORTA NEUMÁTICOS CAP. 200KG



52552

128,00€



CALZADOR DE NEUMÁTICOS PORTÁTIL



REF. DESCRIPCIÓN

REF.	DESCRIPCIÓN	Kg	Sub	Alt	Paq	€
13741	BOQUILLA DE RECAMBIO PARA REF.52552	0.35	-	32	-	21,00€

53542

980,00€

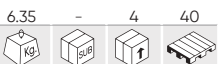

DESTALONADOR DE LLANTAS DE NEUMÁTICO



54198

59,00€



PORTADOR DE NEUMÁTICOS



54136

107,00€

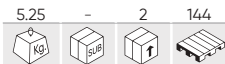

DESMONTADOR DE NEUMÁTICOS MANUAL



52842

11,00€

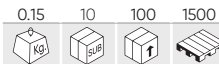

RODILLO PARA REPARACIÓN DE NEUMÁTICOS



53419

9,70€

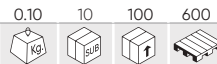

SET DE 3 PROTECTORES DE LLANTAS



SEGURIDAD Y EPIS

374 GUANTES / EPIS

377 MASCARILLAS / DISPENSADORES

379 DELIMITACIÓN

380 MEDIDOR DE OZONO





GUANTES DESECHABLES
100% DE NITRILO

GUANTES DESECHABLES DE NITRILO

3.5MIL
4.2g

REF.	UDS.				€
54294	S 100	0.40	10	500	8,00€
53984	M 100	0.45	10	500	8,00€
53985	L 100	0.50	10	500	8,00€
53986	XL 100	0.55	10	500	8,00€



3.5MIL
4.2g

REF.	UDS.				€
54155	M 100	0.46	10	570	8,00€
54156	L 100	0.50	10	570	8,00€
54157	XL 100	0.55	10	570	8,00€



5MIL
5.5g

REF.	UDS.				€
54151	M 100	0.60	10	500	9,00€
54152	L 100	0.60	10	500	9,00€
54153	XL 100	0.60	10	500	9,00€



GUANTES DESECHABLES DE NITRILO - TEXTURA DIAMANTE

7MIL
8.4g

REF.	UDS.				€
53551	M 100	0.90	10	300	16,00€
53552	L 100	1.00	10	300	16,00€
53553	XL 90	1.00	10	300	16,00€

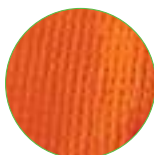

7MIL
8.4g

REF.	UDS.				€
54177	M 100	0.92	10	300	16,00€
54178	L 100	0.96	10	300	16,00€
54179	XL 90	0.97	10	300	16,00€

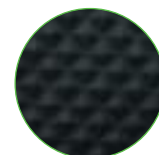

7MIL
8.4g

REF.	UDS.				€
54369	M 100	0.90	10	300	16,00€
54370	L 100	0.88	10	300	16,00€
54371	XL 100	1.05	10	300	16,00€

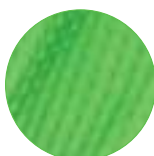

GUANTES CON PALMA REFORZADA DE POLIURETANO

REF.						€	
51640N	T.8		0.05	12	144	3456	1,54€
51642N	T.9		0.01	12	144	3456	1,54€
51636N	T.10		0.05	12	144	3456	1,54€
51638N	T.11		0.05	12	144	3456	1,54€



GUANTES CON PALMA REFORZADA DE NITRILO

REF.						€	
51633	T.8		0.04	12	144	3456	1,54€
51634	T.9		0.05	12	144	2592	1,54€
51632N	T.10		0.05	12	144	3456	1,54€
51398N	T.11		0.05	12	144	2592	1,54€



GUANTES DE TRABAJO DE INVIERNO

REF.						€	
54192	T.8		0.15	12	144	3456	8,90€
54193	T.9		0.10	12	144	3456	8,90€
54194	T.10		0.15	12	144	3456	8,90€
54195	T.11		0.10	12	144	3456	8,90€



GUANTES ANTI-CORTE DE PANTALLA TÁCTIL

REF.						€	
52570	T.8		0.03	12	144	3456	2,60€
52571	T.9		0.03	12	144	2592	2,60€
52572	T.10		0.03	12	144	2592	2,60€
52573	T.11		0.04	12	144	2592	2,60€



GUANTES DE PIEL

REF.						€	
52738	T.9		0.10	12	144	2304	5,00€
52739	T.10		0.12	12	144	2304	5,00€



GUANTES DE PIEL Y TELA

REF.					€
52310	0.20	12	120	1920	3,65€



SEGURIDAD Y EPIS

GUANTES DE ALGODÓN

REF.						€
51745	0.05	12	144	4320		0,70€



GUANTES DE HILO DE ALGODÓN CON LA PALMA REFORZADA DE PUNTITOS

REF.						€
51785	0.04	12	300	3600		1,00€

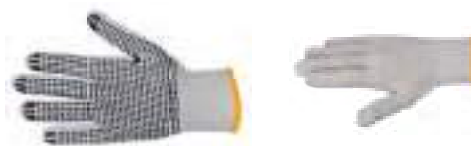

GUANTES DE TRABAJO

REF.						€
54188	T.8	0.15	12	60	2040	19,00€
54189	T.9	0.15	12	60	720	19,00€
54190	T.10	0.15	12	60	720	19,00€
54191	T.11	0.15	12	60	720	19,00€



PARA PANTALLA TÁCTIL



52430

10,90€

0.34	6	24	288

AURICULAR PASIVO PARA PROTECCIÓN AUDITIVA



CUMPLE CON: EN352 - 1:2003

53785

4,80€

0.05	14	112	896

GAFAS DE PROTECCIÓN ANTIVAHO



CUMPLE CON: EN166:2002-04

GAFAS DE PROTECCIÓN SPORT - ANTIVAHO

REF.					€
53596	0.01	12	144	2016	3,65€
53597	0.01	12	144	2016	3,70€
53598	0.01	12	144	2016	3,95€

CUMPLE CON: EN166:2002-04 / EN166:2003-01



EN EXPOSITOR DE 12 UNIDADES



53596



53597



53598

53794

28,00€

0.15	-	80	1280

TERMÓMETRO INFRARROJO PROFESIONAL

- Mide la temperatura corporal en 1 segundo y sin contacto.
- Apagado automático después de 1 minuto.

RANGO DE MEDICIÓN	32.0°C - 42.2°C (89.6°F - 108°F)
PRECISIÓN	±0.2°C (35°C - 42°C)



144mm	101mm	36mm
-------	-------	------



2 PILAS AAA

53862 6,00€

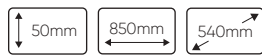
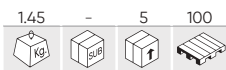

ALFOMBRA CON DEPÓSITO PARA LÍQUIDO DESINFECTANTE

- Medidas: 85x55x10cm
- Material: TPE
- Capacidad máxima recomendada: 3L
- Capacidad máxima: 8L



53863 3,00€

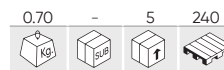

ALFOMBRA PARA SECADO

- Medidas: 76x48cm
- Material: Poliéster



53781 18,00€

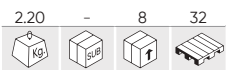

DISPENSADOR DE FUNDAS DE CALZADO



REF.	DESCRIPCIÓN	Kg	U	Pa	€
14781	100 FUNDAS DE CALZADO PARA REF. 53781	0.25	84	336	990€

53797 0,10€

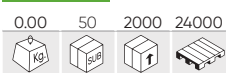

MASCARILLA PROTECCIÓN INDIVIDUAL HIGIÉNICA (DE UN SOLO USO)



En bolsas de 10 unidades.
Entregadas en cajas de 50 unidades.

USO NO MÉDICO

EFB EFICACIA A LA FILTRACIÓN BACTERIANA	>98%
RESISTENCIA A LA RESPIRACIÓN	35-50 Pa

Este dispositivo no es un producto sanitario en el sentido de la Directiva 93/42 o del Reglamento UE/2017/745, ni un equipo de protección individual en el sentido del Reglamento UE/2016/425. PARA USO PERSONAL, NO REUTILIZABLE.

53957 0,26€

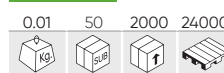

MASCARILLA NEGRA DE PROTECCIÓN INDIVIDUAL HIGIÉNICA (DE UN SOLO USO)



En bolsas de 10 unidades.
Entregadas en cajas de 50 unidades.

USO NO MÉDICO

EFB EFICACIA A LA FILTRACIÓN BACTERIANA	>90%
RESISTENCIA A LA RESPIRACIÓN	63-69 Pa

53946 0,83€



MASCARILLA DE PROTECCIÓN FFP2 - NEGRA



Homologada según reglamento UE 2016/425
Cumple con normativa EN149:2001+A1:2009

53826

16,00€

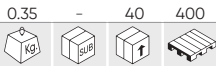

DISPENSADOR DE GEL AUTOMÁTICO - 400 ML

- Compatible con jabón líquido, alcohol, gel y desinfectante de manos.
- Sensor infrarrojo de movimiento con luz led.
- Dosificación: 1ml.
- Voltaje: 6V (4 pilas de 1,5V).
- Pilas no incluidas.



14793

12,00€



BOMBA DOSIFICADORA GARRAFA - 5L



53902

25,00€

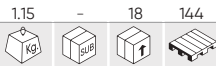

DISPENSADOR AUTOMÁTICO - 1200ML

- Dosificación: Ajustable de 0,7ml a 1,4ml.
- Compatibles con jabón líquido, alcohol, gel y desinfectante de manos.
- Voltaje: 6V 1.5A
- Medidas: 160x120x295mm.
- Material: ABS.



53827

32,00€



PIE PARA DISPENSADOR DE GEL AUTOMÁTICO

- Peso: 4.3kg
- Material: Acero
- Color: Negro
- Medidas de la bandeja: 417x67mm
- Medidas del soporte para el dispensador: 480x133mm
- Diámetro de la base: 395mm



REF. DESCRIPCIÓN

REF.	DESCRIPCIÓN	Kg	Material	Cant.	Unid.	€
15059	ADAPTADOR AC/DC 6V 1.5A	0.10	-	200	-	10,00€
15062	PILA R14 C1.5V	0.05	24	480	-	1,00€

EXTENSIBLE
1.25m - 1.58m

53832

1,81€

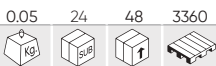

GEL HIDROALCOHÓLICO 60ML



EN EXPOSITOR
DE 24 UNIDADES

53791

4,80€

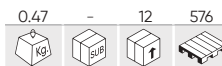

GEL HIDROALCOHÓLICO PARA MANOS - 500ML



52493

4,50€



PISTOLA PLÁSTICA PARA BOTE DE SPRAY



53940 13,20€

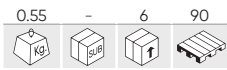

850mm

POSTE DE PLÁSTICO PARA CADENA - AMARILLO/NEGRO

- De PVC.
- Franjas amarillas y negras.
- Base rellenable de agua o arena.

CADENA NO INCLUIDA.



54322 19,00€

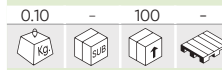

N

SET DE 2 CARTELES DE ADVERTENCIA ALTO VOLTAJE

165mm 500mm



53987 9,50€

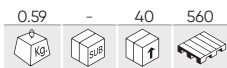

CINTA DE BALIZAMIENTO 200M - AMARILLA / NEGRA



53942 0,50€



ESLABÓN DE ENCAJE NEGRO



54326 7,30€

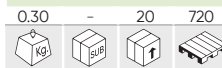

N

CADENA DE PLÁSTICO 7M - AMARILLA / NEGRA

7m



53808 16,50€

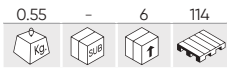

850mm

POSTE DE PLÁSTICO PARA CADENA - ROJO / BLANCO

- De PVC.
- Franjas blancas y rojas.
- Base rellenable de agua o arena.



53914 75,00€

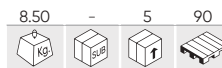

POSTE DE SEPARACIÓN CON CINTA RETRÁCTIL

- Material: Acero
- Diámetro del tubo: 63mm
- Diámetro de la base: 320mm
- Altura: 910mm
- Salida de cinta en 4 direcciones
- Largo de la cinta: 3m
- Ancho de cinta: 48mm



53811 8,90€

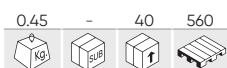

CINTA DE BALIZAMIENTO 200M - BLANCA / ROJA



53839 0,25€

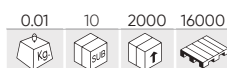

ESLABÓN DE ENCAJE ROJO



53809 8,00€



CADENA DE PLÁSTICO 5M - BLANCA / ROJA

- Longitud: 5m
- Eslabón: 6mm
- Color: rojo / blanco



53796

76,00€

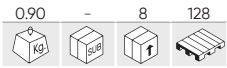

GENERADOR DE OZONO PORTÁTIL 600 MG/H (12V/220V)



600mg/h

Temporizador/Timer	30/30min	60min	HOLD
--------------------	----------	-------	------

53786

98,00€

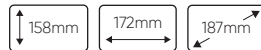
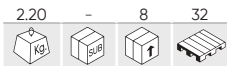

GENERADOR DE OZONO PORTÁTIL 5000 MG/H (220V)



Tiempo de operación recomendado según el tamaño de la habitación:

5.000mg/h

50m³	20 min
100m³	40 min
150m³	60 min
200m³	80 min
300m³	100 min

53806

250,00€

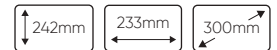

GENERADOR DE OZONO PORTÁTIL 20000 MG/H (220V)

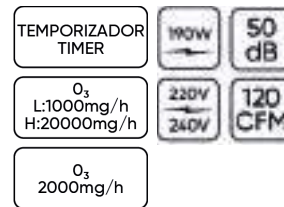

Tiempo de operación recomendado según el tamaño de la habitación:

10.000mg/h

20.000mg/h

50m³	8 min	500m³	30 min
100m³	16 min	600m³	40 min
150m³	24 min	700m³	50 min
200m³	32 min	800m³	60 min
300m³	48 min	900m³	70 min
500m³	65 min	1.000m³	80 min

REF.	DESCRIPCIÓN	0.02	1	€
14775	PLACA DE RECAMBIO PARA GENERADOR DE OZONO PORTÁTIL (REF.53786)			30,50€

REF.	DESCRIPCIÓN	0.03	50	€
14803	PLACA PARA GENERADOR DE OZONO PORTÁTIL 20000 MG/H (REF.53806)			43,00€

53838

38,00€

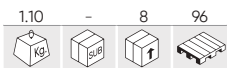

CAJA DE TRATAMIENTO DE OZONO



- Longitud de onda ultravioleta: 254 Nm
- Toma de potencia: Conector micro-USB
- La caja se monta y desmonta fácilmente, facilitando así su transporte.

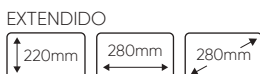

53802

120,00€

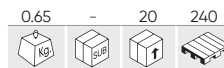

MEDIDOR DE OZONO

- Precisión: ±5% F.S.
- Rango de medición: 0-50ppm (0-98mg/m3)
- Alarma baja: 5ppm (9.8mg/m3)
- Alarma alta: 10ppm (19.6 mg/m3)
- Tiempo de respuesta: <30 segundos
- Temperatura de trabajo: -10°C - 55°C
- Protección IP65.



DOS NIVELES DE ALARMA CONFIGURABLES PARA DIFERENTES NIVELES DE CONCENTRACIÓN

TIEMPO DE TRABAJO: >8H
TIEMPO DE CARGA: 4H-6H



CONSUMIBLES

- 383** PASADORES Y CIRCLIPS
- 384** REMACHES
- 384** TORNILLOS TUERCAS ARANDELAS
- 388** ARANDELAS DE CARTER Y MOTOR
- 391** OTROS
- 391** JUNTAS Y TÓRICAS
- 392** CONECTORES DE MANGUERA
- 393** ELÉCTRICOS
- 396** CLIPS Y GRAPAS DE PLÁSTICO



CONSUMIBLES

52044

19,00€

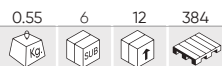

ESTUCHE DE CLIPS EN R 150 PCS



REF.	Image	PCS	€
10793		2,3x43	25 0,25€
10794		3,2x52	20 0,40€
10795		3,8x75	8 0,60€
10882		2x32	42 0,25€
10883		1,6x36	30 0,25€
10884		1,6x42	25 0,25€

52027

14,00€



ESTUCHE DE PASADORES DE ALETAS 365 PCS



REF.	Image	PCS	€
10796		1,2x25	50 0,07€
10797		1,6x32	50 0,09€
10798		2x40	50 0,12€
10799		2,5x40	50 0,13€
10800		3,2x40	50 0,15€
10801		3,2x50	50 0,17€
10802		4x50	40 0,19€
10803		5x63	10 0,05€
10804		6,3x63	15 0,22€

53348

14,00€

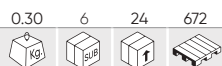

ESTUCHE DE CIRCLIPS TIPO E 150 PCS



Image	PCS
	15
M3 - 1/8"	15
M5 - 3/16"	20
M6 - 1/4"	25
M9 - 3/8"	25
M12 - 1/2"	20
M15 - 5/8"	10
M19 - 3/4"	10
M22 - 7/8"	10

53350

14,00€



ESTUCHE DE PASADORES ELÁSTICOS 120 PCS



1/16" x 3/16"	4	3/16" x 5/8"	5
1/16" x 5/16"	4	3/16" x 1"	5
1/16" x 3/4"	4	3/16" x 1-1/4"	5
5/64" x 1/4"	4	7/32" x 5/8"	4
5/64" x 1/2"	4	7/32" x 1-1/4"	4
5/64" x 1"	4	7/32" x 1-3/4"	4
3/32" x 5/8"	4	1/4" x 5/8"	4
3/32" x 1"	4	1/4" x 1-1/4"	4
3/32" x 1-1/4"	4	1/4" x 1-3/4"	4
1/8" x 5/8"	5	5/16" x 3/4"	4
1/8" x 1"	5	5/16" x 1-1/2"	4
1/8" x 1-1/4"	5	5/16" x 2"	4
5/32" x 5/8"	4	3/8" x 3/4"	2
5/32" x 1"	4	3/8" x 1-1/2"	2
5/32" x 1-1/2"	4	3/8" x 2"	2

53363

34,00€



ESTUCHE DE PASADORES CLEVIS Y CLIPS EN R 71 PCS

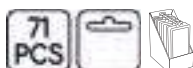

Image	PCS
	6
2.5x42	20
2.5x58	7
2x3	7

Image	PCS
	5
9.5x50	18
11x63	5
12.5x50	3

53364

16,00€



ESTUCHE DE CHAVETAS 60 PCS



Image	PCS
	4
3x3x20	4
5x5x30	5
5x5x25	5
5x5x20	5
6x6x40	5
6x6x30	5
6x6x20	5
8x8x40	5
8x8x30	5
10x10x40	5
10x10x30	5
12x12x40	2

53371

29,00€

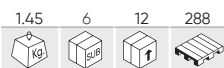

ESTUCHE DE PASADORES CON ANILLA 50 PCS



	PCS
5x36	16
6x45	18
8x45	6
11x45	10

53372

26,00€



ESTUCHE DE PASADORES DE ALETAS INOX 144 PCS

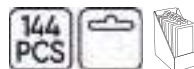

	PCS
M3x50	50
M4x60	30
M5x75	20
M6x50	20
M6x75	16
M8x60	8

53373

14,50€

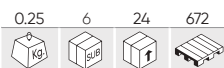

ESTUCHE DE ARANDELAS DENTADAS INTERIOR 260 PCS



	PCS
M3x10	30
M4x12	30
M5x14	40
M6x14	50
M8x18	50
M10x20	40
M12x25	20

53383

11,50€

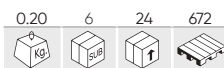

ESTUCHE DE ARANDELAS SEEGER EXTERIORES 300 PCS

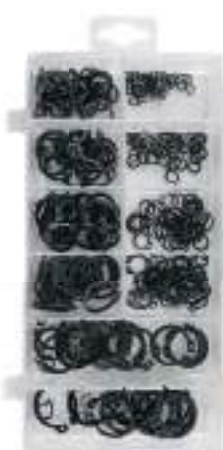

	PCS
M4	50
M6	40
M8	45
M10	30
M12	30
M14	25
M16	25
M18	25
M20	15
M22	15

53382

11,00€



ESTUCHE DE ARANDELAS SEEGER INTERIORES 300 PCS



	PCS
M4	50
M6	40
M8	45
M10	30
M12	30
M14	25
M16	25
M18	25
M20	15
M22	15

52711

27,50€



ESTUCHE DE REMACHES PLÁSTICOS 150 PCS



REF.		PCS	€
13674	6x19,3mm	25	0,50€
13675	6x17,8mm	25	0,50€
13676	6x25,5mm	25	0,50€
13677	6x24,5mm	25	0,50€
13678	6x24mm	50	0,50€

52703

22,00€



ESTUCHE DE REMACHES TUERCA 235 PCS



REF.		PCS	€
13235	M3	50	0,15€
13236	M4	50	0,15€
13237	M5	50	0,15€
13238	M6	40	0,20€
13239	M8	20	0,20€
13240	M10	15	0,40€
13241	M12	10	0,55€

53360

18,00€



ESTUCHE DE REMACHES TUERCA 150 PCS

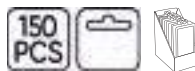

	PCS
3x9	40
4x11	35
5x13	25
6x15	25
8x18	15
10x21	10

53361

24,00€



ESTUCHE DE REMACHES TUERCA DE ALUMINIO 150 PCS



	PCS
3x9	40
4x11	35
5x13	25
6x15	25
8x18	15
10x21	10

52043

16,50€

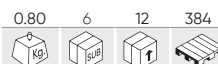

ESTUCHE DE REMACHES 300 PCS



REF.		PCS	€
10877	4,8x16,90mm	50	0,25€
10878	4,8x24,80mm	40	0,30€
10879	3,2x9,70mm	90	0,20€
10880	4,8x12,70mm	70	0,20€
10881	4,80x20mm	50	0,25€

53351

12,50€

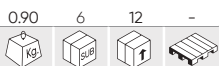

ESTUCHE DE TORNILLOS Y TUERCAS 240 PCS



	PCS		PCS
M4x12	10	M4	20
M4x20	10	M5	20
M5x16	10	M6	20
M5x25	10	M8	10
M6x20	10	M10	10
M6x30	10		
M8x25	5	PCS	
M8x40	5	M4	20
M10x16	5	M5	20
M10x40	5	M6	20
		M8	10
		M10	10

53354

14,00€

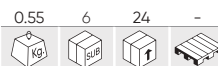

ESTUCHE DE TORNILLOS AUTORROSCANTES 200 PCS



	PCS
#8x12.5	30
#8x16	30
#8x19	30
#8x25	30
#10x12.5	20
#10x16	20
#10x19	20
#10x25	20

53362 14,00€

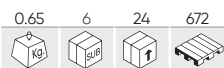

ESTUCHE DE TORNILLOS ALLEN 106 PCS



	PCS
4x12	25
5x12	25
5x25	20
10x40	3
6x25	10
8x40	5
10x25	3
6x12	10
8x25	5



53365 14,00€

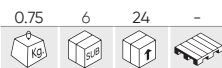

ESTUCHE DE TUERCAS MARIPOSA 150 PCS



	PCS
M4	40
M5	40
M6	25
M8	25
M10	20



53366 14,00€



ESTUCHE DE TORNILLOS Y TUERCAS TIPO U 170 PCS



	PCS
M3.5x8	40
M4.2x16	20
M5x12	15
M6.35x19	10

	PCS
M3.5	20
M3.5 Con muesca/with notch	20
M4	20
M5	15
M6.35	10



53369 14,00€



ESTUCHE DE TORNILLOS 550 PCS



	PCS
2.8x13mm	65
2.8x16mm	55
3.5x10mm	60
3.5x13mm	65
3.5x16mm	60
3.5x19mm	45
4.2x13mm	50
4.2x16mm	40
4.2x25mm	30
4.2x31mm	20
4.8x19mm	25
4.8x25mm	20
4.8x32mm	15



52029 14,00€



ESTUCHE DE TUERCAS AUTOBLOCANTES 228 PCS

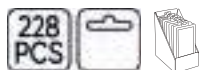

	PCS
M3	50
M4	50
M5	40
M6	30
M8	20
M10	15
M12	10
M14	8
M16	5



52028 15,20€



ESTUCHE DE TUERCAS 243 PCS



REF.		PCS	€
10805	M3	50	0,10€
10779	M4	50	0,05€
10780	M5	50	0,05€
10781	M6	30	0,05€
10784	M8	20	0,05€
10785	M10	20	0,10€
10786	M12	10	0,15€
10812	M14	8	0,30€
10813	M16	5	0,30€



CONSUMIBLES

52032

28,00€

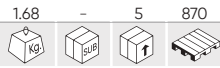

ESTUCHE ARANDELAS GROWNER NEGRAS
1.735 PCS



	PCS
3mm	600
4mm	400
5mm	220
6mm	220
8mm	110
10mm	65
12mm	50
14mm	40
16mm	30



53377

20,00€

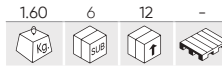

ESTUCHE DE ARANDELAS DE HIERRO
SOBREMEDIDA 240 PCS



	PCS
20x6x1.5	20
20x8x1.5	20
20x10x1.5	20
25x6x1.5	20
25x8x1.5	20
25x10x1.5	20
32x2x1.5	20
32x4x1.5	20
32x6x1.5	20
32x8x1.5	20
32x10x1.5	20
32x10x1.5	20



52158

38,50€

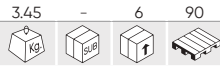

ESTUCHE DE ARANDELAS DE HIERRO GALVANIZADO 475 PCS

475
PCS

	PCS		PCS
5x20x1.5	50	6x30x2	25
6x20x1.5	50	7x30x2	25
7x20x1.5	50	8x30x2	25
8x20x1.5	50	4x11x0.98	50
8x25x1.75	50	12x40x3	25
10x30x2.5	25	4x20x1.5	50



51804

58,00€

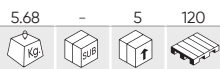

ESTUCHE SURTIDO DE TORNILLOS, TUERCAS Y ARANDELAS 828 PCS

828
PCS

REF.	DESCRIPCIÓN	PCS	€
10772	TORNILLO ZINCADO DIN 933 8.8 4X25	25	0,05€
10773	TORNILLO ZINC. DIN933 8.8 M5X25U	25	0,10€
10774	TORNILLO DIN 933 8.8 M6X25U	25	0,10€
10775	TORNILLO ZINCADO DIN 933 8.8 M7X50	15	0,15€
10776	TORNILLO ZINCADO DIN 933 8.8 M8X50	15	0,20€
10777	TORNILLO ZINCADO DIN 933 8.8 M10X50	12	0,20€
10778	TORNILLO ZINCADO DIN 933 8.8 M12X60	20	0,35€
10779	TUERCA ZINCADA DIN 934 M4	50	0,05€
10780	TUERCA ZINCADA DIN934 M5	50	0,05€
10781	TUERCA ZINCADA DIN 934 M6	50	0,05€
10782	TUERCA ZINCADA DIN 934 M7	50	0,05€
10783	ARANDELA ZINCADA DIN 125 M12	50	0,05€
10784	TUERCA ZINCADA DIN 934 M8	50	0,05€
10785	TUERCA ZINCADA DIN 934 M10	50	0,10€
10786	TUERCA ZINCADA DIN 934 M12	40	0,15€
10787	ARANDELA ZINCADA DIN 125 M4	50	0,05€
10788	ARANDELA ZINC DIN125 M5	50	0,05€
10789	ARANDELA ZINCADA DIN 125 M6	50	0,05€
10790	ARANDELA ZINCADA DIN 125 M7	50	0,05€
10791	ARANDELA ZINCADA DIN 125 M8	50	0,05€
10792	ARANDELA ZINCADA DIN 125 M10	50	0,05€

REF.	DESCRIPCIÓN	PCS	€
50959	CAJA 20+1 COMPARTIMENTOS	1	14,00€



53464

153,00€



551 PCS

ESTUCHE DE ARANDELAS DE COBRE PARA INYECTORES 551 PCS

DESPIECE DISPONIBLE

REF.	DESCRIPCIÓN	PCS	€
13945	Ø15.0x8.0x1.5 - UNIVERSAL	30	7,40€
13946	Ø15.0x7.0x1.5 - MERCEDES	12	6,70€
13947	Ø13.0x7.5x2.5 - RENAULT	30	5,85€
13948	Ø15.0x7.5x1.5 - IVECO, FORD, BMW, MAN	30	5,00€
13949	Ø15.0x7.5x2.0 - IVECO, FORD, BMW, MAN	30	6,50€
13950	Ø15.45x8.0x2.0 - UNIVERSAL	30	7,80€
13951	Ø13.5x10x2.0 - MAZDA (REF.. 53464)	12	5,15€
13952	Ø15.5x7.5x2.5 - FORD	30	10,90€
13953	Ø15.5x7.5x1.5 - LAND ROVER	12	8,00€
13954	Ø15.0x7.5x3.0 - RENAULT	30	12,70€
13955	Ø13.0x7.0x1.5 - DEUTZ	12	4,95€
13956	Ø13.5x7.5x1.5 - FORD	30	4,30€
13957	Ø15.0x7.5x1.5 - FIAT	12	9,70€
13958	Ø15.5x7.5x1 - MAN ROVER	12	5,45€
13959	Ø16.5x7.5x2 - MERCEDES	30	10,10€
13960	Ø13.7x7.3x3 - KIA	12	9,65€
13961	Ø13.7x7.3x2 - KIA	12	9,25€
13962	Ø10x6.0x1.0	50	1,76€
13963	Ø15.8x7.5x3.0	30	12,40€
13964	BOLSA DE 30 CONECTORES DE MANGUERA EN "T"	20	15,00€
13965	Ø8x5.8x1	30	1,50€
13966	BOLSA DE 30 CONECTORES DE MANGUERA EN "L"	30	12,90€
13967	BOLSA DE 30 RESORTES DE RETENCIÓN	25	4,65€



52031

44,00€



ESTUCHE DE ARANDELAS DE ALUMINIO 900 PCS



Ø	PCS
3x7x1.5	50
4x8x1.5	50
5x6x1.5	50
16x22x1.5	50
14x22x1.5	50
14x20x1.5	50
6x10x1.5	50
6x11x1.5	50
7x11x1.5	50
7x12x1.5	50
8x12x1.5	50
8x14x1.5	50
9x12x1.5	50
10x14x1.5	50
11x16x1.5	50
11x17x1.5	50
12x16x1.5	50
12x18x1.5	50



53353

18,00€



ESTUCHE DE ARANDELAS DE COBRE 110 PCS



Ø	PCS
M6	30
M8	25
M10	20
M12	15
M14	10
M16	10



52163

95,00€

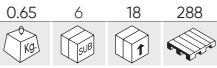

ESTUCHE DE ARANDELAS DE COBRE PARA TAPÓN DE CÁRTER 525 PCS



DESPIECE DISPONIBLE

REF.	mm	PCS	€
51538	Ø 10mm	100	0,15€
51539	Ø 12mm	100	0,15€
51540	Ø 14mm	100	0,15€
51541	Ø 16mm	100	0,25€
51542	Ø 18mm	100	0,20€
51543	Ø 20mm	25	0,25€

TAMBIÉN TE PUEDE INTERESAR...

REF.	mm	PCS	€
51544	Ø 22mm	100	0,25€
51545	Ø 26mm	100	0,30€



52030

98,00€

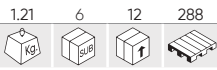

ESTUCHE DE ARANDELAS 18 COBRE 900 PCS

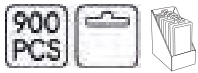

DESPIECE DISPONIBLE

REF.	mm	PCS	€	REF.	mm	PCS	€
10823	3x7x1,5mm	50	0,20€	10832	7x12x1,5mm	50	0,20€
10824	4x8x1,5mm	50	0,20€	10833	8x12x1,5mm	50	0,20€
10825	5x6x1,5mm	50	0,20€	10834	8x14x1,5mm	50	0,25€
10826	16x22x1,5mm	50	0,40€	10835	9x12x1,5mm	50	0,25€
10827	14x22x1,5mm	50	0,60€	10836	10x14x1,5mm	50	0,30€
10828	14x20x1,5mm	50	0,45€	10837	11x16x1,5mm	50	0,30€
10829	6x10x1,5mm	50	0,20€	10838	11x17x1,5mm	50	0,30€
10830	6x11x1,5mm	50	0,20€	10839	12x16x1,5mm	50	0,40€
10831	7x11x1,5mm	50	0,20€	10840	12x18x1,5mm	50	0,35€



ESTUCHE DE ARANDELAS DE COBRE PARA INYECTORES

53229

38,70€

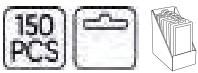
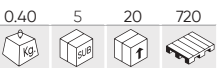

PCS	PCS
13,8 x 7,3 x 1,4mm 10	15,0 x 7,5 x 3,0mm 10
14,6 x 7,5 x 1,3mm 10	15,5 x 7,5 x 2,0mm 10
14,6 x 7,5 x 3,0mm 10	16,0 x 7,5 x 1,5mm 10
15,0 x 7,0 x 2,0mm 10	16,0 x 7,5 x 1,7mm 10
15,0 x 7,5 x 1,0mm 10	16,0 x 7,5 x 2,0mm 10
15,0 x 7,5 x 1,5mm 10	16,4 x 7,5 x 2,0mm 10
15,0 x 7,5 x 2,0mm 10	20,0 x 9,4 x 0,9mm 10
15,0 x 7,5 x 2,5mm 10	



53340

86,00€

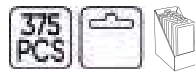

PCS	PCS
13,8 x 7,3 x 1,4mm 25	15,0 x 7,5 x 3,0mm 25
14,6 x 7,5 x 1,3mm 25	15,5 x 7,5 x 2,0mm 25
14,6 x 7,5 x 3,0mm 25	16,0 x 7,5 x 1,5mm 25
15,0 x 7,0 x 2,0mm 25	16,0 x 7,5 x 1,7mm 25
15,0 x 7,5 x 1,0mm 25	16,0 x 7,5 x 2,0mm 25
15,0 x 7,5 x 1,5mm 25	16,4 x 7,5 x 2,0mm 25
15,0 x 7,5 x 2,0mm 25	20,0 x 9,4 x 0,9mm 25
15,0 x 7,5 x 2,5mm 25	



53229 - 53340 DESPIECE DISPONIBLE

REF.	mm	PCS	€	REF.	mm	PCS	€	REF.	mm	PCS	€
13819	13,8 x 7,3 x 1,4mm	50	6,50€	13823	15,0 x 7,5 x 1,0mm	50	6,00€	13827	15,0 x 7,5 x 3,0mm	50	15,00€
13820	14,6 x 7,5 x 1,3mm	50	7,00€	13824	15,0 x 7,5 x 1,5mm	50	8,00€	13828	15,5 x 7,5 x 2,0mm	50	11,50€
13821	14,6 x 7,5 x 3,0mm	50	14,00€	13825	15,0 x 7,5 x 2,0mm	50	11,50€	13829	16,0 x 7,5 x 1,5mm	50	10,50€
13822	15,0 x 7,0 x 2,0mm	50	11,00€	13826	15,0 x 7,5 x 2,5mm	50	13,00€	13830	16,0 x 7,5 x 1,7mm	50	10,50€
								13831	16,0 x 7,5 x 2,0mm	50	12,60€
								13832	16,4 x 7,5 x 2,0mm	50	13,00€
								13833	20,0 x 9,4 x 0,9mm	50	9,00€

54390

199,00€



N

ESTUCHE DE CONECTORES Y TUBOS PARA COMBUSTIBLE 95 PCS

DESPIECE DISPONIBLE

REF.	mm	PCS	€	REF.	mm	PCS	€
16462	6,3x6mm	3	36,50€	16538	7,5x200mm	3	19,50€
16463	7,89x8mm	3	36,50€	16539	12x200mm	1	18,00€
16464	9,49x8 mm	3	36,50€	16540		1	13,00€
16465	9,89x8 mm	3	39,50€	16541	6x340mm	2	13,00€
16466	11,80x10mm	3	50,00€	16542	8x340mm	6	23,50€
16467	6,3x6 mm	3	36,50€	16543	9,5x340mm	2	13,00€
16468	7,89x8 mm	3	36,50€				
16469	9,49x8 mm	3	36,50€				
16470	9,89x8 mm	3	39,50€				
16471	11,8x10mm	3	50,00€				
16472	6,3x6 mm	5	17,50€				
16473	7,89x8mm	5	17,50€				
16474	9,49x8 mm	5	17,50€				
16475	9,89x8mm	5	17,50€				
16476	11,8x10 mm	5	24,00€				
16477	6x7,5mm	3	24,50€				
16478	8x7,5mm	6	24,50€				
16479	15 - 18mm	12	7,50€				
16480	17-20mm	4	7,50€				

95 PCS



ARANDELAS DE TAPÓN DE CÁRTER

REF.	DESCRIPCIÓN					€
52719	ARANDELA DE TAPÓN DE CÁRTER METALOPLÁSTICA 10MM DIAM.	0.00	100	5000	150000	0,19€
51843	ARANDELA DE TAPÓN DE CÁRTER METALOPLÁSTICA 12MM DIAM.	0.01	100	5000	200000	0,19€
51554	ARANDELA DE TAPÓN DE CÁRTER GOMA (FORD) 13MM DIAM.	0.00	100	5000	180000	0,28€
51546	ARANDELA DE TAPÓN DE CÁRTER METALOPLÁSTICA 14MM DIAM.	0.00	100	5000	150000	0,19€
51799	ARANDELA DE TAPÓN DE CÁRTER METALOPLÁSTICA 16MM DIAM.	0.01	100	120000	120000	0,20€



53599

30,30€

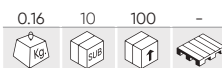

ESTUCHE DE OBUSES PARA AIRE ACONDICIONADO 134 PCS

134 PCS

DESPIECE DISPONIBLE

REF.	mm	PCS	€	REF.	mm	PCS	€
14594	5x19mm R12	50	2,00€	14599	7x20mm R134A	10	4,50€
14595	5x19mm	30	1,50€	14600	6x22mm	5	9,50€
14596	5x19mm R12	30	2,00€	14601	8x22mm	1	11,00€
14597	6x19mm	3	7,60€	14602	9x22mm	4	11,00€
14598	6x26mm	1	17,80€				



CONSUMIBLES

53358

11,50€

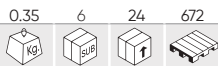

ESTUCHE DE MUELLES 200 PCS

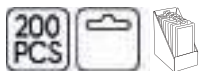

REF.	PCS	REF.	PCS
5/16x1-3/4	12	13/64x13/16	10
		7/32x1	10
		1/4x7/8	10
9/32x1/2	10	5/16x1-1/8	8
1/4x13/32	10	5/16x1-1/4	10
7/32x11/16	10	3/16x1-3/4	8
7/32x1-1/2	10	9/32x1-1/2	10
3/8x5/8	6	11/32x1-7/16	10
3/8x3/4	12	11/32x1-27/32	12
23/64x1-3/8	8	9/32x2	12
9/32x3/4	10	5/32x3-1/8	12



53352

12,00€



ESTUCHE DE TORNILLOS DE GANCHO 151 PCS



REF.	PCS
2.4x41	50
4x64	12
4.2x85	5

REF.	PCS
2.4x25	60
4x45	12
4x50	12



52033

43,00€

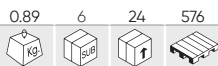

ESTUCHE DE ENGRASADOR 135 PCS



REF.	90°	PCS	€
10874	6x1	20	0,30€
10875	8x1	15	0,40€
10876	10x1	10	0,45€

REF.	ÁNGULO RECTO	PCS	€
10868	6x1	20	0,30€
10869	8x1	15	0,30€
10870	10x1	10	0,45€

REF.	45°	PCS	€
10871	6x1	20	0,30€
10872	8x1	15	0,40€
10873	10x1	10	0,45€



53359

16,00€

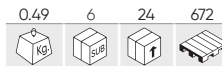

SURTIDO DE ENGRASADORES 110 PCS



REF.	90°	PCS
6x1	60	
8x1.25	10	
10x1.5	10	

REF.	ÁNGULO RECTO	PCS
6x1	5	
8x1.25	5	
10x1.5	5	

REF.	45°	PCS
6x1	5	
8x1.25	5	
10x1.5	5	



53378

13,00€



SURTIDO DE ABRAZADERAS DE TUBO 20 PCS



REF.	PCS
1"	4
2-1/2"	2
1-1/4"	2
3"	2
1-3/4"	2
3-1/2"	2
2"	4
4"	2



53381

14,50€

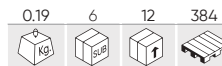

SURTIDO DE ARANDELAS DE FIBRA 600 PCS

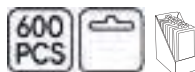

REF.	PCS
10x5.5x1	160
16x10x1	80
19x12x1	40
22x16x1	30
22.5x14x1	20
32x22x1	20
12x6.5x1	100
16x8x1	60
20x12.5x1	40
27x20x1	20
25.4x17.5x1	15
32x24x1	15



50651

18,00€

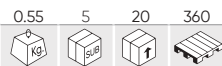

ESTUCHE DE JUNTAS TÓRICAS MÉTRICAS 386 PCS



	TAPA DEL ESTUCHE						BASE DEL ESTUCHE					
POSICIÓN DEL ESTUCHE	006	007	008	009	010	011	211	212	213	214	215	216
ANCHO DE GOMA (MM)	2	2	2	2	2	2	3	3	3	3	3	3
Ø INTERIOR (MM)	A 3	4	5	6	7	8	D 20	22	24	25	27	28
CANTIDAD	16	16	16	16	16	16	12	12	12	12	12	12
POSICIÓN DEL ESTUCHE	113	112	111	110	012	221	220	219	218	217		
ANCHO DE GOMA (MM)	B 2.5	2.5	2.5	2.5	2	E 3	3	3	3	3		
Ø INTERIOR (MM)	14	12	11	10	10	36	35	33	32	30		
CANTIDAD	13	13	13	13	17	12	12	12	12	12		
POSICIÓN DEL ESTUCHE	114	115	116	210	222	325	326	327				
ANCHO DE GOMA (MM)	C 2.5	2.5	2.5	3	F 3	4	4	4				
Ø INTERIOR (MM)	16	17	19	19	38	38	41	44				
CANTIDAD	13	13	13	10	12	10	9	9				



50652

16,50€

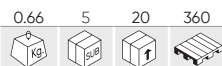

ESTUCHE DE JUNTAS TÓRICAS PULGADAS 382 PCS

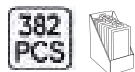

	TAPA DEL ESTUCHE						BASE DEL ESTUCHE					
POSICIÓN DEL ESTUCHE	006	007	008	009	010	011	211	212	213	214	215	216
ANCHO DE GOMA (MM)	1/16	1/16	1/16	1/16	1/16	1/16	D 1/8	1/8	1/8	1/8	1/8	1/8
Ø INTERIOR (MM)	A 1/8	5/32	3/16	7/32	1/4	5/16	13/16	7/8	15/16	1	11/16	11/18
CANTIDAD	20	20	20	20	20	20	10	10	10	10	10	10
POSICIÓN DEL ESTUCHE	113	112	111	110	012	221	220	219	218	217		
ANCHO DE GOMA (MM)	B 3/32	3/32	3/32	3/32	1/16	E 1/8	1/8	1/8	1/8	1/8		
Ø INTERIOR (MM)	9/16	1/2	7/16	3/8	3/8	17/16	13/8	15/16	11/4	13/16		
CANTIDAD	13	13	13	13	13	10	10	10	10	10		
POSICIÓN DEL ESTUCHE	114	115	116	210	222	325	326	327				
ANCHO DE GOMA (MM)	C 3/32	3/32	3/32	1/8	F 1/8	3/16	3/16	3/16				
Ø INTERIOR (MM)	5/8	11/16	3/4	3/4	11/2	11/2	15/8	13/4				
CANTIDAD	13	13	13	10	10	7	7	7				
CANTIDAD												



50807

38,00€

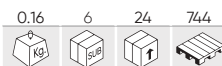

ESTUCHE DE JUNTAS TÓRICAS PARA AACC 270 PCS



Ø	PCS	Ø	PCS	Ø	PCS
5.29x1.78	20	8.80x1.90	20	13.95x2.62	10
6.07x1.78	20	10.82x1.78	15	14.0x2.0	10
6.8x1.9	20	10.77x2.62	15	15.0x2.0	10
7.65x1.78	20	11.0x2.0	15	17.0x2.0	10
7.80x1.90	20	12.0x2.0	15	17.17x1.78	10
8.0x2.0	20	13.9x1.80	10	17.04x3.53	10

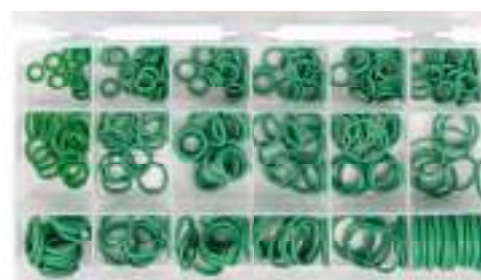

CONSUMIBLES

53910

19,00€

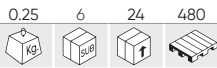

ESTUCHE DE CONECTORES DE MANGUERA
113 PCS

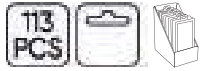

RECTO

4.8x4.8	10
6.3x6.3	8
7.9x7.9	6
9.5x9.5	6
3.17x3.17	30

EN T

3.9x3.9x3.9	8
4.8x4.8x4.8	8
6.3x6.3x6.3	6
9.5x9.5x9.5	3
3.17x3.17x3.17	12

REDUCTOR

9.5x6.3	6
6.3x4.8	10



53434

18,00€

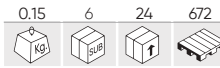

ESTUCHE DE CONECTORES DE MANGUERA
65 PCS



PCS

4x28.7	10
3.9x30.8	5
10.4x44	10
5.6x47.1	5
7.9x38	10
4.7x38.9	5
5.2x33.9	10
7x30	10



53992

18,00€

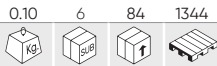

SET DE MANGUITOS DE SOLDADURA
TERMORETRACTILES 100 PCS

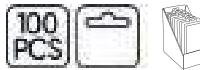

Ø1.7mm / 0.25-0.34mm ² / 26-24 AWG	25
Ø2.7mm / 0.5-1.0mm ² / 22-18 AWG	35
Ø4.7mm / 1.5-2.5mm ² / 16-14 AWG	30
Ø6.0mm / 4.0-6.0mm ² / 12-10 AWG	10

53349

14,00€

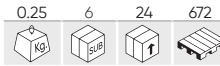

ESTUCHE DE PASACABLES DE GOMA 125 PCS



PASACABLES ABIERTOS:	PCS	PASACABLES CERRADOS:	PCS
M19,5x23	2	M25	2
M16x24	3	M22	3
M13x15	3	M19	4
M11,5x19	4	M15	5
M10x20	3	M12	10
M10x12	5	M9	20
M9,8x11,5	6	M7	20
M8x14	3		
M7,5x13	7		
M6x7,5	10		
M3,5x6	15		



53374

10,00€

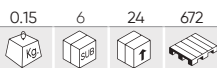

ESTUCHE DE TUBOS TERMORETRACTILES
NEGROS 127 PCS

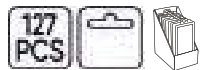

Tubo	PCS
M2x40	30
M2.5x40	25
M3.5x40	20
M5x40	20
M7x80	16
M10x80	8
M13x85	8



53376

10,50€



ESTUCHE DE TUBOS TERMORETRACTILES
ROJOS 127 PCS



Tubo	PCS
M2x40	30
M2.5x40	25
M3.5x40	20
M5x40	20
M7x80	16
M10x80	8
M13x85	8



REF. DESCRIPCIÓN

51920 SOPLETE DE GAS

0.14 10 100 400 € 18,00€

53370 26,00€

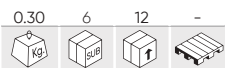

ESTUCHE DE PASACABLES DE GOMA 180 PCS



	PCS
M2	25
M3	25
M4	30
M5	30
M6	30
M8	20
M10	20

53355 11,50€

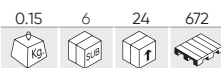

ESTUCHE DE MINI FUSIBLES 120 PCS



	PCS
5A	20
10A	20
15A	20
20A	20
25A	20
30A	20

53356 11,50€



ESTUCHE DE FUSIBLES 120 PCS



REF.		PCS	€
10915	5A	20	0,25€
10917	10A	20	0,30€

REF.		PCS	€
10918	15A	20	0,30€

REF.		PCS	€
10919	20A	20	0,30€
10920	25A	20	0,25€
10921	30A	20	0,30€

53367 9,50€



ESTUCHE DE FUSIBLES 48 PCS



	PCS
5A	8
10A	8
15A	8

	PCS
20A	8
25A	8
30A	8

53368 9,00€



ESTUCHE DE MINI FUSIBLES 50 PCS



	PCS
5A	8
10A	8
15A	8
20A	8
25A	8
30A	10

53380 11,50€



ESTUCHE DE MINI FUSIBLES 120 PCS



	PCS
5A	20
10A	20
15A	20
20A	20
25A	20
30A	20

52054

17,00€

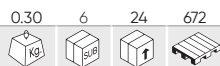

ESTUCHE DE FUSIBLES 252 PCS

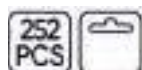

REF.	Icon	PCS	€
10905	3A	20	0,25€
10906	4A	20	0,25€
10907	5A	20	0,25€

REF.	Icon	PCS	€
10908	7,5A	20	0,30€
10909	10A	20	0,30€
10910	15A	20	0,30€

REF.	Icon	PCS	€
10911	20A	20	0,30€
10912	25A	20	0,25€
10913	30A	20	0,30€

REF.	Icon	PCS	€
10914	4A	8	0,25€
10915	5A	8	0,25€
12954	3A	8	0,25€

REF.	Icon	PCS	€
10916	7,5A	8	0,30€
10917	10A	8	0,30€
10918	15A	8	0,30€

REF.	Icon	PCS	€
10919	20A	8	0,30€
10920	25A	8	0,25€
10921	30A	8	0,30€



52053

45,00€

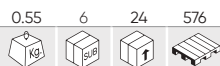

ESTUCHE DE TERMINALES 635 PCS



REF.	Icon	PCS	€
10885	RV1.25-4S	50	0,20€
10886	RV2-4S	50	0,20€
10887	RV2-6S	30	0,25€
10888	RV5.5-6S	20	0,30€
10889	RV5.5-5S	20	0,30€
10893	RV2-5S	40	0,25€

REF.	Icon	PCS	€
10894	SV1-4S	50	0,20€
10895	SV2-4S	40	0,20€

REF.	Icon	PCS	€
10896	FDD1.25-250	45	0,30€
10898	FDD2-250	40	0,30€
10900	FDD5.5-250	25	0,30€

REF.	Icon	PCS	€
10890	BV5.5	15	0,35€
10891	BV2	25	0,25€
10892	BV1.25	30	0,30€

REF.	Icon	PCS	€
10897	MDD1.25-250	50	0,30€
10899	MDD2-250	50	0,30€
10901	MDD5.5-250	30	0,25€

REF.	Icon	PCS	€
10902	FDN1.25-250	25	0,30€



ALICATES PARA TERMINALES

PÁGINA 61



53357

7,00€



SET DE 2 PINZAS DE COCODRILO



53385

19,30€



ALICATE PARA EXTRACCIÓN DE GRAPAS DE CARROCERÍA





16294

14,00€



POSTER CLIPS A TAMAÑO REAL

ESPECIFICACIONES TÉCNICAS:

Tamaño del póster: 1000x640mm
 Material: Papel de 250 g plastificado
 Tiene agujeros para poder colgarlo.



TAMAÑO REAL DE LOS CLIPS
 CLIPS REAL SIZE

52851

9,65€



SET DE 2 PALANCAS PARA EXTRACCIÓN DE GRAPAS



53110

27,30€



SET DE 6 PALANCAS



CONSUMIBLES



UNIDADES EN EL ESTUCHE



UNIDADES POR BOLSA DE RECAMBIO



PRESENTACIÓN EN EXPOSITOR

52896

26,00€



ESTUCHE DE CLIPS PLÁSTICOS MAZDA 190 PCS

REF.	DESCRIPCIÓN	UNIDADES	UNIDADES POR BOLSA	€
13104	OE:2042301	8	8	1,90€
13105	OE:999100402	15	15	2,50€
13106	OE:B0016830200	8	8	2,00€
13107	OE:N30413356A	8	8	2,15€
13108	OE:992640543A	20	20	1,90€
13109	OE:99249051B	30	30	2,90€
13110	OE:6508197AA	15	15	1,85€
13111	OE:B1016825200	10	10	1,20€
13112	OE:B09251833	6	6	1,65€
13113	OE:992640543A	20	20	2,20€
13114	OE:B45556741	20	20	2,20€
13115	OE:G03158762	30	30	2,50€

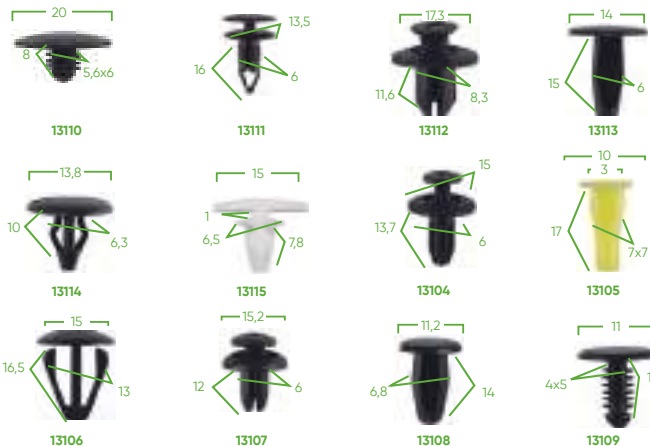

52886

18,00€



ESTUCHE DE CLIPS PLÁSTICOS TOYOTA/LEXUS 89 PCS

REF.	DESCRIPCIÓN	UNIDADES	UNIDADES POR BOLSA	€
13002	OE:9018906001	8	8	1,45€
13003	OE:9046707138	5	4	1,70€
13004	OE:9046707117	10	10	1,85€
13005	OE:9046709138	10	10	1,25€
13006	OE:9046709101	5	5	1,40€
13007	OE:75521611000	10	10	1,30€
13008	OE:7503933060	8	8	2,25€
13009	OE:9017905060	4	4	1,65€
13010	OE:677711250	8	8	1,75€
13011	OE:9046708124	5	5	1,15€
13012	OE:7539533030	8	8	1,80€
13013	OE:9046711063	8	8	1,75€



52887

22,00€



ESTUCHE DE CLIPS PLÁSTICOS HONDA 150 PCS

REF.	DESCRIPCIÓN	UNIDADES	UNIDADES POR BOLSA	€
13014	OE:75103SJ4003	12	12	1,45€
13015	OE:90675SB003	5	5	1,20€
13016	OE:91566SP0003	6	6	1,15€
13017	OE:91513SE003	25	25	2,60€
13018	OE:91530ST5003	25	25	1,45€
13019	OE:90687SA50030	15	15	1,75€
13020	OE:91620SR2003	8	8	1,70€
13021	OE:38529689A6300	8	8	1,30€
13022	OE:90683SA5003	10	10	2,10€
13023	OE:90672671003	10	10	1,50€
13024	OE:91534SEO000	18	18	2,45€
13025	OE:34355SD2003	8	8	1,50€

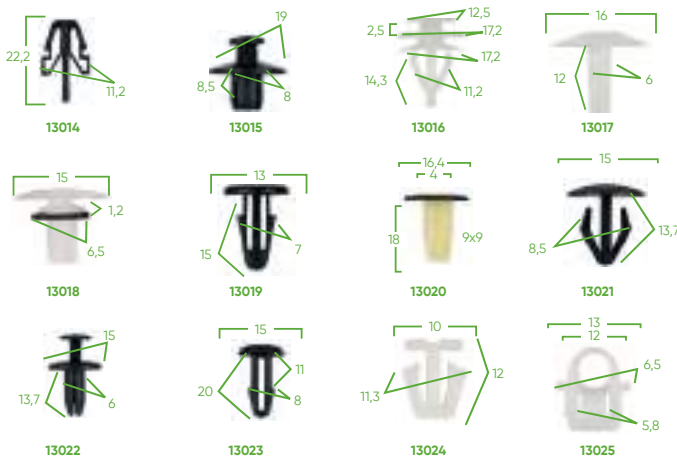

52899

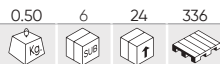

34,00€



ESTUCHE DE CLIPS PLÁSTICOS PEUGEOT/CITROËN 345 PCS

REF.	DESCRIPCIÓN		€
13128	OE:947098	50 50	1,85€
13129	OE:856535	20 20	2,00€
13130	OE:6991W4	20 20	3,75€
13131	-	20 20	3,45€
13132	OE:694143	25 25	2,65€
13133	OE:743707	35 35	3,45€
13134	OE:7703074022	30 30	3,95€
13135	OE:7703077059	35 35	3,45€
13136	OE:698317	15 15	2,60€
13137	OE:699502	25 25	2,25€
13138	OE:6995X3	30 30	2,85€
13139	OE:69945	40 40	3,85€



52900

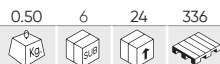

34,00€



ESTUCHE DE CLIPS PLÁSTICOS FIAT 308 PCS

REF.	DESCRIPCIÓN		€
13140	OE:14591784	30 30	2,65€
13141	OE:1459487	20 10	1,80€
13142	OE:1300433650	25 25	3,10€
13143	OE:71717421	8 8	1,95€
13144	OE:82456515	25 25	2,20€
13145	OE:5757139	25 25	3,85€
13146	-	20 8	4,50€
13147	OE:46306526	25 25	3,10€
13148	OE:14591687	25 25	3,30€
13149	OE:14592387	25 25	3,10€
13150	OE:83468473	30 30	2,25€
13151	OE:7677865	50 30	5,35€



52901

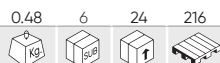

34,00€



ESTUCHE DE CLIPS PLÁSTICOS VOLVO 350 PCS

REF.	DESCRIPCIÓN		€
13152	OE:8099905N07	25 25	3,05€
13153	OE:4292906	30 30	3,10€
13154	OE:12681763	20 20	3,20€
13155	OE:51131804205	40 40	5,60€
13156	OE:947098	40 40	3,30€
13157	OE:591740	40 40	3,85€
13158	OE:6384801G00	25 25	3,75€
13159	OE:9133417	20 20	3,20€
13160	OE:9133073	40 40	5,00€
13161	OE:3272075327462B	30 30	3,55€
13162	OE:327462A	20 20	2,60€
13163	OE:3923712	20 20	2,80€

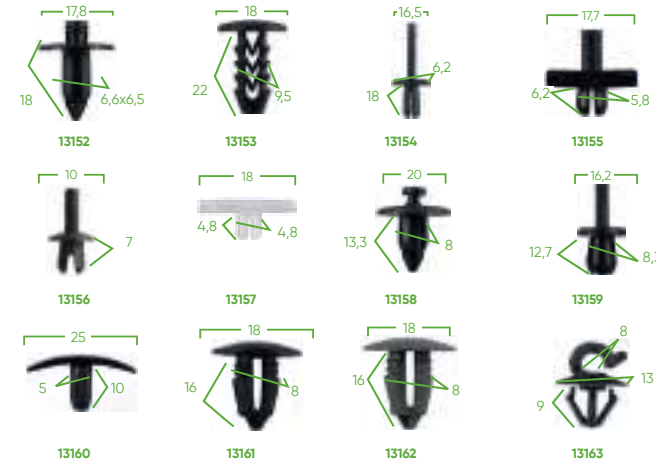

52889

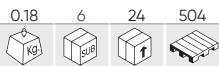

19,00€



ESTUCHE DE CLIPS PLÁSTICOS VOLKSWAGEN 85 PCS

REF.	DESCRIPCIÓN		€
13038	OE:1H0868243B	2 2	1,40€
13039	OE:N90833801	10 10	1,65€
13040	OE:3A0853575	8 8	1,80€
13041	OE:4A0853825	5 5	1,55€
13042	OE:6U085733	15 15	1,95€
13043	OE:3B0853576	3 3	1,20€
13044	OE:1H0819055B01C	6 6	1,55€
13045	OE:443853909A	5 5	1,20€
13046	OE:171885767	6 6	1,55€
13047	OE:N9020160H	5 5	1,45€
13048	OE:NO385501	10 10	2,20€
13049	OE:191941142	10 10	2,05€

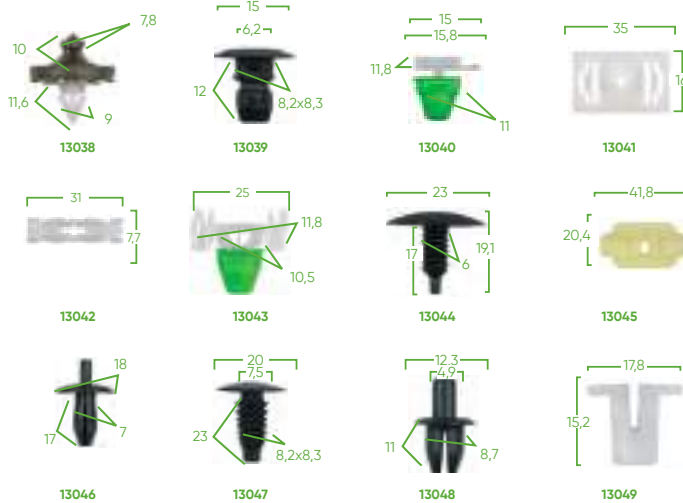

52891



28,00€



ESTUCHE DE CLIPS PLÁSTICOS FORD 169 PCS

REF.	DESCRIPCIÓN		€
13056	OE:388577S	8 8	1,55€
13057	OE:N801925S	5 5	1,50€
13058	OE:N806289S	20 20	2,20€
13059	OE:N379830S	20 20	2,35€
13060	OE:1007932	5 5	1,60€
13061	OE:16500308	20 20	2,65€
13062	OE:N803170S	20 20	2,35€
13063	OE:W706713S300	6 6	1,15€
13064	OE:N388246S	20 20	2,60€
13065	OE:F22Z16774A	15 15	2,00€
13066	OE:1673046	5 5	2,25€
13067	OE:F1CZ16674A	25 25	2,55€

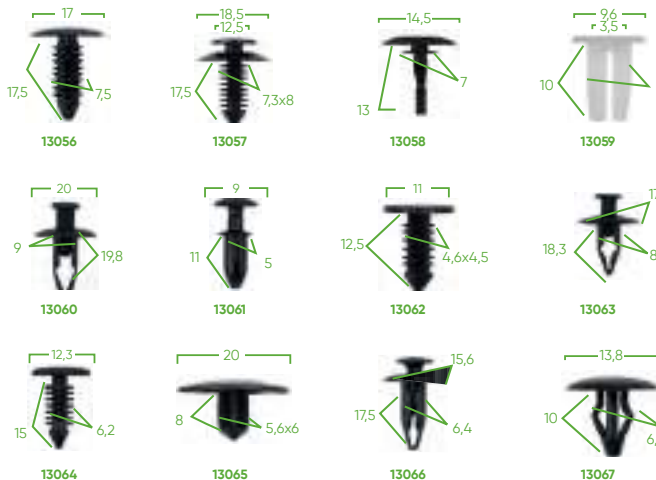

52894

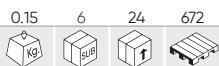

22,00€



ESTUCHE DE CLIPS PLÁSTICOS NISSAN 139 PCS

REF.	DESCRIPCIÓN		€
13080	OE:76906T300	15 15	1,75€
13081	OE:0155300172	20 20	2,30€
13082	OE:68425H5000	10 10	1,35€
13083	OE:75521611000	6 6	1,50€
13084	OE:62869N4700	20 20	2,10€
13085	OE:6384401A00	5 5	1,60€
13086	OE:7688257A00	5 5	1,25€
13087	OE:6684101G00	25 25	3,30€
13088	OE:1099830880	10 10	2,40€
13089	OE:8942798070	10 10	1,70€
13090	OE:6384801G00	8 8	1,70€
13091	OE:6385401A00	5 5	1,25€

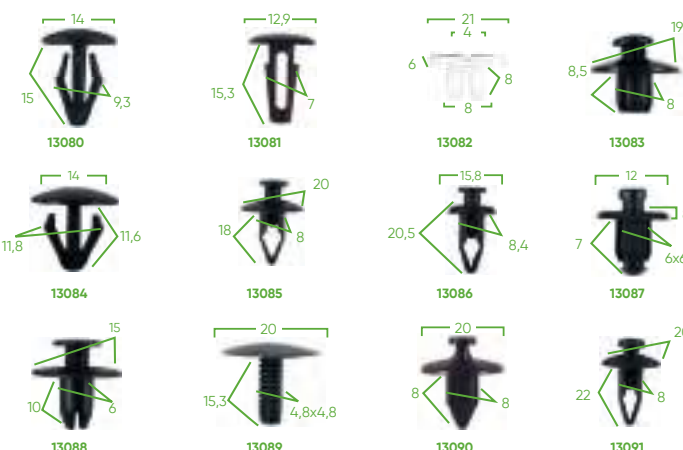

52890



22,00€



ESTUCHE DE CLIPS PLÁSTICOS AUDI 31 PCS

REF.	DESCRIPCIÓN		€
13050	OE:3B0868243	5 15	1,55€
13051	OE:1H0867199A	5 20	1,50€
13052	OE:1H0868243B	3 3	1,25€
13053	OE:357853575	10 10	2,80€
13054	OE:1H0853585A	5 5	2,35€
13055	OE:3A0853575	3 3	3,00€

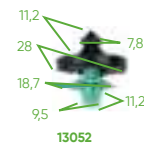

13052



13054

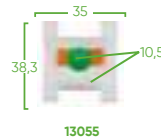

13055

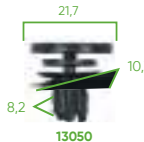

13050



13051

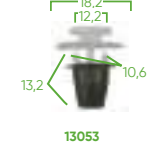

13053



52892



22,00€



ESTUCHE DE CLIPS PLÁSTICOS BMW 95 PCS

REF.	DESCRIPCIÓN		€
13068	OE:51311802258	25 25	2,85€
13069	OE:5131804205	30 30	4,55€
13070	OE:51118174185	10 10	2,15€
13071	OE:51481938725	10 10	2,05€
13072	OE:703867299	15 15	2,75€
13073	OE:51131960054	5 5	2,10€

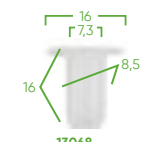

13068



13069

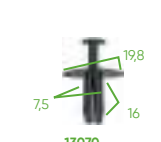

13070



13071

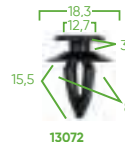

13072



13073



52897



38,00€



ESTUCHE DE CLIPS PLÁSTICOS RENAULT 300 PCS

REF.	DESCRIPCIÓN		€
13116	OE:7703077421	50 50	5,45€
13117	-	50 50	3,65€
13118	OE:7703081184	60 60	15,90€
13119	-	15 15	5,60€
13120	OE:7703074022	60 60	5,50€
13121	OE:7703077059	65 65	8,75€

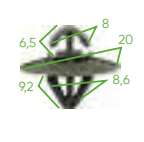

13116

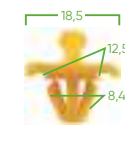

13117



13118

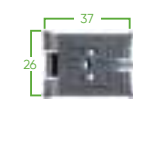

13119



13120

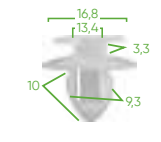

13121



52898



36,00€



ESTUCHE DE CLIPS PLÁSTICOS VAUXHALL/OPEL 300 PCS

REF.	DESCRIPCIÓN		€
13122	OE:90218614	20 20	1,95€
13123	OE:174864	40 40	5,35€
13124	OE:NO385501	100 100	8,20€
13125	OE:2345959	50 50	5,95€
13126	OE:2240582	50 50	1,55€
13127	OE:180942	40 40	5,60€

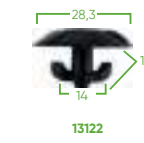

13122

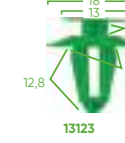

13123

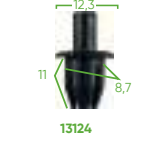

13124



13125



13126



13127



52893

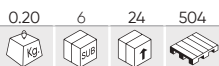

26,00€



ESTUCHE DE CLIPS PLÁSTICOS MERCEDES-BENZ 95 PCS

REF.	DESCRIPCIÓN	Paquete	Unidad	€
13074	OE:A0019884481	30	30	4,65€
13075	OE:A0019882981	20	20	5,35€
13076	OE:A1249900492	15	15	3,90€
13077	OE:A0019888081	4	4	2,55€
13078	OE:A1249880492	6	6	2,55€
13079	OE:A0019880325	20	20	3,35€

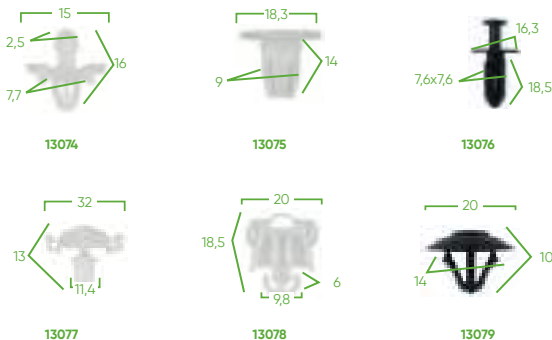

52895



22,00€



ESTUCHE DE CLIPS PLÁSTICOS MITSUBISHI 134 PCS

REF.	DESCRIPCIÓN	Paquete	Unidad	€
13092	OE:8942180270	15	50	1,65€
13093	OE:9018905013	30	30	2,95€
13094	OE:MU480033	10	10	1,50€
13095	OE:128100231	8	6	1,20€
13096	OE:MU480034	8	8	1,70€
13097	OE:MR138807	3	3	1,20€
13098	OE:MB253964	4	4	1,65€
13099	OE:HB121467	30	30	2,75€
13100	OE:MB271999	3	3	1,20€
13101	OE:MB696120	8	8	1,50€
13102	OE:MR200300	5	5	1,60€
13103	OE:MB846992	10	10	1,80€

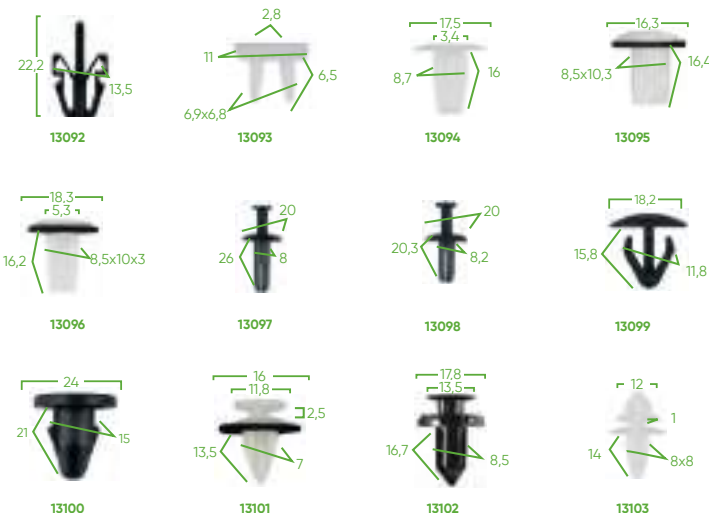

52888



24,00€



ESTUCHE DE CLIPS PLÁSTICOS UNIVERSAL 128 PCS

REF.	DESCRIPCIÓN	Paquete	Unidad	€
13026	OE:388577S	8	8	1,55€
13027	-	10	10	1,85€
13028	OE:6003423	6	6	1,45€
13029	OE:VW:N989022 CHRYSLER: 6003349 FORD:385661	6	6	1,65€
13030	OE:CHRYSLER: 6502328 GM:20699808	25	25	2,80€
13031	OE:N804379S	4	4	1,85€
13032	OE:FORD:F22Z16774A MAZDA:6508197AA	15	15	2,00€
13033	OE:GM:16674629 FORD:N806113S	10	10	1,60€
13034	OE:0153301781	20	20	2,65€
13035	OE:GM:10124502 BMW:52201964201 LAND ROVER:- DZM10080	6	6	1,65€
13036	OE:VW:N9020160H BMW:51471904317 OPEL:2207713	6	6	1,40€
13037	-	12	12	2,10€

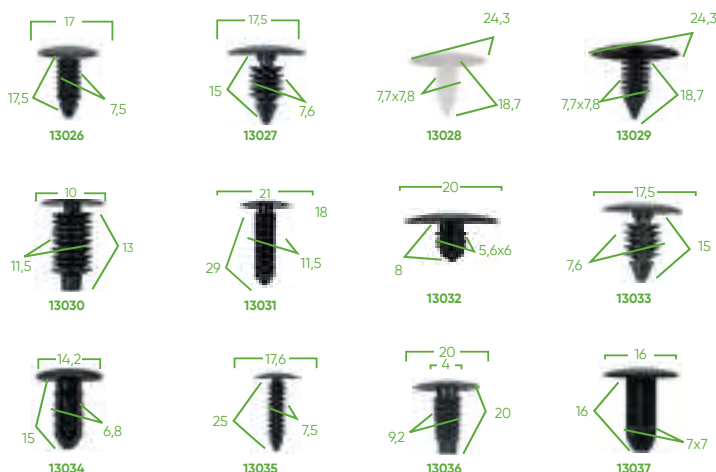

53720

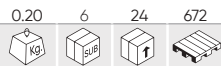

19,00€



ESTUCHE DE CLIPS BMW MINI 112 PCS PARA TAPICERÍA

REF.	DESCRIPCIÓN	Q	U	€
14447	OE: 51471911992	7	6	1,45€
14449	OE: 51717002953	13	10	2,20€
14471	OE: 51489119216	5	5	1,90€
14472	OE: A0009905492	5	5	1,35€
14474	OE: 51118174185	8	8	1,50€
14475	OE: 2019900050	6	6	1,65€
14476	OE: 51481915964	9	9	2,05€
14477	OE: 0009881625	15	15	2,45€
14478	OE: 7146976114	15	15	4,05€
14479	OE: 91503SP0003	6	6	1,65€
14480	-	15	15	2,05€
14481	OE: 51161943122	8	8	1,70€

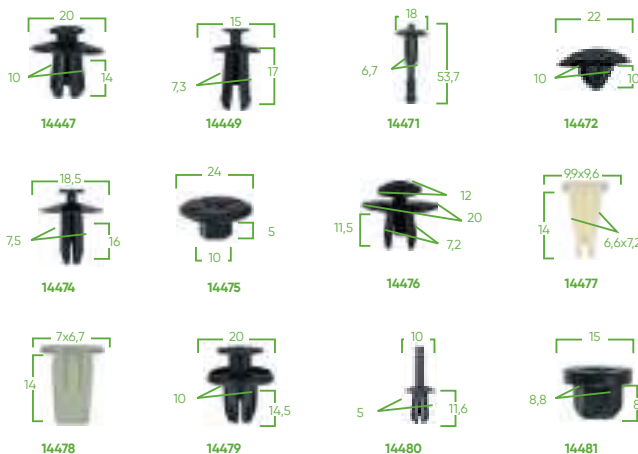

53719

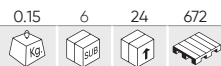

19,00€



ESTUCHE DE CLIPS BMW MINI 92 PCS PARA PANEL DE PUERTA/MOLDURA

REF.	DESCRIPCIÓN	Q	U	€
14359	-	8	8	1,05€
14458	-	6	6	1,70€
14459	OE: 7147122912	2	2	1,45€
14460	OE: 51411973500	8	8	1,15€
14461	-	8	8	1,35€
14462	-	8	8	1,65€
14463	OE: 611769	10	10	1,65€
14464	OE: 7147145753	10	10	1,50€
14465	-	8	8	2,00€
14466	OE: 51418224768	8	4	1,65€
14468	-	8	8	1,30€
14469	OE: 7147133419	8	8	1,45€

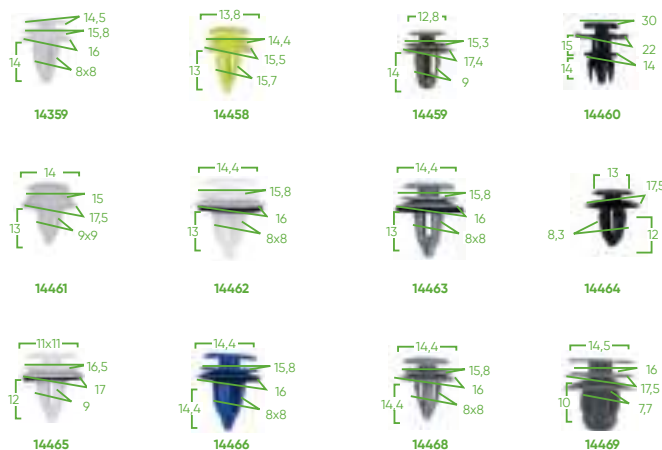

53718

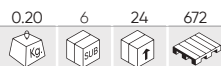

19,00€



ESTUCHE DE CLIPS MERCEDES-BENZ 151 PCS PARA TAPICERÍA

REF.	DESCRIPCIÓN	Q	U	€
14422	OE: A0009913940	20	20	1,50€
14446	OE: 9903492	6	6	2,80€
14447	OE: 51471911992	12	12	1,45€
14448	OE: N105835019B9	10	10	2,05€
14449	OE: A0009905492	12	12	2,20€
14450	OE: N0385012	12	12	2,15€
14451	OE: A1239900092	25	25	2,15€
14452	-	20	20	2,55€
14453	-	6	6	3,05€
14455	-	12	12	2,10€
14456	-	6	6	1,35€
14457	OE: A1249900492	10	10	1,70€

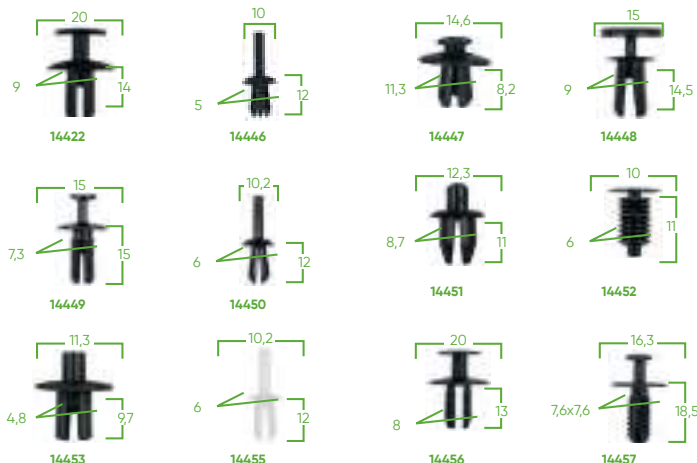

53717

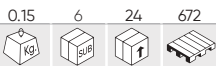

19,00€



ESTUCHE DE CLIPS MERCEDES-BENZ 96 PCS PARA PANEL DE PUERTA/MOLDURA

REF.	DESCRIPCIÓN	8	8	€
14434	-	8	8	1,60€
14435	-	6	6	1,45€
14436	OE: A0009910198	8	8	1,70€
14437	OE: A0019912698	6	6	1,45€
14438	OE: A0089880978	8	8	1,35€
14439	OE: 0069884378	8	8	1,75€
14440	-	8	8	1,75€
14441	OE: 0019884981	10	10	1,65€
14442	-	6	6	1,45€
14443	-	8	8	1,45€
14444	OE: 0019886081	10	10	1,90€
14445	-	10	10	1,45€

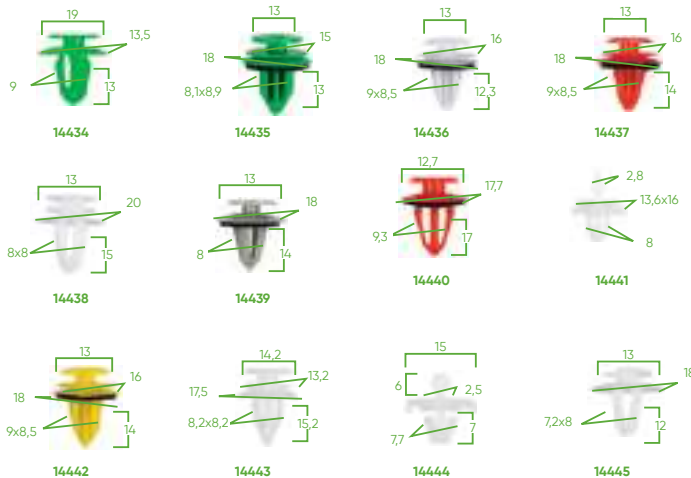

53716



19,00€



ESTUCHE DE CLIPS VAG/SEAT/SKODA 79 PCS PARA PANEL DE PUERTA/MOLDURA /TAPICERÍA

REF.	DESCRIPCIÓN	6	6	€
14422	OE: A0009913940	6	6	1,50€
14423	OE: 6E0837732	15	15	3,55€
14424	-	7	7	1,85€
14425	OE: 6Q0868243	2	2	2,05€
14426	OE: 171201969	8	8	1,90€
14427	OE: 4D0807300	8	4	1,20€
14428	OE: 251823717	12	12	1,40€
14429	-	6	6	1,80€
14430	OE: 8E0821989A	3	3	2,25€
14431	OE: 3B0868243	2	2	1,45€
14432	OE: 1H0823171	10	10	1,45€

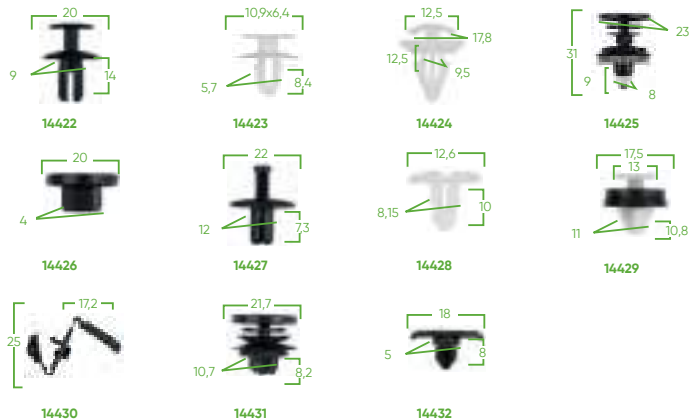

53715

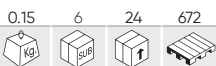

19,00€



ESTUCHE DE CLIPS PEUGEOT/CITROËN 110 PCS PARA TAPICERÍA

REF.	DESCRIPCIÓN	10	10	€
14410	-	10	10	1,85€
14411	-	10	5	1,70€
14412	-	10	10	1,70€
14413	-	10	10	3,25€
14414	OE: 2346824	10	10	1,70€
14415	OE: A1249900492	10	10	1,70€
14416	OE: 6992C6	10	5	1,25€
14419	-	15	15	1,95€
14420	-	15	15	1,50€
14421	OE: 14093311	10	10	2,45€

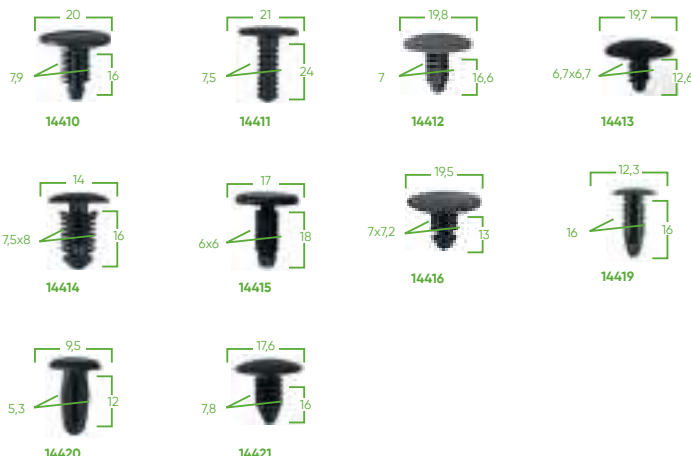

53714

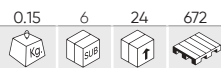

16,00€



ESTUCHE DE CLIPS PEUGEOT/CITROËN 80 PCS PARA MOLDURA

REF.	DESCRIPCIÓN			€
14398	OE: 6995X3	8	8	1,30€
14399	OE: 129943	12	6	1,90€
14402	OE: 856548	8	8	1,50€
14404	OE: 71728806	8	8	2,10€
14405	OE: 968865987703	16	8	1,45€
14406	OE: 856540	10	10	1,55€
14408	OE: 856534	10	10	1,45€
14409	OE: 357853586	8	8	1,35€

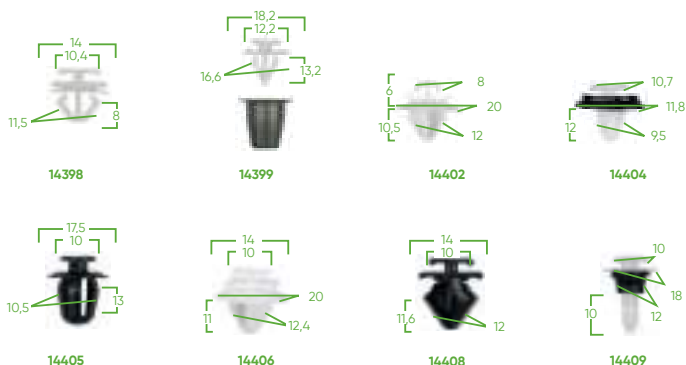

53713



16,00€



ESTUCHE DE CLIPS PEUGEOT/CITROËN 93 PCS PARA PANEL DE PUERTA

REF.	DESCRIPCIÓN			€
14350	OE: 6991Y8	6	6	1,80€
14358	OE: PG 6991Y8 CT 6991Y8 FIAT 9654280780 RENAULT 703077469	10	10	1,70€
14387	-	8	8	1,45€
14388	OE: 7703077250	8	8	2,05€
14389	OE: 6995A3	6	6	1,25€
14390	-	6	6	1,35€
14391	-	15	15	2,15€
14392	-	6	6	1,35€
14393	-	8	8	1,50€
14395	-	8	8	1,65€
14396	-	6	6	1,20€
14397	-	6	6	1,45€

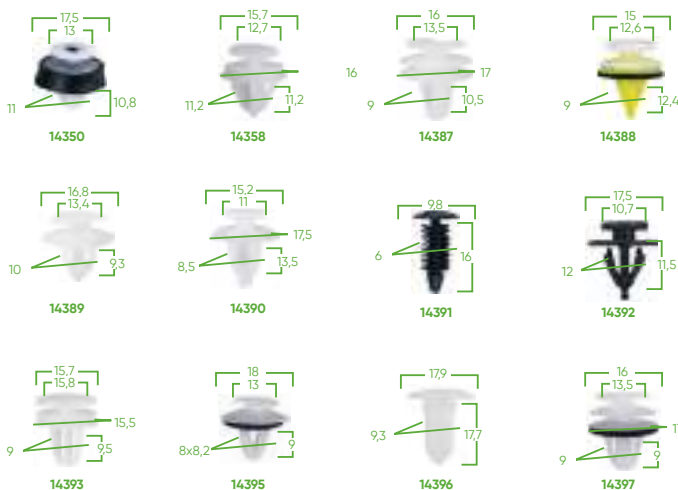

53712

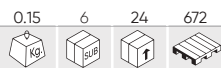

16,00€



ESTUCHE DE CLIPS RENAULT DACIA 109 PCS PARA TAPICERÍA

REF.	DESCRIPCIÓN			€
14374	OE: 7703077435	3	3	1,70€
14375	-	15	15	1,85€
14376	OE: 7L6868307	20	20	2,60€
14377	-	10	10	1,90€
14378	OE: 7703077117	12	12	1,90€
14379	-	6	6	1,45€
14381	-	10	10	1,70€
14382	OE: 7703077153	6	6	1,85€
14383	OE: 7703072360	10	10	1,35€
14384	OE: W705956S300	12	12	2,10€
14416	OE: 6992C6	5	5	1,25€

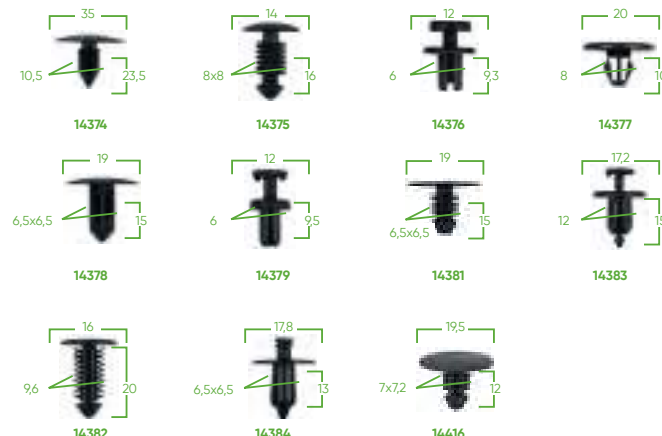

53711

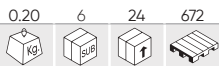

16,00€



ESTUCHE DE CLIPS RENAULT DACIA 90 PCS PARA MOLDURA

REF.	DESCRIPCIÓN	10	10	€
14356	OE: RENAULT 7703077368 OPEL 4430858	10	10	1,90€
14358	OE: PG 6991Y8 CT 6991Y8 FIAT 9654280780 RENAULT 703077469	12	10	1,70€
14364	OE: OP 7701470779 NI 7703077421 RENUALT 7703077421 IV 500326896	10	10	1,90€
14365	OE: OP 7701470779 NI 7703077421 RENUALT 7703077421 IV 500326896	10	10	1,90€
14366	OE: PG 6991Y8 CT 6991Y8 FIAT 9654280780 RENAULT 703077469	8	8	1,45€
14367	-	3	3	1,30€
14368	OE: 7L5853994	8	8	1,45€
14369	OE: 7701061797	15	15	4,95€
14370	-	3	3	3,00€
14371	-	3	3	3,00€
14372	-	4	4	1,20€
14373	-	4	4	1,35€



53710



16,00€



ESTUCHE DE CLIPS RENAULT DACIA 85 PCS PARA PANEL DE PUERTA

REF.	DESCRIPCIÓN	12	6	€
14350	OE: 6991Y8	12	6	1,80€
14351	-	8	15	1,65€
14352	OE: 51447780135	7	7	1,30€
14353	OE: 7703077476	8	2	2,10€
14355	OE: 7703077354	8	8	1,70€
14356	OE: RENAULT 703077368 OPEL 4430858	10	4	1,90€
14357	OE: 7703077430	10	12	1,90€
14358	OE: PG 6991Y8 CT 6991Y8 FIAT 9654280780 RENAULT 703077469	10	6	1,70€
14359	OE: 51418224768	4	3	1,05€
14361	-	8	15	1,70€

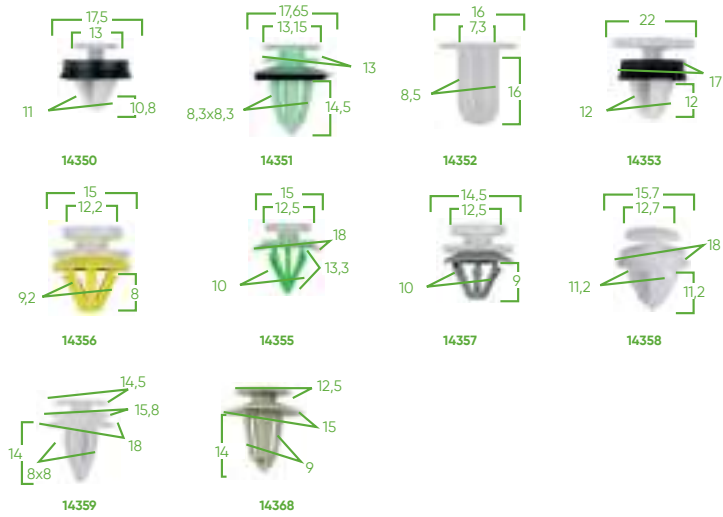

ROPA LABORAL

406 CHALECOS

406 CHAQUETAS





CHALECOS JBM



REF.		■	■	■	📦	📦	📦	🚚	€
70001	M	●			0.30	-	5	200	35,00€
70002	L	●			0.40	-	5	200	35,00€
70003	XL	●			0.40	-	5	200	35,00€
70009	XL		●		0.40	-	5	180	35,00€
70013	S		●		0.30	-	10	240	44,00€
70014	M		●		0.30	-	10	240	44,00€
70015	L		●		0.30	-	10	240	44,00€
70016	XL		●		0.35	-	10	240	44,00€
70017	XXL		●		0.35	-	10	200	44,00€

CHAQUETAS JBM



REF.		■	■	■	📦	📦	📦	🚚	€
70004	M	●			0.60	-	5	140	42,00€
70005	L	●			0.70	-	5	140	42,00€
70006	XL	●			0.70	-	5	140	42,00€
70011	L		●		0.60	-	5	120	42,00€
70012	XL		●		0.70	-	5	120	42,00€

13929

3,45€



PERCHA 49CM



METEXP

62,00€



EXPOSITOR JBM



PROMOCIONALES

408 PRODUCTOS PROMOCIONALES

410 EXPOSITORES / ACCESORIOS

412 PACKAGING



PROMOCIONALES

53956

353,00€

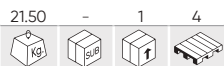

SILLA GIRATORIA

MEDIDAS: 70x55x126-136cm

ALTURA REGULABLE

COJÍN LUMBAR

COJÍN REPOSACABEZAS



MATERIAL: Poliuretano
GROSOR ESTRUCTURA DE ACERO: 1,2cm
ESPUMA DEL ASIENTO: Espuma moldeada
ESPUMA DEL RESPALDO: Espuma primaria
APOYABRAZOS: 2D
PISTÓN ELEVADOR: Clase 3
BASE DE NYLON: 350mm



DESPIECE DISPONIBLE

54043

48,00€

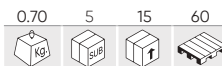

MOCHILA JBM

ESPACIO DE ALMACENAMIENTO:
 Con un total de dos compartimentos tiene capacidad para ordenadores portátiles de menos de 17.3 pulgadas y tablets, entre otros.

MATERIAL:
 Poliuretano, es una mochila impermeable, sólida y resistente

LIGERA Y CÓMODA:
 Diseño de malla de esponja cómoda y transpirable de la espalda y las correas.



53973

284,00€



CARPA STAND PLEGABLE JBM 3X3M

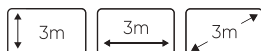

15152

160,00€



LATERAL PARA CARPA STAND PLEGABLE JBM 3X3M (REF. 53973)

Consta de dos partes:
 - Parte lateral que cubre 3/4 partes de la carpa.
 - Parte delantera que cubre 1/4 parte de la carpa, con cremallera vertical a modo de puerta.



REF.	DESCRIPCIÓN	Icon	Icon	Icon	Icon	€
14347	FUNDA PARA CARPA STAND JBM	0.60	-	5	-	36,50€

54325 22,50€



N

ALFOMBRA 100X65CM



54278 4,50€



N

GORRA JBM



54480 1,00€



N

LLAVERO JBM



53949 4,50€



BOLSA NEVERA JBM NEGRA



53950 4,50€



BOLSA NEVERA JBM VERDE

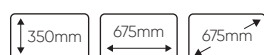

13968 1,35€

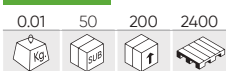

BOLSA PROMOCIONAL JBM



53533 1,50€



BOLÍGRAFO DE 4 COLORES PUBLICITARIO JBM



54076 9,00€



TAZA JBM



340ml



PROMOCIONALES

53504

38,00€

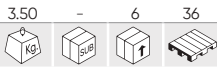

PATINETE DE 2 RUEDAS - SCOOTER

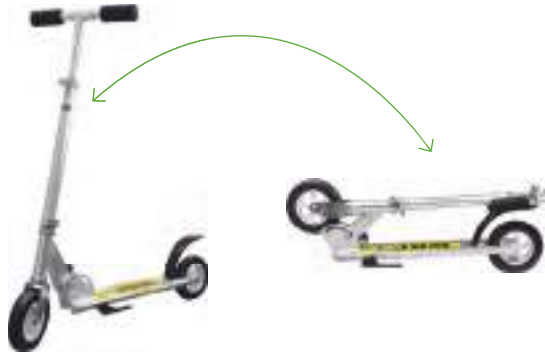

14975

64,00€



JAMONERO



GANCHOS PARA EXPOSITORES

REF. PARA					€	
14034	HERRAMIENTAS NEUMÁTICAS	0.20	20	80	1920	9,00€
14623	REF. 60046, 60044, 60048, 60005, 60006	0.10	-	10	800	8,00€
14626	REF. 60023	0.10	-	10	-	7,00€
11318	GANCHO DE UNA PUNTA 100MM	0.04	20	600	-	2,50€
16364	GANCHO DE PUNTA LARGO 280MM	0.20	-	200	-	3,50€
51315	GANCHO DE PUNTA CERRADA 100MM	0.02	20	320	44800	2,50€

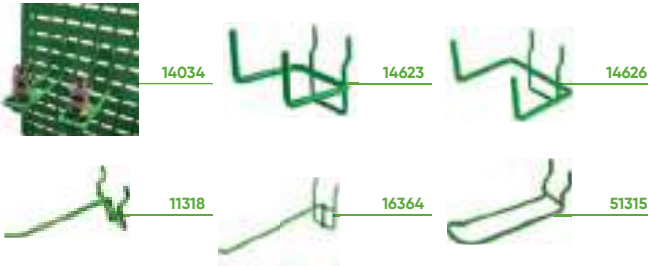

BANDEJAS DE SOPORTE PARA EXPOSITORES

REF. PARA					€	
14622	REF. 60001, 60003, 60004, 60020	0.95	-	10	360	17,00€
14624	REF. 60007, 60010, 60011	0.65	-	10	300	17,00€
14625	REF. 60028, 60009	0.50	-	10	700	14,00€



53492

380,00€

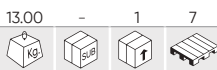

EXPOSITOR DE HERRAMIENTAS NEUMÁTICAS



HERRAMIENTAS NO INCLUIDAS



METEXP

62,00€

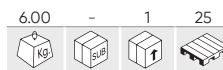

EXPOSITOR JBM



REF.	DESCRIPCIÓN					€
13929	PERCHA 49CM	0.10	-	-	280	3,45€



53877

42,00 - 1 -

430,50€

EXPOSITOR DE HERRAMIENTAS

53878

52,15 - 1 -

574,00€

EXPOSITOR DE HERRAMIENTAS + CABEZAL CON ILUMINACIÓN

53879

83,25 - 1 -

838,50€

EXPOSITOR DE HERRAMIENTAS + CABEZAL CON ILUMINACIÓN Y PUERTA



CONTIENE

14945	x1
14346	x1
14380	x1
11318	x20



CONTIENE

14945	x1
14947	x1
14380	x1
11318	x20



CONTIENE

14945	x1
14947	x1
14948	x1
14996	x1
11318	x20



DESPIECE EXPOSITORES

REF.	DESCRIPCIÓN					€
14945	EXPOSITOR DE HERRAMIENTAS - BASE	37.80	-	1	15	303,50€
14946	CABEZAL PARA EXPOSITOR DE HERRAMIENTAS	3.40	-	1	51	58,00€
14947	CABEZAL CON ILUMINACIÓN PARA EXPOSITOR DE HERRAMIENTAS	8.55	-	1	6	201,50€
14948	CONJUNTO DE DOS PUERTAS PARA EXPOSITOR DE HERRAMIENTAS	31.10	-	1	40	251,50€
14380	BANDEJA PARA EXPOSITOR DE HERRAMIENTAS	5.00	-	1	34	51,00€
14996	BANDEJA PARA EXPOSITOR DE HERRAMIENTAS CON PUERTA	5.00	-	1	33	65,00€

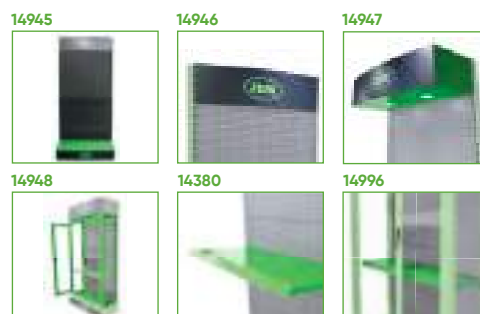

PROMOCIONALES

53914
75,00€

POSTE DE SEPARACIÓN CON CINTA RETRÁCTIL

- Material: Acero
- Diámetro del tubo: 63mm
- Diámetro de la base: 320mm
- Altura: 910mm
- Salida de cinta en 4 direcciones
- Largo de la cinta: 3m
- Ancho de cinta: 48mm

14807
11,00€

PRECINTO DE GARANTÍA JBM



MULTI-IDIOMA

- 75mm ancho x 125m largo
- Fabricado en Polipropileno
- Adhesivo solvente
- Grosor: 28 micras

CAJAS DE CARTÓN JBM

CAJAS PARA DESPIECE DE HERRAMIENTAS MANUALES

REF. DESCRIPCIÓN				€
14922 CAJA PARA DESPIECE DE HERRAMIENTAS MANUALES 14,5X9X10CM	0.10	100	-	0,84€
14923 CAJA PARA DESPIECE DE HERRAMIENTAS MANUALES 17,5X9X7CM	0.10	100	-	0,84€
14924 CAJA PARA DESPIECE DE HERRAMIENTAS MANUALES 24X11X7CM	0.10	100	-	0,84€
14925 CAJA PARA DESPIECE DE HERRAMIENTAS MANUALES 31,5X13X4CM	0.10	100	-	0,84€
14926 CAJA PARA DESPIECE DE HERRAMIENTAS MANUALES 32X8,5X7CM	0.10	100	-	1,05€



CAJAS PROMOCIONALES

REF. DESCRIPCIÓN				€
13717 CAJA JAMONERA JBM 76X14X29CM	0.90	1	200	7,65€
14083 CAJA DE CARTÓN VERDE PROMO JBM 80X28X49CM	1.80	1	100	13,20€
14976 CAJA DE CARTÓN LOTE PROMOCIONAL 80X31X61CM	2.20	1	80	18,84€
15056 CAJA DE CARTÓN PROMOCIONAL 40X30X61CM	1.60	1	70	11,70€



CAJAS JBM

REF. DESCRIPCIÓN				€
11330 CAJA DE CARTÓN JBM PEQUEÑA 19X10X11CM (FUELLE)	0.05	50	4200	0,57€
12950 CAJA DE CARTÓN JBM 60X40X30CM	0.80	15	75	3,45€
12952 CAJA DE CARTÓN JBM 40X30X20CM	0.40	20	240	1,92€
13217 CAJA DE CARTÓN 57X30X25CM (KITS DE EMERGENCIA)	0.55	15	150	1,31€
14974 CAJA DE CARTÓN JBM 54X24X40CM (20 KITS FUELLE)	0.65	20	240	2,28€
15051 CAJA DE CARTÓN JBM 40X32X30CM	0.40	20	160	1,92€
14189 PALLET BOX AMERICANO TRIPLE CANAL	10.00	1	40	52,00€
14507 PALLET BOX EUROPEO	8.00	1	40	50,00€



LEYENDA











LOGÍSTICA

 PESO EN KILOGRAMOS	 CANTIDAD POR SUBCAJA	 CANTIDAD POR CAJA	 CANTIDAD POR PALET
 CANTIDAD POR BOLSA	 CANTIDAD POR ESTUCHE	 PRESENTACIÓN EN EXPOSITOR	

GENERAL

 NÚMERO DE PIEZAS	 PRESENTACIÓN EN BLISTER	 IMANTADO	 TÁCTIL
 DURACIÓN DE CARGA DE LA BATERÍA	 DURACIÓN DE LA BATERÍA	 MANGO ERGONÓMICO	 NO SE PUEDE LAVAR
 PROTEGE DE LA LLUVIA Y LA HUMEDAD	 PRODUCTO RECICLABLE	 INFORMACIÓN	 INALÁMBRICO
 COCHE ELÉCTRICO	 SEÑALIZACIÓN DE ALTA TENSIÓN	 REGLAMENTO EUROPEO	 REGLAMENTO AMERICANO
 UNIVERSAL	REGLAMENTO UNIVERSAL		



















UNIDADES DE MEDIDA

 LONGITUD	 MASA	 DIÁMETRO	 OTROS
 CAPACIDAD	 PULGADAS	 MÁXIMO - MÍNIMO	 GRADOS
 SUPERFICIE	 GRADOS CENTÍGRADOS	 NIVEL DE RUIDO	

UNIDADES DE MEDIDA ARTÍCULOS ESPECÍFICOS

 DIÁMETRO DE DISCO	 DIÁMETRO DEL AGUJERO	 DIÁMETRO INTERIOR DEL TUBO	 DIÁMETRO INTERIOR Y EXTERIOR DEL TUBO
 LONGITUD DE LA MANGUERA	 LONGITUD DEL ENCHUFE		

MATERIALES

 MADERA	 ACERO	 ACERO S2	 ALUMINIO
 COBRE	 CROMADO	 CROMO VANADIO	 CROMO MOLIBDENO
 NEODYMIUM	 ZINC	 POLICLORURO DE VINILO	 POLIPROPILENO
 POLIETILENO	 POLIETILENO DE ALTA DENSIDAD	 ACERO LAMINADO	 LATÓN
 LATEX	 NYLON	 CAUCHO DE NITRILO BUTADIENO HIDROGENADO	

TAMBIÉN PUEDES ENCONTRAR

 ALBAÑILERIA	 MADERA	 ACERO
--	--	---









ESPECIFICACIONES TÉCNICAS

HERRAMIENTAS MANUALES

PUNTAS

 PUNTA PLANA	 PUNTA PHILIPS	 PUNTA POZIDRIV	 PUNTA TORQ
 PUNTA RIBE	 CUATRI PUNTA	 TRI PUNTA	 PUNTA ALLEN
 PUNTA TORX	 PUNTA DE DOCE CANTOS	 PUNTA CUADRADA	 TORX CINCO PUNTAS
 PUNTA SPLINE	 PUNTA MARIPOSA	 PUNTA ALLEN INVIOLEBLE	 PUNTA TORX INVIOLEBLE
 PUNTA DE DOCE CANTOS INVIOLEBLE	 PUNTA CUADRADA INVIOLEBLE	 TORX CINCO PUNTAS INVIOLEBLE	 PUNTA SPLINE INVIOLEBLE
 PUNTA TENSOR			

VASOS

 VASO HEXAGONAL	 VASO TORX	 VASO DOCE CANTOS	 VASO CUADRADO
 VASO TORX DE CINCO PUNTAS	 VASO SPLINE	 VASO HEXAGONAL INVIOLEBLE	 VASO TORX INVIOLEBLE
 VASO DOCE CANTOS INVIOLEBLE	 VASO CUADRADO INVIOLEBLE	 VASO TORX DE CINCO PUNTAS INVIOLEBLE	 VASO SPLINE INVIOLEBLE

LLAVES

 LLAVE HEXAGONAL	 LLAVE TORX DE CINCO PUNTAS	 LLAVE DOCE CANTOS	 LLAVE CUADRADA
 LLAVE DE CINCO PUNTAS			

















CARRACAS

 24 DIENTES	 72 DIENTES	 90 DIENTES
--	--	--

HERRAMIENTAS ELÉCTRICAS

 WATTS	 VATIOS	 HERTZ	 KILOVATIO
 AMPERIOS	 CORRIENTE ALTERNA	 CORRIENTE CONTINUA	 RESISTENCIA ELECTRICA
 BATERÍA DE IONES DE LITIO	 USB MICROUSB	 TOMA DE MECHERO	

HERRAMIENTAS NEUMÁTICAS

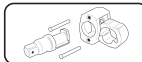
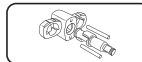
 UNIDAD DE PRESIÓN	 UNIDAD DE PRESIÓN	 PIES CÚBICOS POR MINUTO (FLUJO)	 CABALLOS DE FUERZA (POTENCIA)
 REVOLUCIONES POR MINUTO GENERAL	 REVOLUCIONES POR MINUTO INVERSA	 REVOLUCIONES POR MINUTO ADELANTE	 NEWTON MÁXIMO POR METRO
 NEWTON POR METRO	 PULSOS POR MINUTO	 KILOPASCAL	 MEGAPASCAL
 ALTO VOLUMEN DE AIRE Y BAJA PRESIÓN	 SALIDA TRASERA	 CONECTABLE A MANGUERA	 ENTRADA DE AIRE
 CAPACIDAD DE VELOCIDAD	 SISTEMA MARTILLO JUMBO	 MECANISMO DOBLE MARTILLO	

ÍNDICE NUMÉRICO

REF.	PÁGINA	PRECIO
10000	305	7,00 €
10054	232	2,90 €
10055	232	3,90 €
10264	53	2,00 €
10485	231	8,10 €
10486	231	8,00 €
10494	231	6,50 €
10495	231	3,00 €
10496	231	3,00 €
10497	231	3,00 €
10498	231	3,00 €
10499	231	3,00 €
10500	231	3,00 €
10501	231	8,10 €
10502	231	3,50 €
10526	57	10,00 €
10531	41	3,00 €
10532	41	2,70 €
10533	41	3,00 €
10534	41	3,25 €
10535	41	3,50 €
10536	41	3,65 €
10537	41	3,90 €
10538	41	4,30 €
10539	41	4,75 €
10540	41	5,25 €
10541	41	5,55 €
10542	41	5,85 €
10543	41	7,00 €
10544	41	8,10 €
10545	41	9,75 €
10546	41	11,60 €
10547	41	13,50 €
10548	41	1,75 €
10549	41	2,00 €
10550	41	2,15 €
10551	41	2,15 €
10552	38	7,10 €
10553	38	7,35 €
10554	38	7,50 €
10555	38	7,80 €
10556	38	8,10 €
10557	38	8,10 €
10558	38	9,35 €
10559	38	9,50 €
10560	38	10,60 €
10561	38	11,00 €
10562	38	12,30 €
10563	38	12,50 €
10564	42	2,50 €
10565	42	3,50 €
10566	42	3,50 €
10567	42	3,50 €

REF.	PÁGINA	PRECIO
10568	42	4,00 €
10569	42	4,50 €
10570	42	4,50 €
10571	42	5,00 €
10579	42	3,00 €
10580	42	3,10 €
10581	42	3,40 €
10582	42	4,00 €
10583	42	4,15 €
10584	42	5,05 €
10585	42	6,75 €
10586	42	7,60 €
10587	42	9,80 €
10588	42	10,50 €
10589	42	2,00 €
10590	42	2,40 €
10591	44	2,50 €
10592	44	2,55 €
10593	44	3,15 €
10594	44	3,20 €
10595	44	3,35 €
10596	44	4,25 €
10597	44	4,50 €
10598	44	4,60 €
10599	44	6,00 €
10600	44	6,25 €
10601	44	6,50 €
10602	44	7,05 €
10603	44	2,10 €
10604	44	2,25 €
10617	46	14,10 €
10618	46	15,10 €
10619	46	15,70 €
10620	46	16,20 €
10621	46	9,50 €
10622	46	10,00 €
10623	46	12,60 €
10624	46	13,50 €
10625	46	15,70 €
10626	46	17,80 €
10627	44	2,80 €
10628	44	3,10 €
10629	44	3,65 €
10630	44	3,90 €
10631	44	4,20 €
10632	44	5,30 €
10633	44	6,60 €
10634	44	7,80 €
10635	44	8,15 €
10636	44	8,80 €
10637	44	12,10 €
10638	44	12,70 €
10642	57	10,00 €

REF.	PÁGINA	PRECIO
10643	57	10,00 €
10644	57	10,00 €
10672	242	9,50 €
10673	242	9,50 €
10674	242	9,50 €
10675	242	9,50 €
10732	89	18,70 €
10735	89	20,30 €
10750	139	13,00 €
10751	139	15,00 €
10766	139, 357	1,59 €
10772	386	0,05 €
10773	386	0,10 €
10774	386	0,10 €
10775	386	0,15 €
10776	386	0,20 €
10777	386	0,20 €
10778	386	0,35 €
10779	385, 386	0,05 €
10780	385, 386	0,05 €
10781	385, 386	0,05 €
10782	386	0,05 €
10783	386	0,05 €
10784	385, 386	0,05 €
10785	385, 386	0,10 €
10786	385, 386	0,15 €
10787	386	0,05 €
10788	386	0,05 €
10789	386	0,05 €
10790	386	0,05 €
10791	386	0,05 €
10792	386	0,05 €
10793	382	0,25 €
10794	382	0,40 €
10795	382	0,60 €
10796	382	0,07 €
10797	382	0,09 €
10798	382	0,12 €
10799	382	0,13 €
10800	382	0,15 €
10801	382	0,17 €
10802	382	0,19 €
10803	382	0,05 €
10804	382	0,22 €
10805	385	0,10 €
10812	385	0,30 €
10813	385	0,30 €
10823	388	0,20 €
10824	388	0,20 €
10825	388	0,20 €
10826	388	0,40 €
10827	388	0,60 €
10828	388	0,45 €

REF.	PÁGINA	PRECIO
10829	388	0,20 €
10830	388	0,20 €
10831	388	0,20 €
10832	388	0,20 €
10833	388	0,20 €
10834	388	0,25 €
10835	388	0,25 €
10836	388	0,30 €
10837	388	0,30 €
10838	388	0,30 €
10839	388	0,40 €
10840	388	0,35 €
10868	390	0,30 €
10869	390	0,30 €
10870	390	0,45 €
10871	390	0,30 €
10872	390	0,40 €
10873	390	0,45 €
10874	390	0,30 €
10875	390	0,40 €
10876	390	0,45 €
10877	384	0,25 €
10878	384	0,30 €
10879	384	0,20 €
10880	384	0,20 €
10881	384	0,25 €
10882	382	0,25 €
10883	382	0,25 €
10884	382	0,25 €
10885	394	0,20 €
10886	394	0,20 €
10887	394	0,25 €
10888	394	0,30 €
10889	394	0,30 €
10890	394	0,35 €
10891	394	0,25 €
10892	394	0,30 €
10893	394	0,25 €
10894	394	0,20 €
10895	394	0,20 €
10896	394	0,30 €
10897	394	0,30 €
10898	394	0,30 €
10899	394	0,30 €
10900	394	0,30 €
10901	394	0,25 €
10902	394	0,30 €
10905	394	0,25 €
10906	394	0,25 €
10907	394	0,25 €
10908	394	0,30 €
10909	394	0,30 €
10910	394	0,30 €

REF.	PÁGINA	PRECIO
10911	394	0,30 €
10912	394	0,25 €
10913	394	0,30 €
10914	394	0,25 €
10915	393, 394	0,25 €
10916	394	0,30 €
10917	393, 394	0,30 €
10918	393, 394	0,30 €
10919	393, 394	0,30 €
10920	393, 394	0,25 €
10921	393, 394	0,30 €
10923	134	1,10 €
10953	229	12,50 €
10955	200	11,00 €
10961	144	13,00 €
10964	190, 350	9,00 €
10965	190, 350	6,00 €
10966	190, 350	13,50 €
11103	139	6,00 €
11106	202	3,00 €
11107	144	4,50 €
11121	168, 169, 176	4,10 €
11122	168, 169, 176	5,45 €
11123	168, 176	6,50 €
11124	176	7,65 €
11125	176	8,50 €
11126	176	11,20 €
11127	176	13,80 €
11128	176	14,10 €
11129	176	14,10 €
11130	176	13,10 €
11131	176	14,10 €
11132	176	13,70 €
11133	176	12,00 €
11134	176	15,00 €
11135	176	17,20 €
11136	176	15,30 €
11137	176	18,20 €
11138	176	18,00 €
11139	176	18,80 €
11140	176	20,40 €
11141	176	18,60 €
11142	176	21,30 €
11143	176	26,40 €
11144	176	33,30 €
11145	176	35,30 €
11146	176	37,30 €
11147	176	41,00 €
11148	176	47,00 €
11149	176	45,00 €
11150	176	55,00 €
11151	176	57,00 €
11152	176	57,00 €
11153	172, 176	23,40 €
11154	176	21,70 €
11155	172, 176	24,40 €

REF.	PÁGINA	PRECIO
11156	176	28,90 €
11157	176	26,60 €
11158	172, 176	28,50 €
11159	176	30,30 €
11160	176	27,00 €
11161	176	32,30 €
11162	176	29,10 €
11163	176	32,70 €
11164	176	30,70 €
11165	176	34,60 €
11166	176	30,90 €
11167	176	38,00 €
11168	176	41,00 €
11169	176	39,20 €
11170	176	40,00 €
11171	176	51,00 €
11172	176	48,00 €
11173	176	47,00 €
11174	176	47,00 €
11175	176	49,00 €
11176	176	56,00 €
11177	176	55,00 €
11178	176	53,00 €
11179	176	65,00 €
11180	176	59,00 €
11181	176	65,00 €
11182	176	73,00 €
11183	176	70,00 €
11184	176	87,00 €
11185	176	97,00 €
11186	176	91,00 €
11187	176	98,00 €
11188	176	103,00 €
11189	176	121,00 €
11190	176	138,00 €
11191	176	149,00 €
11192	176	152,00 €
11193	176	183,00 €
11194	176	176,00 €
11195	168, 169, 176	3,70 €
11212	63	5,00 €
11213	63	10,60 €
11214	63	12,50 €
11244	45	8,50 €
11245	45	9,15 €
11246	45	12,40 €
11247	45	14,00 €
11248	45	14,60 €
11249	45	26,50 €
11258	43	7,30 €
11259	43	8,30 €
11260	43	9,75 €
11261	43	11,35 €
11262	43	13,50 €
11314	173	8,50 €
11315	173	8,50 €
11316	173	8,50 €

REF.	PÁGINA	PRECIO
11318	410	2,50 €
11324	139	17,50 €
11325	139	17,50 €
11328	355	4,00 €
11330	412	0,57 €
11360	32	2,60 €
11361	32	3,20 €
11362	32	5,20 €
11363	32	3,90 €
11364	32	4,50 €
11365	32	9,40 €
11374	200	5,50 €
11375	200	6,50 €
11376	200	5,50 €
11377	200	5,50 €
11378	200	6,50 €
11379	200	6,00 €
11380	200	6,50 €
11381	200	6,50 €
11382	200	6,00 €
11383	200	6,00 €
11384	200	6,00 €
11385	200	5,50 €
11386	200	6,00 €
11387	200	6,00 €
11388	200	6,00 €
11389	200	6,00 €
11390	200	6,00 €
11391	200	6,50 €
11392	200	6,00 €
11393	200	6,00 €
11394	200	6,00 €
11434	226	12,00 €
11435	226	12,00 €
11436	226	12,00 €
11437	226	12,00 €
11438	226	12,00 €
11439	226	12,00 €
11440	226	12,00 €
11441	226	12,00 €
11442	226	12,00 €
11443	227	14,00 €
11444	227	14,00 €
11445	227	15,00 €
11446	227	15,00 €
11447	227	15,50 €
11450	226	12,00 €
11541	180	11,00 €
11542	180	11,00 €
11543	180	11,00 €
11544	180	7,00 €
11545	180	11,00 €
11546	180	12,00 €
11547	180	12,00 €
11613	176	11,00 €
11614	176	13,00 €
11615	176	14,20 €

REF.	PÁGINA	PRECIO
11616	176	18,10 €
11617	176	18,70 €
11618	176	18,80 €
11619	176	19,50 €
11621	176	290,00 €
11622	176	399,00 €
11623	176	489,00 €
11624	176	189,00 €
11625	176	282,00 €
11628	173	9,50 €
11639	43	4,00 €
11640	43	4,50 €
11641	43	5,00 €
11642	43	5,00 €
11643	43	6,00 €
11644	43	7,00 €
11645	43	7,00 €
11646	43	9,45 €
11867	308	9,00 €
11878	214	4,10 €
11879	214	5,10 €
11880	214	10,50 €
11890	359	0,55 €
11891	359	0,50 €
11893	211	7,00 €
11894	211	7,00 €
11895	211	8,65 €
11896	211	8,80 €
11897	190, 351	155,00 €
11900	370	3,50 €
11901	370	2,50 €
11902	370	3,50 €
11903	370	5,00 €
11904	370	2,00 €
11905	370	1,50 €
11906	370	8,50 €
11907	370	11,00 €
11936	202	4,00 €
11937	202	5,00 €
11938	174	47,00 €
11945	53	7,00 €
11946	53	4,50 €
11947	53	19,00 €
11956	152	5,50 €
11957	152	5,50 €
11959	189	10,50 €
11960	369, 370	1,50 €
11962	32, 168, 169, 175	7,50 €
11963	175	9,00 €
11964	32, 175	12,50 €
11965	175	16,00 €
11966	175	18,00 €
11967	175	18,00 €
11971	99	3,60 €
11974	339	1,80 €
11975	339	1,80 €
11976	339	1,80 €

REF.	PÁGINA	PRECIO
11977	339	1,80 €
11978	339	1,80 €
11979	339	1,80 €
11980	339	1,80 €
11981	339	1,80 €
11982	339	1,80 €
11983	339	1,80 €
11989	144	2,00 €
11990	168, 169, 174	15,30 €
11994	89	33,00 €
11996	88	48,00 €
11997	88	39,00 €
11998	88	49,00 €
12009	162	11,00 €
12022	188	33,70 €
12029	35	5,50 €
12030	35	6,50 €
12044	305	147,00 €
12055	351	20,00 €
12060	64	2,50 €
12061	169, 170, 176	9,50 €
12062	169, 170, 176	9,50 €
12063	169, 170, 176	9,50 €
12064	169, 176	9,00 €
12065	169, 170, 176	9,00 €
12066	169, 170, 172, 176	9,00 €
12067	169, 176	9,50 €
12068	169, 170, 172, 176	9,50 €
12069	169, 170, 172, 176	9,50 €
12070	169, 170, 176	10,50 €
12071	169, 170, 176	11,00 €
12072	169, 176	12,00 €
12074	169, 174	11,50 €
12075	168, 169, 174	15,50 €
12093	226	12,00 €
12200	219	14,50 €
12901	207	5,20 €
12926	241	21,50 €
12927	241	21,50 €
12928	241	22,00 €
12929	241	23,00 €
12930	241	23,50 €
12931	171	7,50 €
12932	171	7,50 €
12933	171	8,00 €
12934	171	7,50 €
12935	171	8,00 €
12936	171	8,50 €
12937	168, 169, 174	9,50 €
12938	171	10,00 €
12939	171	10,00 €
12940	171	10,00 €
12941	171	10,00 €

REF.	PÁGINA	PRECIO
12942	171	10,00 €
12943	171	10,00 €
12944	171	10,00 €
12945	171	10,50 €
12950	412	3,45 €
12952	412	1,92 €
12954	394	0,25 €
12955	180	27,80 €
12956	180	27,80 €
12957	180	27,80 €
12958	180	27,80 €
12959	180	27,80 €
12960	180	27,80 €
12961	180	27,80 €
12973	370	1,00 €
12974	196	21,00 €
12975	196	23,00 €
12977	221	36,50 €
12984	176	379,00 €
12987	152	1,50 €
12988	166	12,00 €
12995	53	7,00 €
12996	53	7,00 €
12997	53	7,50 €
12998	53	9,00 €
12999	53	9,50 €
13002	396	1,45 €
13003	396	1,70 €
13004	396	1,85 €
13005	396	1,25 €
13006	396	1,40 €
13007	396	1,30 €
13008	396	2,25 €
13009	396	1,65 €
13010	396	1,75 €
13011	396	1,15 €
13012	396	1,80 €
13013	396	1,75 €
13014	396	1,45 €
13015	396	1,20 €
13016	396	1,15 €
13017	396	2,60 €
13018	396	1,45 €
13019	396	1,75 €
13020	396	1,70 €
13021	396	1,30 €
13022	396	2,10 €
13023	396	1,50 €
13024	396	2,45 €
13025	396	1,50 €
13026	400	1,55 €
13027	400	1,85 €
13028	400	1,45 €
13029	400	1,65 €
13030	400	2,80 €
13031	400	1,85 €
13032	400	2,00 €

REF.	PÁGINA	PRECIO
13033	400	1,60 €
13034	400	2,65 €
13035	400	1,65 €
13036	400	1,40 €
13037	400	2,10 €
13038	398	1,40 €
13039	398	1,65 €
13040	398	1,80 €
13041	398	1,55 €
13042	398	1,95 €
13043	398	1,20 €
13044	398	1,55 €
13045	398	1,20 €
13046	398	1,55 €
13047	398	1,45 €
13048	398	2,20 €
13049	398	2,05 €
13050	399	1,55 €
13051	399	1,50 €
13052	399	1,25 €
13053	399	2,80 €
13054	399	2,35 €
13055	399	3,00 €
13056	398	1,55 €
13057	398	1,50 €
13058	398	2,20 €
13059	398	2,35 €
13060	398	1,60 €
13061	398	2,65 €
13062	398	2,35 €
13063	398	1,15 €
13064	398	2,60 €
13065	398	2,00 €
13066	398	2,25 €
13067	398	2,55 €
13068	399	2,85 €
13069	399	4,55 €
13070	399	2,15 €
13071	399	2,05 €
13072	399	2,75 €
13073	399	2,10 €
13074	400	4,65 €
13075	400	5,35 €
13076	400	3,90 €
13077	400	2,55 €
13078	400	2,55 €
13079	400	3,35 €
13080	398	1,75 €
13081	398	2,30 €
13082	398	1,35 €
13083	398	1,50 €
13084	398	2,10 €
13085	398	1,60 €
13086	398	1,25 €
13087	398	3,30 €
13088	398	2,40 €
13089	398	1,70 €

REF.	PÁGINA	PRECIO
13090	398	1,70 €
13091	398	1,25 €
13092	400	1,65 €
13093	400	2,95 €
13094	400	1,50 €
13095	400	1,20 €
13096	400	1,70 €
13097	400	1,20 €
13098	400	1,65 €
13099	400	2,75 €
13100	400	1,20 €
13101	400	1,50 €
13102	400	1,60 €
13103	400	1,80 €
13104	396	1,90 €
13105	396	2,50 €
13106	396	2,00 €
13107	396	2,15 €
13108	396	1,90 €
13109	396	2,90 €
13110	396	1,85 €
13111	396	1,20 €
13112	396	1,65 €
13113	396	2,20 €
13114	396	2,20 €
13115	396	2,50 €
13116	399	5,45 €
13117	399	3,65 €
13118	399	15,90 €
13119	399	5,60 €
13120	399	5,50 €
13121	399	8,75 €
13122	399	1,95 €
13123	399	5,35 €
13124	399	8,20 €
13125	399	5,95 €
13126	399	1,55 €
13127	399	5,60 €
13128	397	1,85 €
13129	397	2,00 €
13130	397	3,75 €
13131	397	3,45 €
13132	397	2,65 €
13133	397	3,45 €
13134	397	3,95 €
13135	397	3,45 €
13136	397	2,60 €
13137	397	2,25 €
13138	397	2,85 €
13139	397	3,85 €
13140	397	2,65 €
13141	397	1,80 €
13142	397	3,10 €
13143	397	1,95 €
13144	397	2,20 €
13145	397	3,85 €
13146	397	4,50 €

REF.	PÁGINA	PRECIO
13147	397	3,10 €
13148	397	3,30 €
13149	397	3,10 €
13150	397	2,25 €
13151	397	5,35 €
13152	397	3,05 €
13153	397	3,10 €
13154	397	3,20 €
13155	397	5,60 €
13156	397	3,30 €
13157	397	3,85 €
13158	397	3,75 €
13159	397	3,20 €
13160	397	5,00 €
13161	397	3,55 €
13162	397	2,60 €
13163	397	2,80 €
13217	412	1,31 €
13226	67	4,50 €
13227	67	4,50 €
13228	67	4,50 €
13229	67	4,50 €
13230	67	4,50 €
13231	67	4,50 €
13232	67	4,50 €
13234	305	224,50 €
13235	384	0,15 €
13236	384	0,15 €
13237	384	0,15 €
13238	384	0,20 €
13239	384	0,20 €
13240	384	0,40 €
13241	384	0,55 €
13447	40	16,50 €
13448	40	17,50 €
13449	40	20,00 €
13450	40	23,00 €
13451	40	28,00 €
13452	40	29,50 €
13453	39	9,00 €
13454	39	9,50 €
13455	39	10,50 €
13456	39	11,50 €
13457	39	12,00 €
13460	39	15,00 €
13462	39	17,00 €
13463	40	5,30 €
13464	40	5,30 €
13465	38, 39, 40	5,55 €
13466	38, 39, 40	5,55 €
13467	38, 39, 40	6,00 €
13468	38, 39, 40	6,25 €
13469	38, 39, 40	6,25 €
13470	38, 39, 40	6,60 €
13471	38, 39, 40	6,90 €
13472	38, 39, 40	7,25 €
13473	38, 39, 40	8,10 €

REF.	PÁGINA	PRECIO
13474	38, 39, 40	8,70 €
13475	38, 39, 40	9,10 €
13476	38, 39, 40	9,60 €
13477	40	9,85 €
13478	40	12,20 €
13479	40	13,10 €
13480	40	15,50 €
13481	40	15,80 €
13482	40	22,10 €
13483	40	25,50 €
13484	40	27,20 €
13491	40	5,30 €
13492	40	5,35 €
13493	40	5,50 €
13494	40	6,00 €
13495	40	6,40 €
13496	40	6,60 €
13497	40	7,50 €
13498	40	8,50 €
13499	162	12,50 €
13500	162	12,90 €
13667	66, 89	17,60 €
13668	88	18,70 €
13674	68, 383	0,50 €
13675	68, 383	0,50 €
13676	68, 383	0,50 €
13677	68, 383	0,50 €
13678	68, 383	0,50 €
13680	174	15,50 €
13681	174	15,50 €
13682	174	15,50 €
13683	174	15,50 €
13684	174	15,50 €
13685	174	15,50 €
13686	174	15,50 €
13687	174	15,50 €
13688	174	15,50 €
13689	174	15,50 €
13704	69	21,00 €
13707	59	14,00 €
13708	59	14,00 €
13709	59	14,00 €
13710	59	14,00 €
13712	59	14,00 €
13717	412	7,65 €
13723	176	18,50 €
13724	176	19,20 €
13725	176	19,20 €
13726	176	19,00 €
13727	176	18,70 €
13728	176	18,50 €
13729	176	22,00 €
13730	176	22,00 €
13731	176	21,60 €
13732	176	23,80 €
13733	176	24,90 €
13734	176	25,70 €

REF.	PÁGINA	PRECIO
13735	176	25,80 €
13736	176	25,90 €
13738	360	3,50 €
13739	360	5,50 €
13740	360	5,50 €
13741	372	21,00 €
13745	176	25,20 €
13746	176	25,40 €
13747	176	25,40 €
13748	176	24,90 €
13805	370	10,50 €
13806	370	10,50 €
13809	166	18,50 €
13810	166	20,50 €
13813	185	7,00 €
13814	185	11,00 €
13817	151	17,00 €
13818	151	20,50 €
13819	388	6,50 €
13820	388	7,00 €
13821	388	14,00 €
13822	388	11,00 €
13823	388	6,00 €
13824	388	8,00 €
13825	388	11,50 €
13826	388	13,00 €
13827	388	15,00 €
13828	388	11,50 €
13829	388	10,50 €
13830	388	10,50 €
13831	388	12,60 €
13832	388	13,00 €
13833	388	9,00 €
13839	144	8,50 €
13842	180	8,50 €
13843	180	7,00 €
13844	180	9,00 €
13845	180	8,00 €
13856	202	7,80 €
13859	172	16,00 €
13874	172	17,50 €
13875	172	18,50 €
13876	172	18,50 €
13877	172	18,50 €
13879	360	1,38 €
13880	360	1,50 €
13923	89	7,45 €
13929	406, 410	3,45 €
13930	165	1,50 €
13931	165	2,50 €
13932	165	2,50 €
13933	165	2,00 €
13934	165	2,50 €
13935	165	2,50 €
13936	165	3,50 €
13937	165	4,00 €
13938	165	3,50 €

REF.	PÁGINA	PRECIO
13939	165	4,00 €
13945	387	7,40 €
13946	387	6,70 €
13947	387	5,85 €
13948	387	5,00 €
13949	387	6,50 €
13950	387	7,80 €
13951	387	5,15 €
13952	387	10,90 €
13953	387	8,00 €
13954	387	12,70 €
13955	387	4,95 €
13956	387	4,30 €
13957	387	9,70 €
13958	387	5,45 €
13959	387	10,10 €
13960	387	9,65 €
13961	387	9,25 €
13962	387	1,76 €
13963	387	12,40 €
13964	387	15,00 €
13965	387	1,50 €
13966	387	12,90 €
13967	387	4,65 €
13968	409	1,35 €
13969	204	19,00 €
13982	303	4,00 €
14004	171	9,50 €
14005	171	10,50 €
14006	171	9,50 €
14007	171	9,50 €
14008	171	9,50 €
14009	171	9,50 €
14010	171	11,00 €
14011	171	11,00 €
14013	152	3,50 €
14026	53	5,50 €
14027	53	5,60 €
14029	53	8,50 €
14030	53	9,50 €
14031	131, 144	7,90 €
14032	144	12,00 €
14033	144	4,50 €
14034	410	9,00 €
14049	237	8,00 €
14050	237	10,50 €
14051	237	18,00 €
14052	237	19,50 €
14075	165	2,00 €
14076	165	1,50 €
14077	165	4,50 €
14078	165	4,00 €
14083	412	13,20 €
14114	89	19,30 €
14118	365	26,00 €
14120	146	22,00 €
14121	146	26,00 €

REF.	PÁGINA	PRECIO
14122	148	34,00 €
14123	148	33,00 €
14124	150	20,50 €
14125	150	19,50 €
14126	153	54,00 €
14127	155	32,50 €
14129	151	12,50 €
14130	151	21,00 €
14131	149	24,00 €
14133	155	16,50 €
14135	155	12,50 €
14136	152	12,00 €
14137	159	131,00 €
14145	328	8,50 €
14146	328	8,00 €
14147	328	25,00 €
14148	328	25,00 €
14153	149	20,50 €
14154	153	42,00 €
14157	161	8,30 €
14158	161	9,95 €
14159	161	12,60 €
14160	161	12,80 €
14161	161	13,70 €
14162	153	25,50 €
14163	153	25,50 €
14164	153	25,50 €
14165	146	26,50 €
14167	70	2,50 €
14168	160	7,00 €
14169	163	3,00 €
14172	173	8,50 €
14173	173	9,50 €
14177	173	9,50 €
14178	173	9,50 €
14179	58	8,50 €
14180	58	7,90 €
14183	68	31,00 €
14187	219	6,00 €
14188	160	0,50 €
14189	412	52,00 €
14190	165	2,00 €
14191	165	2,00 €
14192	165	4,00 €
14193	165	4,00 €
14195	166	4,00 €
14196	166	4,00 €
14197	166	4,50 €
14198	166	4,00 €
14199	166	4,00 €
14200	166	4,50 €
14201	165	4,00 €
14202	165	4,00 €
14203	165	4,50 €
14204	165	1,50 €
14205	165	1,50 €
14206	165	1,50 €

REF.	PÁGINA	PRECIO
14207	165	1,50 €
14208	165	1,50 €
14209	165	1,50 €
14211	237	11,00 €
14212	237	12,00 €
14213	237	12,00 €
14214	237	14,00 €
14286	153	2,99 €
14287	153	2,99 €
14288	153	6,00 €
14289	153	6,10 €
14296	74, 75, 76, 77, 83	118,00 €
14297	74, 75, 76, 77, 83	87,00 €
14298	74, 75, 76, 77, 83	51,50 €
14299	74, 75, 76, 77, 83	87,00 €
14300	220	19,00 €
14301	220	19,00 €
14314	166	5,00 €
14315	166	4,50 €
14330	153	3,50 €
14336	149	58,00 €
14340	237	10,50 €
14341	237	10,50 €
14342	237	10,50 €
14343	237	10,50 €
14344	237	11,00 €
14345	237	11,00 €
14346	237	11,00 €
14347	408	36,50 €
14348	212	12,50 €
14349	212	20,50 €
14350	403, 404	1,80 €
14351	404	1,65 €
14352	404	1,30 €
14353	404	2,10 €
14354	90	14,00 €
14355	404	1,70 €
14356	404	1,90 €
14357	404	1,90 €
14358	403, 404	1,70 €
14359	401, 404	1,05 €
14361	404	1,70 €
14364	404	1,90 €
14365	404	1,90 €
14366	404	1,45 €
14367	404	1,30 €
14368	404	1,45 €
14369	404	4,95 €
14370	404	3,00 €
14371	404	3,00 €
14372	404	1,20 €
14373	404	1,35 €
14374	403	1,70 €
14375	403	1,85 €
14376	403	2,60 €
14377	403	1,90 €

REF.	PÁGINA	PRECIO
14378	403	1,90 €
14379	403	1,45 €
14380	411	51,00 €
14381	403	1,70 €
14382	403	1,85 €
14383	403	1,35 €
14384	403	2,10 €
14387	403	1,45 €
14388	403	2,05 €
14389	403	1,25 €
14390	403	1,35 €
14391	403	2,15 €
14392	403	1,35 €
14393	403	1,50 €
14395	403	1,65 €
14396	403	1,20 €
14397	403	1,45 €
14398	403	1,30 €
14399	403	1,90 €
14402	403	1,50 €
14404	403	2,10 €
14405	403	1,45 €
14406	403	1,55 €
14408	403	1,45 €
14409	403	1,35 €
14410	402	1,85 €
14411	402	1,70 €
14412	402	1,70 €
14413	402	3,25 €
14414	402	1,70 €
14415	402	1,70 €
14416	402, 403	1,25 €
14419	402	1,95 €
14420	402	1,50 €
14421	402	2,45 €
14422	401, 402	1,50 €
14423	402	3,55 €
14424	402	1,85 €
14425	402	2,05 €
14426	402	1,90 €
14427	402	1,20 €
14428	402	1,40 €
14429	402	1,80 €
14430	402	2,25 €
14431	402	1,45 €
14432	402	1,45 €
14434	402	1,60 €
14435	402	1,45 €
14436	402	1,70 €
14437	402	1,45 €
14438	402	1,35 €
14439	402	1,75 €
14440	402	1,75 €
14441	402	1,65 €
14442	402	1,45 €
14443	402	1,45 €
14444	402	1,90 €

REF.	PÁGINA	PRECIO
14445	402	1,45 €
14446	401	2,80 €
14447	401	1,45 €
14448	401	2,05 €
14449	401	2,20 €
14450	401	2,15 €
14451	401	2,15 €
14452	401	2,55 €
14453	401	3,05 €
14455	401	2,10 €
14456	401	1,35 €
14457	401	1,70 €
14458	401	1,70 €
14459	401	1,45 €
14460	401	1,15 €
14461	401	1,35 €
14462	401	1,65 €
14463	401	1,65 €
14464	401	1,50 €
14465	401	2,00 €
14466	401	1,65 €
14468	401	1,30 €
14469	401	1,45 €
14471	401	1,90 €
14472	401	1,35 €
14474	401	1,50 €
14475	401	1,65 €
14476	401	2,05 €
14477	401	2,45 €
14478	401	4,05 €
14479	401	1,65 €
14480	401	2,05 €
14481	401	1,70 €
14507	412	50,00 €
14534	161	16,50 €
14560	161	8,80 €
14561	166	8,80 €
14563	214	18,00 €
14564	183	9,20 €
14565	183	26,70 €
14566	183	16,70 €
14567	183	38,00 €
14568	183	9,20 €
14569	183	9,20 €
14570	183	4,05 €
14571	183	9,20 €
14573	183	4,05 €
14578	92	12,50 €
14580	92	41,00 €
14583	148	6,00 €
14594	221, 389	2,00 €
14595	221, 389	1,50 €
14596	221, 389	2,00 €
14597	221, 389	7,60 €
14598	221, 389	17,80 €
14599	221, 389	4,50 €
14600	221, 389	9,50 €

REF.	PÁGINA	PRECIO
14601	221, 389	11,00 €
14602	221, 389	11,00 €
14611	240	12,00 €
14612	240	11,00 €
14613	240	13,50 €
14616	321	96,00 €
14618	147	19,00 €
14622	123, 410	17,00 €
14623	123, 410	8,00 €
14624	123, 410	17,00 €
14625	123, 410	14,00 €
14626	123, 410	7,00 €
14633	147	22,50 €
14710	183	3,50 €
14711	183	3,75 €
14712	183	4,00 €
14713	183	4,25 €
14714	183	4,50 €
14715	183	4,75 €
14723	172	18,00 €
14724	172	18,50 €
14725	172	18,50 €
14726	172	17,50 €
14728	168, 169, 176	3,80 €
14729	168, 169, 176	3,80 €
14730	168, 169, 176	3,80 €
14731	168, 169, 176	3,80 €
14732	168, 169, 176	3,80 €
14733	168, 169, 176	4,30 €
14734	168, 169, 176	5,40 €
14735	169	6,50 €
14736	170, 176	5,00 €
14737	170, 176	5,00 €
14738	170, 176	5,50 €
14739	170, 176	5,50 €
14740	170, 176	5,55 €
14741	170, 176	5,55 €
14742	170, 176	5,55 €
14743	170, 176	5,15 €
14744	170, 176	5,35 €
14745	170, 176	6,25 €
14746	170, 176	6,40 €
14747	170, 176	7,10 €
14748	170, 176	8,30 €
14749	32, 175	2,00 €
14750	32, 175	2,00 €
14751	32, 175	4,00 €
14752	32, 175	4,00 €
14753	143	13,00 €
14771	164, 338	10,50 €
14772	164	8,50 €
14774	338	10,50 €
14775	380	30,50 €
14779	150	33,00 €
14781	377	990 €

REF.	PÁGINA	PRECIO
14783	92	5,50 €
14793	378	12,00 €
14803	380	43,00 €
14807	412	11,00 €
14825	123	1,50 €
14826	123	1,50 €
14827	123	2,00 €
14828	123	1,50 €
14829	123	1,50 €
14830	123	1,50 €
14831	123	1,50 €
14832	123	2,00 €
14833	123	2,05 €
14834	123	2,50 €
14835	123	3,00 €
14836	123	3,50 €
14837	123	3,30 €
14838	123	3,40 €
14839	123	4,70 €
14840	123	3,35 €
14841	124	2,58 €
14842	124	9,50 €
14843	125	0,50 €
14844	125	0,50 €
14845	125	0,50 €
14846	125	0,50 €
14847	125	0,50 €
14848	125	0,50 €
14849	125	1,00 €
14850	125	1,00 €
14851	125	1,00 €
14852	125	1,00 €
14853	125	1,00 €
14854	125	1,00 €
14855	125	1,00 €
14856	125	1,00 €
14857	125	1,50 €
14858	125	1,50 €
14859	125	1,50 €
14860	125	2,00 €
14861	125	2,00 €
14862	125	2,00 €
14863	125	2,50 €
14864	125	2,50 €
14865	125	2,50 €
14866	125	3,00 €
14867	125	3,00 €
14868	125	0,55 €
14869	125	0,60 €
14870	125	1,00 €
14871	125	1,00 €
14872	125	1,00 €
14873	125	1,00 €
14874	125	1,00 €
14875	125	1,50 €
14876	125	1,50 €
14877	125	1,50 €

REF.	PÁGINA	PRECIO
14878	125	2,00 €
14879	125	2,00 €
14880	125	2,50 €
14881	125	2,50 €
14882	125	3,00 €
14883	125	3,50 €
14884	125	3,65 €
14885	125	4,00 €
14886	125	4,60 €
14887	125	5,00 €
14888	125	6,00 €
14889	125	6,50 €
14890	125	7,00 €
14891	125	7,50 €
14892	125	8,00 €
14893	128	2,00 €
14894	128	1,20 €
14895	128	1,90 €
14896	128	2,10 €
14897	128	0,88 €
14898	128	0,98 €
14899	128	0,88 €
14900	128	0,98 €
14901	124	3,60 €
14902	124	4,65 €
14903	124	5,25 €
14904	124	6,85 €
14905	124	8,50 €
14906	124	10,20 €
14907	124	0,50 €
14908	124	0,60 €
14909	124	0,80 €
14910	124	1,00 €
14911	124	1,30 €
14912	124	1,55 €
14913	124	1,90 €
14914	124	2,10 €
14915	124	2,65 €
14916	124	2,95 €
14917	124	3,45 €
14920	123	2,50 €
14922	412	0,84 €
14923	412	0,84 €
14924	412	0,84 €
14925	412	0,84 €
14926	412	1,05 €
14930	204	9,50 €
14931	204	8,00 €
14932	204	9,50 €
14933	204	9,50 €
14934	124	4,25 €
14935	124	8,45 €
14945	411	303,50 €
14946	411	58,00 €
14947	411	201,50 €
14948	411	251,50 €
14950	116	6,50 €

REF.	PÁGINA	PRECIO
14951	116	9,50 €
14952	116	19,00 €
14953	116	8,50 €
14970	168	2,50 €
14971	168	2,50 €
14972	168	3,50 €
14973	168, 169	11,50 €
14974	412	2,28 €
14975	410	64,00 €
14976	412	18,84 €
14978	53	7,50 €
14979	53	9,00 €
14980	53	13,00 €
14981	53	22,50 €
14982	53	27,50 €
14985	128	6,00 €
14986	128	4,00 €
14987	128	8,50 €
14988	128	8,00 €
14989	128	6,00 €
14990	128	10,50 €
14991	128	2,00 €
14992	200	8,50 €
14993	128	5,00 €
14994	128	3,50 €
14995	128	8,00 €
14996	411	65,00 €
15010	97	16,50 €
15011	97	18,00 €
15012	97	31,50 €
15014	127	20,00 €
15023	92	12,50 €
15024	92	15,00 €
15025	92	12,50 €
15026	92	15,00 €
15030	92	8,00 €
15033	92	6,00 €
15034	92	57,00 €
15035	92	8,50 €
15036	92	8,50 €
15037	92	8,00 €
15038	92	34,50 €
15040	92	12,50 €
15041	92	15,00 €
15042	92	7,50 €
15049	117	37,40 €
15050	92	9,50 €
15051	412	1,92 €
15052	219	3,00 €
15053	219	10,50 €
15054	219	34,00 €
15056	412	11,70 €
15058	92	7,50 €
15059	378	10,00 €
15062	378	1,00 €
15065	92	6,50 €
15068	90	15,20 €

REF.	PÁGINA	PRECIO
15069	90	32,80 €
15070	82	0,50 €
15071	82	0,60 €
15072	82	0,70 €
15073	82	1,00 €
15074	82	1,00 €
15075	82	1,20 €
15076	82	3,50 €
15083	88	8,50 €
15084	88, 203, 307	68,00 €
15093	317	38,00 €
15094	317	39,50 €
15095	317	13,00 €
15096	317	40,00 €
15122	39, 75, 85	74,00 €
15138	51	10,50 €
15139	51	12,00 €
15140	51	13,50 €
15144	93	30,00 €
15145	94	20,45 €
15146	94	16,20 €
15147	50	5,00 €
15148	50	5,00 €
15149	50	5,00 €
15152	408	160,00 €
15155	75, 85	59,00 €
15156	43, 85	70,00 €
15157	85	42,00 €
15158	85	59,00 €
15159	85	44,00 €
15160	85	42,00 €
15161	75, 85	62,00 €
15162	36, 87, 345	30,20 €
15206	43	15,00 €
15207	43	16,50 €
15208	43	17,00 €
15209	43	18,00 €
15227	36	3,50 €
15228	36	4,00 €
15229	36	5,00 €
15230	36	5,00 €
15231	36	3,50 €
15232	36	4,00 €
15233	36	5,00 €
15234	36	3,00 €
15253	222, 225	62,00 €
15300	369	5,00 €
15313	90	14,00 €
15315	86	28,20 €
15316	39, 86	58,00 €
15317	369	4,50 €
15328	39	6,00 €
15329	39	5,50 €
15330	39	5,50 €
15331	39	5,50 €
15332	39	6,00 €
15333	39	6,50 €

REF.	PÁGINA	PRECIO
15334	39	7,00 €
15335	39	7,50 €
15336	39	8,00 €
15337	39	8,50 €
15338	39	9,00 €
15339	39	9,50 €
15375	183	28,00 €
15385	135	18,00 €
15448	343	5,50 €
15454	57, 86	35,40 €
15460	343	5,00 €
15494	200	12,50 €
15495	200	12,50 €
15496	200	11,50 €
15497	200	11,00 €
15498	200	11,50 €
15499	200	11,00 €
15500	200	10,00 €
15501	200	10,00 €
15502	200	10,00 €
15503	200	11,00 €
15504	200	10,00 €
15505	200	4,00 €
15506	200	4,00 €
15507	200	4,50 €
15508	200	4,50 €
15509	200	5,00 €
15510	200	5,00 €
15511	200	8,00 €
15514	75, 86	9,35 €
15515	39	15,50 €
15516	39	19,00 €
15517	39	22,50 €
15541	86	27,60 €
15552	190, 351	181,00 €
15564	148	11,90 €
15619	355	4,00 €
15631	303	98,00 €
15632	38	9,00 €
15633	38	9,50 €
15634	38	11,00 €
15635	38	12,50 €
15636	38	14,00 €
15637	38	15,00 €
15681	85	134,00 €
15706	63, 86	31,00 €
15730	78, 84	289,00 €
15731	78, 84	214,00 €
15732	78, 84	293,50 €
15733	78, 84	113,00 €
15734	78, 84	288,50 €
15735	78, 84	152,00 €
15736	78, 84	488,50 €
15737	66, 86	45,00 €
15783	65	3,50 €
15784	65	3,50 €
15785	65	3,50 €

REF.	PÁGINA	PRECIO
15786	65	3,50 €
15787	65	3,50 €
15799	63, 87	28,30 €
15866	350	32,00 €
15874	310	6,50 €
16010	46	4,00 €
16011	46	4,00 €
16012	46	4,00 €
16013	46	4,50 €
16014	46	4,50 €
16015	46	5,00 €
16016	46	5,00 €
16017	46	5,00 €
16018	46	5,50 €
16019	46	6,00 €
16020	41	17,00 €
16021	41	19,50 €
16022	41	23,00 €
16023	41	26,50 €
16024	41	34,50 €
16025	41	37,50 €
16052	137, 144	2,09 €
16053	137, 144	2,85 €
16111	61, 87	19,20 €
16130	343	290,00 €
16161	91	17,50 €
16162	91	35,10 €
16163	91	10,20 €
16188	91	39,60 €
16198	343	5,00 €
16237	237	23,00 €
16238	237	23,00 €
16239	237	23,00 €
16240	237	26,00 €
16241	237	23,00 €
16242	237	26,00 €
16243	237	23,00 €
16273	150	12,50 €
16294	395	14,00 €
16295	206	30,00 €
16300	227	7,60 €
16301	227	7,60 €
16302	227	7,60 €
16304	172	31,00 €
16305	172	31,00 €
16309	220	149,00 €
16316	221	18,50 €
16318	126	0,50 €
16319	126	0,50 €
16320	126	0,50 €
16321	126	1,00 €
16322	126	1,00 €
16323	126	1,00 €
16324	126	1,50 €
16325	126	1,50 €
16326	126	2,00 €
16327	126	2,00 €

REF.	PÁGINA	PRECIO
16328	126	2,50 €
16329	126	3,00 €
16330	126	3,50 €
16331	126	3,50 €
16332	126	4,00 €
16333	126	4,50 €
16334	126	5,50 €
16335	126	6,00 €
16336	126	6,50 €
16341	147	32,50 €
16342	65	2,50 €
16343	65	2,50 €
16344	90	43,00 €
16354	90	1,50 €
16355	90	2,00 €
16356	90	2,50 €
16357	90	2,50 €
16358	90	12,00 €
16359	90	10,00 €
16360	90	12,00 €
16361	90	16,50 €
16362	90	20,00 €
16363	90	14,50 €
16364	123, 410	3,50 €
16366	206	11,00 €
16367	206	10,00 €
16368	206	12,00 €
16369	206	12,00 €
16370	206	12,00 €
16371	206	11,00 €
16372	206	11,50 €
16373	206	12,00 €
16374	206	12,00 €
16375	206	15,00 €
16376	206	15,00 €
16377	206	16,00 €
16378	206	15,00 €
16379	206	15,00 €
16380	206	16,00 €
16381	206	10,00 €
16382	206	10,00 €
16383	206	15,00 €
16384	206	15,00 €
16385	242	10,00 €
16386	242	11,50 €
16387	92	10,50 €
16388	242	11,50 €
16389	242	11,50 €
16391	39	4,60 €
16392	39	4,60 €
16393	39	4,60 €
16394	39	5,10 €
16395	39	5,10 €
16396	39	5,10 €
16397	39	5,50 €
16398	39	5,50 €
16399	39	5,50 €

REF.	PÁGINA	PRECIO
16400	259	6,50 €
16401	39	6,10 €
16402	39	6,10 €
16403	39	6,10 €
16430	233	20,50 €
16431	233	20,50 €
16432	233	20,50 €
16433	233	20,50 €
16434	233	20,50 €
16435	233	21,50 €
16436	233	21,50 €
16448	222	16,50 €
16462	389	36,50 €
16463	389	36,50 €
16464	389	36,50 €
16465	389	39,50 €
16466	389	50,00 €
16467	389	36,50 €
16468	389	36,50 €
16469	389	36,50 €
16470	389	39,50 €
16471	389	50,00 €
16472	389	17,50 €
16473	389	17,50 €
16474	389	17,50 €
16475	389	17,50 €
16476	389	24,00 €
16477	389	24,50 €
16478	389	24,50 €
16479	389	7,50 €
16480	389	7,50 €
16481	93	14,00 €
16482	93	13,50 €
16490	73	650,00 €
16491	73	307,00 €
16492	73	675,00 €
16493	73	436,00 €
16494	73	139,00 €
16496	73	127,00 €
16497	73	77,00 €
16498	73	84,00 €
16499	73	162,00 €
16500	73	463,00 €
16516	73	121,00 €
16538	389	19,50 €
16539	389	18,00 €
16540	389	13,00 €
16541	389	13,00 €
16542	389	23,50 €
16543	389	13,00 €
16546	43	5,00 €
16547	43	5,50 €
16548	43	9,00 €
16549	43	14,00 €
16561	73	36,50 €
16564	147	17,00 €
16565	233	19,50 €

REF.	PÁGINA	PRECIO
16566	233	22,50 €
16571	172	32,00 €
16572	172	33,50 €
16574	172	34,00 €
16575	172	34,50 €
16576	172	35,50 €
16577	172	36,00 €
16583	126	8,50 €
16584	126	10,50 €
16585	126	11,50 €
16586	126	13,00 €
16587	126	14,00 €
16588	126	15,00 €
16600	73	252,00 €
16627	73	225,00 €
16628	73	382,00 €
16629	73	419,00 €
16642	65	1,00 €
16737	226	12,00 €
50400	191	168,00 €
50403	191	98,00 €
50409	192	26,00 €
50410	191	168,00 €
50431	357	3,80 €
50517	350	129,00 €
50518	350	169,00 €
50523	357	4,70 €
50524	357	4,70 €
50525	365	1,00 €
50526	365	4,80 €
50551	357	350,00 €
50562	44	23,50 €
50564	42	30,00 €
50567	57	9,60 €
50577	186	12,60 €
50585	361	14,70 €
50600	368	0,60 €
50601	368	0,29 €
50622	46	64,00 €
50623	21	60,00 €
50630	324	590,00 €
50631	322	68,00 €
50632	335	298,00 €
50644	359	11,60 €
50651	391	18,00 €
50652	391	16,50 €
50654	354	4,00 €
50656	190, 351	290,00 €
50717	359	21,90 €
50724	69	28,00 €
50731	217	68,00 €
50751	156, 312	43,00 €
50760	368	0,10 €
50761	368	0,19 €
50762	368	0,29 €
50763	368	0,38 €
50764	368	0,49 €

REF.	PÁGINA	PRECIO
50765	368	0,58 €
50766	368	0,68 €
50767	368	0,78 €
50768	368	0,88 €
50778	368	0,10 €
50779	368	0,19 €
50780	368	0,29 €
50781	368	0,38 €
50782	368	0,49 €
50783	368	0,58 €
50784	368	0,68 €
50785	368	0,78 €
50786	368	0,88 €
50787	98	8,00 €
50788	98	14,50 €
50789	98	29,00 €
50792	236	105,00 €
50793	236	94,00 €
50797	349	490,00 €
50807	221, 391	38,00 €
50808	99	77,00 €
50815	314	88,00 €
50816	315	88,00 €
50818	314	198,00 €
50819	316	28,00 €
50820	316	34,50 €
50821	316	47,00 €
50822	316	59,00 €
50823	316	94,00 €
50824	316	88,00 €
50825	316	154,00 €
50827	223, 321	387,00 €
50830	317	560,00 €
50831	322	460,00 €
50835	319	290,00 €
50836	323	148,00 €
50838	323	299,00 €
50839	320	180,00 €
50840	322	138,00 €
50843	99	79,00 €
50844	99	65,00 €
50852	312	24,50 €
50901	181	16,00 €
50902	54	13,00 €
50903	181	30,80 €
50910	142	45,00 €
50911	324	788,00 €
50913	190, 351	195,00 €
50915	357	4,20 €
50916	192	0,88 €
50917	305	271,00 €
50918	304	341,00 €
50923	188, 320	454,00 €
50924	308, 351	342,00 €
50935	304	595,00 €
50937	69	10,50 €
50942	331, 344	28,00 €

REF.	PÁGINA	PRECIO
50957	95	22,00 €
50959	95, 386	14,00 €
50966	354	4,00 €
50966C	354	3,00 €
50980	34	22,00 €
50982	34	22,00 €
50983	30	48,00 €
50985	30	59,00 €
51017	56	6,80 €
51018	56	7,05 €
51020	56	6,65 €
51021	56	7,05 €
51028	172	163,00 €
51033	339	98,00 €
51035	94	799,00 €
51050	95	285,00 €
51051	95	34,80 €
51055	368	0,98 €
51059	195	99,00 €
51119	229	62,00 €
51120	213	41,00 €
51121	222	27,30 €
51123	229	91,00 €
51124	241	88,00 €
51125	238	88,00 €
51126	234	18,00 €
51127	52	56,00 €
51127R	52	14,00 €
51131	180	61,00 €
51140	240	64,00 €
51206	146	228,00 €
51207	146	289,00 €
51210	148	650,00 €
51211	148	560,00 €
51212	148	488,00 €
51213	148	690,00 €
51214	150	148,00 €
51215	150	119,00 €
51216	153	650,00 €
51218	155	288,00 €
51220	151	240,00 €
51221	151	199,00 €
51222	149	128,00 €
51226	155	233,00 €
51235	329	49,00 €
51238	328	138,00 €
51239	328	159,00 €
51245	155	99,00 €
51246	358	6,40 €
51253	305	41,00 €
51258	134	0,15 €
51259	231	58,00 €
51260	29	37,00 €
51262	52	51,00 €
51262R	52	14,00 €
51266	359	28,00 €
51272	62	7,50 €

REF.	PÁGINA	PRECIO
51277	157	64,00 €
51283	196	78,00 €
51305	50	28,90 €
51306	50	28,10 €
51307	50	29,70 €
51315	410	2,50 €
51318	38	98,00 €
51326	134	4,40 €
51332	200	98,00 €
51333	32	18,00 €
51336	173	29,30 €
51337	204	50,00 €
51338	52	53,00 €
51338R	52	14,00 €
51340	296	39,30 €
51341	163	35,00 €
51347	230	9,90 €
51349	242	37,30 €
51352	201	9,80 €
51353	201	11,50 €
51354	202	13,20 €
51355	60, 369	19,00 €
51356	308	48,00 €
51358	371	7,50 €
51359	371	9,00 €
51360	181	8,05 €
51361	181	9,80 €
51362	371	3,00 €
51363	328	114,00 €
51364	221	26,00 €
51365	328	118,00 €
51368	224	19,00 €
51369	224	28,00 €
51383	157	11,10 €
51385	162	4,55 €
51386	162	5,95 €
51387	162	3,25 €
51388	153	22,00 €
51389	153	22,00 €
51390	153	22,00 €
51391	153	22,00 €
51392	153	34,00 €
51393	153	34,00 €
51398N	375	1,54 €
51400	204	17,00 €
51401	204	22,00 €
51402	204	20,50 €
51403	204	17,50 €
51405	50	21,10 €
51406	50	29,20 €
51409	33	36,00 €
51410	33	36,00 €
51412	364	2,10 €
51414	224	14,00 €
51416	47	12,00 €
51419	91	2,79 €
51422	91	2,97 €

REF.	PÁGINA	PRECIO
51439	153	26,00 €
51440	153	28,00 €
51441	153	26,00 €
51442	153	28,00 €
51443	162	5,50 €
51444	162	5,05 €
51445	162	5,05 €
51447	53, 87	16,00 €
51448	53, 87	52,00 €
51452	322	69,00 €
51479	53	31,80 €
51488	273	16,00 €
51489	284	12,00 €
51490	225	36,00 €
51491	230	154,00 €
51493	207	68,00 €
51494	205	107,00 €
51495	232	59,00 €
51496	236	8,00 €
51500	240	29,00 €
51501	233	38,00 €
51504	63	8,50 €
51525	62	9,80 €
51526	62	9,80 €
51528	44	49,00 €
51538	388	0,15 €
51539	388	0,15 €
51540	388	0,15 €
51541	388	0,25 €
51542	388	0,20 €
51543	388	0,25 €
51544	388	0,25 €
51545	388	0,30 €
51546	389	0,19 €
51554	389	0,28 €
51573	134	2,50 €
51574	95	52,00 €
51575	96	317,00 €
51576	93	125,00 €
51600	96	109,00 €
51604	368	0,98 €
51612	357	5,95 €
51613	357	2,90 €
51614	357	3,60 €
51615	357	5,95 €
51616	23	378,00 €
51622	192	25,30 €
51632N	375	1,54 €
51633	375	1,54 €
51634	375	1,54 €
51636N	375	1,54 €
51638N	375	1,54 €
51640N	375	1,54 €
51642N	375	1,54 €
51653	91	5,10 €
51654	91	4,80 €
51655	91	4,10 €

REF.	PÁGINA	PRECIO
51656	91	3,65 €
51657	91	5,85 €
51658	91	4,50 €
51659	46	59,00 €
51661	47	12,00 €
51674	63	7,75 €
51692	355	3,55 €
51693	355	3,55 €
51694	355	3,55 €
51696	355	3,55 €
51697	364	0,80 €
51703	359	10,50 €
51705	359	8,45 €
51706	366	22,80 €
51707	366	9,05 €
51708	366	14,20 €
51709	366	14,70 €
51710	366	17,80 €
51711	366	21,20 €
51712	366	8,65 €
51713	366	13,10 €
51714	366	15,80 €
51715	366	20,30 €
51716	366	23,60 €
51717	366	11,20 €
51718	366	14,80 €
51719	366	22,00 €
51720	366	23,50 €
51721	366	25,00 €
51722	366	13,10 €
51723	366	18,70 €
51724	366	24,40 €
51725	366	28,30 €
51726	366	31,40 €
51727	366	49,00 €
51737	94	699,00 €
51738	93	850,00 €
51741	370	0,50 €
51742	370	0,50 €
51743	370	0,55 €
51745	376	0,70 €
51746	34	12,00 €
51751	320	99,00 €
51785	376	1,00 €
51795	47	9,00 €
51796	47	14,00 €
51797	47	18,00 €
51798	47	39,60 €
51799	389	0,20 €
51801	51	62,00 €
51804	386	58,00 €
51805	53, 87	17,00 €
51812	56	46,00 €
51814	369	8,00 €
51816	329	58,00 €
51817	354	4,50 €
51818	18	109,00 €

REF.	PÁGINA	PRECIO
51824	192	36,80 €
51830	52	94,00 €
51831	339	24,00 €
51832	181	18,00 €
51837	336	195,00 €
51838	336	667,00 €
51839	198	24,00 €
51842	330	6,90 €
51843	389	0,19 €
51853	70	18,00 €
51855	23	378,00 €
51858	364	15,00 €
51859	339	3,80 €
51861	159, 359	199,00 €
51863	366	54,00 €
51864	45, 87	64,00 €
51886	142	44,00 €
51889	130	49,00 €
51890	46	92,00 €
51895	315	99,00 €
51896	235	82,00 €
51897	235	122,00 €
51898	235	139,00 €
51899	235	137,00 €
51901	319	999,00 €
51902	229	84,00 €
51905	316	34,50 €
51906	316	39,00 €
51907	316	48,00 €
51908	368	44,00 €
51909	65	2,46 €
51918	63	12,50 €
51919	228	89,00 €
51920	234, 392	18,00 €
51923	201	12,50 €
51925	365	1,00 €
51927	296	25,00 €
51928	308	14,00 €
51929	143	22,00 €
51934	201	11,50 €
51935	354	135,00 €
51936	354	135,00 €
51937	354	135,00 €
51951	70	15,60 €
51958	228	422,00 €
51960	138	34,00 €
51961	138	34,00 €
51962	138	25,00 €
51963	138	29,00 €
51964	138	28,00 €
51965	138	29,50 €
51966	139	18,00 €
51967	144	16,00 €
51968	144	16,00 €
51969	139	14,00 €
51972	60	12,00 €
51973	366	45,00 €

REF.	PÁGINA	PRECIO
51975	91	2,27 €
51976	91	1,63 €
51978	191	84,00 €
51980	156	15,00 €
51981	157	21,50 €
51982	349	120,00 €
51983	349	185,00 €
51984	349	190,00 €
51985	191	84,00 €
51986	234	11,90 €
51989	216	49,00 €
51991	230	54,00 €
51995	58, 59	24,50 €
51998	226	38,00 €
52010	239	80,00 €
52012	228	68,00 €
52016	235	2,10 €
52017	235	2,40 €
52018	235	2,60 €
52019	235	3,20 €
52021	235	3,40 €
52022	235	4,50 €
52023	235	6,60 €
52024	235	10,60 €
52025	235	13,00 €
52026	181	31,80 €
52027	382	14,00 €
52028	385	15,20 €
52029	385	14,00 €
52030	388	98,00 €
52031	387	44,00 €
52032	386	28,00 €
52033	390	43,00 €
52043	384	16,50 €
52044	382	19,00 €
52047	357	3,30 €
52048	357	3,95 €
52049	66	14,00 €
52050	59	98,00 €
52052	57	53,00 €
52053	394	45,00 €
52054	394	17,00 €
52055	322	139,00 €
52056	242	66,00 €
52057	191	6,80 €
52058	191	4,50 €
52059	35	29,00 €
52060	35	32,00 €
52065	191	45,00 €
52066	218	12,00 €
52069	328	29,50 €
52070	328	40,00 €
52071	328	47,00 €
52076	211	111,00 €
52077	183	29,50 €
52148	99	65,00 €
52149	349	230,00 €

REF.	PÁGINA	PRECIO
52152	60	13,50 €
52153	227	46,00 €
52156	149	140,00 €
52157	155	48,00 €
52158	386	38,50 €
52159	151	64,00 €
52160	151	48,00 €
52162	79, 338, 346	38,00 €
52163	388	95,00 €
52165	149	118,00 €
52167	150	48,00 €
52169	55	25,00 €
52170	55	16,00 €
52171	155	39,00 €
52180	63	19,00 €
52181	63	22,50 €
52182	63	24,00 €
52183	63	26,20 €
52184	63	43,00 €
52185	63	55,00 €
52186	63	72,00 €
52187	364	21,80 €
52188	63	15,50 €
52190	216	8,00 €
52191	197	198,00 €
52195	334	170,00 €
52197	50	36,30 €
52198	32	37,70 €
52200	351	88,00 €
52202	351	88,00 €
52207	50	24,20 €
52227	223	247,00 €
52230	190, 350	398,00 €
52231	330	49,00 €
52233	330	328,00 €
52235	48	11,00 €
52236	48	13,30 €
52237	48	18,10 €
52238	48	24,90 €
52241	319	1.690,00 €
52242	311	12,00 €
52243	311	8,50 €
52244	191	84,00 €
52251	364	21,80 €
52254	135	64,00 €
52259	359	3,75 €
52262	185	7,50 €
52263	185	13,50 €
52264	185	18,60 €
52265	185	30,50 €
52269	202	7,00 €
52270	224	109,00 €
52271	283	18,00 €
52272	57	24,60 €
52273	212	44,00 €
52275	198	38,00 €
52293	231	98,00 €

REF.	PÁGINA	PRECIO
52295	185	6,50 €
52296	239	119,00 €
52297	239	172,00 €
52298	239	177,00 €
52302	140	25,40 €
52303	140	26,40 €
52304	316	84,00 €
52305	205	106,00 €
52308	100	440,00 €
52309	100	941,00 €
52310	375	3,65 €
52311	201	19,00 €
52312	201	9,00 €
52313	201	8,00 €
52314	201	26,60 €
52315	198	16,00 €
52316	232	18,90 €
52317	232	19,90 €
52318	69	73,00 €
52319	232	8,80 €
52320	34	22,00 €
52321	186	8,80 €
52327	186	12,00 €
52328	197	99,00 €
52329	303	36,40 €
52330	194	99,00 €
52331	159	201,00 €
52337	168	65,00 €
52338	173	41,00 €
52339	171	61,00 €
52340	171	58,00 €
52341	169	58,00 €
52342	170	63,00 €
52343	173	52,00 €
52344	171	197,00 €
52345	168	109,00 €
52346	169	103,00 €
52347	171	158,00 €
52348	172	179,00 €
52349	48	22,10 €
52350	48	22,60 €
52351	48	25,40 €
52352	48	32,40 €
52353	48	33,40 €
52354	48	34,40 €
52355	48	36,60 €
52357	48	54,00 €
52358	48	63,00 €
52362	357	1,23 €
52363	357	1,23 €
52364	357	2,86 €
52365	357	2,46 €
52368	357	1,14 €
52369	357	1,19 €
52370	357	1,17 €
52373	93	252,00 €
52375	137	38,00 €

REF.	PÁGINA	PRECIO
52378	163	10,00 €
52381	157	20,50 €
52382	331, 344	19,50 €
52384	132	29,00 €
52385	186	251,00 €
52386	186	23,60 €
52390	187	35,20 €
52391	311	5,00 €
52412	59	5,00 €
52414	141	19,00 €
52415	141	19,00 €
52416	203	14,00 €
52417	203	28,00 €
52418	21	179,00 €
52419	89	80,00 €
52420	89	108,00 €
52421	89	172,00 €
52422	213	24,70 €
52424	47	64,00 €
52425	63	33,30 €
52426	63	52,00 €
52427	63	64,00 €
52428	305	40,00 €
52430	376	10,90 €
52432	224	35,00 €
52433	69	4,80 €
52434	197	125,00 €
52439	331	227,00 €
52450	338	105,00 €
52451	43	42,00 €
52452	310	8,00 €
52453	310	21,00 €
52454	238	12,90 €
52455	198	16,00 €
52456	137	36,00 €
52460	63	16,60 €
52461	63	25,70 €
52462	68	25,30 €
52463	67	26,10 €
52464	67	42,00 €
52466	98	11,00 €
52468	62	5,90 €
52472	62	4,90 €
52473	62	9,90 €
52474	187	68,00 €
52475	187	62,00 €
52476	187	50,00 €
52477	187	70,00 €
52478	187	49,00 €
52479	187	24,70 €
52480	187	44,00 €
52481	187	52,00 €
52482	187	44,00 €
52483	187	41,00 €
52484	187	66,00 €
52485	187	51,00 €
52486	187	62,00 €

REF.	PÁGINA	PRECIO
52487	187	63,00 €
52488	211	28,00 €
52489	210	58,00 €
52490	156	6,65 €
52491	156	10,50 €
52493	378	4,50 €
52494	241	227,00 €
52495	216	14,50 €
52497	192	26,80 €
52498	308	58,00 €
52500	54	19,00 €
52502	187	31,40 €
52503	187	32,50 €
52504	187	27,60 €
52505	187	20,80 €
52506	187	16,00 €
52507	187	30,10 €
52508	59	38,40 €
52509	59	36,20 €
52511	187	42,00 €
52512	187	50,00 €
52514	320	84,00 €
52515	70, 216	9,10 €
52516	98	28,00 €
52517	98	6,00 €
52518	201	115,00 €
52519	36, 345	25,50 €
52524	53	51,00 €
52525	53	13,80 €
52526	53	28,40 €
52527	151	82,00 €
52528	155	49,00 €
52530	361	14,00 €
52533	161, 182	10,00 €
52534	361	15,00 €
52535	361	16,50 €
52536	130	57,00 €
52538	31	62,00 €
52539	31	59,00 €
52540	159, 182	221,00 €
52541	222	45,00 €
52542	99	109,00 €
52543	160	182,00 €
52544	175	93,00 €
52545	175	177,00 €
52546	171	39,60 €
52547	168	96,00 €
52550	30	92,00 €
52551	242	151,00 €
52552	372	128,00 €
52555	134	2,38 €
52558	134	2,38 €
52565	63	11,50 €
52566	140	28,00 €
52567	140	29,00 €
52568	141	28,00 €
52569	141	28,00 €

REF.	PÁGINA	PRECIO
52570	375	2,60 €
52571	375	2,60 €
52572	375	2,60 €
52573	375	2,60 €
52574	152	69,00 €
52575	68, 160	119,00 €
52583	69	8,50 €
52587	50	39,90 €
52588	50	45,00 €
52591	214	12,00 €
52592	214	22,00 €
52593	214	34,00 €
52595	68	64,00 €
52596	67	114,00 €
52597	67	146,00 €
52598	121, 340	1.080,00 €
52599	210	230,00 €
52600	342	884,00 €
52601	304	397,00 €
52603	28	74,00 €
52604	28	78,00 €
52605	28	76,00 €
52606	28	88,00 €
52607	203	49,00 €
52608	203	44,00 €
52609	68	29,00 €
52615	201	112,00 €
52616	296	44,00 €
52617	204	7,00 €
52618	365	29,00 €
52619	59	23,10 €
52620	31	8,80 €
52621	232	11,00 €
52624	241	28,00 €
52625	60, 198	9,00 €
52626	238	46,00 €
52627	238	120,00 €
52628	308	26,50 €
52629	208	99,00 €
52633	359	1,00 €
52634	91	5,25 €
52635	91	4,80 €
52636	194	114,00 €
52637	229	48,00 €
52638	69	9,95 €
52639	209	123,00 €
52640	225	52,00 €
52641	225	55,00 €
52642	228	32,00 €
52643	339	596,00 €
52644	360	8,80 €
52645	371	0,55 €
52646	371	0,50 €
52648	158	9,00 €
52649	370	5,00 €
52650	370	5,00 €
52652	369	2,80 €

REF.	PÁGINA	PRECIO
52653	369	3,00 €
52655	371	39,70 €
52656	371	39,50 €
52657	371	37,50 €
52658	371	39,70 €
52659	371	39,70 €
52660	372	126,00 €
52662	370	36,50 €
52663	370	30,00 €
52664	372	168,00 €
52665	368	0,37 €
52666	368	0,36 €
52667	368	0,76 €
52668	368	1,49 €
52669	368	2,22 €
52670	368	2,95 €
52671	368	3,70 €
52672	368	4,45 €
52673	370	18,00 €
52675	154	84,00 €
52676	154	98,00 €
52677	202	17,00 €
52678	202	18,00 €
52685	210	88,00 €
52687	218	168,00 €
52690	215	54,00 €
52691	232	54,00 €
52692	324	129,00 €
52693	213	24,50 €
52694	168	49,00 €
52696	213	12,00 €
52697	213	16,00 €
52699	228	22,00 €
52700	70	20,50 €
52703	384	22,00 €
52711	383	27,50 €
52714	33	15,70 €
52715	33	10,00 €
52716	33	15,90 €
52717	33	11,00 €
52718	152	48,00 €
52719	389	0,19 €
52722	22	87,00 €
52724	151	381,00 €
52725	151	349,00 €
52727	239	34,60 €
52728	239	68,00 €
52729	239	128,00 €
52730	239	288,00 €
52731	239	38,00 €
52732	239	58,00 €
52733	239	98,00 €
52734	213	51,00 €
52735	166	4,85 €
52736	166	5,35 €
52737	166	5,50 €
52738	375	5,00 €

REF.	PÁGINA	PRECIO
52739	375	5,00 €
52740	184	690,00 €
52749	189	79,00 €
52753	30	107,00 €
52754	204	54,00 €
52757	209	16,00 €
52758	154	88,00 €
52760	70, 216	4,10 €
52761	61	8,00 €
52762	61	9,00 €
52765	185	21,70 €
52768	356	13,80 €
52769	356	14,50 €
52770	356	23,00 €
52771	356	23,40 €
52772	356	13,90 €
52773	356	14,60 €
52774	356	14,80 €
52775	356	15,20 €
52776	356	13,80 €
52777	356	15,50 €
52778	356	14,60 €
52779	356	17,10 €
52780	356	13,90 €
52781	356	14,60 €
52782	356	14,80 €
52783	356	15,20 €
52786	64	14,60 €
52787	157	9,00 €
52788	181	39,00 €
52789	308	15,20 €
52791	58, 59	18,00 €
52794	69	28,00 €
52795	354	5,80 €
52796	228	98,00 €
52797	305	198,00 €
52798	156	18,00 €
52801	212	26,00 €
52802	226	54,00 €
52804	309	343,00 €
52805	309	426,00 €
52806	309	742,00 €
52807	309	1.714,00 €
52809	201	8,50 €
52810	170	9,00 €
52811	170	9,90 €
52812	59	65,00 €
52813	212	79,00 €
52814	149	528,00 €
52815	208	110,00 €
52816	232	28,10 €
52817	232	23,50 €
52819	216	22,00 €
52821	212	28,80 €
52822	230	32,00 €
52823	226	124,00 €
52827	138	46,00 €

REF.	PÁGINA	PRECIO
52828	138	43,00 €
52829	222	19,00 €
52830	64	24,00 €
52831	64	18,00 €
52832	215	75,00 €
52833	237	39,30 €
52834	224	195,00 €
52835	224	272,00 €
52836	184	1.100,00 €
52838	142	56,00 €
52839	142	64,00 €
52842	372	11,00 €
52843	139	31,60 €
52845	323	170,00 €
52846	57	37,80 €
52847	57	41,00 €
52849	230	8,50 €
52850	215	7,80 €
52851	181, 395	9,65 €
52852	230	6,80 €
52858	206	298,00 €
52862	357	1,15 €
52864	357	1,20 €
52865	357	0,50 €
52866	357	0,25 €
52869	100	52,00 €
52870	100	100,00 €
52871	100	258,00 €
52873	69	11,00 €
52874	225	82,00 €
52875	225	79,00 €
52876	180	182,00 €
52877	64	15,80 €
52878	64	11,20 €
52879	64	10,10 €
52880	47	42,00 €
52881	47	17,00 €
52882	213	14,00 €
52884	329	73,00 €
52885	64	18,00 €
52886	396	18,00 €
52887	396	22,00 €
52888	400	24,00 €
52889	398	19,00 €
52890	399	22,00 €
52891	398	28,00 €
52892	399	22,00 €
52893	400	26,00 €
52894	398	22,00 €
52895	400	22,00 €
52896	396	26,00 €
52897	399	38,00 €
52898	399	36,00 €
52899	397	34,00 €
52900	397	34,00 €
52901	397	34,00 €
52902	342	970,00 €

REF.	PÁGINA	PRECIO
52903	342	1.100,00 €
52904	69	61,00 €
52905	70	28,00 €
52906	196	38,00 €
52908	34	17,00 €
52909	34	12,50 €
52910	138	39,00 €
52912	45, 87	91,00 €
52913	51	292,00 €
52914	177	223,00 €
52915	177	199,00 €
52916	177	218,00 €
52917	177	122,00 €
52918	177	146,00 €
52919	177	181,00 €
52920	177	155,00 €
52921	177	117,00 €
52922	177	180,00 €
52923	177	59,00 €
52924	177	52,00 €
52925	177	176,00 €
52926	177	201,00 €
52927	177	59,00 €
52928	177	172,00 €
52929	177	185,00 €
52930	178	117,00 €
52931	178	45,00 €
52932	178	45,00 €
52933	178	194,00 €
52934	178	102,00 €
52935	178	94,00 €
52936	178	199,00 €
52937	178	265,00 €
52938	178	199,00 €
52939	178	28,00 €
52940	178	235,00 €
52941	178	70,00 €
52942	178	105,00 €
52943	178	75,00 €
52944	178	110,00 €
52945	178	281,00 €
52952	331, 344	74,00 €
52953	152	38,00 €
52955	61	19,80 €
52956	61	19,60 €
52957	61	23,80 €
52958	61	28,20 €
52959	61	42,00 €
52960	61	46,00 €
52962	226	42,00 €
52963	217	49,00 €
52964	56	9,45 €
52965	56	9,20 €
52966	56	9,45 €
52967	56	9,40 €
52969	172	20,70 €
52973	42	59,00 €

REF.	PÁGINA	PRECIO
52977	182	137,00 €
52980	335	480,00 €
52982	60, 186	53,00 €
52985	322	598,00 €
52987	132	20,00 €
52991	311	10,50 €
52992	311	18,00 €
52998	185	48,00 €
52999	321	178,00 €
53001	217	242,00 €
53007	357	0,42 €
53008	201	15,50 €
53009	209	42,00 €
53010	54	18,00 €
53017	38	57,00 €
53018	40	119,00 €
53025	69	3,50 €
53026	69	5,80 €
53027	69	9,00 €
53028	331	5,80 €
53029	331	6,80 €
53030	331	12,00 €
53031	100	59,00 €
53032	100	126,00 €
53033	364	21,50 €
53037	371	0,50 €
53038	371	0,50 €
53039	371	0,50 €
53040	371	0,50 €
53041	235	37,60 €
53042	69	9,90 €
53043	175	53,00 €
53044	175	121,00 €
53045	140	35,00 €
53046	140	39,00 €
53047	141	330,00 €
53048	141	89,00 €
53049	140	89,00 €
53051	141	158,00 €
53052	140	158,00 €
53053	215	12,00 €
53054	238	6,00 €
53055	236	33,00 €
53056	241	127,00 €
53057	217	149,00 €
53058	241	193,00 €
53059	242	52,00 €
53060	170	34,90 €
53062	240	99,00 €
53063	162	36,70 €
53064	162	37,40 €
53065	162	36,90 €
53066	162	61,00 €
53067	162	61,00 €
53068	162	63,00 €
53069	208	98,00 €
53070	48	16,20 €

REF.	PÁGINA	PRECIO
53071	48	26,10 €
53072	48	31,60 €
53073	48	50,00 €
53074	17	78,00 €
53077	174	62,00 €
53078	310	18,00 €
53079	189	89,00 €
53080	189	99,00 €
53081	52	115,00 €
53082	52	148,00 €
53083	65	64,00 €
53084	34	24,00 €
53085	135	30,00 €
53086	238	9,00 €
53087	356	11,20 €
53088	356	11,50 €
53089	356	11,50 €
53090	356	11,50 €
53091	356	10,20 €
53092	356	10,20 €
53093	356	10,20 €
53094	356	10,20 €
53095	66	20,50 €
53096	209	28,80 €
53108	22	92,00 €
53110	181, 395	27,30 €
53111	332	19,00 €
53112	314	298,00 €
53118	230	231,00 €
53119	213	52,00 €
53120	65	6,00 €
53121	65	7,35 €
53122	65	9,50 €
53124	188	287,00 €
53125	188	477,00 €
53126	189	243,00 €
53127	34	12,00 €
53129	216	84,00 €
53134	189	144,00 €
53137	155	38,00 €
53140	152	98,00 €
53141	155	68,00 €
53144	307	18,00 €
53145	332	39,20 €
53146	239	30,50 €
53147	163	41,00 €
53150	369	24,00 €
53151	143	14,00 €
53154	36, 345	462,00 €
53156	32	26,20 €
53159	25	289,00 €
53162	332	60,00 €
53164	36, 345	16,50 €
53165	36, 345	19,60 €
53166	339	10,50 €
53167	339	12,50 €
53168	339	19,00 €

REF.	PÁGINA	PRECIO
53177	356	11,90 €
53178	356	12,20 €
53179	356	12,20 €
53180	356	12,20 €
53181	356	11,90 €
53182	356	12,20 €
53183	356	12,70 €
53184	356	12,20 €
53185	355	13,20 €
53186	355	13,20 €
53187	311	39,00 €
53188	311	7,00 €
53189	337	128,00 €
53190	337	98,00 €
53191	98	14,80 €
53192	98	52,00 €
53196	192	33,00 €
53197	174	46,00 €
53198	311	9,50 €
53200	318	69,00 €
53202	160	15,70 €
53203	357	0,46 €
53204	160	81,00 €
53205	157	19,00 €
53206	202	38,20 €
53207	225	118,00 €
53208	225	126,00 €
53209	329	8,50 €
53210	48	48,00 €
53211	99	75,00 €
53212	16	174,00 €
53214	309	285,00 €
53215	307	19,00 €
53216	130	49,00 €
53217	132	47,00 €
53218	318	26,00 €
53220	334	260,00 €
53221	365	4,75 €
53224	180	142,00 €
53225	56	3,50 €
53226	192	14,90 €
53227	135	28,00 €
53229	388	38,70 €
53230	183	19,70 €
53232	185	39,00 €
53235	203	10,40 €
53236	203	11,50 €
53237	203	12,90 €
53238	203	18,40 €
53240	234	58,00 €
53241	361	9,00 €
53246	324	1.144,00 €
53249	231	192,00 €
53250	208	85,00 €
53251	213	88,00 €
53253	96	98,00 €
53256	368	34,00 €

REF.	PÁGINA	PRECIO
53259	249	97,00 €
53260	249	168,00 €
53261	249	214,00 €
53262	250	251,00 €
53263	250	57,00 €
53264	250	143,00 €
53265	251	195,00 €
53266	251	224,00 €
53267	251	277,00 €
53268	258	92,00 €
53269	252	50,00 €
53270	270	70,00 €
53271	270	227,00 €
53272	271	195,00 €
53273	271	75,00 €
53274	284	30,50 €
53275	284	35,50 €
53276	285	160,00 €
53277	285	45,00 €
53278	285	143,00 €
53279	286	97,00 €
53280	286	112,00 €
53281	286	55,00 €
53282	287	48,00 €
53283	287	92,00 €
53284	287	306,00 €
53285	288	56,00 €
53286	288	87,00 €
53287	288	245,00 €
53288	289	72,00 €
53289	274	45,00 €
53290	274	51,00 €
53291	274	68,00 €
53292	275	116,00 €
53293	261	134,00 €
53294	261	119,00 €
53295	262	77,00 €
53296	262	60,00 €
53297	267	45,00 €
53298	267	91,00 €
53299	278	291,00 €
53300	278	41,00 €
53301	278	44,00 €
53302	279	44,00 €
53303	244	89,00 €
53304	244	279,00 €
53305	279	136,00 €
53306	244	53,00 €
53307	279	38,50 €
53308	245	55,00 €
53309	245	285,00 €
53310	245	498,00 €
53311	275	97,00 €
53312	246	127,00 €
53313	258	139,00 €
53314	258	98,00 €
53315	295	285,00 €

REF.	PÁGINA	PRECIO
53316	280	34,00 €
53317	280	34,00 €
53318	261	24,00 €
53319	246	18,00 €
53320	289	12,00 €
53321	289	10,50 €
53324	264	12,50 €
53325	289	7,50 €
53326	290	16,00 €
53327	290	11,00 €
53328	226	76,00 €
53330	212	38,00 €
53331	67	31,80 €
53332	67	34,50 €
53339	70	9,50 €
53340	388	86,00 €
53343	149	285,00 €
53346	50	18,00 €
53347	205	100,00 €
53348	382	14,00 €
53349	392	14,00 €
53350	382	14,00 €
53351	384	12,50 €
53352	390	12,00 €
53353	387	18,00 €
53354	384	14,00 €
53355	393	11,50 €
53356	393	11,50 €
53357	394	7,00 €
53358	390	11,50 €
53359	390	16,00 €
53360	384	18,00 €
53361	384	24,00 €
53362	385	14,00 €
53363	382	34,00 €
53364	382	16,00 €
53365	385	14,00 €
53366	385	14,00 €
53367	393	9,50 €
53368	393	9,00 €
53369	385	14,00 €
53370	393	26,00 €
53371	383	29,00 €
53372	383	26,00 €
53373	383	14,50 €
53374	392	10,00 €
53376	392	10,50 €
53377	386	20,00 €
53378	390	13,00 €
53380	393	11,50 €
53381	390	14,50 €
53382	383	11,00 €
53383	383	11,50 €
53384	225	165,00 €
53385	61, 394	19,30 €
53388	233	90,00 €
53389	57	31,50 €

REF.	PÁGINA	PRECIO
53390	58	34,50 €
53391	234	86,00 €
53393	234	118,00 €
53394	223	598,00 €
53395	218	16,00 €
53396	58	18,30 €
53399	92	3,50 €
53400	92	5,70 €
53401	92	7,40 €
53402	92	9,60 €
53403	92	6,50 €
53404	92	6,50 €
53405	92	5,30 €
53406	92	8,55 €
53407	92	12,70 €
53408	92	19,30 €
53409	92	9,00 €
53410	217	92,00 €
53411	60	5,00 €
53412	60	4,00 €
53414	333	49,00 €
53415	333	188,00 €
53416	158	14,10 €
53417	158	26,30 €
53418	158	16,90 €
53419	372	9,70 €
53420	44	72,00 €
53421	315	298,00 €
53422	314	368,00 €
53423	323	199,00 €
53426	217	39,80 €
53427	134	5,00 €
53428	139	18,00 €
53429	139	18,00 €
53430	178	286,00 €
53434	392	18,00 €
53441	201	9,80 €
53444	27	195,00 €
53445	60	17,10 €
53449	158	16,40 €
53450	158	28,30 €
53452	280	26,50 €
53453	218	7,00 €
53456	220	98,00 €
53459	221	66,00 €
53463	242	98,00 €
53464	209, 387	153,00 €
53468	52	8,50 €
53470	171	176,00 €
53472	204	12,00 €
53473	204	36,00 €
53474	234	94,00 €
53477	217	36,10 €
53478	52	4,55 €
53479	52	6,40 €
53480	52	19,90 €
53481	52	27,40 €

REF.	PÁGINA	PRECIO
53484	332	615,00 €
53485	205	140,00 €
53486	183	29,30 €
53487	59	16,70 €
53488	229	61,00 €
53489	211	68,00 €
53490	209	275,00 €
53492	163, 410	380,00 €
53499	220	29,00 €
53500	220	29,00 €
53501	209	24,00 €
53502	236	38,70 €
53503	338	12,00 €
53504	410	38,00 €
53505	135	77,00 €
53506	135	36,00 €
53507	354	27,00 €
53508	365	14,00 €
53517	64	9,50 €
53518	310	3,50 €
53519	130	42,00 €
53520	146	228,00 €
53522	209	24,00 €
53523	275	91,00 €
53524	237	51,00 €
53525	182	12,00 €
53526	338, 348	119,00 €
53531	169	109,00 €
53532	164, 348	119,00 €
53533	409	1,50 €
53536	143	34,00 €
53537	204	14,50 €
53538	204	14,50 €
53539	219	66,00 €
53541	152	168,00 €
53542	159, 372	980,00 €
53543	337	13,80 €
53545	180	35,70 €
53547	56	14,70 €
53548	56	15,60 €
53549	56	14,30 €
53550	56	14,70 €
53551	374	16,00 €
53552	374	16,00 €
53553	374	16,00 €
53561	365	28,00 €
53565	24	258,00 €
53566	304	32,00 €
53567	161	43,00 €
53568	133	12,00 €
53569	133	18,00 €
53570	136	154,00 €
53572	161	348,00 €
53573	151	36,00 €
53574	31	47,00 €
53575	55	16,00 €
53576	153	189,00 €

REF.	PÁGINA	PRECIO
53581	164, 348	119,00 €
53582	164, 348	174,00 €
53583	164, 348	174,00 €
53584	338, 348	119,00 €
53585	338, 348	168,00 €
53586	338, 348	168,00 €
53587	173	44,00 €
53588	146	178,00 €
53589	70	12,00 €
53590	321	1.190,00 €
53591	64	5,50 €
53592	312	25,00 €
53593	160	41,00 €
53594	163	54,00 €
53595	163	61,00 €
53596	376	3,65 €
53597	376	3,70 €
53598	376	3,95 €
53599	221, 389	30,30 €
53602	61	30,50 €
53603	61	45,00 €
53604	61	118,00 €
53605	372	141,00 €
53606	158	55,00 €
53608	148	98,00 €
53609	302	182,50 €
53610	302	294,00 €
53611	156	27,50 €
53612	310	96,00 €
53613	68	19,50 €
53614	68	21,50 €
53615	68	34,60 €
53616	68	10,40 €
53617	68	9,25 €
53618	68	13,90 €
53620	89	88,00 €
53621	355	2,50 €
53622	355	2,50 €
53623	355	2,50 €
53624	355	2,50 €
53625	160	68,00 €
53626	154, 184	18,00 €
53627	305	22,50 €
53629	164	14,30 €
53630	164	18,80 €
53631	164	33,50 €
53632	164	46,00 €
53633	164	46,00 €
53634	164	63,00 €
53635	225	85,00 €
53636	354	22,00 €
53637	215	85,00 €
53638	222	243,00 €
53639	47	28,60 €
53640	47	34,40 €
53641	47	41,00 €
53642	47	54,00 €

REF.	PÁGINA	PRECIO
53643	47	92,00 €
53644	303	1.238,00 €
53645	303	268,00 €
53646	153	69,00 €
53648	290	107,00 €
53649	291	89,00 €
53650	212	47,00 €
53651	280	91,00 €
53652	237	53,00 €
53653	264	207,00 €
53654	47	81,00 €
53655	182	12,00 €
53656	334	198,00 €
53657	334	248,00 €
53658	334	99,00 €
53659	334	121,00 €
53660	334	146,00 €
53661	77	790,00 €
53662	214	89,00 €
53663	235	8,00 €
53664	238	38,00 €
53665	238	19,00 €
53666	238	28,00 €
53667	35	32,00 €
53668	35	34,00 €
53669	215	45,00 €
53670	202	29,50 €
53671	51, 89	41,00 €
53672	82	440,00 €
53673	183	80,00 €
53674	94	447,00 €
53675	186	50,00 €
53676	186	44,00 €
53677	186	55,00 €
53678	186	52,00 €
53681	149	743,00 €
53682	322	98,00 €
53683	196	116,00 €
53684	321	1.880,00 €
53685	189	310,00 €
53686	77	790,00 €
53687	328	298,00 €
53688	328	495,00 €
53689	147	238,00 €
53690	137	34,00 €
53691	137	36,00 €
53693	360	521,00 €
53694	54	18,40 €
53695	360	504,00 €
53696	209	22,00 €
53697	302	398,00 €
53698	360	717,00 €
53701	240	188,00 €
53702	97	28,50 €
53703	97	41,00 €
53704	97	42,00 €
53705	191	80,00 €

REF.	PÁGINA	PRECIO
53706	291	98,00 €
53707	136	153,00 €
53708	74, 76, 77, 83	325,00 €
53710	404	16,00 €
53711	404	16,00 €
53712	403	16,00 €
53713	403	16,00 €
53714	403	16,00 €
53715	402	19,00 €
53716	402	19,00 €
53717	402	19,00 €
53718	401	19,00 €
53719	401	19,00 €
53720	401	19,00 €
53721	355	18,80 €
53724	332	46,00 €
53725	314	248,00 €
53726	148	128,00 €
53727	23	198,00 €
53728	23	198,00 €
53729	184	19,10 €
53733	147	238,00 €
53734	130	23,70 €
53735	203	44,00 €
53736	189	98,00 €
53737	45	12,50 €
53738	45	10,90 €
53739	45	10,50 €
53740	45	9,10 €
53741	204	14,00 €
53742	223	1.325,00 €
53743	32, 175	39,70 €
53744	170	63,00 €
53745	362	6,40 €
53746	362	6,40 €
53747	362	6,40 €
53748	362	6,60 €
53749	362	6,70 €
53750	362	6,70 €
53751	362	6,80 €
53752	362	6,95 €
53753	362	7,10 €
53754	362	7,40 €
53755	362	7,50 €
53756	362	7,90 €
53757	362	7,90 €
53758	362	8,20 €
53759	362	8,50 €
53760	362	9,60 €
53761	77	490,00 €
53762	77	490,00 €
53767	77	790,00 €
53768	77	490,00 €
53769	80, 297, 300	178,00 €
53770	80, 298, 300	198,00 €
53771	80, 299, 300	158,00 €

REF.	PÁGINA	PRECIO
53772	80, 299, 300	229,00 €
53773	80, 297, 300	298,00 €
53774	80, 298, 300	190,00 €
53775	80, 300	1.109,00 €
53776	131	19,10 €
53778	354	4,50 €
53779	318	36,00 €
53780	132	14,50 €
53781	377	18,00 €
53782	96	14,00 €
53784	150	148,00 €
53785	376	4,80 €
53786	380	98,00 €
53791	378	4,80 €
53794	376	28,00 €
53796	380	76,00 €
53797	377	0,10 €
53802	380	120,00 €
53806	380	250,00 €
53808	379	16,50 €
53809	379	8,00 €
53811	379	8,90 €
53826	378	16,00 €
53827	378	32,00 €
53832	378	1,81 €
53838	380	38,00 €
53839	379	0,25 €
53845	318	64,00 €
53849	312	16,10 €
53850	123	14,90 €
53851	125	88,00 €
53852	125	207,00 €
53853	125	14,40 €
53854	125	27,00 €
53855	125	24,80 €
53856	125	62,00 €
53857	126	27,00 €
53858	126	28,80 €
53859	124	67,00 €
53860	124	3,65 €
53861	124	5,45 €
53862	377	6,00 €
53863	377	3,00 €
53864	369	138,00 €
53867	82	1.095,00 €
53868	74	1.090,00 €
53869	75	990,00 €
53870	75	990,00 €
53872	348	118,00 €
53873	307	285,00 €
53874	307	398,00 €
53875	216	134,00 €
53876	259	64,00 €
53877	411	430,50 €
53878	411	574,00 €
53879	411	838,50 €

REF.	PÁGINA	PRECIO
53880	320	598,00 €
53881	164, 348	79,00 €
53882	164, 348	79,00 €
53883	50	18,40 €
53884	50	30,20 €
53885	50	35,70 €
53886	50	20,30 €
53887	50	30,30 €
53888	50	37,90 €
53895	317	107,00 €
53896	317	127,00 €
53897	317	140,00 €
53898	317	148,00 €
53902	378	25,00 €
53903	97	59,00 €
53904	77	790,00 €
53905	56	7,30 €
53906	56	8,65 €
53908	56	7,25 €
53909	56	9,70 €
53910	392	19,00 €
53911	57	8,80 €
53912	75	1.280,00 €
53913	75	1.280,00 €
53914	379, 412	75,00 €
53915	22	65,00 €
53917	54	9,00 €
53919	363	81,00 €
53921	190	39,00 €
53922	190	29,00 €
53927	329	66,00 €
53928	26	278,00 €
53929	329	95,00 €
53932	61	8,00 €
53939	74	1.280,00 €
53940	79, 344, 346, 379	13,20 €
53942	79, 344, 346, 379	0,50 €
53943	54, 86	21,50 €
53944	54, 86	19,50 €
53945	54, 86	18,90 €
53946	377	0,83 €
53947	336	145,00 €
53948	336	324,00 €
53949	409	4,50 €
53950	409	4,50 €
53951	80, 300	1.794,00 €
53952	80, 300	1.794,00 €
53953	20	29,00 €
53954	45	8,50 €
53955	45	10,00 €
53956	408	353,00 €
53957	377	0,26 €
53958	98	6,50 €
53964	364	9,65 €
53965	364	25,80 €
53967	57	10,20 €

REF.	PÁGINA	PRECIO
53968	314	49,00 €
53969	323	96,00 €
53970	343	3.790,00 €
53972	52	550,00 €
53973	408	284,00 €
53974	134	38,00 €
53976	61	9,00 €
53977	332	17,50 €
53978	195	38,90 €
53979	45, 88	34,60 €
53980	45, 88	34,60 €
53981	333	143,00 €
53982	333	219,00 €
53983	188	215,00 €
53984	374	8,00 €
53985	374	8,00 €
53986	374	8,00 €
53987	344, 379	9,50 €
53988	173	101,00 €
53992	392	18,00 €
53993	66	77,00 €
53997	211	48,00 €
53999	127	2,00 €
54000	127	2,50 €
54001	317	285,00 €
54002	127	3,00 €
54003	238	104,00 €
54004	133	16,00 €
54005	46	14,00 €
54006	77	490,00 €
54008	127	3,50 €
54010	127	4,50 €
54011	127	5,00 €
54013	369	35,00 €
54015	57	10,20 €
54016	211	76,00 €
54017	182	12,00 €
54018	49	9,85 €
54019	49	17,90 €
54021	49	13,50 €
54022	49	9,95 €
54023	49	13,50 €
54024	49	17,90 €
54028	49	28,00 €
54029	49	28,00 €
54030	49	18,80 €
54031	49	19,30 €
54032	39, 88	84,00 €
54033	161	49,00 €
54034	9	178,00 €
54035	12	149,00 €
54036	13	99,00 €
54037	14	88,00 €
54038	15	88,00 €
54039	135	154,00 €
54040	330	240,00 €
54041	40	198,00 €

REF.	PÁGINA	PRECIO
54042	358	13,00 €
54043	408	48,00 €
54044	143	99,00 €
54045	9	179,00 €
54046	12	150,00 €
54047	13	100,00 €
54048	14	89,00 €
54049	15	89,00 €
54050	306	895,00 €
54051	308	39,00 €
54053	342	248,00 €
54054	342	268,00 €
54055	342	220,00 €
54056	342	260,00 €
54057	342	248,00 €
54058	342	348,00 €
54059	343	428,00 €
54060	55	6,00 €
54061	55	6,00 €
54066	39, 87	83,00 €
54068	200	120,00 €
54069	221	29,50 €
54070	55	18,00 €
54071	55	26,50 €
54072	358	38,50 €
54073	363	70,00 €
54074	363	18,50 €
54076	409	9,00 €
54078	144	68,00 €
54079	41	83,00 €
54080	96	53,50 €
54081	43	28,00 €
54082	11	189,00 €
54083	49	9,75 €
54084	49	13,10 €
54085	49	17,80 €
54086	49	9,25 €
54087	49	17,30 €
54088	135	132,00 €
54089	65	17,50 €
54090	21	56,00 €
54091	35, 345	441,00 €
54092	291	24,00 €
54093	35, 79, 87, 345, 346	441,00 €
54097	41	38,90 €
54098	47	158,50 €
54099	66	13,80 €
54100	302	265,00 €
54101	38	61,00 €
54105	21	33,00 €
54106	17, 46	89,00 €
54108	18	66,00 €
54109	20	34,00 €
54110	40	46,00 €
54111	333	4,75 €
54112	62	18,00 €
54113	333	7,65 €

REF.	PÁGINA	PRECIO
54114	79, 330, 346	248,00 €
54115	43	26,80 €
54116	18	66,00 €
54117	38	74,00 €
54119	44	78,00 €
54120	41	59,00 €
54122	131	38,00 €
54123	131	40,00 €
54124	131	47,00 €
54125	337	152,00 €
54126	54	39,00 €
54129	79, 346	110,00 €
54130	79, 345, 346	58,00 €
54131	345	58,00 €
54132	79, 346	190,00 €
54133	135	547,00 €
54134	78, 84	1.415,00 €
54135	197	82,00 €
54136	372	107,00 €
54137	315	288,00 €
54139	218	147,00 €
54140	17	36,00 €
54141	22	42,00 €
54142	62	15,20 €
54143	318	249,00 €
54144	318	298,00 €
54145	318	377,00 €
54146	318	492,00 €
54147	318	198,00 €
54149	42	60,00 €
54150	42	23,50 €
54151	374	9,00 €
54152	374	9,00 €
54153	374	9,00 €
54154	29	37,50 €
54155	374	8,00 €
54156	374	8,00 €
54157	374	8,00 €
54158	86	38,00 €
54159	43	47,00 €
54160L	143	17,50 €
54160R	143	17,50 €
54161	142	90,00 €
54162	142	81,00 €
54163	142	80,00 €
54164	29	34,00 €
54166	363	32,40 €
54168	20	49,00 €
54169	363	13,80 €
54170	363	16,50 €
54172	137	81,00 €
54173	137	87,00 €
54174	41	139,00 €
54175	326	34,00 €
54176	350	188,00 €
54177	374	16,00 €

REF.	PÁGINA	PRECIO
54178	374	16,00 €
54179	374	16,00 €
54181	310	25,10 €
54182	310	34,70 €
54183	310	38,20 €
54184	310	44,00 €
54186	206	250,00 €
54187	46	39,30 €
54188	376	19,00 €
54189	376	19,00 €
54190	376	19,00 €
54191	376	19,00 €
54192	375	8,90 €
54193	375	8,90 €
54194	375	8,90 €
54195	375	8,90 €
54198	372	59,00 €
54199	292	94,00 €
54200	296	56,00 €
54201	264	37,60 €
54202	246	68,00 €
54203	247	91,00 €
54204	265	124,00 €
54205	281	49,00 €
54206	252	113,00 €
54207	270	38,90 €
54208	265	76,00 €
54209	265	29,70 €
54210	276	84,00 €
54211	247	74,00 €
54212	247	39,40 €
54213	260	19,80 €
54214	281	96,00 €
54215	248	57,00 €
54216	248	49,00 €
54217	281	104,00 €
54218	292	142,00 €
54219	253	60,00 €
54220	208	197,00 €
54221	282	111,00 €
54222	253	59,00 €
54223	266	149,00 €
54224	266	64,50 €
54225	276	133,00 €
54226	295	71,00 €
54227	253	122,00 €
54228	254	187,00 €
54229	337	48,00 €
54230	337	68,00 €
54231	337	138,00 €
54232	337	248,00 €
54233	79, 346	1.856,00 €
54234	79, 346	1.856,00 €
54235	79, 346	1.856,00 €
54236	79, 346	1.856,00 €
54237	78	1.887,00 €
54238	78	1.887,00 €

REF.	PÁGINA	PRECIO
54239	78	1.887,00 €
54240	78	1.887,00 €
54241	79, 346	120,00 €
54246	182	104,00 €
54247	182	99,00 €
54248	158	58,00 €
54249	158	103,00 €
54250	10	188,00 €
54251	157	43,00 €
54252	340	199,00 €
54253	227	166,00 €
54254	62	43,00 €
54255	156, 312	68,00 €
54256	330	48,00 €
54257	319	318,00 €
54258	19	58,00 €
54260	266	277,00 €
54261	24	321,00 €
54262	323	88,00 €
54263	323	130,00 €
54264	323	240,00 €
54265	343	1.290,00 €
54266	29	39,50 €
54267	133	9,50 €
54269	51	56,00 €
54270	136	42,00 €
54271	136	54,00 €
54273	214	10,10 €
54274	214	11,00 €
54275	214	13,20 €
54277	19	53,50 €
54278	409	4,50 €
54279	58	6,00 €
54280	237	156,50 €
54288	259	72,50 €
54289	277	38,00 €
54290	306	4.307,00 €
54291	220	5.054,00 €
54293	254	17,50 €
54294	374	8,00 €
54295	81	500,00 €
54296	81	520,00 €
54297	81	540,00 €
54298	354	7,50 €
54299	227	227,00 €
54302	53	11,50 €
54304	50	26,00 €
54305	351	232,50 €
54306	352	219,50 €
54308	352	89,00 €
54309	352	71,00 €
54310	352	57,00 €
54311	58	13,00 €
54312	210	191,50 €
54313	126	43,00 €
54314	126	82,00 €
54316	172	182,00 €

REF.	PÁGINA	PRECIO
54317	226	124,00 €
54318	271	105,00 €
54321	343	898,00 €
54322	344, 379	19,00 €
54323	259	119,00 €
54324	257	11,00 €
54325	409	22,50 €
54326	79, 344, 346, 379	7,30 €
54327	72	2.788,00 €
54328	94	199,00 €
54329	371	37,50 €
54330	58	12,50 €
54331	65	27,00 €
54336	150	259,00 €
54338	39	60,00 €
54339	51	273,00 €
54340	147	296,00 €
54341	335	643,00 €
54342	335	858,00 €
54343	53	31,00 €
54344	132	10,50 €
54345	206	15,00 €
54346	127	11,50 €
54347	214	46,00 €
54348	126	291,00 €
54349	325	8,00 €
54350	325	12,50 €
54351	325	14,00 €
54352	325	18,00 €
54353	325	23,50 €
54354	325	34,50 €
54355	325	12,00 €
54356	326	19,50 €
54357	325	15,00 €
54358	325	18,50 €
54359	326	14,00 €
54360	325	14,00 €
54361	325	14,00 €
54362	326	14,00 €
54363	325	14,00 €
54364	326	14,00 €
54365	325	12,50 €
54366	326	18,50 €
54367	306	729,00 €
54368	219	2.329,00 €
54369	374	16,00 €
54370	374	16,00 €
54371	374	16,00 €
54372	198	157,00 €
54373	210	395,00 €
54374	96	75,50 €
54376	58	12,00 €
54379	131	28,00 €
54380	233	119,00 €
54381	233	5,00 €
54382	233	5,00 €
54383	233	5,00 €

REF.	PÁGINA	PRECIO
54384	222	32,50 €
54386	324, 346	5.839,00 €
54388	93	366,00 €
54389	76	790,00 €
54390	389	199,00 €
54391	207	221,00 €
54392	207	1.855,00 €
54393	95	92,00 €
54394	95	64,00 €
54395	95	53,00 €
54396	320	2.250,00 €
54397	147	249,00 €
54398	254	41,00 €
54399	255	56,50 €
54400	255	141,00 €
54401	255	57,00 €
54402	256	201,00 €
54403	256	225,00 €
54404	256	131,00 €
54405	257	111,00 €
54406	257	73,00 €
54407	292	59,50 €
54408	293	46,00 €
54409	293	32,00 €
54410	293	33,50 €
54411	294	36,00 €
54412	294	57,00 €
54413	294	115,00 €
54414	272	97,50 €
54415	272	60,00 €
54416	272	31,00 €
54417	273	153,00 €
54418	273	37,00 €
54419	262	57,00 €
54420	263	102,00 €
54421	263	52,00 €

REF.	PÁGINA	PRECIO
54422	267	140,00 €
54423	268	108,00 €
54424	263	64,50 €
54425	268	124,00 €
54426	268	69,00 €
54427	269	113,00 €
54428	269	31,00 €
54429	269	55,00 €
54430	248	34,00 €
54431	295	184,00 €
54432	260	43,00 €
54433	260	18,00 €
54434	282	48,50 €
54435	282	14,50 €
54436	283	124,00 €
54437	283	110,00 €
54438	277	40,00 €
54439	277	32,50 €
54479	59	36,50 €
54480	409	1,00 €
54482	334	677,00 €
54483	325	14,00 €
54484	325	26,00 €
54485	325	36,00 €
54486	325	9,50 €
54487	326	15,00 €
54488	325	15,00 €
54489	326	19,50 €
54490	326	15,00 €
54491	326	17,50 €
54492	326	19,50 €
54493	325	13,50 €
54494	325	14,00 €
54495	326	18,00 €
54496	326	16,50 €
54497	326	12,50 €

REF.	PÁGINA	PRECIO
54498	309	6.090,00 €
54501	80, 300	1.794,00 €
54502	80, 300	1.794,00 €
54503	76	490,00 €
54534	355	24,00 €
60001	116	88,00 €
60003	116	110,00 €
60004	117	79,00 €
60005	105	132,00 €
60006	106	182,00 €
60007	111	170,00 €
60009	108	168,00 €
60010	111	170,00 €
60011	112	175,00 €
60012	122	48,00 €
60013	122	80,00 €
60015	122	138,00 €
60016	122	49,00 €
60017	122	64,00 €
60019	110	178,00 €
60020	110	175,00 €
60022	112	470,00 €
60023	106	212,00 €
60024	105	190,00 €
60025	105, 122	31,60 €
60026	105, 122	379,00 €
60027	118	99,00 €
60028	109	142,00 €
60029	119	240,00 €
60030	119	112,00 €
60031	120	142,00 €
60032	113	123,00 €
60033	108	104,00 €
60035	117	30,00 €
60037	114	222,00 €
60038	113, 312	255,00 €

REF.	PÁGINA	PRECIO
60039	118	265,00 €
60040	120	440,00 €
60041	114	77,00 €
60042	115	106,00 €
60043	115	123,00 €
60044	103	330,00 €
60044C	103	485,00 €
60045	121	298,00 €
60046	102	174,00 €
60046C	102	339,00 €
60047C	107	318,00 €
60048	104	366,00 €
60048C	104	560,00 €
60049C	109	329,00 €
70001	406	35,00 €
70002	406	35,00 €
70003	406	35,00 €
70004	406	42,00 €
70005	406	42,00 €
70006	406	42,00 €
70009	406	35,00 €
70011	406	42,00 €
70012	406	42,00 €
70013	406	44,00 €
70014	406	44,00 €
70015	406	44,00 €
70016	406	44,00 €
70017	406	44,00 €
90003	160	35,20 €
90004	160	25,80 €
JBMW-BEXP	362	24,50 €
METEXP	361, 406, 410	62,00 €
SERIE124	360	710,00 €
SERIE262	154, 184	199,00 €





www.jbmcamp.com



JBMprofessionaltools



@jbmttools



jbmttools



JBM Campllong S.L.U.



CAT2024ES

8 435034 988895